

Manual



LED Control

LED Control Basic

LED constant current source

Item no. 53-00100

FB-11 | FB-12 | FB-13

Cab lighting

Item no. 53-00110 | 53-00120 | 53-00130

ZSB-2

Train rear lighting

Item no. 53-00180

tams elektronik



Table of contents

1. Getting started.....	3
2. Safety instructions.....	5
3. Safe and correct soldering.....	8
4. Operation overview.....	9
5. Technical specifications.....	11
6. Connections.....	12
7. Check list for troubleshooting.....	17
8. Guarantee bond.....	18
9. Declaration of conformity.....	19
10. Declarations conforming to the WEEE directive.....	19

© 12/2015 Tams Elektronik GmbH

All rights reserved. No part of this publication may be reproduced or transmitted in any form or by any means, electronic or mechanical, including photocopying, without prior permission in writing from Tams Elektronik GmbH.

Subject to technical modification.

1. Getting started

This manual applies to the following lighting modules, so for:

- LED Control^{Basic},
- train rear lighting ZSB-2,
- driver's cab lighting FB-11, FB-12 and FB-13.

Provided there are no other details given for particular sections, the information given applies to all modules.

How to use this manual

This manual gives step-by-step instructions for safe and correct fitting and connecting of the modules, and operation. Before you start, we advise you to read the whole manual, particularly the chapter on safety instructions and the checklist for trouble shooting. You will then know where to take care and how to prevent mistakes which take a lot of effort to correct.

Keep this manual safely so that you can solve problems in the future. If you pass the module on to another person, please pass on the manual with it.

Intended use

The modules are designed for mounting and use in model railroad vehicles driven in analogue or digital controlled layouts. Any other use is inappropriate and invalidates any guarantees.

The modules should not be mounted by children under the age of 14.

Reading, understanding and following the instructions in this manual are mandatory for the user.

Checking the package contents

	PCBs	Additional components, characteristics	CD (containing the manual and further information)
LED Control ^{Basic}	2	---	1
ZSB-2	2	2 LEDs shaped like train rear lanterns, nominal size TT - H0	1
FB-11	2	equipped with a yellow LED	1
FB-12	2	equipped with a pure white LED	1
FB-13	2	equipped with a warm white LED	1

Required materials

For mounting and connecting the module you need:

- an electronic soldering iron (max. 30 Watt) or a regulated soldering iron with a fine tip and a soldering iron stand,
- a tip-cleaning sponge,
- a heat-resistant mat,
- a small side cutter and wire stripper,
- as necessary a pair of tweezers and long nose pliers,
- thin connecting wire.

With LED Control^{Basic}: LEDs for the vehicle's lighting.

If required: a bridging capacitor ($\geq 100 \mu\text{F}$) with a voltage sustaining capability of

- $\geq 16 \text{ V}$ (when connected to a power supply $\leq 18 \text{ V}$) or
- $\geq 25 \text{ V}$ (when connected to a power supply $> 18 \text{ V}$).

2. Safety instructions

Mechanical hazards

Cut wires can have sharp ends and can cause serious injuries. Watch out for sharp edges when you pick up the PCB.

Visibly damaged parts can cause unpredictable danger. Do not use damaged parts: recycle and replace them with new ones.

Electrical hazards

- Touching powered, live components,
- touching conducting components which are live due to malfunction,
- short circuits and connecting the circuit to another voltage than specified,

impermissibly high humidity and condensation build up can cause serious injury due to electrical shock. Take the following precautions to prevent this danger:

- Never perform wiring on a powered module.
- Assembling and mounting the kit should only be done in closed, clean, dry rooms. Beware of humidity.
- Only use low power for this module as described in this manual and only use certified transformers.
- Connect transformers and soldering irons only in approved mains sockets installed by an authorised electrician.
- Observe cable diameter requirements.
- After condensation build up, allow a minimum of 2 hours for dispersion.
- Use only original spare parts if you have to repair the kit or the ready-built module.

Fire risk

Touching flammable material with a hot soldering iron can cause fire, which can result in injury or death through burns or suffocation. Connect your soldering iron or soldering station only when actually needed. Always keep the soldering iron away from inflammable materials. Use a suitable soldering iron stand. Never leave a hot soldering iron or station unattended.

Thermal danger

A hot soldering iron or liquid solder accidentally touching your skin can cause skin burns. As a precaution:

- use a heat-resistant mat during soldering,
- always put the hot soldering iron in the soldering iron stand,
- point the soldering iron tip carefully when soldering, and
- remove liquid solder with a thick wet rag or wet sponge from the soldering tip.

Dangerous environments

A working area that is too small or cramped is unsuitable and can cause accidents, fires and injury. Prevent this by working in a clean, dry room with enough freedom of movement.

Other dangers

Children can cause any of the accidents mentioned above because they are inattentive and not responsible enough. Children under the age of 14 should not be allowed to work with this kit or the ready-built module.

 **Caution:** Little children can swallow small components with sharp edges, with fatal results! Do not allow components to reach small children.

In schools, training centres, clubs and workshops, assembly must be supervised by qualified personnel.

In industrial institutions, health and safety regulations applying to electronic work must be adhered to.

3. Safe and correct soldering

 **Caution:** Incorrect soldering can cause dangers through fires and heat. Avoid these dangers by reading and following the directions given in the chapter **Safety instructions**.

- Use a small soldering iron with max. 30 Watt. Keep the soldering tip clean so the heat of the soldering iron is applied to the solder point effectively.
- Only use electronic tin solder with flux.
- When soldering electronic circuits never use soldering-water or soldering grease. They contain acids that can corrode components and copper tracks.
- Solder quickly: holding the iron on the joints longer than necessary can destroy components and can damage copper tracks or soldering eyes.
- Apply the soldering tip to the soldering spot in such a way that the wire and the soldering eye are heated at the same time. Simultaneously add solder (not too much). As soon as the solder becomes liquid take it away. Hold the soldering tip at the spot for a few seconds so that the solder flows into the joint, then remove the soldering iron.
- The joint should be held still for about 5 seconds after soldering.
- To make a good soldering joint you should use a clean and unoxidised soldering tip. Clean the soldering tip with a damp piece of cloth, a damp sponge or a piece of silicon cloth.
- After soldering check (preferably with a magnifying glass) tracks for accidental solder bridges and short circuits. This would cause faulty operation or, in the worst case, permanent damage. You can remove excess solder by putting a clean soldering tip on the spot. The solder will become liquid again and flow from the soldering spot to the soldering tip.

4. Operation overview

LED Control^{Basic}

On the PCB are integrated a constant current source, a rectifier and connecting points for a bridging capacitor.

Constant current source: A transistor ensures, that during operation a constant current of approximately 20 mA is available. This allows LEDs to be connected directly without series resistors. They have a constant brightness after reaching the required minimum voltage, independent from the voltage supplied. The minimum voltage for blue and white LEDs is approx. 4 V, for different-coloured LEDs approx. 3 V.

Rectifier: When connecting the PCB to analogue a.c. voltage or digital voltage (so the function output of a vehicle decoder) the integrated rectifier brings the LEDs to light in both directions of travel. When connecting the PCB to analogue d.c. voltage an additional bridge rectifier is required, when required that the LEDs light in both directions of travel.

Connecting points for a bridging capacitor: Connecting a bridging capacitor prevents the connected LEDs from flickering at short current interruptions (e.g. when passing points). With an adequate dimensioning of the capacitor the LEDs can also be supplied in longer currentless sections.

Connecting LEDs

You can connect one LED or several LEDs in series to one LED Control^{Basic}. The maximum number of LEDs to be connected depends on the voltage supplied and the fluorescent colour of the LEDs.

Connecting train rear lanterns

When using the LED Control^{Basic} with the train rear lighting (ZSB-2) it is recommended to connect each LED (train rear lantern) via a PCB to the carriage's back board. It is possible as well to connect several train rear lanterns or one train rear lantern and further LEDs in series to one LED Control^{Basic}.

Driver's cab lighting

The driver's cab lighting is designed like the LED Control^{Basic}, but is equipped additionally with a SMD-LED. Like the LED Control^{Basic} there is integrated a LED constant current source and it is possible to connect a bridging capacitor and an additional rectifier. It is not possible to connect further LEDs.

The LEDs shine in the following colours:

FB-11: yellow

FB-12: pure white

FB-13: warm white

5. Technical specifications

Supply voltage	analogue a.c. or d.c. voltage or digital voltage
Minimum voltage	appr. 3 V (yellow, red, green LEDs) or 4 V (white, blue LEDs)
Maximum voltage	20 V a.c. voltage or 24 V d.c. digital voltage
Current consumption (appr.)	20 mA
Connection for buffer capacitor	1
Capacity	min. 100 μ F
Electric strength	
- voltage supply \leq 18 V	min. 16 V
- voltage supply $>$ 18 V	min. 25 V
Protected to	IP 00
Ambient temperature in use	0 ... +60 °C
Ambient temperature in storage	-10 ... +80 °C
Comparative humidity allowed	max. 85 %
Dimensions of the PCB (approx.)	7.5 x 6.5 mm
Weight of PCB:	
LED ControlBasic	appr. 0.11 g
Driver 's cab lighting	appr. 0.14 g

6. Connections

Preliminary work

Before mounting the PCB into the vehicle you should carry out all required soldering:

- wires for the connection to the power supply;
- if required: connecting wires for external LEDs;
- if required: additional bridging capacitor;
- if required: additional rectifier.

 While soldering avoid heating plastic parts of locomotives and carriages. Parts might go out of shape!

Connection diagram

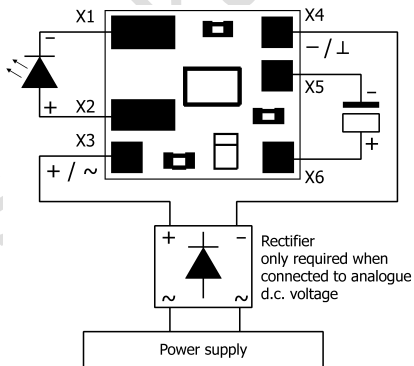

Connection to (analogue) a.c. voltage

When connecting the PCB to (analogue) a.c. voltage, the connections' polarity is not relevant. The LEDs shine independently of the direction of travel.

Connection to (analogue) d.c. voltage

When connecting the PCB to (analogue) d.c. voltage, you have to observe the connections' polarity. The LEDs shine in one direction of travel only when connected to (analogue) d.c. voltage. If they have to work in both directions of travel, mount an additional bridge rectifier (e.g. item no. 83-19100-10, not included in delivery) according to the connection diagram.

Connection to a decoder output

Connect the connecting point X4 on the PCB to the appropriate output of the locomotive or function decoder. Connect the connecting point X3 to the return conductor of the output or the return conductor for all outputs.

Alternatively you can connect the connecting point X3 to the vehicle's housing ground. Please note that in this case the LEDs flicker due to principle when the decoder is controlled in Motorola format.

Info: Light emitting diodes (LEDs)

When operated in the forward direction the LEDs light. They are available in several different versions (differing in colour, size, form, luminosity, maximum current, voltage limits). The longer lead of wired LEDs (**not** with LEDs for ZSB-2) is normally the anode (positive pole). With SMD-LEDs the cathode normally is shown by a mark on the housing.

When using LEDs you always have to limit the current conduction (e.g. by mounting a series resistor), otherwise they will be damaged after a short operating duration. The LED Control^{Basic} has an integrated constant current source limiting the current at the output to 20 mA. Thus it is possible to connect LEDs directly (without series resistor).

Connecting LEDs

You can connect one LED or several LEDs in series directly (without series resistor) to one LED Control^{Basic}. The maximum number of LEDs you can connect to one PCB depends on the voltage supplied and the fluorescent colour of the LEDs.

Notice: It is not possible to connect external LEDs to a driver's cab lighting.



Caution: The legs of a LED should not be mounted crosswise to avoid short circuits!

Maximum number of LEDs per PCB connected in series

Forward voltage of the LEDs*1	Nominal / operating voltage of the transformer (=)*2	Max. number of LEDs*3	Nominal / operating voltage of the transformer (~)*2	Max. number of LEDs*3
2 V	12 V / 12 V	5	12 V / approx. 17 V	7
4 V	12 V / 12 V	2	12 V / approx. 17 V	3
2 V	16 V / 16 V	7	16 V / approx. 22 V	10
4 V	16 V / 16 V	3	16 V / approx. 22 V	5
2 V	18 V / 18 V	8	18 V / approx. 25 V	11
4 V	18 V / 18 V	4	18 V / approx. 25 V	5

*1 The forward voltage of white and blue LEDs is approx. 4 V, differing coloured LEDs approx. 2 V.

*2 Nominal voltage and operating voltage: The operating voltage with a.c. transformers is approx. 1,4 times the nominal voltage given on the transformer. With d.c. power packs the operating voltage corresponds to the given nominal voltage.

*3 Tolerance and / or voltage fluctuations in practice often cause the calculated operating voltage not being available. For that reason it is recommended to connect one LED less than possible in theory.

Connect the LED(s) according to the connection diagram to the connecting points X1 and X2.

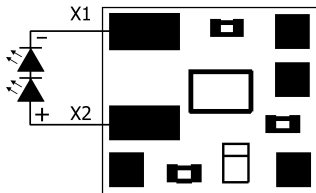

Connecting train rear lanterns:

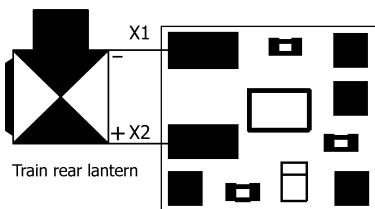

Caution:

The LEDs shaped like train rear lanterns have to be mounted according to the connection diagram! The longer lead is **not** in general the anode (+)!

Mounting the train rear lanterns

In order to fix a LED shaped like a train rear lantern safely, it is recommended to use a PCB of its own for each LED.

Fix the PCB on the inside of the carriage's board beside the holes needed to feed through the legs of the LED. Take care to mount the connecting points for the LED directly beside the holes. Bend the legs of the LED in direction of the PCB, when fed through the hole. Shorten the legs so that they end directly above the connecting points and then solder them.

Note: The LED should be mounted with a small distance to the back of the carriage like in reality. Use a match as a spacer while mounting the LED.

Info: Electrolytic capacitors

Electrolytic capacitors are often used to store energy. One of the two leads is marked with a minus sign which indicates the mounting orientation. The value is given on the casing.

Electrolytic capacitors are available with different voltage sustaining capabilities and capacities. The maximum capacity only depends on the space available for mounting the capacitor (the higher the capacity the bigger the capacitor). Using an electrolytic capacitor with a voltage sustaining capability higher than required is always possible.

Connecting a bridging capacitor

In order to supply the LEDs in currentless parts you can mount an additional capacitor to the PCB. It is recommended to choose a capacitor with a capacity as high as possible. The minimum voltage sustaining capability of the capacitor depends on the power supply:

Power supply	Voltage sustaining capability of the bridging capacitor
$\leq 18 \text{ V}$	$\geq 16 \text{ V}$
$> 18 \text{ V}$	$\geq 25 \text{ V}$

Please note: When connecting the PCB to a decoder output intended to be dimmed, you should not mount a bridging capacitor.

7. Check list for troubleshooting

- Parts are getting very hot and/or start to smoke.



Disconnect the system from the mains immediately!

Possible cause: The connections to the power supply are connected the wrong round. → Check the connection. In this case the PCB and the connected LEDs are probably damaged irreparably.

- The LED(s) does / do not light.

Possible cause: The connection to the power supply is interrupted. → Check the connections.

Possible cause: If connected to direct (analogue) voltage the connections "+" and "-" are incorrectly connected. → Check the connections.

- The LED(s) only lights / light in one direction of motion.

Possible cause: There is no rectifier mounted in series although connected to direct voltage. → Mount a rectifier.

Hotline: If problems with your module occur, our hotline is pleased to help you (mail address on the last page).

Repairs: You can send in a defective module for repair (address on the last page). In case of guarantee the repair is free of charge for you. With damages not covered by guarantee, the maximum fee for the repair is 50 % of the sales price according to our valid price list. We reserve the right to reject the repairing of a module when the repair is impossible for technical or economic reasons.

Please do not send in modules for repair charged to us. In case of warranty we will reimburse the forwarding expenses up to the flat rate we charge according to our valid price list for the delivery of the product. With repairs not covered by guarantee you have to bear the expenses for sending back and forth.

8. Guarantee bond

For this product we issue voluntarily a guarantee of 2 years from the date of purchase by the first customer, but in maximum 3 years after the end of series production. The first customer is the consumer first purchasing the product from us, a dealer or another natural or juristic person reselling or mounting the product on the basis of self-employment. The guarantee exists supplementary to the legal warranty of merchantability due to the consumer by the seller.

The warranty includes the free correction of faults which can be proved to be due to material failure or factory flaw. With kits we guarantee the completeness and quality of the components as well as the function of the parts according to the parameters in not mounted state. We guarantee the adherence to the technical specifications when the kit has been assembled and the ready-built circuit connected according to the manual and when start and mode of operation follow the instructions.

We retain the right to repair, make improvements, to deliver spares or to return the purchase price. Other claims are excluded. Claims for secondary damages or product liability consist only according to legal requirements.

Condition for this guarantee to be valid, is the adherence to the manual. In addition, the guarantee claim is excluded in the following cases:

- if arbitrary changes in the circuit are made,
- if repair attempts have failed with a ready-built module or device,
- if damaged by other persons,
- if damaged by faulty operation or by careless use or abuse.

9. Declaration of conformity

 This product conforms with the EC-directives mentioned below and is therefore CE certified.

2004/108/EG on electromagnetic. Underlying standards: EN 55014-1 and EN 61000-6-3. To guarantee the electromagnetic tolerance in operation you must take the following precautions:

- Connect the transformer only to an approved mains socket installed by an authorised electrician.
- Make no changes to the original parts and accurately follow the instructions, connection diagrams and PCB layout included with this manual.
- Use only original spare parts for repairs.

2011/65/EG on the restriction of the use of certain hazardous substances in electrical and electronic equipment (ROHS). Underlying standard: EN 50581.

10. Declarations conforming to the WEEE directive



This product conforms with the EC-directive 2012/19/EG on waste electrical and electronic equipment (WEEE).

Don't dispose of this product in the house refuse, bring it to the next recycling bay.

Information and tips:

<http://www.tams-online.de>

Warranty and service:

Tams Elektronik GmbH

Fuhrberger Straße 4

DE-30625 Hannover

fon: +49 (0)511 / 55 60 60

fax: +49 (0)511 / 55 61 61

e-mail: modellbahn@tams-online.de

