

# Elma TT

## Logistik GmbH

Raiffeisenstrasse 4  
89415 Lauingen  
Telefon: 09072/ 991956  
Telefax: 09072/ 991963  
e-mail: elmatt@ t-online.de

### Constructional data for isolating transformers and safety transformers:

- 1.1 Applicant : ELMA TT d.d. Ljubljana
- 1.2 Place of manufacture : Cesta 24. junija 23, SLO 1213 Ljubljana – Črnuče
- 1.3 Reference of type : PV/0-23033
- 1.4 Trade mark : CONRAD
- 1.5 Other markings : IZ3174 - Conrad Art. Nr. 408237
- 1.6 Europe standard : EN 61558 - 2 - 6

- 2.1 Protection against electric shock : Non short.circuit proof
- 2.2 Class of protection to IEC 529 : IP 00
- 2.3 Type of construction (Isolating transformer ) : Safety-isolating transformer
- 2.4 Stationary Transformer : Stationary, to built-in transformer  
Portable Transformer :
- 2.5 Protection against short-circuit according to Sub-clause  
inherently short-circuit proof :  
non-inherently short-circuit proof :  
non short-circuit proof : Non short-circuit proof  
fail safe  
(rated current of the cutout)
- 2.6 Rated maximum ambient temperature : ta 40 °C
- 2.7 Class : B Insulation : IEC 60 085 and IEC 60 216

### 3. Electrical values

		prim :	sec:
3.1 Rated voltage(s)	V :	230-400	24
3.2 Rated frequency	Hz :	50	
3.3 Rated current	A :	0,8-0,47	6,6
3.4 Rated output	VA :		160

## 4. Windings

- 4.1 Coil base, number : 1  
 material : Duretan AKV 30 H – PA 6.6
- 4.2 Material of layer insulation : Film poliestere 0.13 , classe B-130 - Teflex
- 4.3 Windings, number : 660+485 75  
 material : Enoflex G1 – S180 Meditherm G2 - 200
- 4.4 Diameter of wire (mm) : 0,5+0,355 1,6
- 4.5 Windings insulation, material : polyurethane polyamide polyurethane polyamide

## 5. Iron core

- 5.1 Sheet metall, material : EI 96 V530 – 50  
 main dimensions : 96x80x35
- 5.2 Cross-sectional drawing : See specification of insulation materials

## 6. Type of construction

- 6.1 Open – Covered – In case protection : Open
- 6.2 Impregnated – Undrowned – Drowned : Impregnated
- 6.3 Soaking (liquor) :
- 6.4 Underpressure – Overpressure – Soaking at : Soaking
- 6.5 Drown material : 1K – Traenharz E8561 Blaugrau Herberts

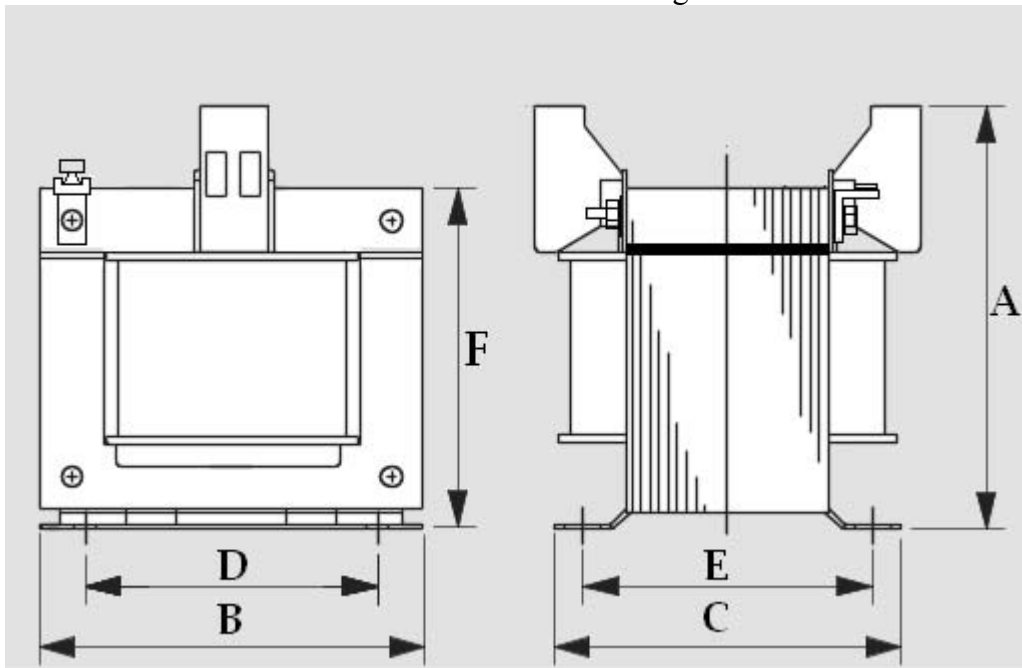

A(mm)	B(mm)	C(mm)	D(mm)	E(mm)	F(mm)	Weight (kg)
102	96	81	84	65,3	80	2,4

ELMA TT

25.08.2011