

*** Note.**

Two lengths of PC pin are available to give 12.5 or 15 mm centre to the board.

SPINDLE VARIATIONS *		BUSH VARIATIONS †		
Type	X (mm)	Y (mm)	W (mm)	Type
Plastic or Metal Fixed	4	M7 x 0.75	6	C G
Plastic or Metal Fixed	4	M7 x 0.75	6	CEP
Plastic or Metal Fixed	4	M10 x 0.75	8	CP
Plastic Fixed	6	M10 x 0.75	8	C
Plastic Fixed	6	M10 x 0.75	8	CP
Plastic Fixed	6.35	M10 x 0.75	8	C

Flatted spindles are available.

*See P16 Potentiometer 'SPINDLE DATA' leaflets for more information.

† See P16 Potentiometer 'BUSH DATA' leaflet for more information.

Mechanical and Electrical Specification - see separate leaflet.

TO ORDER see over.

This information is supplied in good faith but the customer is politely reminded that it is their responsibility to check the suitability of our products for their particular application. Please note that all dimensions are for reference purposes only and, as it is the Company's policy to continuously improve our products, we reserve the right to incorporate changes without notice.

Omeg Ltd.
 Imberhorne Industrial Estate
 East Grinstead
 West Sussex RH19 1RJ
 ENGLAND
 Tel. +44 (0) 1342 410420 Fax. +44 (0) 1342 316253
 E-mail omeg.sales@omeg.co.uk
<http://www.omeg.co.uk>

P16 MECHANICAL SPECIFICATION

- Operating Torque: 0.4 - 1.5 cN.m
- Permissible Axial Spindle Load: 50 N (5 Sec. maximum)
- Permissible Torque at End Stop: 35 cN.m
- Rotation angle, without a switch: $270^\circ \pm 5^\circ$
- Rotation angle, with a switch: $300^\circ \pm 5^\circ$
- Click Stop (indent) facility available on certain models

P16 angle of rotation - without and with a rotary switch

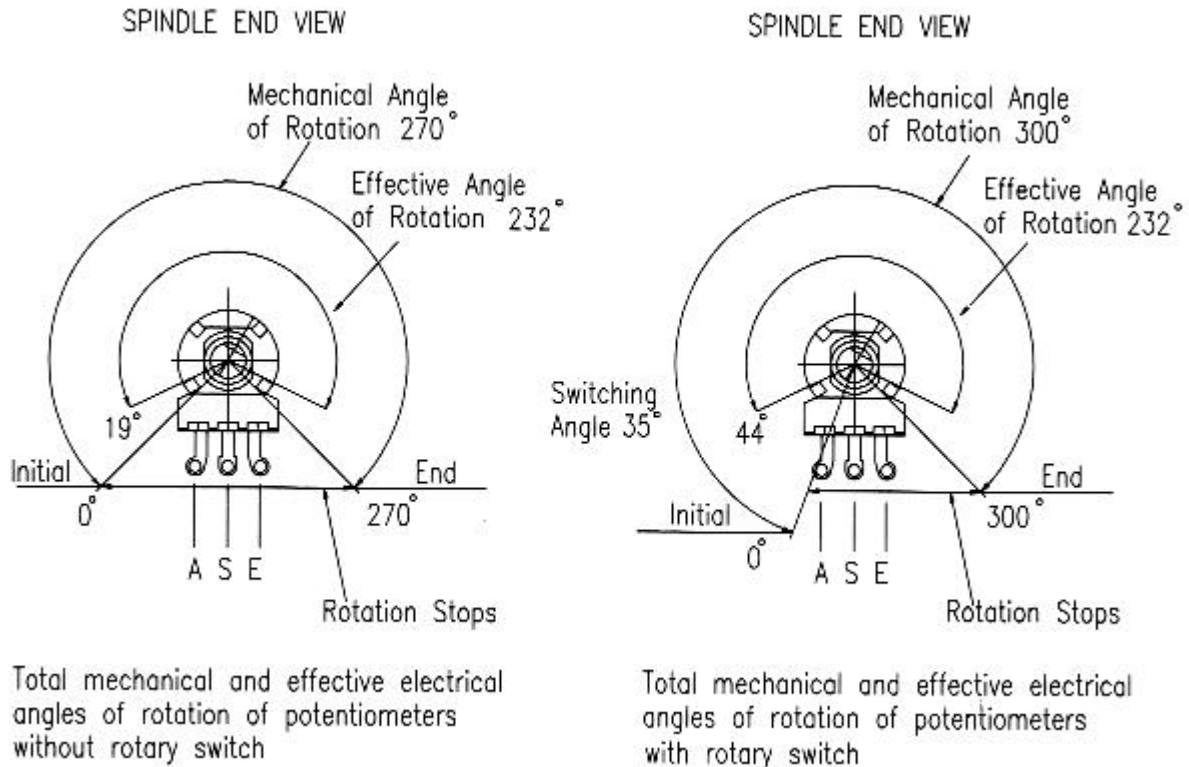

In the diagrams above **WITHOUT** switch is on the LEFT; **WITH** switch is on the RIGHT; and the potentiometer terminals are marked A, S and E.

- A = Initial termination
- S = Wiper (or moving contact) termination
- E = End termination

ELECTRICAL SPECIFICATION - UNIQUE TO P16 POTENTIOMETERS

Effective rotation:

- With or without rotary switch: 232° nominal

Rated Power Dissipation @ 40°C for P16 potentiometers:

- 0.25W linear law
- 0.12W non linear law

ECO, P16 power dissipating curve

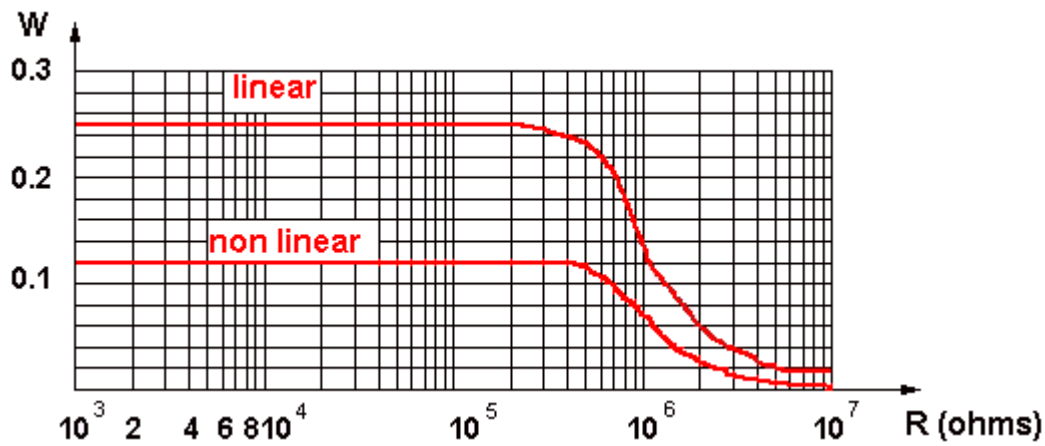

Limiting Element Voltage: 350 V DC for P16 potentiometers

ECO, P16 maximum working voltage curve

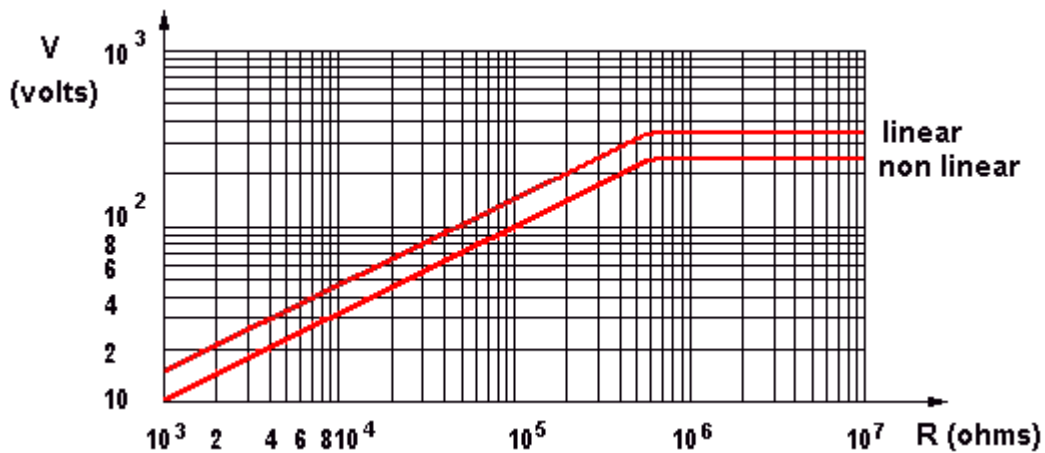

Insulating Voltage: 500 V AC for P16 potentiometers

ELECTRICAL SPECIFICATION - COMMON TO ECO, P16 AND P20 POTENTIOMETERS

Conductive polymer (plastic) track (over twice the life of carbon tracks)

Life Expectancy of >20,000 cycles (tested at 30 times per minute)

Insulation Resistance: ≥ 4 Gohms

Rated Resistance: E3 Series

- Optional: E6 Series
- Linear Law: 1K - 1M
- Non linear Law: 4K7 - 470K

Tolerance on Rated Resistance: ± 20%

- Optional Tolerance on 1K - 1M: ± 10%

Resistance Laws (Taper):

- Linear: A
- Non linear: B (Audio/Log) or C (Reverse Audio/Anti Log)
- Other laws: Please refer to Sales office

Resistance law A (Linear) curve

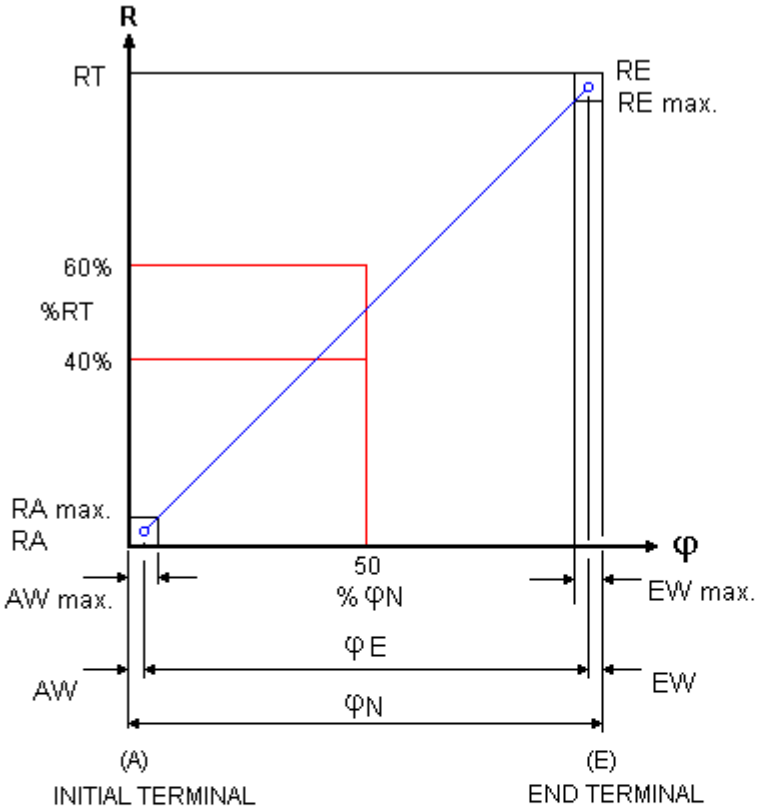

AW	Initial Path	AW max. 12% φN
EW	Final Path	EW max. 12% φN
Ra	Initial Stop Value	≤ 1. 10 ⁻³ RN (Minimum 2 ohms)
RA	Hop-on Resistance	≤ 1% RN
Re	End Stop Value	≤ 1.10 ⁻³ RN (Minimum 2 ohms)
RE	Hop-off Resistance	≤ 1% RN
RN	Rated Resistance	
RT	Effective Resistance	
φ	Rotation Angle	
φE	Effective Electrical Angle of Rotation	
φN	Effective Mechanical Angle of Rotation	

Resistance law B (Audio/Log) curve

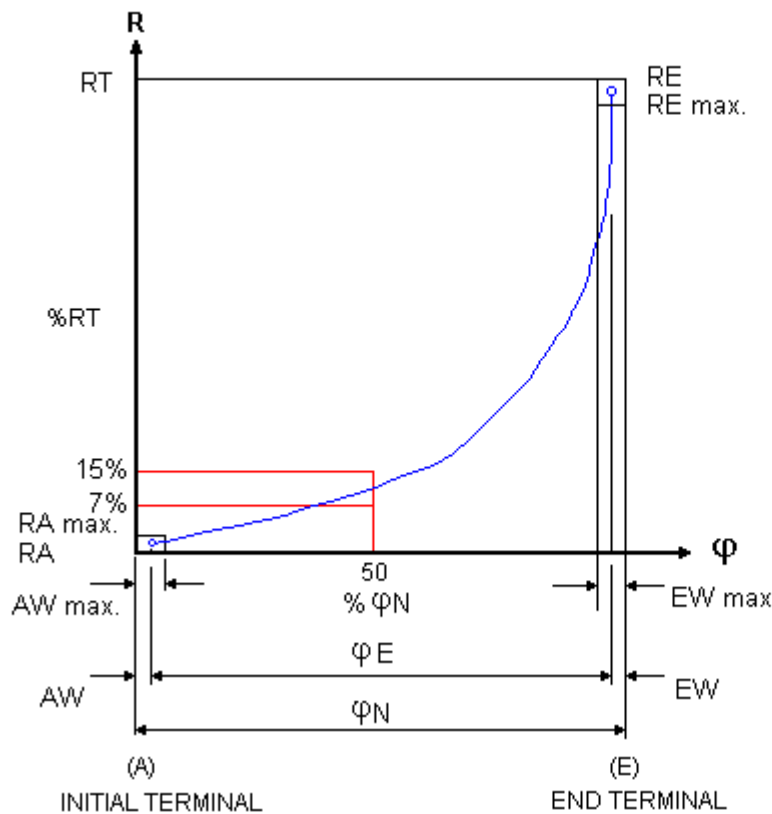

AW	Initial Path	AW max.	10% ϕ_N
EW	Final Path	EW max.	10% ϕ_N
Ra	Initial Stop Value	$R_N \leq 10K$	$\leq 1.1 \cdot 10^{-3} R_N$ (Minimum 2 ohms)
				$R_N > 10K$	$\leq 2.1 \cdot 10^{-4} R_N$ (Minimum 10 ohms)
RA	Hop-on Resistance	$R_N \leq 10K$	5% R_N
				$R_N > 10K$	0.15% R_N
Re	End Stop Value	$R_N \leq 100K$	$\leq 2.1 \cdot 10^{-2} R_N$
				$R_N > 100K$	$\leq 1.1 \cdot 10^{-2} R_N$
RE	Hop-off Resistance	$R_N \leq 10K$	$< 1\% R_N$
				$R_N > 10K$	0.5% R_N
RN	Rated Resistance			
RT	Effective Resistance			
ϕ	Rotation Angle			
ϕE	Effective Electrical Angle of Rotation			
ϕN	Effective Mechanical Angle of Rotation			

Resistance law C (Reverse Audio/Anti Log) curve

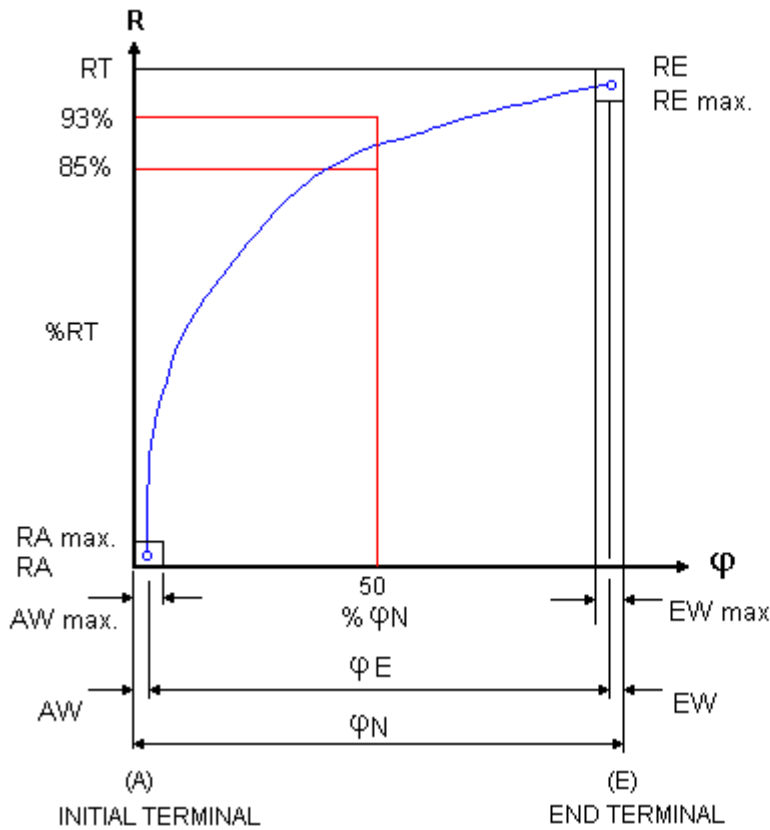

AW	Initial Path	AW max. 10% φN
EW	Final Path	EW max. 10% φN
Ra	Initial Stop Value	RN ≤ 100K ≤ 2.10 ⁻² RN RN > 100K ≤ 1.10 ⁻² RN
RA	Hop-on Resistance	RN ≤ 10K < 1% RN RN > 10K 0.5% RN
Re	End Stop Value	RN ≤ 10K ≤ 1.10 ⁻³ RN (Minimum 2 ohms) RN > 10K ≤ 2.10 ⁻⁴ RN (Minimum 10 ohms)
RE	Hop-off Resistance	RN ≤ 10K 5% RN RN > 10K 0.15% RN
RN	Rated Resistance	
RT	Effective Resistance	
φ	Rotation Angle	
φE	Effective Electrical Angle of Rotation	
φN	Effective Mechanical Angle of Rotation	

Linearity

As a basis of assessing Linearity Tolerance the independent method is the most practical, permitting as it does, the reference curve to be aligned as near as possible to the actual output curve. This avoids the use of the theoretical starting and finishing points, it is normal for the customer to realign the achieved curve with series trimmers at each end of the device if required.

Linearity Tolerance is 4% over the Nominal Resistance range of 1K0 to 1M0. The Linearity Tolerance is measured on at least 70% of the effective rotation range.

Note. In the case of Terminal and Zero-based linearity, both present constraints which increase the manufacturing difficulty and in consequence have an adverse effect on the product's price and availability.

Potentiometer linearity

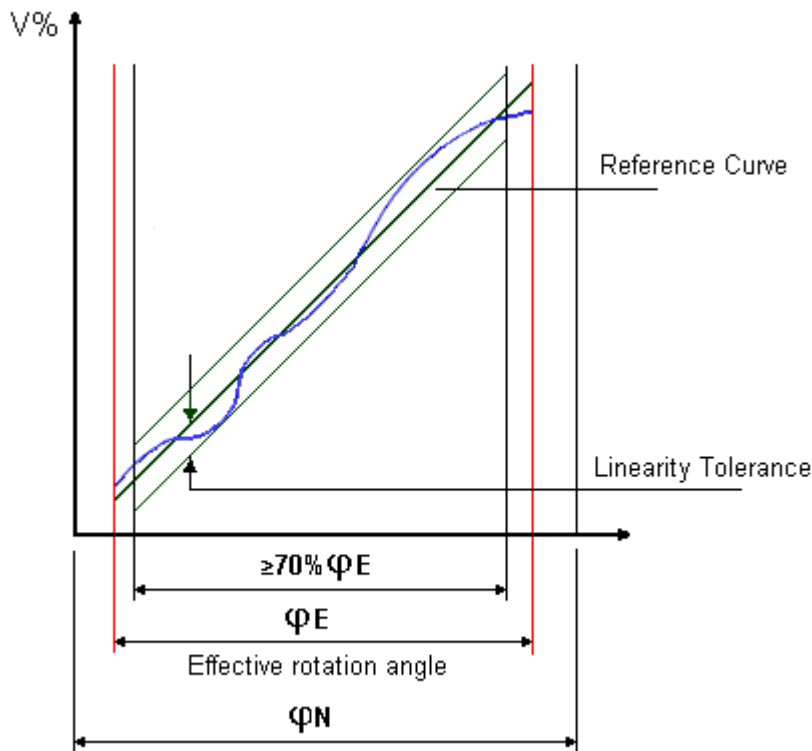

Matching Tolerance (For Tandem Stereo Potentiometers)

Tandem Potentiometers have two identical resistor units with the same variation law. The mismatching of the two resistor units, expressed in dB, is measured by the difference between the attenuations introduced by each resistor unit at various points of travel.

- Law A: 4 dB at Attenuation range 0 - 20 dB
- Law B and C: 3 dB at Attenuation range 0 - 20 dB

Matching tolerance for stereo

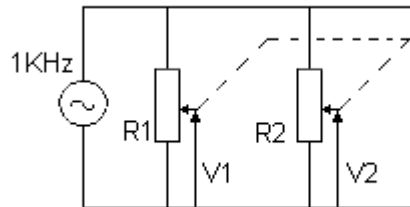

LAW	ATTENUATION RANGE	MATCHING TOLERANCE *
A	0 - 20dB	4dB
B & C	0 - 20dB	3dB

*Matching Tolerance = $20 \text{ Log } \frac{V1}{V2}$

Operating Temperature: -25°C to +70°C

Temperature derating curve

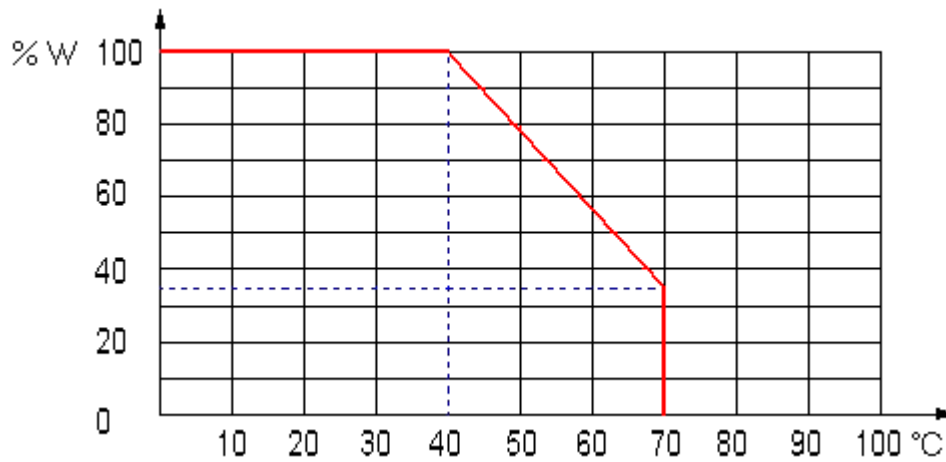

Temperature Coefficient of Resistance: +300 -500 ppm

P16 BASIC DIMENSIONS

In the diagram below the potentiometer terminals are marked A, S and E.

- A = Initial termination
- S = Wiper (or moving contact) termination
- E = End termination

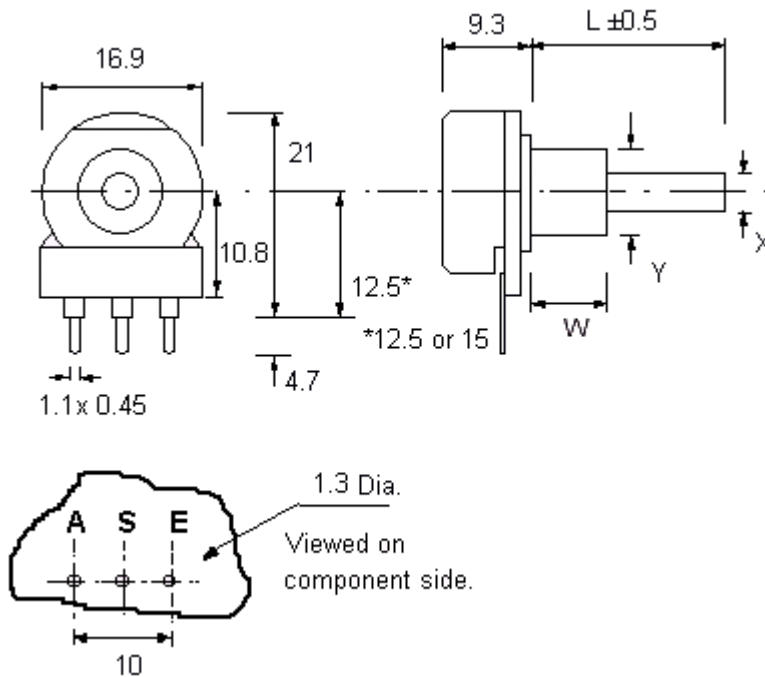

P16 BUSH OPTIONS

The P16 bushes are available in metal or nylon; with an M7 or M10 thread; and without a locating feature:

- Diecast Zinc Alloy
 - M10 x0.75mm pitch (Type C)
 - M7 x0.75mm pitch (Type CG)
- Glass Filled Nylon
 - M10 x0.75mm pitch (Type CP)

Do not attempt to prevent any unwanted body rotation by overtightening the retaining nut, since this can cause thread damage, distortion, change of electrical resistance and restrict shaft rotation. BS9130:1972 provides further details on this topic. The *recommended torque* for tightening the retaining nut is 45cN.m and this can be achieved cost effectively by using a Torque Limiting device as shown on our [Accessories](#) page.

DIECAST ZINC ALLOY

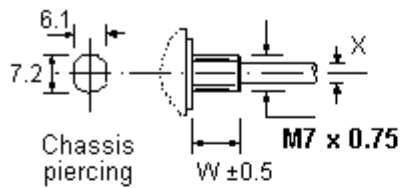

TYPE CG (without locator)	
X (mm)	4
W (mm)	6

DIECAST ZINC ALLOY

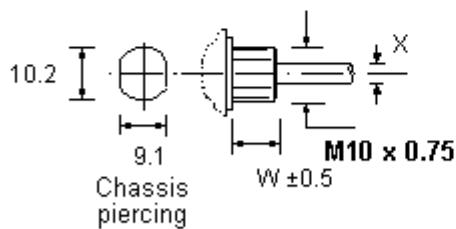

TYPE C (without locator)	
X (mm)	6 or 6.35
W (mm)	8

GLASS FILLED NYLON

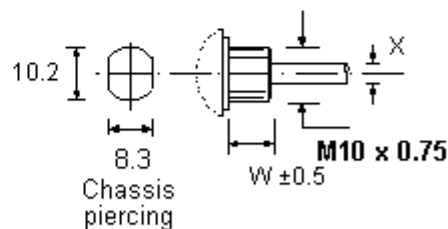

TYPE CP (GFN)	
X (mm)	4 or 6
W (mm)	8

P16 SPINDLE OPTIONS

The P16 spindles are plastic, unless otherwise stated, fixed i.e. not removable and they are available in three diameters:

- 6.0mm Diameter
 - Cylindrical (Type F1)
 - 4.0 x 12mm Flat (Type F2)
 - 5.0 x 15mm Flat (Type F3)
 - 5.0 x 10mm Flat (Type F4)
 - 4.6mm x 15mm Flat (Type F11)
- 4.0mm Diameter
 - 3.0 x 8.5mm Flat (Type F22)
 - 3.0 x 8.5mm Flat (Type M22 - Metal)
- 6.35mm Diameter
 - Cylindrical (Type F41)
 - 5.5 x 10mm Flat (Type F42)
 - 5.5 x 15mm Flat (Type F43)
- Splined Spindle - 6.0mm dia. 18 teeth
- Dual Concentric
 - Flatted/Slotted (Type M15 - Metal)
 - Cylindrical (Type M16 - Metal)

6.0mm Diameter Spindles

Note: *Specials to customer's specification up to 65mm.

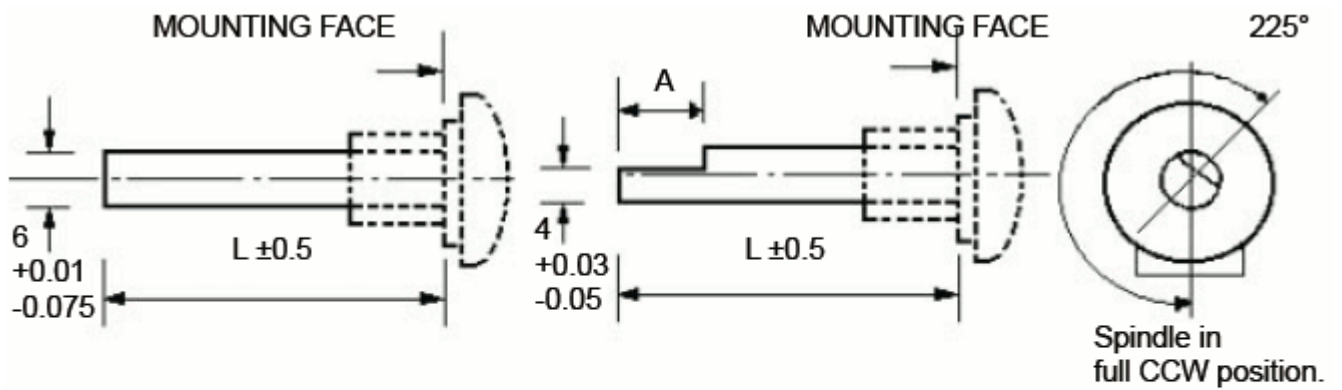

TYPE	DESC.	L (mm)
F1	Plastic Fixed	15 to 50*

TYPE	DESC.	L (mm)	A (mm)
F2	Plastic Fixed	20 to 35*	12

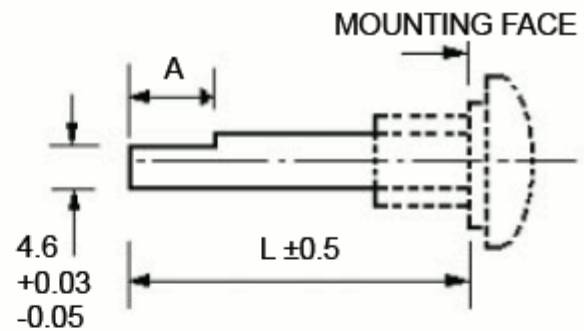
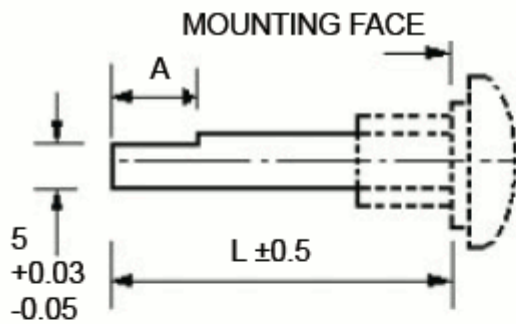

TYPE	DESC.	L (mm)	A (mm)
F3	Plastic Fixed	15 to 35*	15
F4	Plastic Fixed	15 to 35*	10

TYPE	DESC.	L (mm)	A (mm)
F11	Plastic Fixed	15 to 35*	15

4.0mm Diameter Spindles

Note: The orientation of the flat as illustrated is for plastic spindles only.
 For metal spindles, unless specified on the order, the orientation may be different on each

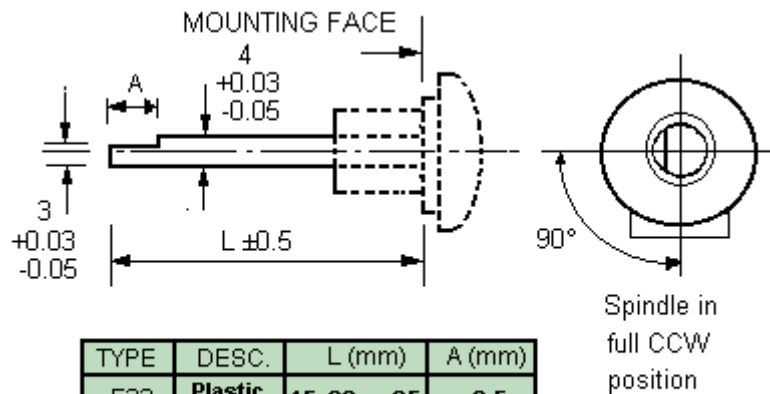

TYPE	DESC.	L (mm)	A (mm)
F22	Plastic Fixed	15, 20 or 35	8.5
M22	Metal Fixed	15	8.5

potentiometer type.

6.35mm Diameter Spindles

Note: *Specials to customer's specification up to 65mm.

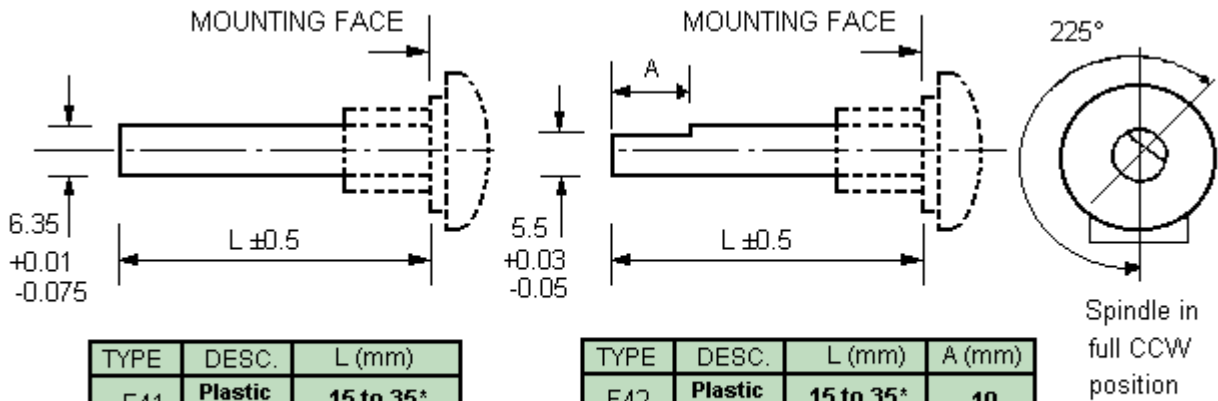

TYPE	DESC.	L (mm)
F41	Plastic Fixed	15 to 35*

TYPE	DESC.	L (mm)	A (mm)
F42	Plastic Fixed	15 to 35*	10
F43	Plastic Fixed	15 to 35*	15

Splined Spindle - 6.0mm dia. 18 teeth

A splined form is available on the 6.0mm diameter P16 plastic spindle (F5) or alternatively,

a 6mm 'Splined Adaptor' (8.7mm long) can be fitted on a 4mm dia. Spindle (F5A):

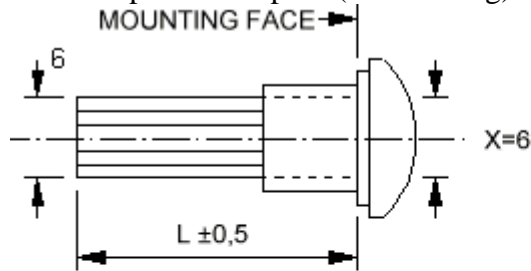

TYPE	DESC.	L (mm)
F5	Plastic Fixed	19

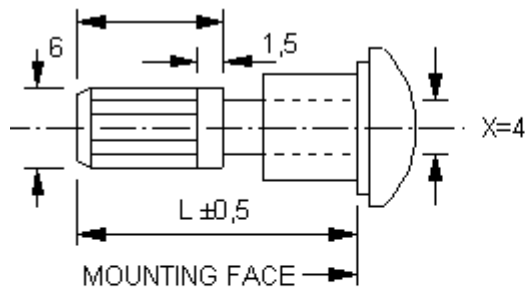
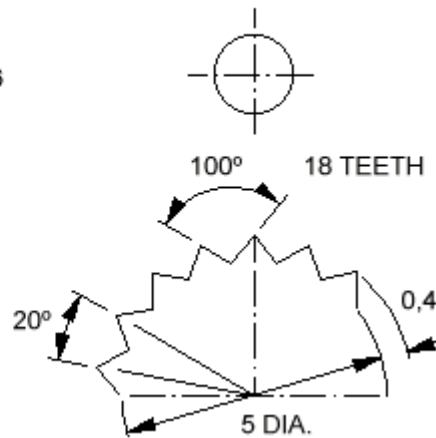

TYPE	DESC.	L (mm)
F5A	Plastic Fixed	16-36

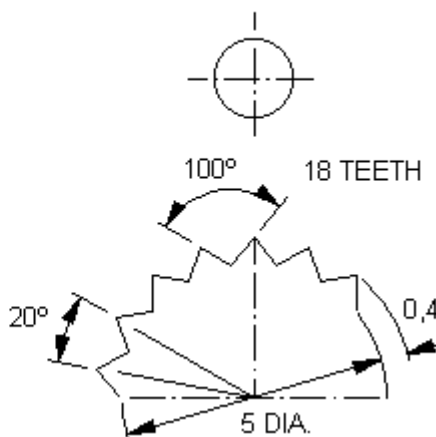

Dual Concentric Spindles

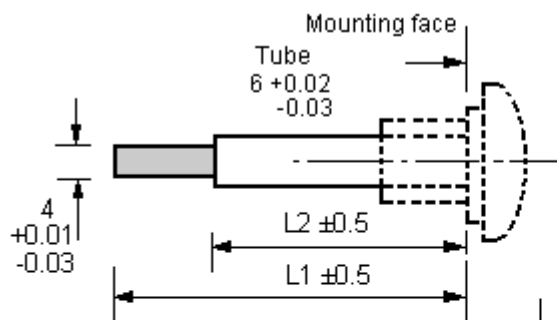

TYPE	DESC.	L1 (mm)	L2 (mm)
M15	Metal Fixed	30max. Flatted	20max. Slotted
M16	Metal Fixed	30max. No Flat	20max. No Slot

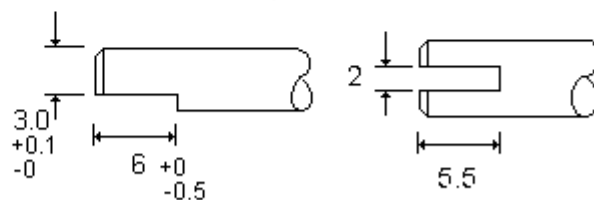
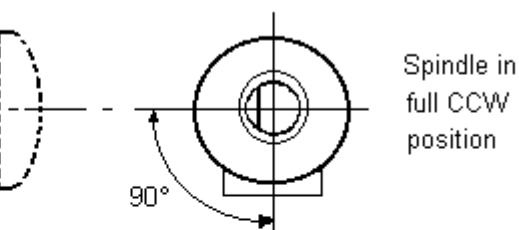

OMEG POTENTIOMETER CODING

The model type given to our potentiometers is explained on this page and covers both unswitched and switch potentiometers. Please note that not all options are available in each potentiometer range.

A unique code, or part number that specifies all the parameters of the potentiometer down to the specific spindle, is not used due to the bespoke nature of our business, please return to your previous page where you will find links to an enquiry form for your use.

The format is *POTENTIOMETER CODE (/SWITCH CODE)* where the switch code is only added if appropriate.

POTENTIOMETER CODE

The potentiometer code is in three parts:

- Prefix (Potentiometer terminals)
 - BR - Bracket (included with printed circuit terminals)
 - FN - Faston (or spade)
 - LA - Long bent and away from the spindle
 - LT - Long bent and towards the spindle
 - OW - Ordinary wiring (eyelets) - *recommended for hand soldering of wires*
 - PC - Printed circuit
 - XA - Extra long, bent away from the spindle (mainly used with switches)
- Body (Potentiometer quantity and style)
 - 2C . . - Dual (stereo) with inner and outer spindles
 - 2G . . - Dual (stereo) with one spindle
 - 3C . . - Triple (three gang) with inner and outer spindles
 - 3G . . - Triple (three gang) with one spindle
 - 4G . . - Quadruple (four gang) with one spindle
 - . . 16 - Single, 16mm size (P16) or 17mm size (ECO)
 - . . 20 - Single, 20mm size
- Suffix (Potentiometer fixing)
 - BU - Bush
 - ECO - Plastic bush housing (exclusive to the ECO potentiometer range)
 - SP - Plate without tags
 - ST - Plate with tags
 - TT - Plate with twist tabs

Note: A bracket fixing is an additional item and defined in the 'Potentiometer terminals' section above.

SWITCH CODE

The switch code is dependent on the switch body that is fitted and will be preceded with a slash (/).

ROTARY SWITCH

- Switch current rating
 - B1 - Certified and rated 1Amp
 - B4 - Certified and rated 4Amps
 - N4 - *NOT* certified and rated 4Amps
- Switch terminals
 - OW - Ordinary wiring (eyelets) - *recommended for hand soldering of wires*
 - PC - Printed circuit
- Switch contacts
 - 1S - One pole, on off (single pole, single throw SPST)
 - 1S'CH' - One pole, changeover (single pole, double throw SPDT)
 - 2S - Two poles, on off (double pole, single throw DPST)
 - 2S'CH' - Two poles, changeover (double pole, double throw SPDT)

This information is supplied in good faith but the customer is politely reminded that it is their responsibility to check the suitability of our products for their particular application, production techniques and processes. Please note that all dimensions are for reference purposes only and, as it is the Company's policy to continuously improve our products, we reserve the right to incorporate changes without notice.

Castelco™ and Omeg™ are trademarks of Omeg Limited, Registered No. 600441,
Imberhorne Industrial Estate, East Grinstead, West Sussex RH19 1RJ Tel.+44(0)1342 410420