



NTC thermistors for temperature measurement

SMD NTC thermistors,
case size 0805 (2012), standard series

Series/Type: B574**V2/ B57620C5

Date: November 2012

SMD
Applications

- Temperature measurement and compensation

Features

- Multilayer SMD NTC with inner electrodes
- Nickel barrier termination
- Excellent long-term aging stability in high temperature environment
- UL approval (E69802)

Options

- Alternative resistance ratings, resistance tolerances and B value tolerances available on request.

Delivery mode

Blister tape, 180-mm reel (standard);
330-mm reel (on request)

General technical data

Operating temperature range		T_{op}	-55 ... 125	°C
Max. power	(at 25 °C, on PCB)	$P_{25}^{(1)}$	210	mW
Resistance tolerance		$\Delta R_R / R_R$	$\pm 3, \pm 5$	%
Rated temperature		T_R	25	°C
Dissipation factor	(on PCB)	$\delta_{th}^{(1)}$	approx. 3.5	mW/K
Thermal cooling time constant	(on PCB)	$\tau_c^{(1)}$	approx. 10	s
Heat capacity		$C_{th}^{(1)}$	approx. 35	mJ/K

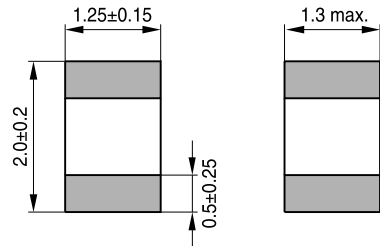
Dimensional drawing

■ Termination

TNT0473-1

Dimensions in mm

Approx. weight 13 mg

1) Depends on mounting situation

SMD
Electrical specification and ordering codes

R_{25} Ω	No. of R/T characteristic	$B_{25/50}$ K	$B_{25/85}$ K	$B_{25/100}$ K	Ordering code
1.0 k	1010	3470	3514	3530 $\pm 3\%$	B57620C5102+062
1.0 k	8502	3940	3980	4000 $\pm 3\%$	B57421V2102+062
1.5 k	8502	3940	3980	4000 $\pm 3\%$	B57421V2152+062
2.2 k	8502	3940	3980	4000 $\pm 3\%$	B57421V2222+062
3.3 k	8502	3940	3980	4000 $\pm 3\%$	B57421V2332+062
4.7 k	8500	3590	3635	3650 $\pm 3\%$	B57401V2472+062
4.7 k	8507	4386	4455	4480 $\pm 3\%$	B57471V2472+062
6.8 k	8507	4386	4455	4480 $\pm 3\%$	B57471V2682+062
10 k	1011	3660	3720	3730 $\pm 3\%$	B57620C5103+062
10 k	8500	3590	3635	3650 $\pm 3\%$	B57401V2103+062
10 k	8502	3940	3980	4000 $\pm 3\%$	B57421V2103+062
10 k	8507	4386	4455	4480 $\pm 3\%$	B57471V2103+062
15 k	8502	3940	3980	4000 $\pm 3\%$	B57421V2153+062
22 k	8502	3940	3980	4000 $\pm 3\%$	B57421V2223+062
22 k	8507	4386	4455	4480 $\pm 3\%$	B57471V2223+062
33 k	8502	3940	3980	4000 $\pm 3\%$	B57421V2333+062
33 k	8507	4386	4455	4480 $\pm 3\%$	B57471V2333+062
47 k	8502	3940	3980	4000 $\pm 3\%$	B57421V2473+062
47 k	8507	4386	4455	4480 $\pm 3\%$	B57471V2473+062
100 k	8507	4386	4455	4480 $\pm 3\%$	B57471V2104+062
470 k	8507	4386	4455	4480 $\pm 3\%$	B57471V2474+062
680 k	8507	4386	4455	4480 $\pm 3\%$	B57471V2684+062

+ = Resistance tolerance

H = $\pm 3\%$

J = $\pm 5\%$

SMD
Reliability data

SMD NTC thermistors are tested in accordance with IEC 60068. The parts are mounted on a standardized PCB in accordance with IEC 60539-1.

Test	Standard	Test conditions	$\Delta R_{25}/R_{25}$ (typical)	Remarks
Storage in dry heat	IEC 60068-2-2 JIS C 0021	Storage at upper category temperature T: (125 ±2) °C t: 1000 h	< 2% ¹⁾	
Storage in damp heat, steady state	IEC 60068-2-78 JIS C 0022	Temperature of air: (40 ±2) °C Relative humidity of air: (93 +2/−3)% Duration: 56 days ²⁾	< 2% ²⁾	
Rapid temperature cycling	IEC 60068-2-14 JIS C 0025	Lower test temperature: −55 °C Upper test temperature: 125 °C Number of cycles: 100 ³⁾	< 2% ³⁾	
Endurance		P _{max} : 210 mW T: (65 ±2) °C t: 1000 h	< 2% ⁴⁾	
Solderability	IEC 60068-2-58 JIS C 0054	Solderability: (215 ±3) °C, (3 ±0.3) s (245 ±5) °C, (3 ±0.3) s Resistance to soldering heat: (260 ±5) °C, (10 ±1) s		95% of terminations wetted
Resistance drift after soldering		Reflow soldering profile Wave soldering profile	< 1% ⁵⁾	

1) Except B57620C5102+062 $\Delta R_{25}/R_{25}$ (typical): < 6%, B57620C5103+062 $\Delta R_{25}/R_{25}$ (typical): < 3%

2) Except B57620C5102+062 and B57620C5103+062 duration: 21 days, $\Delta R_{25}/R_{25}$ (typical): < 3%

3) Except B57620C5102+062 and B57620C5103+062 number of cycles: 10, $\Delta R_{25}/R_{25}$ (typical): < 3%

4) Except B57620C5102+062 and B57620C5103+062 $\Delta R_{25}/R_{25}$ (typical): < 5%

5) Except B57620C5102+062 and B57620C5103+062 $\Delta R_{25}/R_{25}$ (typical): < 5%



SMD

R/T characteristics

R/T No.	1010		1011		8500	
T (°C)	B _{25/100} = 3530 K		B _{25/100} = 3730 K		B _{25/100} = 3650 K	
	R _T /R ₂₅	α (%/K)	R _T /R ₂₅	α (%/K)	R _T /R ₂₅	α (%/K)
-55.0	52.826	6.4	70.014	6.9	63.917	6.8
-50.0	38.643	6.1	49.906	6.7	45.889	6.5
-45.0	28.574	5.9	36.015	6.4	33.344	6.3
-40.0	21.346	5.7	26.296	6.2	24.504	6.1
-35.0	16.1	5.5	19.411	6.0	18.201	5.8
-30.0	12.256	5.4	14.479	5.8	13.657	5.6
-25.0	9.4071	5.2	10.903	5.6	10.347	5.5
-20.0	7.2862	5.0	8.2923	5.4	7.9114	5.3
-15.0	5.6835	4.9	6.3591	5.2	6.1019	5.1
-10.0	4.4698	4.7	4.9204	5.1	4.7454	4.9
-5.0	3.5385	4.6	3.8279	4.9	3.7198	4.8
0.0	2.8222	4.5	3.0029	4.8	2.938	4.6
5.0	2.2649	4.3	2.3773	4.6	2.3372	4.5
10.0	1.83	4.2	1.8959	4.5	1.8722	4.4
15.0	1.4872	4.1	1.5207	4.3	1.5096	4.2
20.0	1.2161	4.0	1.228	4.2	1.2249	4.1
25.0	1.0000	3.9	1.0000	4.1	1.0000	4.0
30.0	0.82677	3.8	0.81779	3.9	0.82111	3.9
35.0	0.68708	3.6	0.67341	3.8	0.67798	3.8
40.0	0.57401	3.5	0.55747	3.7	0.56279	3.7
45.0	0.48181	3.5	0.46357	3.6	0.46958	3.6
50.0	0.40638	3.4	0.3874	3.6	0.39374	3.5
55.0	0.34427	3.3	0.32368	3.5	0.33171	3.4
60.0	0.29296	3.2	0.272	3.4	0.28073	3.3
65.0	0.25035	3.1	0.23041	3.3	0.23863	3.2
70.0	0.21478	3.0	0.19604	3.2	0.2037	3.1
75.0	0.18501	2.9	0.16735	3.1	0.17459	3.0
80.0	0.15995	2.9	0.14342	3.0	0.15022	3.0
85.0	0.13881	2.8	0.12347	3.0	0.12975	2.9
90.0	0.12088	2.7	0.10668	2.8	0.11247	2.8
95.0	0.10563	2.7	0.092734	2.8	0.097838	2.8
100.0	0.092597	2.6	0.080903	2.8	0.085396	2.7
105.0	0.081442	2.5	0.070616	2.7	0.074781	2.6
110.0	0.071842	2.5	0.061826	2.6	0.065691	2.6
115.0	0.063571	2.4	0.054282	2.6	0.057883	2.5
120.0	0.056407	2.4	0.047793	2.5	0.051153	2.4
125.0	0.050196	2.3	0.042249	2.4	0.045335	2.4
130.0	-	-	-	-	0.040289	2.3
135.0	-	-	-	-	0.0359	2.3
140.0	-	-	-	-	0.032071	2.2
145.0	-	-	-	-	0.028723	2.2
150.0	-	-	-	-	0.025786	2.1



SMD

R/T characteristics

R/T No.	8502		8507	
T (°C)	B _{25/100} = 4000 K		B _{25/100} = 4480 K	
	R _T /R ₂₅	α (%/K)	R _T /R ₂₅	α (%/K)
-55.0	96.158	7.4	142.71	7.9
-50.0	66.892	7.1	96.913	7.6
-45.0	47.127	6.9	66.637	7.4
-40.0	33.606	6.6	46.366	7.1
-35.0	24.243	6.4	32.629	6.9
-30.0	17.681	6.2	23.213	6.7
-25.0	13.032	6.0	16.686	6.5
-20.0	9.702	5.8	12.115	6.3
-15.0	7.2923	5.6	8.8803	6.1
-10.0	5.5314	5.4	6.5692	5.9
-5.0	4.2325	5.3	4.9025	5.8
0.0	3.2657	5.1	3.6896	5.6
5.0	2.54	4.9	2.7994	5.4
10.0	1.9907	4.8	2.1406	5.3
15.0	1.5716	4.7	1.6492	5.1
20.0	1.2494	4.5	1.2798	5.0
25.0	1.0000	4.4	1.0000	4.9
30.0	0.80552	4.3	0.78663	4.7
35.0	0.65288	4.1	0.62277	4.6
40.0	0.53229	4.0	0.4961	4.5
45.0	0.43645	3.9	0.39757	4.4
50.0	0.35981	3.8	0.32044	4.3
55.0	0.29819	3.7	0.2597	4.1
60.0	0.24837	3.6	0.21161	4.0
65.0	0.20787	3.5	0.17331	3.9
70.0	0.17479	3.4	0.14265	3.8
75.0	0.14763	3.3	0.11799	3.8
80.0	0.12523	3.2	0.098035	3.7
85.0	0.10667	3.2	0.081823	3.6
90.0	0.091227	3.1	0.068589	3.5
95.0	0.078319	3.0	0.057735	3.4
100.0	0.067488	2.9	0.048796	3.3
105.0	0.058363	2.9	0.041403	3.2
110.0	0.050647	2.8	0.035263	3.2
115.0	0.044098	2.7	0.030143	3.1
120.0	0.03852	2.7	0.025858	3.0
125.0	0.033752	2.6	0.022258	3.0
130.0	0.029663	2.6	0.019223	2.9
135.0	0.026146	2.5	0.016655	2.8
140.0	0.023111	2.4	0.014476	2.8
145.0	0.020484	2.4	0.012619	2.7
150.0	0.018203	2.3	0.011033	2.7

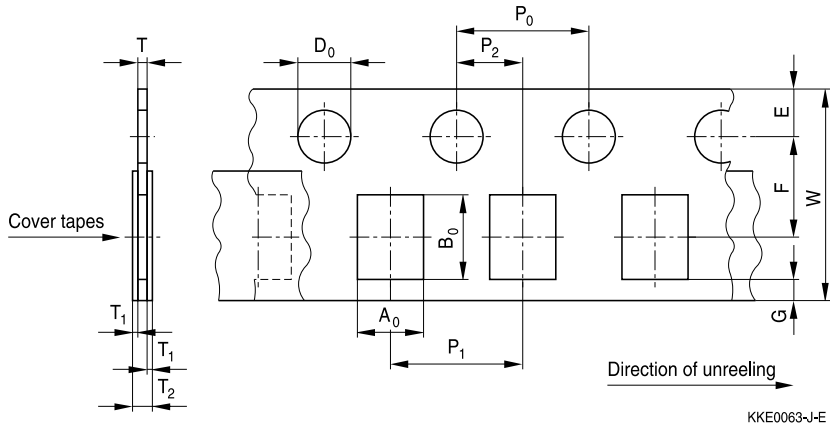
SMD
Taping and packing
1 Taping of SMD NTC thermistors
1.1 Cardboard tape for case size 0402 and 0603 (taping to IEC 60286-3)

Dimensions (mm)

	Case size 0402 (8-mm tape)	Case size 0603 (8-mm tape)	Tolerance
$A_0 \times B_0$	0.60 × 1.15	0.95 × 1.80	±0.2
T_2	0.70	1.10	
T	0.60	0.90	max.
D_0	1.50	1.50	±0.10
P_0	4.00	4.00	±0.10 ¹⁾
P_2	2.00	2.00	±0.05
P_1	2.00	4.00	±0.10
W	8.00	8.00	±0.30
E	1.75	1.75	±0.10
F	3.50	3.50	±0.05
G	0.75	0.75	min.

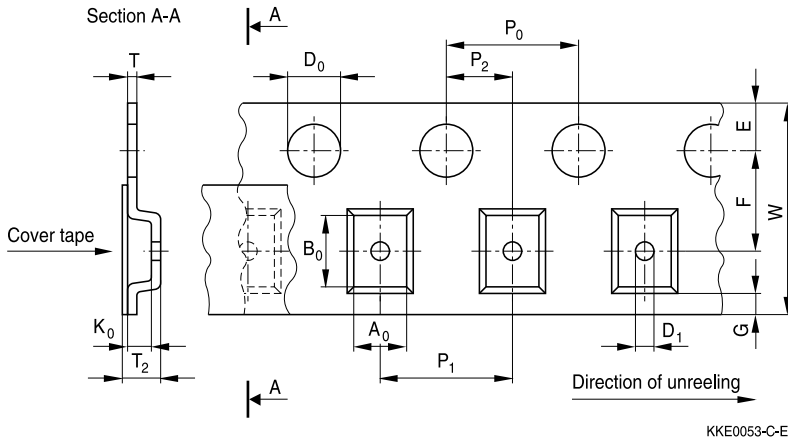
1) ≤0.2 mm over 10 sprocket holes.

SMD
1.2 Blister tape for case size 0805 and 1206 (taping to IEC 60286-3)

KKE0053-C-E

Dimensions (mm)

	Case size 0805 (8-mm tape)	Case size 1206 (8-mm tape)	Tolerance
$A_0 \times B_0$	1.60 × 2.40	1.90 × 3.50	±0.2
K_0	1.40	1.40	max.
T_2	2.5	2.5	max.
D_0	1.50	1.50	+0.10/-0
D_1	1.00	1.00	min.
P_0	4.00	4.00	±0.10 ²⁾
P_2	2.00	2.00	±0.05
P_1	4.00	4.00	±0.10
W	8.00	8.00	±0.30
E	1.75	1.75	±0.10
F	3.50	3.50	±0.05
G	0.75	0.75	min.

2) ≤0.2 mm over 10 sprocket holes.

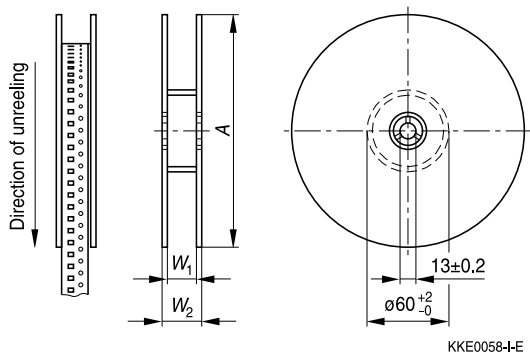
SMD
1.3 Reel packing

Packing survey

Case size	Chip thickness ³⁾ mm	8-mm tape		Reel dimensions mm					Packing units	
		Blister	Card-board	A	Tol.	W1	Tol.	W2	180-mm reel	330-mm reel
0402	0.5		x	180	-3/+0	8.4	+1.5/-0	14.4 max.	10000	-
0603	0.8		x	180	-3/+0	8.4	+1.5/-0	14.4 max.	4000	-
				330	±2.0	12.4	+1.5/-0	18.4 max.	-	16000
0805	0.8	x		180	-3/+0	8.4	+1.5/-0	14.4 max.	4000	16000
	1.2	x		330	±2.0	12.4	+1.5/-0	18.4 max.	3000	12000
1206	0.8	x		180	-2/+0	8.4	+1.5/-0	14.4 max.	4000	-
	1.2	x		180	-2/+0	8.4	+1.5/-0	14.4 max.	2000	-

3) Chip thickness depends on the resistance value.

SMD

2 Packing codes

The last two digits of the complete ordering code state the packing mode:

Last two digits			
60	SMD	Cardboard tape	180-mm reel packing
62	SMD	Blister tape	180-mm reel packing
70	SMD	Cardboard tape	330-mm reel packing
72	SMD	Blister tape	330-mm reel packing

SMD
Mounting instructions
1 Soldering
1.1 SMD NTC thermistors

SMD NTC thermistors can be provided with a nickel barrier termination or on special request with silver-palladium termination. The usage of mild, non-activated fluxes for soldering is recommended as well as a proper cleaning of the PCB.

The nickel barrier layer of the silver/nickel/tin termination (see figure 1) prevents leaching of the silver base metalization layer. This allows great flexibility in the selection of soldering parameters.

The tin prevents the nickel layer from oxidizing and thus ensures better wetting by the solder. The nickel barrier termination is suitable for all commonly-used soldering methods.

Note: SMD NTCs with AgPd termination are not approved for lead-free soldering.

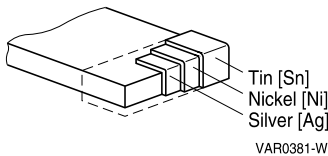

Figure 1

SMD NTC thermistors, structure of nickel barrier termination

1.1.1 Solderability (test to IEC 60068-2-58)

Preconditioning: Immersion into flux F-SW 32.

Evaluation criterion: Wetting of soldering areas $\geq 95\%$.

Solder	Bath temperature (°C)	Dwell time (s)
SnPb 60/40	215 \pm 3	3 \pm 0.3
SnAg (3.0 ... 4.0), Cu (0.5 ... 0.9)	245 \pm 3	3 \pm 0.3

1.1.2 Resistance to soldering heat (test to IEC 60068-2-58)

Preconditioning: Immersion into flux F-SW 32.

Evaluation criterion: Leaching of side edges $\leq 1/3$.

Solder	Bath temperature (°C)	Dwell time (s)
SnPb 60/40	260 \pm 5	10 \pm 1
SnAg (3.0 ... 4.0), Cu (0.5 ... 0.9)	260 \pm 5	10 \pm 1

SMD

Wave soldering

Temperature characteristic at component terminal with dual wave soldering

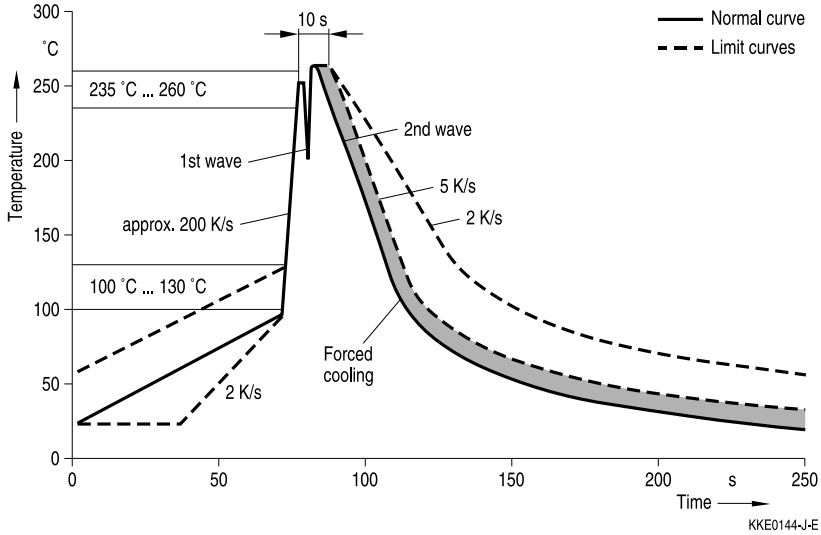

Solder joint profiles for silver/nickel/tin terminations

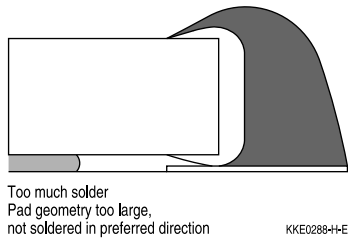
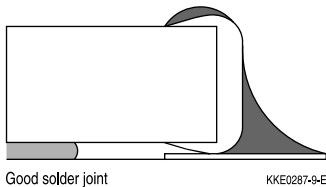

SMD
Reflow soldering

Recommended temperature characteristic for reflow soldering following JEDEC J-STD-020D

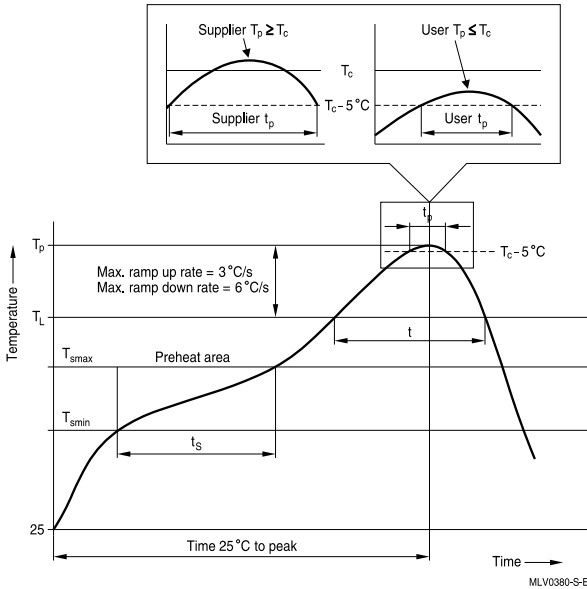

Profile feature		Sn-Pb eutectic assembly	Pb-free assembly
Preheat and soak			
- Temperature min	T_{smin}	100 °C	150 °C
- Temperature max	T_{smax}	150 °C	200 °C
- Time	t_{smin} to t_{smax}	60 ... 120 s	60 ... 180 s
Average ramp-up rate	T_{smax} to T_p	3 °C/ s max.	3 °C/ s max.
Liquidous temperature	T_L	183 °C	217 °C
Time at liquidous	t_L	60 ... 150 s	60 ... 150 s
Peak package body temperature	T_p ¹⁾	220 °C ... 235 °C ²⁾	245 °C ... 260 °C ²⁾
Time (t_p) ³⁾ within 5 °C of specified classification temperature (T_c)		20 s ³⁾	30 s ³⁾
Average ramp-down rate	T_p to T_{smax}	6 °C/ s max.	6 °C/ s max.
Time 25 °C to peak temperature		maximum 6 min	maximum 8 min

 1) Tolerance for peak profile temperature (T_p) is defined as a supplier minimum and a user maximum.

2) Depending on package thickness. For details please refer to JEDEC J-STD-020D.

 3) Tolerance for time at peak profile temperature (t_p) is defined as a supplier minimum and a user maximum.

Note: All temperatures refer to topside of the package, measured on the package body surface.

Number of reflow cycles: 3

SMD

Solder joint profiles for silver/nickel/tin terminations

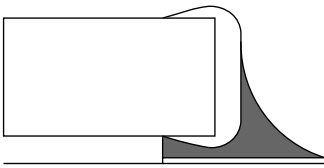

Good solder joint

TNT0565-G-E

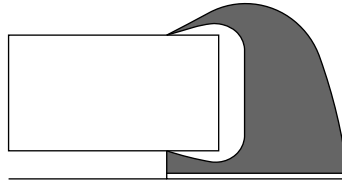

Too much solder
Pad geometry too large

KKE0071-A-E

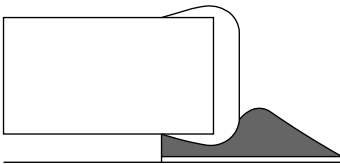

Poor wetting

KKE0072-I-E

1.1.3 Recommended geometry of solder pads

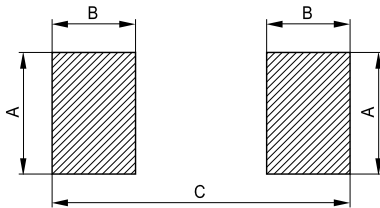

KKE0092-X

Recommended maximum dimensions (mm)

Case size inch/mm	A	B	C
0402/1005	0.6	0.6	1.7
0603/1608	1.0	1.0	3.0
0805/2012	1.3	1.2	3.4
1206/3216	1.8	1.2	4.5

1.1.4 Notes

Iron soldering should be avoided, hot air methods are recommended for repair purposes.

SMD

2 Conductive adhesion

An alternative to soldering is the gluing of thermistors with conductive adhesives. The benefit of this method is that it involves no thermal stress. The adhesives used must be chemically inert.

3 Clamp contacting

Pressure contacting by means of clamps is particularly suitable for applications involving frequent switching and high turn-on powers.

4 Sealing and potting

When thermistors are sealed, potted or overmolded, there must be no mechanical stress caused by thermal expansion during the production process (curing / overmolding process) and during later operation. The upper category temperature of the thermistor must not be exceeded. Ensure that the materials used (sealing / potting compound and plastic material) are chemically neutral.

5 Cleaning

If cleaning is necessary, mild cleaning agents such as ethyl alcohol and cleaning gasoline are recommended. Cleaning agents based on water are not allowed. Ultrasonic cleaning methods are permissible.

6 Storage

In order to maintain their solderability, thermistors must be stored in a non-corrosive atmosphere. Humidity, temperature and container materials are critical factors.

Do not store SMDs where they are exposed to heat or direct sunlight. Otherwise, the packing material may be deformed or SMDs may stick together, causing problems during mounting. After opening the factory seals, such as polyvinyl-sealed packages, use the SMDs as soon as possible.

The components should be left in the original packing. Touching the metallization of unsoldered thermistors may change their soldering properties.

Storage temperature: $-25\text{ }^{\circ}\text{C}$ up to $45\text{ }^{\circ}\text{C}$

Relative humidity (without condensation): $\leq 75\%$ annual mean

$< 95\%$, maximum 30 days per annum

Solder the thermistors listed in this data book after shipment from EPCOS within the time specified:

SMDs: 12 months for Ni-barrier termination
6 months for AgPd termination

SMD

7 Placement and orientation of SMD NTC thermistors on PCB

a) Component placement

Incorrect

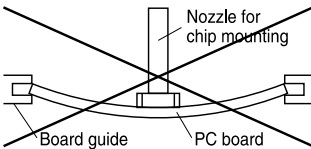

Correct

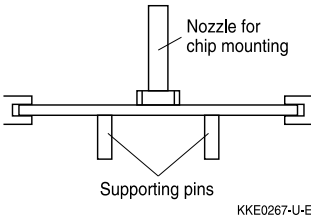

It is recommended that the PC board should be held by means of some adequate supporting pins such as shown left to prevent the SMDs from being damaged or cracked.

b) Cracks

SMDs located near an easily warped area

SMD breakage probability due to stress at a breakaway

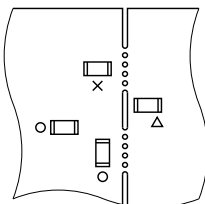
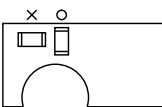

O = correct
X = incorrect
Δ = incorrect (under certain conditions)

KKE0268-3-E

When placing a component near an area which is apt to bend or a grid groove on the PC board, it is advisable to have both electrodes subjected to uniform stress, or to position the component's electrodes at right angles to the grid groove or bending line (see c) Component orientation).

c) Component orientation

Locate chip horizontal to the direction in which stress acts

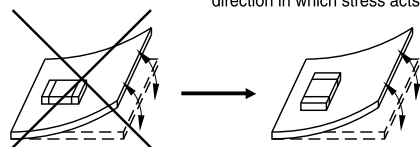

Incorrect orientation

Correct orientation

KKE0269-B-E

Choose a mounting position that minimizes the stress imposed on the chip during flexing or bending of the board.

SMD

Cautions and warnings

General

See "Important notes".

Storage

- Store thermistors only in original packaging. Do not open the package prior to storage.
- Storage conditions in original packaging: storage temperature $-25\text{ °C} \dots +45\text{ °C}$, relative humidity $\leq 75\%$ annual mean, $< 95\%$ maximum 30 days per annum, dew precipitation is inadmissible.
- Do not store thermistors where they are exposed to heat or direct sunlight. Otherwise, the packing material may be deformed or components may stick together, causing problems during mounting.
- Avoid contamination of thermistor surface during storage, handling and processing.
- Avoid storage of thermistors in harmful environments like corrosive gases (SO_x , Cl etc).
- Use the components as soon as possible after opening the factory seals, i.e. the polyvinyl-sealed packages.
- Solder SMD NTC thermistors with nickel barrier termination within 12 months after shipment from EPCOS.

Handling

- NTC thermistors must not be dropped. Chip-offs or any other damage must not be caused during handling of NTCs.
- Do not touch components with bare hands. Gloves are recommended.
- Avoid contamination of thermistor surface during handling.
- Washing processes may damage the product due to the possible static or cyclic mechanical loads (e.g. ultrasonic cleaning). They may cause cracks to develop on the product and its parts, which might lead to reduced reliability or lifetime.

Soldering

- Use resin-type flux or non-activated flux.
- Insufficient preheating may cause ceramic cracks.
- Rapid cooling by dipping in solvent is not recommended.
- Complete removal of flux is recommended.

SMD

Mounting

- Ensure that no thermo-mechanical stress occurs due to production processes (curing or overmolding processes) when thermistors are sealed, potted or overmolded or during their subsequent operation. The maximum temperature of the thermistor must not be exceeded. Ensure that the materials used (sealing/potting compound and plastic material) are chemically neutral.
- Electrodes/contacts must not be scratched or damaged before/during/after the mounting process.
- Contacts and housing used for assembly with the thermistor must be clean before mounting.
- Ensure that adjacent materials are designed for operation at temperatures comparable to the surface temperature of the thermistor. Be sure that surrounding parts and materials can withstand the temperature.
- Avoid contamination of the thermistor surface during processing.
- The connections of sensors (e.g. cable end, wire end, plug terminal) may only be exposed to an environment with normal atmospheric conditions.
- Avoid using chemical substances as mounting aids. It must be ensured that no water or other liquids enter the NTC thermistors (e.g. through plug terminals). In particular, water based substances (e.g. soap suds) must not be used as mounting aids for sensors.

Operation

- Use thermistors only within the specified operating temperature range.
- Use thermistors only within the specified power range.
- Environmental conditions must not harm the thermistors. Only use the thermistors under normal atmospheric conditions or within the specified conditions.
- Contact of NTC thermistors with any liquids and solvents should be prevented. It must be ensured that no water enters the NTC thermistors (e.g. through plug terminals). For measurement purposes (checking the specified resistance vs. temperature), the component must not be immersed in water but in suitable liquids (e.g. Galden).
- Avoid dewing and condensation unless thermistor is specified for these conditions.
- Be sure to provide an appropriate fail-safe function to prevent secondary product damage caused by malfunction.

This listing does not claim to be complete, but merely reflects the experience of EPCOS AG.

SMD
Symbols and terms

Symbol	English	German
A	Area	Fläche
B	B value	B-Wert
B _{25/100}	B value determined by resistance measurement at 25 °C and 100 °C	B-Wert, ermittelt durch Widerstandsmessungen bei 25 °C und 100 °C
C _{th}	Heat capacitance	Wärmekapazität
I	Current	Strom
N	Number (integer)	Anzahl (ganzzahliger Wert)
P ₂₅	Maximum power at 25 °C	Maximale Leistung bei 25 °C
P _{diss}	Power dissipation	Verlustleistung
P _{el}	Electrical power	Elektrische Leistung
P _{max}	Maximum power within stated temperature range	Maximale Leistung im angegebenen Temperaturbereich
$\Delta R_B/R_B$	Resistance tolerance caused by spread of B value	Widerstandstoleranz, die durch die Streuung des B-Wertes verursacht wird
R _{ins}	Insulation resistance	Isolationswiderstand
R _p	Parallel resistance	Parallelwiderstand
R _R	Rated resistance	Nennwiderstand
$\Delta R_R/R_R$	Resistance tolerance	Widerstandstoleranz
R _S	Series resistance	Serienwiderstand
R _T	Resistance at temperature T (e.g. R ₂₅ = resistance at 25 °C)	Widerstand bei Temperatur T (z.B. R ₂₅ = Widerstand bei 25 °C)
T	Temperature	Temperatur
ΔT	Temperature tolerance	Temperaturtoleranz
t	Time	Zeit
T _A	Ambient temperature	Umgebungstemperatur
T _{max}	Upper category temperature	Obere Grenztemperatur (Kategorietemperatur)
T _{min}	Lower category temperature	Untere Grenztemperatur (Kategorietemperatur)
T _{op}	Operating temperature	Betriebstemperatur
T _R	Rated temperature	Nenntemperatur
T _{surf}	Surface temperature	Oberflächentemperatur
V	Voltage	Spannung
V _{ins}	Insulation test voltage	Isolationsprüfspannung
V _{op}	Operating voltage	Betriebsspannung
V _{test}	Test voltage	Prüfspannung

SMD

Symbol	English	German
α	Temperature coefficient	Temperaturkoeffizient
Δ	Tolerance, change	Toleranz, Änderung
δ_{th}	Dissipation factor	Wärmeleitwert
τ_c	Thermal cooling time constant	Thermische Abkühlzeitkonstante
τ_a	Thermal time constant	Thermische Zeitkonstante

Abbreviations / Notes

Symbol	English	German
<u>SMD</u>	Surface-mounted devices	Oberflächenmontierbares Bauelement
*	To be replaced by a number in ordering codes, type designations etc.	Platzhalter für Zahl im Bestellnummerncode oder für die Typenbezeichnung.
+	To be replaced by a letter. All dimensions are given in mm. The commas used in numerical values denote decimal points.	Platzhalter für einen Buchstaben. Alle Maße sind in mm angegeben. Verwendete Kommas in Zahlenwerten bezeichnen Dezimalpunkte.

Important notes

The following applies to all products named in this publication:

1. Some parts of this publication contain **statements about the suitability of our products for certain areas of application**. These statements are based on our knowledge of typical requirements that are often placed on our products in the areas of application concerned. We nevertheless expressly point out **that such statements cannot be regarded as binding statements about the suitability of our products for a particular customer application**. As a rule, EPCOS is either unfamiliar with individual customer applications or less familiar with them than the customers themselves. For these reasons, it is always ultimately incumbent on the customer to check and decide whether an EPCOS product with the properties described in the product specification is suitable for use in a particular customer application.
2. We also point out that **in individual cases, a malfunction of electronic components or failure before the end of their usual service life cannot be completely ruled out in the current state of the art, even if they are operated as specified**. In customer applications requiring a very high level of operational safety and especially in customer applications in which the malfunction or failure of an electronic component could endanger human life or health (e.g. in accident prevention or lifesaving systems), it must therefore be ensured by means of suitable design of the customer application or other action taken by the customer (e.g. installation of protective circuitry or redundancy) that no injury or damage is sustained by third parties in the event of malfunction or failure of an electronic component.
3. **The warnings, cautions and product-specific notes must be observed.**
4. In order to satisfy certain technical requirements, **some of the products described in this publication may contain substances subject to restrictions in certain jurisdictions (e.g. because they are classed as hazardous)**. Useful information on this will be found in our Material Data Sheets on the Internet (www.epcos.com/material). Should you have any more detailed questions, please contact our sales offices.
5. We constantly strive to improve our products. Consequently, **the products described in this publication may change from time to time**. The same is true of the corresponding product specifications. Please check therefore to what extent product descriptions and specifications contained in this publication are still applicable before or when you place an order. We also **reserve the right to discontinue production and delivery of products**. Consequently, we cannot guarantee that all products named in this publication will always be available. The aforementioned does not apply in the case of individual agreements deviating from the foregoing for customer-specific products.
6. Unless otherwise agreed in individual contracts, **all orders are subject to the current version of the "General Terms of Delivery for Products and Services in the Electrical Industry" published by the German Electrical and Electronics Industry Association (ZVEI)**.
7. The trade names EPCOS, BAOKE, Alu-X, CeraDiode, CeraLink, CSMP, CSSP, CTVS, DeltaCap, DigiSiMic, DSSP, FilterCap, FormFit, MiniBlue, MiniCell, MKD, MKK, MLSC, MotorCap, PCC, PhaseCap, PhaseCube, PhaseMod, PhiCap, SIFERRIT, SIFI, SIKOREL, SilverCap, SIMDAD, SiMic, SIMID, SineFormer, SIOV, SIP5D, SIP5K, ThermoFuse, WindCap are **trademarks registered or pending** in Europe and in other countries. Further information will be found on the Internet at www.epcos.com/trademarks.