

1/2" (12.7 mm) Conductive Plastic and Cermet Potentiometer

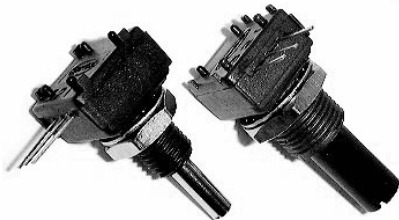

FEATURES

- Model 248: 0.5 W at 70 °C (conductive plastic element)
- Model 249: 1 W at 70 °C (cermet element)
- Cost effective panel potentiometer
- PCB mounting
- Tests according to CECC 41000 or IEC 60393-1
- Compliant to RoHS Directive 2002/95/EC



RoHS
COMPLIANT

DIMENSIONS in millimeters (inches) ± 0.5 mm (± 0.02")

X = Standards leads

METAL OR PLASTIC SHAFTS

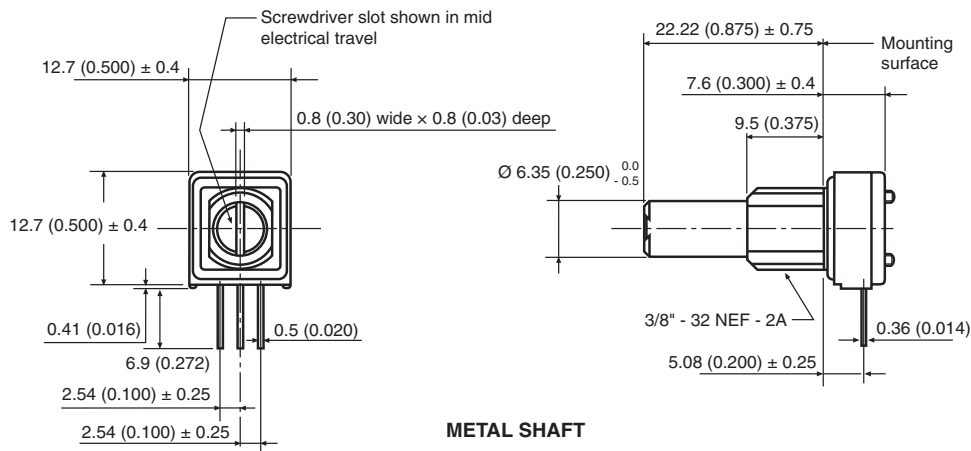

METAL SHAFT

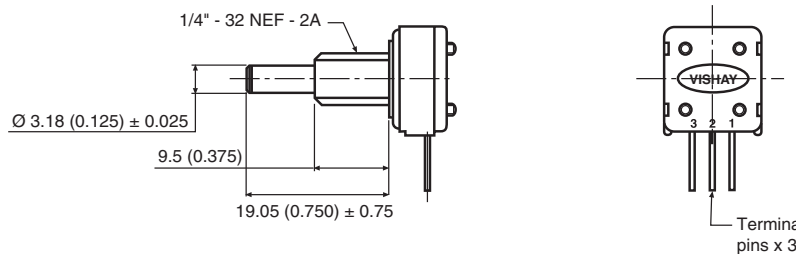

E = Rear stand off

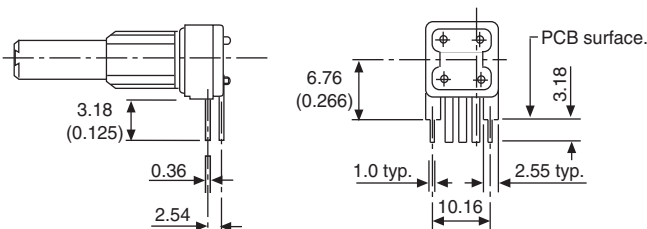

D = Rear locating lugs

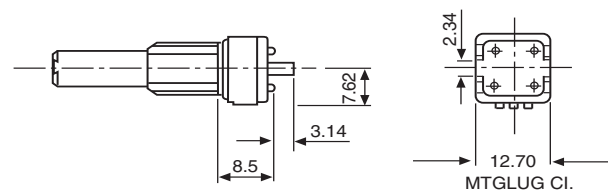

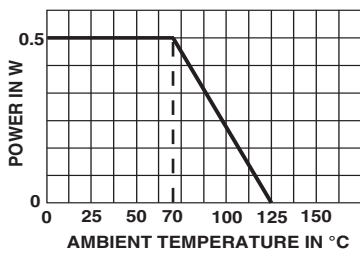
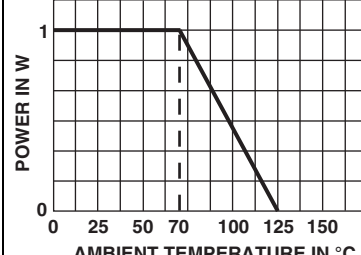
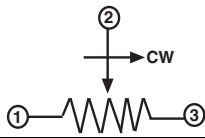
ELECTRICAL SPECIFICATIONS		
PARAMETER	MODEL 248	MODEL 249
Element Type	Conductive plastic	Cermet
Total Resistance Range	500 Ω to 1 M Ω	
Standard Series	1, 2, 5	
Resistance Tolerance	$\pm 20\%$	$\pm 20\%$ (on request $\pm 10\%$)
Power Rating	0.5 W at 70 $^{\circ}\text{C}$	1.0 W at 70 $^{\circ}\text{C}$
		
Circuit Diagram		
Temperature Coefficient of Resistance (Typical)	± 1000 ppm/ $^{\circ}\text{C}$	± 150 ppm/ $^{\circ}\text{C}$
Linearity (Typical)	$\pm 5\%$ independent	
Limiting Element Voltage	300 V	
Contact Resistance Variation	5 % of the total resistance	
Insulation Resistance	1000 M Ω minimum, 500 V _{DC}	
Dielectric Strength	750 V _{RMS} minimum 50 Hz/60 Hz	
End Resistance	2 Ω maximum each end	
Effective Electrical Travel	265 $^{\circ}$ $\pm 5^{\circ}$	

MECHANICAL SPECIFICATIONS		
Mechanical Travel		295 $^{\circ}$ $\pm 5^{\circ}$
Operating Torque		0.1 Ncm to 2 Ncm
End Stop Torque		35 Ncm (50 oz.-inch)
Max. Tightening Torque	1/4" Bush	50 Ncm
	3/8" Bush	70 Ncm
Weight		8.3 g (0.29 oz.) (1/4" x 7/8" FMF metal shaft)

ENVIRONMENTAL SPECIFICATIONS	
Temperature Range	- 55 $^{\circ}\text{C}$ to 125 $^{\circ}\text{C}$
Climatic Category	55/125/4
Sealing	IP50

MARKING

- Vishay trademark
- Part number
- Tolerance
- Date code
- Terminal identification

PACKAGING

- In box of 50 pieces, code B25 (BO50)

PERFORMANCE

TESTS	CONDITIONS	TYPICAL VALUES AND DRIFTS FOR 249		
		$\Delta R_T/R_T$ (%)	$\Delta R_{1-2}/R_{1-2}$ (%)	OTHER
Electrical Endurance	1000 h at rated power 90°/30° - ambient temp. 70 °C	± 3 %	± 5 %	Contact res. variation: < 1 %
Damp Heat, Steady State	4 days 40 °C 93 % HR	± 2 %	-	Dielectric strength: 1000 V _{RMS} Insulation resistance: > 10 ⁴ MΩ
Change of Temperature	5 cycles - 55 °C at + 125 °C	± 1 %	-	$\Delta V_{1-2}/V_{1-3} \leq \pm 2 \%$
Mechanical Endurance	10 000 cycles	± 3 %	-	Contact res. variation: ≤ 2 % Rn
Shock	50 g's at 11 ms 3 successive shocks in 3 directions	± 1 %	± 2 %	-
Vibration	10 Hz to 55 Hz 0.75 mm or 10 g's during 6 h	± 1 %	-	$\Delta V_{1-2}/V_{1-3} \leq \pm 2 \%$

STANDARD RESISTANCE ELEMENT DATA

STANDARD RESISTANCE VALUES	248 LINEAR TAPER			249 LINEAR TAPER		
	MAX. POWER AT 70 °C	MAX. WORKING VOLTAGE	MAX. WIPER CURRENT	MAX. POWER AT 70 °C	MAX. WORKING VOLTAGE	MAX. WIPER CURRENT
Ω	W	V	mA	W	V	mA
500	0.5	15.8	32	1	22.4	45
1K	0.5	22.4	22	1	31.6	32
2K	0.5	31.6	16	1	44.7	22
2.5K	0.5	35.4	14	1	50.0	20
5K	0.5	50.0	10	1	70.7	14
10K	0.5	70.7	7	1	100	10
20K	0.5	100	5.0	1	141	7
25K	0.5	112	4.5	1	158	6
50K	0.5	158	3.2	1	224	4
100K	0.5	224	2.2	0.90	300	3.0
200K	0.45	300	1.50	0.45	300	1.5
250K	0.36	300	1.20	0.36	300	1.2
500K	0.18	300	0.60	0.18	300	0.6
1M	0.09	300	0.30	0.09	300	0.3



1/2" (12.7 mm) Conductive Plastic and Cermet
Potentiometer

ORDERING INFORMATION (Part Number)																																	
2		4		8		F		G		J		S		P		X		B		2		5		2		5		2		M		A	
MODEL	BUSHING	SHAFT				SHAFT END	SHAFT MATERIAL	LEADS	PACKAGING	RESISTANCE CODE/TOLERANCE/TAPER OR SPECIAL																							
248 = Plastic conductive 249 = Cermet element	F = Ø 3/8" B = Ø 1/4"		Ø	L	Old codes	S = Slotted R = Round F = Flatted D = Custom	0 = Metal (old codes 8 and 9) P = Plastic (old code 7)	D E X = Std	B25 = Box 50 pieces	Resistance: From 501 = 500 Ω to 105 = 1 MΩ Tolerance: M = 20 %; On request : K = 10 % (249 only) Taper: A = Linear; L = Logarithmic (old code J) or special code given by Vishay																							
		GJ	1/4"	7/8"	7 and 9																												
		BH	1/8"	3/4"	8																												
		AP	Custom shaft																														

PART NUMBER DESCRIPTION (for information only)												
248	F	GJ	S	P	X	B050	2K5	20 %	A			e3
MODEL	BUSHING	SHAFT	SHAFT END	SHAFT MATERIAL	LEADS	PACKAGING	VALUE	TOLERANCE	TAPER	SPECIAL	SPECIAL	LEAD FINISH



Disclaimer

ALL PRODUCT, PRODUCT SPECIFICATIONS AND DATA ARE SUBJECT TO CHANGE WITHOUT NOTICE TO IMPROVE RELIABILITY, FUNCTION OR DESIGN OR OTHERWISE.

Vishay Intertechnology, Inc., its affiliates, agents, and employees, and all persons acting on its or their behalf (collectively, "Vishay"), disclaim any and all liability for any errors, inaccuracies or incompleteness contained in any datasheet or in any other disclosure relating to any product.

Vishay makes no warranty, representation or guarantee regarding the suitability of the products for any particular purpose or the continuing production of any product. To the maximum extent permitted by applicable law, Vishay disclaims (i) any and all liability arising out of the application or use of any product, (ii) any and all liability, including without limitation special, consequential or incidental damages, and (iii) any and all implied warranties, including warranties of fitness for particular purpose, non-infringement and merchantability.

Statements regarding the suitability of products for certain types of applications are based on Vishay's knowledge of typical requirements that are often placed on Vishay products in generic applications. Such statements are not binding statements about the suitability of products for a particular application. It is the customer's responsibility to validate that a particular product with the properties described in the product specification is suitable for use in a particular application. Parameters provided in datasheets and/or specifications may vary in different applications and performance may vary over time. All operating parameters, including typical parameters, must be validated for each customer application by the customer's technical experts. Product specifications do not expand or otherwise modify Vishay's terms and conditions of purchase, including but not limited to the warranty expressed therein.

Except as expressly indicated in writing, Vishay products are not designed for use in medical, life-saving, or life-sustaining applications or for any other application in which the failure of the Vishay product could result in personal injury or death. Customers using or selling Vishay products not expressly indicated for use in such applications do so at their own risk and agree to fully indemnify and hold Vishay and its distributors harmless from and against any and all claims, liabilities, expenses and damages arising or resulting in connection with such use or sale, including attorneys fees, even if such claim alleges that Vishay or its distributor was negligent regarding the design or manufacture of the part. Please contact authorized Vishay personnel to obtain written terms and conditions regarding products designed for such applications.

No license, express or implied, by estoppel or otherwise, to any intellectual property rights is granted by this document or by any conduct of Vishay. Product names and markings noted herein may be trademarks of their respective owners.

Material Category Policy

Vishay Intertechnology, Inc. hereby certifies that all its products that are identified as RoHS-Compliant fulfill the definitions and restrictions defined under Directive 2011/65/EU of The European Parliament and of the Council of June 8, 2011 on the restriction of the use of certain hazardous substances in electrical and electronic equipment (EEE) - recast, unless otherwise specified as non-compliant.

Please note that some Vishay documentation may still make reference to RoHS Directive 2002/95/EC. We confirm that all the products identified as being compliant to Directive 2002/95/EC conform to Directive 2011/65/EU.