

Features

5 A modular SSR, 1 NO output

- 17.5 mm housing
- AC output (with back to back SCR)
- 5 kV (1.2/50 μ s) insulation between Input and Output
- Zero-crossing and random switch-on versions available
- High switching speed
- High endurance
- Silent switching
- Spark and bounce-free switching
- Low control power
- 35 mm rail (EN 60715) mount

77.01
Screw terminal



* see L77-3 diagram page 8
** see L77-1 and L77-2 diagrams page 7

For outline drawing see page 10

Output specification

Output configuration	1 NO (SPST-NO)
Rated current / Max. peak current (10 ms *) A	5 / 300 *
Rated switching voltage V AC (50/60 Hz)	60...240
Switching voltage range V AC (50/60 Hz)	48...265
Blocking (max. reverse repetitive) voltage V DC	800
Rated load AC7a (cos φ = 0.8) A	5
Rated load AC15 A	5
Single phase motor rating (230 V AC) kW	—
230 V lamps rating:	
incandescent W	1,000
compact fluorescent (CFL) W	800
electronic ballast fluorescent tubes W	1,000
electromagnetic ballast compensated fluorescent tubes W	500
Minimum switching current @ 230 V mA	100
Typical "OFF-state" leakage current @ 230 V mA	1
Max "ON-state" voltage drop @ 25 °C and 5A/100mA V	0.85 / 1.5

Input specification

Nominal voltage (U_N)	V AC (50/60 Hz)	24	110 ... 240	24	110 ... 240
	V DC	12 ... 24	—	12 ... 24	—
Rated power	VA (50 Hz)/W	0.6 / 0.5	3.6 / 0.3	0.6 / 0.5	3.6 / 0.3
Operating range	V AC (50/60 Hz)	16...32	90...265	16...32	90...265
	V DC	9.8...32	—	9.8...32	—
Must drop-out voltage	V AC (50/60 Hz)/DC	2.4	24	2.4	24

Technical data

Electrical life	cycles	10·10 ⁶	10·10 ⁶
Operate / release time	ms	20 / 12	9 / 8
Insulation between input and output (1.2/50 μ s)	kV	5	5
Ambient temperature	°C	-20...+70 **	-20...+70 **
Protection category		IP20	IP20

Approvals (according to type)

77.01.x.xxx.8050



Zero-crossing switch-on

Suggested applications:

- Lamp inrush current reduction (CFL - Compact Fluorescent energy-saving Lamps and similar)
- Heater control
- Solenoid, contactor driver

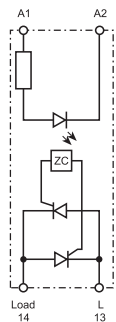

Simplified circuit diagram

77.01.x.xxx.8051



Random switch-on

Suggested applications:

- Fine controls involving shorter time (specially motor control)
- AC supply phase different from AC output phase
- 3-phase general purpose

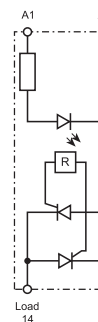

Simplified circuit diagram

Features

15 A modular SSR, 1 NO output

- 22.5 mm housing, heat-sink + plastic cover
- AC output (with triac)
- 6 kV (1.2/50 μs) insulation between Input and Output
- Zero-crossing and random switch-on versions available
- High switching speed
- High endurance
- Silent switching
- Spark and bounce-free switching
- Low control power
- "Relay-style" terminal arrangement (input and output terminals on opposite sides)
- 35 mm rail (EN 60715) mount

77.11
Screw terminal



* see L77-7 diagram page 8
** see L77-6 diagrams page 7

For outline drawing see page 10

NEW 77.11.x.xxx.8250



Zero-crossing switch-on

Suggested applications:

- Lamp inrush current reduction (CFL - Compact Fluorescent energy-saving Lamps and similar)
- Heater control
- Solenoid, contactor driver

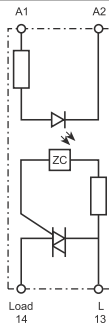

Simplified circuit diagram

NEW 77.11.x.xxx.8251



Random switch-on

Suggested applications:

- Fine controls involving shorter time (specially motor control)

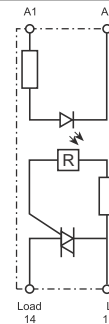

Simplified circuit diagram

Output specification					
Output configuration		1 NO (SPST-NO)		1 NO (SPST-NO)	
Rated current / Max. peak current (10 ms *) A		15 / 400 *		15 / 400 *	
Rated switching voltage V AC (50/60 Hz)		24 / 280		24 / 280	
Switching voltage range V AC (50/60 Hz)		19 / 305		19 / 305	
Blocking (max. reverse repetitive) voltage V DC		800		800	
Rated load AC7a (cos φ = 0.8, @ 25 °C) A		20		20	
Rated load AC15 A		15		15	
Single phase motor rating (230 V AC) kW		—		1.2	
230 V lamps rating:					
incandescent W		4,000		2,500	
compact fluorescent (CFL) W		3,000		1,500	
electronic ballast fluorescent tubes W		4,000		2,500	
electromagnetic ballast compensated fluorescent tubes W		2,000		1,000	
Minimum switching current @ 250 V mA		100		100	
Typical "OFF-state" leakage current@ 250 V mA		1		1	
Max "ON-state" voltage drop @25 °C and 15 A V		1.55		1.55	
Power loss @ 15 A W		14		14	
Input specification					
Nominal voltage (U _N)					
V AC (50/60 Hz)		—		230	
V DC		24		—	
Rated power @ U _{MAX}					
VA (50 Hz)/W		0.4		7.5 / 0.9	
Operating range					
V AC (50/60 Hz)		—		40...305	
V DC		4...32		—	
Must drop-out voltage V AC (50/60 Hz)/DC		— / 2		6 / —	
Technical data					
Electrical life					
cycles		10·10 ⁶		10·10 ⁶	
Operate / release time					
ms		< 10 / <10		< 10 / < 30	
Insulation between input and output (1.2/50μs) kV		6		6	
Ambient temperature		—20...+80 **		—20...+80 **	
Protection category		IP20		IP20	
Approvals (according to type)		CE			

Features

30 A modular SSR, 1 NO output

- 22.5 mm housing, heat-sink + plastic cover
- AC output (with back to back SCR)
- 6 kV (1.2/50 μs) insulation between Input and Output
- Zero-crossing and random switch-on versions available
- High switching speed
- High endurance
- Silent switching
- Spark and bounce-free switching
- Low control power
- "Relay-style" terminal arrangement (input and output terminals on opposite sides)
- 35 mm rail (EN 60715) mount

77.31
Screw terminal



* see L77-5 diagram page 8
** see L77-4 diagrams page 7

For outline drawing see page 10

Output specification

Output configuration	1 NO (SPST-NO)		1 NO (SPST-NO)	
Rated current / Max. peak current (10 ms *) A	30 / 520 *		30 / 520 *	
Rated switching voltage V AC (50/60 Hz)	60...440		60...440	
Switching voltage range V AC (50/60 Hz)	48...480		48...480	
Blocking (max. reverse repetitive) voltage V DC	1,100		1,100	
Rated load AC7a (cos φ = 0.8) A	30		30	
Rated load AC15 A	20		20	
Single phase motor rating (230 V AC) kW	—		2.5	
230 V lamps rating:				
incandescent W	6,000		4,500	
compact fluorescent (CFL) W	4,000		2,500	
electronic ballast fluorescent tubes W	6,000		4,000	
electromagnetic ballast compensated fluorescent tubes W	3,000		1,800	
Minimum switching current @ 400 V mA	300		300	
Typical "OFF-state" leakage current@ 400 V mA	1		1	
Max "ON-state" voltage drop @25 °C and 30 A V	0.85		0.85	
Power loss @ 30 A W	16		16	

Input specification

Nominal voltage (U _N)	V AC (50/60 Hz)	—	230	—	230
	V DC	24	—	24	—
Rated power @ U _{MAX}	VA (50 Hz)/W	0.4	7.5 / 0.9	0.4	7.5 / 0.9
Operating range	V AC (50/60 Hz)	—	40...280	—	40...280
	V DC	4...32	—	4...32	—
Must drop-out voltage	V AC (50/60 Hz)/DC	— / 2	6 / —	— / 2	6 / —

Technical data

Electrical life	cycles	10·10 ⁶		10·10 ⁶	
Operate / release time	ms	< 10 / <10	< 10 / < 30	< 1 / <10	< 2 / < 25
Insulation between input and output (1.2/50μs)	kV	6		6	
Ambient temperature	°C	-20...+80 **		-20...+80 **	
Protection category		IP20		IP20	

Approvals (according to type)



77.31.x.xxx.8050



Zero-crossing switch-on

Suggested applications:

- Lamp inrush current reduction (CFL - Compact Fluorescent energy-saving Lamps and similar)
- Heater control
- Solenoid, contactor driver

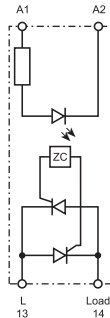

Simplified circuit diagram

77.31.x.xxx.8051



Random switch-on

Suggested applications:

- Fine controls involving shorter time (specially motor control)

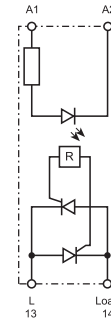

Simplified circuit diagram

Features

30 A modular SSR, 1 NO output

- 22.5 mm housing, heat-sink + plastic cover
- AC output (with back to back SCR)
- 6 kV (1.2/50 µs) insulation between Input and Output
- Zero-crossing and random switch-on versions available
- High switching speed
- High endurance
- Silent switching
- Spark and bounce-free switching
- Low control power
- "Contactor-style" terminal arrangement (input and output terminals on adjacent sides)
- 35 mm rail (EN 60715) mount

77.31
Screw terminal



* see L77-5 diagram page 8
** see L77-4 diagrams page 7

For outline drawing see page 10

77.31.x.xxx.8070



Zero-crossing switch-on

Suggested applications:

- Lamp inrush current reduction (CFL - Compact Fluorescent energy-saving Lamps and similar)
- Heater control
- Solenoid, contactor driver

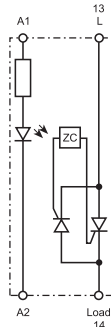

Simplified circuit diagram

77.31.x.xxx.8071



Random switch-on

Suggested applications:

- Fine controls involving shorter time (specially motor control)

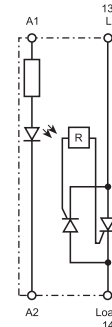

Simplified circuit diagram

Output specification					
Output configuration		1 NO (SPST-NO)		1 NO (SPST-NO)	
Rated current / Max. peak current (10 ms *) A		30 / 520 *		30 / 520 *	
Rated switching voltage V AC (50/60 Hz)		60...440		60...440	
Switching voltage range V AC (50/60 Hz)		48...480		48...480	
Blocking (max. reverse repetitive) voltage V DC		1,100		1,100	
Rated load AC7a (cos φ = 0.8) A		30		30	
Rated load AC15 A		20		20	
Single phase motor rating (230 V AC) kW		—		2.5	
230 V lamps rating:					
incandescent W		6,000		4,500	
compact fluorescent (CFL) W		4,000		2,500	
electronic ballast fluorescent tubes W		6,000		4,000	
electromagnetic ballast compensated fluorescent tubes W		3,000		1,800	
Minimum switching current @ 400 V mA		300		300	
Typical "OFF-state" leakage current@ 400 V mA		1		1	
Max "ON-state" voltage drop @25 °C and 30 A V		0.85		0.85	
Power loss @ 30 A W		16		16	
Input specification					
Nominal voltage (U _N)					
V AC (50/60 Hz)		—		230	
V DC		24		—	
Rated power @ U _{MAX}					
VA (50 Hz)/W		0.4		7.5 / 0.9	
Operating range					
V AC (50/60 Hz)		—		40...280	
V DC		4...32		—	
Must drop-out voltage V AC (50/60 Hz)/DC		— / 2		6 / —	
Technical data					
Electrical life		cycles		10·10 ⁶	
Operate / release time		ms		< 10 / <10	
Insulation between input and output (1.2/50µs) kV				6	
Ambient temperature		°C		-20...+80 **	
Protection category				IP20	
Approvals (according to type)				CE	

Ordering information

Example: 77 series modular SSR, 1 output 30 A AC, input voltage 230 V AC, relay style terminals arrangement, zero-crossing switch-on.

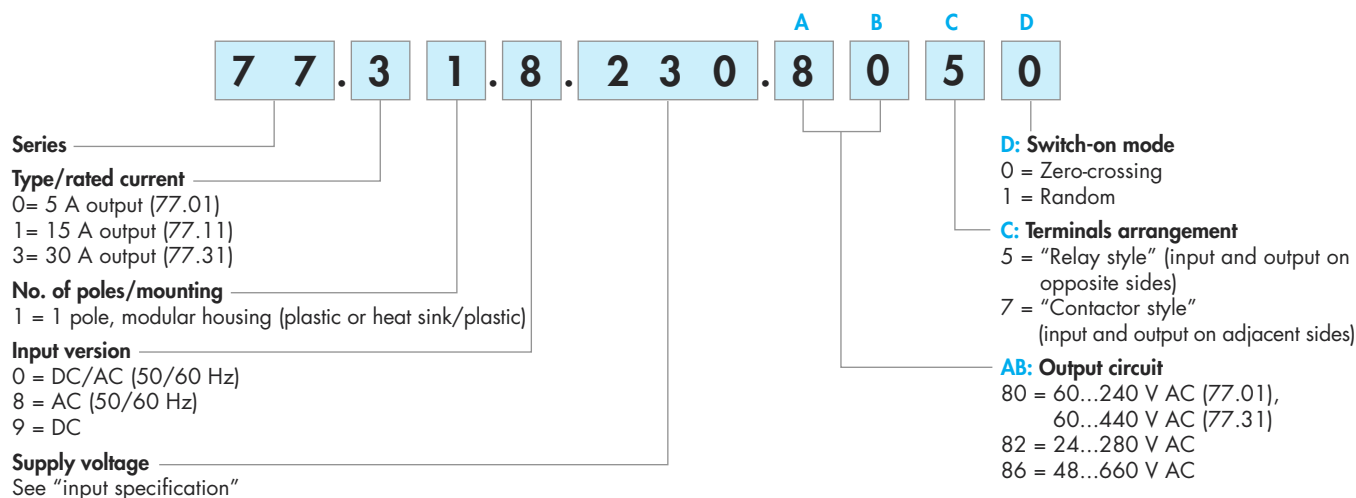

Codes / Module width

77.01.8.230.8050 / 17.5 mm 5 A	77.11.8.230.8250 / 22.5 mm 15 A	77.31.8.230.8050 / 22.5 mm 30 A
77.01.0.024.8050 / 17.5 mm 5 A	77.11.9.024.8250 / 22.5 mm 15 A	77.31.9.024.8050 / 22.5 mm 30 A
77.01.8.230.8051 / 17.5 mm 5 A	77.11.8.230.8251 / 22.5 mm 15 A	77.31.8.230.8051 / 22.5 mm 30 A
77.01.0.024.8051 / 17.5 mm 5 A	77.11.9.024.8251 / 22.5 mm 15 A	77.31.9.024.8051 / 22.5 mm 30 A
		77.31.8.230.8070 / 22.5 mm 30 A
		77.31.9.024.8070 / 22.5 mm 30 A
		77.31.8.230.8071 / 22.5 mm 30 A
		77.31.9.024.8071 / 22.5 mm 30 A

Technical data

Insulation		77.01		77.31		77.11		
		Dielectric strength	Impulse (1.2/50 µs)	Dielectric strength	Impulse (1.2/50 µs)	Dielectric strength	Impulse (1.2/50 µs)	
Between input and output		2,500 V AC	5 kV	3,000 V AC	6 kV	3,000 V AC	6 kV	
Between input and ground (heat-sink)		—	—	3,000 V AC	6 kV	3,000 V AC	6 kV	
Between output and ground (heat-sink)		—	—	4,000 V AC	6 kV	2,500 V AC	4 kV	
EMC specifications		Reference standard	77.01		77.31		77.11	
			24 V AC/DC	230 V AC	24 V DC	230 V AC	24 V DC	230 V AC
Electrostatic discharge	contact discharge	EN 61000-4-2	4 kV		4 kV		4 kV	
	air discharge	EN 61000-4-2	8 kV		8 kV		8 kV	
Radiated electromagnetic field (80 ... 1,000 MHz)		EN 61000-4-3	30 V/m		30 V/m		20 V/m	
Fast transients on supply terminals (burst 5/50 ns, 5 and 100 kHz)		EN 61000-4-4	1 kV	4 kV	1 kV	3 kV	1 kV	3 kV
Voltage pulses on supply terminals (surge 1.2/50 µs)	common mode	EN 61000-4-5	2 kV	4 kV	3 kV	3 kV	3 kV	3 kV
	differential mode	EN 61000-4-5	1 kV	4 kV	0.5 kV	1.5 kV	0.5 kV	1.5 kV
Radio-frequency common mode voltage (0.15...230 MHz) on supply terminals		EN 61000-4-6	—		10 V		10 V	
Terminals			77.01		77.31		77.11	
Screw torque		Nm	0.8		0.8		0.8	
Max. wire size			solid cable	stranded cable	solid cable	stranded cable	solid cable	stranded cable
		mm ²	1x6/2x4	1x4/2x2.5	1x6/2x4	1x6 / 2x4	1x6/2x4	1x6 / 2x4
		AWG	1x10/2x12	1x12/2x14	1x10/2x12	1x10/2x12	1x10/2x12	1x10/2x12
Wire strip length		mm	9		9		9	
Other data			77.01		77.31		77.11	
Power lost to the environment	without output current	W	0.5		0.9		0.9	
	with rated current	W	4.0		16		14	

Input specification

77.01

Nominal voltage	Input code	Operating range				Must drop-out voltage (AC/DC)	Input current I_N at U_N
		AC		DC			
		U_{min}	U_{max}	U_{min}	U_{max}		
U_N V		V	V	V	V	V	mA
24	0.024	16	32	9.8	32	2.4	25
230	8.230	90	265	—	—	24	15

77.11

Nominal voltage	Input code	Operating range				Must drop-out voltage (AC/DC)	Input current I_N at U_N
		AC		DC			
		U_{min}	U_{max}	U_{min}	U_{max}		
U_N V		V	V	V	V	V	mA
24	9.024	—	—	4	32	2	11
230	8.230	40	305	—	—	6	25

77.31

Nominal voltage	Input code	Operating range				Must drop-out voltage (AC/DC)	Input current I_N at U_N
		AC		DC			
		U_{min}	U_{max}	U_{min}	U_{max}		
U_N V		V	V	V	V	V	mA
24	9.024	—	—	4	32	2	11
230	8.230	40	280	—	—	6	25

Led indication

LED	Supply voltage
	OFF
	ON

Output specification

L77-1 Output RMS current vs. ambient temperature
77.01.0.024.805x @ 32 V DC

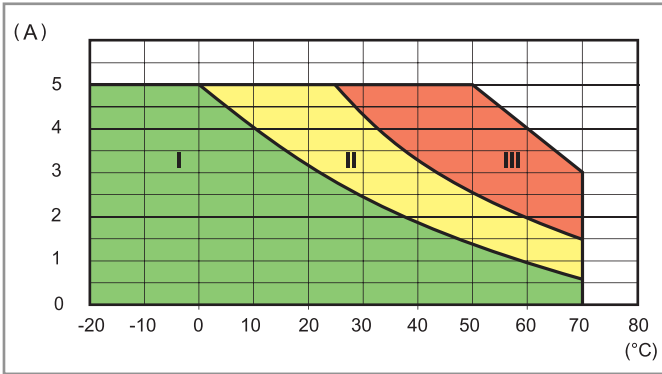

- I - Modular SSR installed as a group (without gap)
- II - Modular SSR installed as a group (9 mm gap between each SSR)
- III - Modular SSR installed individually in free air (without a significant influence from nearby components)

L77-2 Output RMS current vs. ambient temperature
77.01.8.230.805x @ 265 V AC

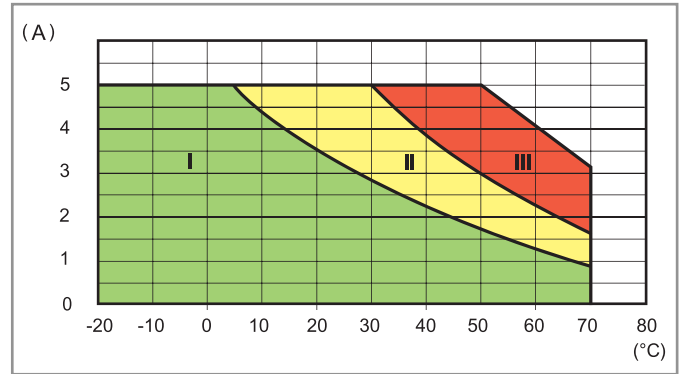

L77-4 Output RMS current vs. ambient temperature
77.31.x.xxx.80xx

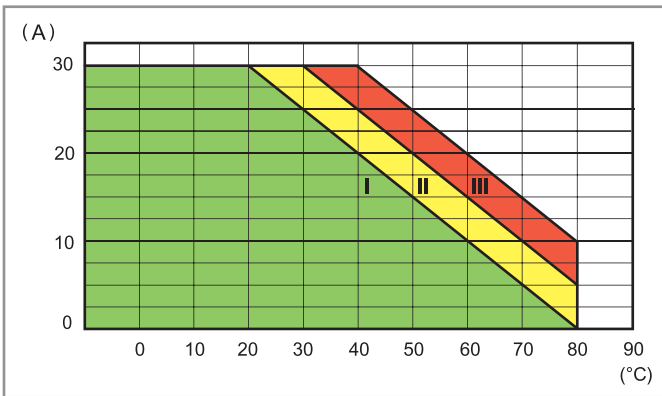

- I - Modular SSR installed as a group (without gap)
- II - Modular SSR installed as a group (20 mm gap between each SSR)
- III - Modular SSR installed individually in free air , or with a gap ≥ 40 mm, which implies a not significant influence from nearby components

L77-6 Output RMS current vs. ambient temperature
77.11.x.xxx.82xx

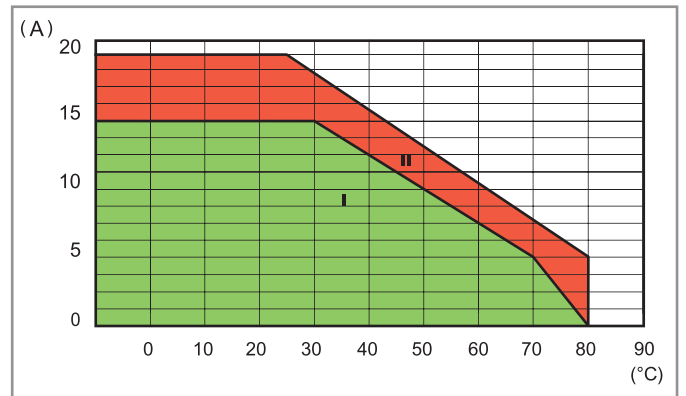

- I - Modular SSR installed as a group (without gap)
- II - Modular SSR installed individually in free air , or with a gap ≥ 20 mm, which implies a not significant influence from nearby components

Output specification

L77-3 Inrush peak current (AC) vs. time capacity
77.01.x.xxx.80xx

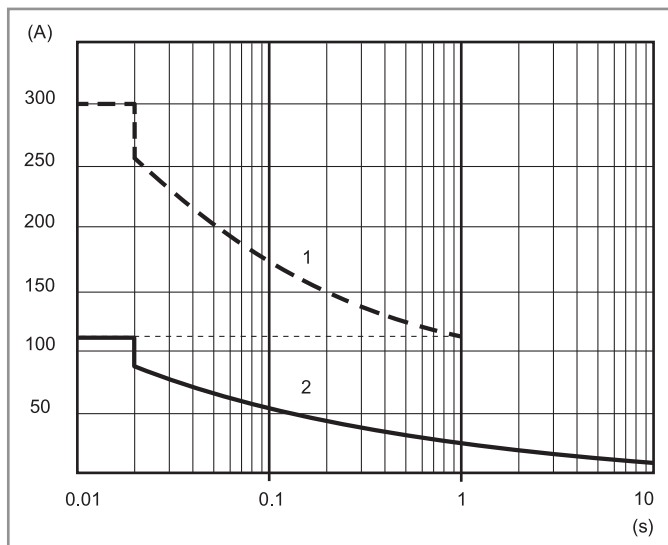

L77-5 Inrush peak current (AC) vs. time capacity
77.31.x.xxx.80xx

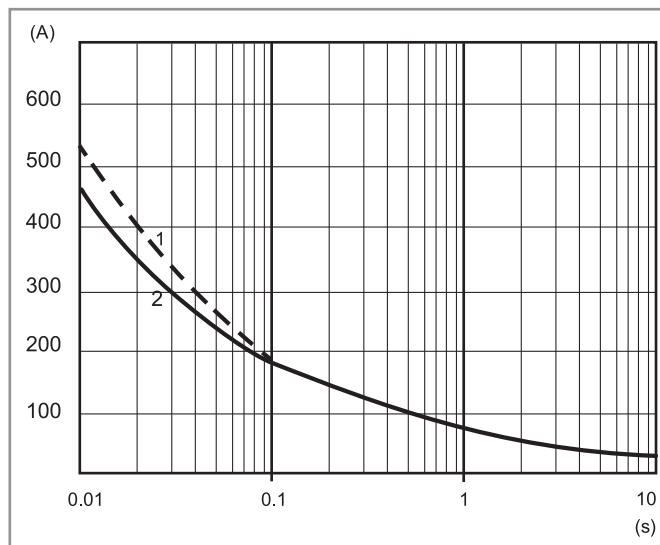

1 - "Cold" conditions (ambient temperature = 23 °C, no output current during the last 15 minutes)
2 - "Hot" conditions (ambient temperature = 50 °C, rated output current)

L77-7 Inrush peak current (AC) vs. time capacity
77.11.x.xxx.82xx

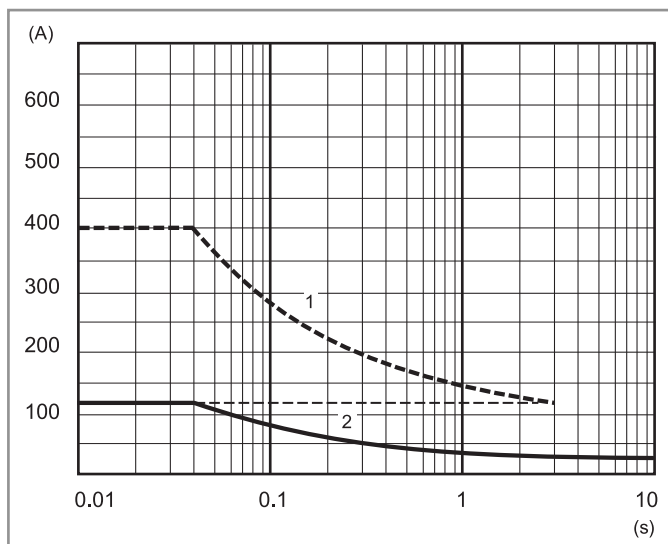

Max recommended switching frequency (Cycles/Hour, with 50 % Duty-cycle)

Load	77.01	77.31	77.11
5 A 230 V (AC1)	5,000	—	—
1A (AC15)	10,000	—	—
0.5 A (AC15)	20,000	—	—
30 A 480 V cos φ = 0.8	—	1,800	—
30 A 480 V cos φ = 0.5	—	1,200	—
15 A 305 V cos φ = 0.8	—	—	1,800
15 A 305 V cos φ = 0.5	—	—	1,200

Other data

	77.01	77.31	77.11
Critical rising voltage dv/dt @ T _j = 125 °C	> 1,000 V/μs	> 1,000 V/μs	> 500 V/μs (without input control) > 10 V/μs (with di/dt = 20 A/ms)
Critical rising current di/dt @ tr < 100 ns, T _j = 125 °C	> 50 A/μs	> 150 A/μs	> 50 A/μs
I ² t for fusing @ tp = 10 ms	450 A ² s	1,350 A ² s*	1,000 A ² s**

* Recommended fuse for short-circuit protection: 30 A, 660 V AC, 10x38 mm, 200 kA, 1,000 A²s.

** Recommended fuse: 20 A, 660 V AC, 10x38 mm, 200 kA, 360 A²s.

Wiring diagrams

Single-phase connection (77.01)

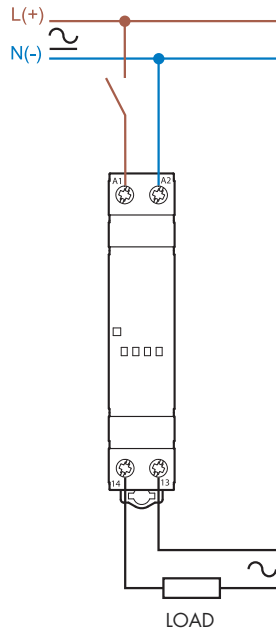

Single-phase connection (77.11)

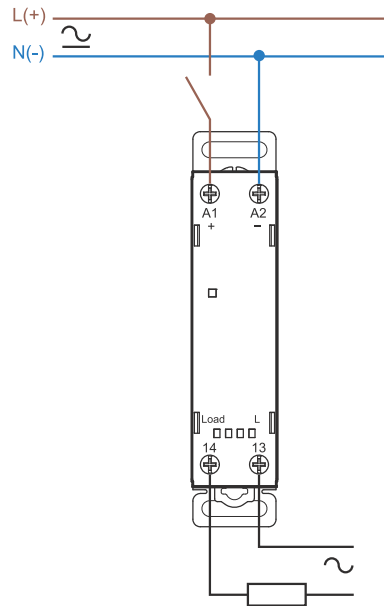

Single-phase connection (77.31.....5x)

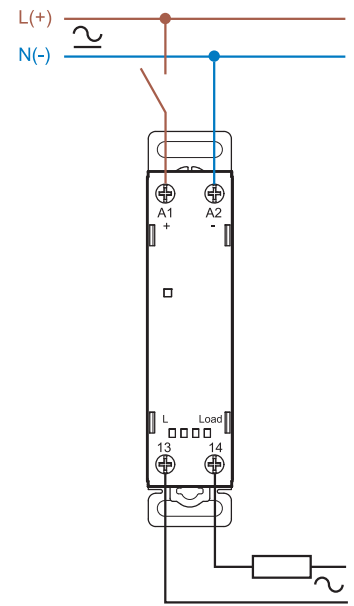

Single-phase connection (77.31.....7x)

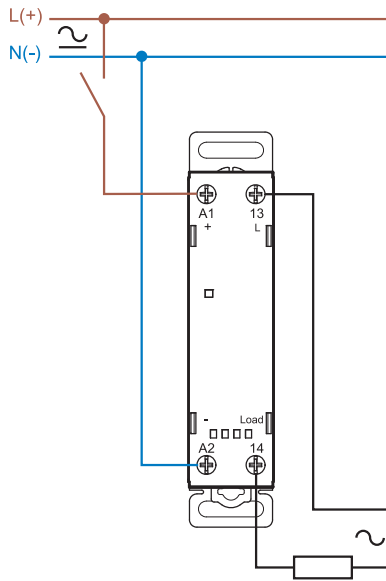

Example of three-phase connection (with 3 x 77.01.8.230.8051)

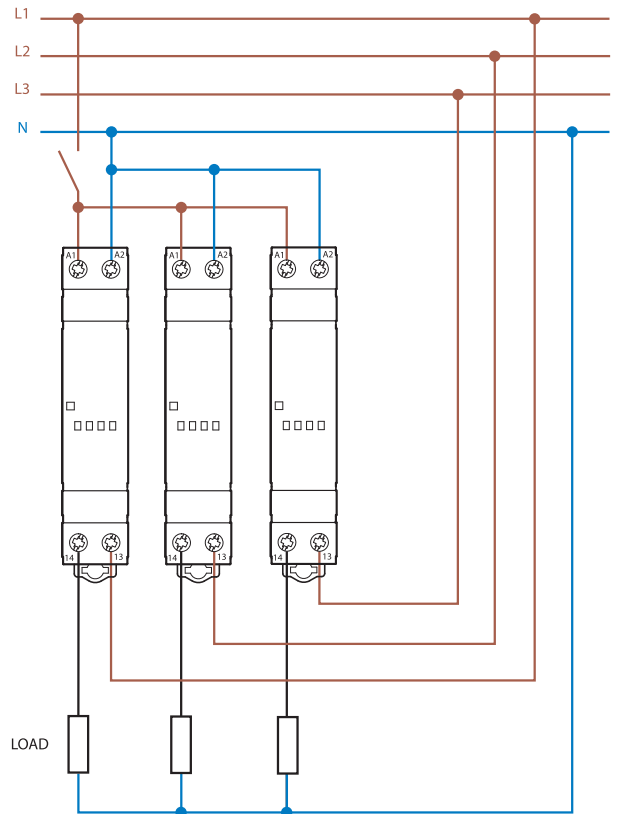

Outline drawings

77.01
Screw terminal

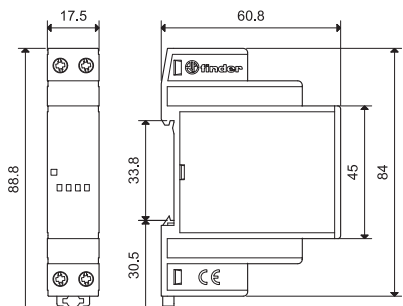

77.11/31
Screw terminal

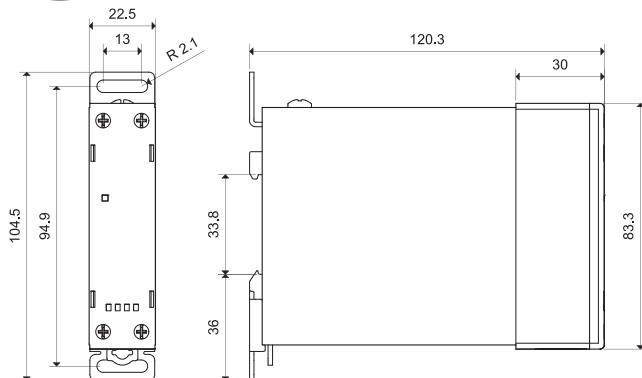

Accessories



020.01

Adaptor for panel mounting, plastic, 17.5 mm wide for 77.01 only

020.01

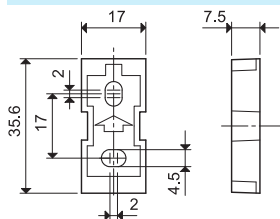

020.03

Separator for panel mounting, plastic, 3 mm wide

020.03

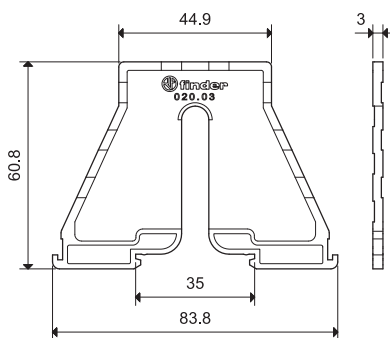

060.72

Sheet of marker tags, plastic, 72 tags, 6x12 mm

060.72