

WIDE BAND COMMUNICATION RECEIVER

# DJ-X11

## Instruction Manual



Thank you for purchasing your new Alinco receiver. This instruction manual contains important safety and operating instructions. Please read this manual carefully before using the product and keep it for future reference.

# NOTICE / Compliance Information Statement

This equipment has been tested and found to comply with the limits for a Class B digital device, pursuant to part 15 of the FCC Rules.

These limits are designed to provide reasonable protection against harmful interference in a residential installation.

This equipment generates, uses, and can radiate radio frequency energy and, if not installed and used in accordance with the instruction manual, may cause harmful interference to radio communications. However, there is no guarantee that interference will not occur in a particular modulation. If this equipment does cause harmful interference to radio or television reception, which can be determined by turning the equipment off and on, the user is encouraged to try to correct the interference by one or more of the following measures:

- Reorient or relocate the receiving antenna.
- Increase the separation between the equipment and receiver.
- Connect the equipment into an outlet on a circuit different from that to which the receiver is connected.
- Consult the dealer or an experienced radio/TV technician for help.



**Tested to Comply  
With FCC Standards  
FOR HOME OR OFFICE USE**

Information in this document is subject to change without notice or obligation. All brand names and trademarks are the property of their respective owners. Alinco cannot be liable for pictorial or typographical inaccuracies. Some parts, options and/or accessories are unavailable in certain areas. Changes or modifications not expressly approved by the party responsible for compliance could void the user's authority to operate the equipment.

## Wide Band Communication Receiver DJ-X11T

This device complies with Part 15 of the FCC Rules. Operation is subject to the following two conditions: (1) This device may not cause harmful interference, and (2) this device must accept any interference received, including interference that may cause undesired operation.

Manufacturer:

ALINCO, INC.  
Yodoyabashi Daibiru Building 13th Floor  
4-4-9, Koraihashi, Chuo-ku, Osaka 541-0043, JAPAN



### Conformity Information

Alinco, Inc. Electronics Division hereby declare on our sole responsibility that the product(s) listed below comply the essential requirements of the Directive 1999/5/EC, The council of 3/9/99 on Radio Equipment and Telecommunication Terminal Equipment and the mutual recognition of their conformity and with the provisions of Annex, after having performed the required measurements at Notified Bodies per Standards, and relative certificate(s) or document(s) can be reviewed at <http://www.alinco.com/Ce/>

DJ-X11E: Wide Band Communication Receiver	0.05 - 1299.99995MHz
DJ-X11EGR: Portable broadcast/hamband Receiver	0.522 - 1.62000MHz
	53.75 - 67.7500MHz
	87.60 - 107.9000MHz
	144.00 - 145.99995MHz
	180.75 - 229.7500MHz
	430.00 - 439.99995MHz
	476.75 - 860.7500MHz
	1260.00 - 1299.99995MHz

Function:	DJ-X11E	DJ-X11EGR
Inversion scramble decoder:	Available	N/A



DJ-X11E is authorized for use in all EU and EFTA member states except for Greece.  
DJ-X11EGR is authorized for use in all EU and EFTA member states.

#### DJ-X11E : Band-plan setting instruction

In Europe, there are slight differences in frequency allocation country by country. Therefore the DJ-X11E has been preprogrammed with different VFO and Preset tables(band-plans) so that it will become handy when you travel. Select one of the band-plans by pressing the numeric key as instructed below when turning on the unit.

#### The band plan

Hold 2key while turning on : Pan-Europe







Hold 3key while turning on : UK

Please refer(P. 110)for the details of the band-plans.

Copyright © All rights reserved. No part of this document may be reproduced, copied, translated or transcribed in any form or by any means without the prior written permission of Alinco. Inc., Osaka, Japan, English Edition Printed in Japan.







# Warning

To prevent any hazard during operation of Alinco's radio product, in this manual and on the product you may find symbols shown below. Please read and understand the meanings of these symbols before starting to use the product.

 <b>Danger</b>	This symbol is intended to alert the user to an immediate danger that may cause loss of life and property if the user disregards the warning.
 <b>Alert</b>	This symbol is intended to alert the user to a possible hazard that may cause loss of life and property if the user disregards the warning.
 <b>Caution</b>	This symbol is intended to alert the user to a possible hazard that may cause loss of property or injure the user if the warning is disregarded.
	Alert symbol. An explanation is given.
	Warning symbol. An explanation is given.
	Instruction symbol. An explanation is given.

## Alert

### ■ Environment and condition of use

-  Do not use this product in close proximity to other electronic devices, especially medical ones. It may cause interference to those devices.
-  Keep the radio out of the reach of children.
-  In case a liquid leaks from the product, do not touch it. It may damage your skin. Rinse with plenty of cold water if the liquid contacted your skin.
-  Never operate this product in facilities where radio products are prohibited for use such as aboard aircraft, in airports, in ports, within or near the operating area of business wireless stations or their relay stations.
-  Use of this product may be prohibited or illegal outside of your country. Be informed in advance when you travel.
-  The manufacturer declines any responsibilities against loss of life and/or property due to a failure of this product when used to perform important tasks like life-guarding, surveillance, and rescue.



Risk of explosion if battery is replaced with an incorrect type.  
Dispose of, or recycle used batteries according to your local regulations.



The manufacturer declines any responsibilities against loss of life and property due to a failure of this product when used with or as a part of a device made by third parties.



Use of third party accessory may result in damage to this product. It will void our warranty for repair.

### ■ Handling this product



Be sure to reduce the audio output level to minimum before using an earphone or a headset. Excessive audio may damage hearing.



Do not open the unit without permission or instruction from the manufacturer.  
Unauthorized modification or repair may result in electric shock, fire and/or malfunction.



Do not operate this product in a wet place such as shower room. It may result in electric shock, fire and/or malfunction.



Do not place the product in a container carrying conductive materials, such as water or metal in close proximity to the product. A short-circuit to the product may result in electric shock, fire and/or malfunction.

### ■ About chargers



Do not use adapters other than having the specified voltage. It may result in electric shock, fire and/or malfunction.



Do not plug multiple devices using an adapter into a single wall outlet. It may result in overheating and/or fire.



Do not handle adapter with a wet hand. It may result in electric shock.



Securely plug the adapter into the wall outlet. Insecure installation may result in short-circuit, electronic shock and/or fire.



Do not use the adapter if the plug or socket contacts are dirty. Overheating and/or short-circuiting may result in fire, electric shock and/or damage to the product.

### ■ About power supply



Use only appropriate, reliable power supply of correct voltage and capacity.



Do not connect cables in reverse polarity. It may result in electric shock, fire and/or malfunction.



Do not plug multiple devices including the power supply into a single wall outlet. It may result in overheating and/or fire.



Do not handle a power supply with a wet hand. It may result in electric shock.



Securely plug the power supply to the wall outlet. Insecure installation may result in short-circuiting, electronic shock and/or fire.



Do not plug the power supply into the wall socket if the contacts are dirty. Short-circuit and/or overheating may result in fire, electric shock and/or damage to the product.



Do not modify or remove fuse-assembly from the DC cable. It may result in fire, electric shock and/or damage to the product.

### ■ Cigar-lighter cable



Do not use the cable at any other than the specified voltage. It may result in electric shock, fire and/or malfunction.



Do not handle cigar cable with a wet hand. It may result in electric shock.

### ■ In case of emergency

In case of the following situation(s), please turn off the product, switch off the source of power, then remove or unplug the power-cord. Please contact your local dealer of this product for service and assistance. Do not use the product until the trouble is resolved.

Do not try to troubleshoot the problem by yourself.

- When a strange sound, smoke and/or strange odor comes out of the product.
- When the product is dropped or the case is broken or cracked.
- When a liquid penetrated inside.
- When a power cord (including DC cables, AC cables and adapters) is damaged.



For your safety, turn off then remove all related AC lines to the product and its accessories from the wall outlet if a thunderstorm is likely.

### ■ Maintenance



Do not open the unit and its accessories. Please consult with your local dealer of this product for service and assistance.



## Caution

### ■ Environment and condition of use



Do not use the product in proximity to a TV or a radio. It may cause interference or receive interference.



Do not install in a humid, dusty or insufficiently ventilated place. It may result in electric shock, fire and/or malfunction.



Do not install in an unstable or vibrating position. It may result in electric shock, fire and/or malfunction when/if the product falls to the ground.



Do not install the product in proximity to a source of heat and humidity such as a heater or a stove. Avoid placing the unit in direct sunlight.



Be cautious of a dew formation. Please completely dry the product before use when it happens.

## ■ About receiver



Be cautious of the whip antenna when carried in your shirt-pocket etc. It may make contact with your eye and cause injury.



Do not connect devices other than specified ones to the jacks and ports on the product. It may result in damage to the devices.



Turn off and remove the power source (AC cable, DC cable, battery, cigar cable, charger adapter etc.) from the product when the product is not in use for extended period of time or in case of maintenance.



Never pull the cord alone when you unplug AC cable form the wall outlet.



Use a clean, dry cloth to wipe off dirt and condensation from the surface of the product. Never use thinner or benzene for cleaning.

## ■ About power supply



Use only reliable power supply of specific DC output range and be mindful of the polarity of the cable and DC-jack.



Always turn off the power supply when connecting or disconnecting the cables.



When using an external antenna, make sure that the antenna ground is not common with the ground of the power supply.



European users: When a unit is powered from an external DC power source (adapter, power supply, cigar-plug etc.), make sure that this power supply has approval to the level of IEC/EN 60950-1.

## ■ Lightning

Any person is not safe outdoor during thunderstorm and lightning. This condition is getting worse if somebody keeps a hand-held radio; chances of being hit by lightning are doubled since lightning may hit a radio antenna as well. At this time, there is no hand-held radio having any kind of protection against lightning current (which is higher than 10 kA.). Note also that no car provides adequate protection of its passengers or drivers against lightning as well. Therefore, Alinco will not take responsibility for any danger associated with using its hand-held radios outdoor or inside the car during lightning.

## ■ Notice to California resident users

The Safe Drinking Water and Toxic Enforcement Act of 1986 of the State of California determines that lead and cadmium are considered carcinogens and reproductive toxicants. The product that comes with this manual is free from dangerous materials such as lead and cadmium as per RoHS order of EU.

## ■ Limited Power Source

Please note that the receiver enclosure only provides mechanical protection of its internal parts; it will not contain a fire within the device if the fire starts under certain fault conditions. Alinco will not take responsibility for any fire hazard associated with powering the receiver or charging its batteries using a power source which does not belong to the limited power sources in the meaning of EN 60950-1. Excluded from possible use with the receiver are most car cigarette lighters and some DC (AC/DC) power supplies. Make sure that the power supply used with the receiver is a limited power source.

# Introduction

Thank you very much for purchasing this excellent Alinco receiver. Our products are ranked among the finest in the world. This radio has been manufactured with state of the art technology and it has been tested carefully at our factory. It is designed to operate to your satisfaction for many years under normal use.

PLEASE READ THIS MANUAL COMPLETELY TO LEARN ALL THE FUNCTIONS THE PRODUCT OFFERS. WE MADE EVERY ATTEMPT TO WRITE THIS MANUAL TO BE AS COMPREHENSIVE AND EASY TO UNDERSTAND AS POSSIBLE. IT IS IMPORTANT TO NOTE THAT SOME OF THE OPERATIONS MAY BE EXPLAINED IN RELATION TO INFORMATION IN PREVIOUS CHAPTERS. BY READING JUST ONE PART OF THE MANUAL, YOU RISK NOT UNDERSTANDING THE COMPLETE EXPLANATION OF THE FUNCTION.

“TV” as used in this manual refers to analog television.



# Table of Contents

1. Features .....	12
2. Checking the Accessories .....	13
3. Attaching Accessories .....	14
3-1 Antenna .....	14
3-1-1 Attaching the antenna .....	14
3-1-2 Removing the antenna .....	14
3-2 Hand Strap .....	14
3-3 Belt Clip.....	15
3-3-1 Attaching the belt clip .....	15
3-3-2 Removing the belt clip.....	15
3-4 Battery Pack.....	15
3-4-1 Attaching the battery pack .....	15
3-4-2 Removing the battery pack .....	16
3-5 Charging the Battery Pack through the DC Jack .....	17
3-6 Charging the Battery Pack with the Charger .....	18
3-7 Preventing the Battery Pack from Short-circuiting .....	18
3-8 Dry Battery Case .....	19
3-9 Battery Level Icons .....	20
4. Part Names and Operation .....	21
4-1 Part Names and Functions of the Receiver .....	21
4-1-1 Top and front panels .....	21
4-1-2 Side panels .....	22
4-1-3 Key operation .....	23
4-2 LCD Display .....	24
5. Basic Operation .....	25
5-1 Turning the Power ON .....	25
5-2 Tuning the Frequency.....	25
5-3 Adjusting the Volume Level .....	25
5-4 Adjusting Squelch Level.....	26
5-4-1 Operating procedure .....	26
5-5 Monitor function .....	27
5-6 Mute Function .....	27
5-7 Selecting the Band to Operate .....	28
5-7-1 Mono-band operation .....	28
6. Operating Modes .....	29
6-1 Setting frequencies in VFO mode.....	30
6-2 Setting the Channel Step Frequency .....	30
6-3 1 MHz UP/DOWN Operation .....	30
6-4 Setting Frequencies through Direct Input .....	31
6-5 Setting frequencies in Preset mode .....	31
6-6 Receiving Operation .....	32
7. Memory Mode .....	34
7-1 Memory Types and Usage.....	34
7-2 Programming a Memory Channel.....	35
7-3 Calling Up a Memory Channel .....	38
7-4 Deleting a Memory Channel .....	38
7-5 Editing a Memory Channel.....	39

1

2

3

4

5

6

7

8

9

10

11

12

13

14

15

16

17

7-6 Quick Memory .....	40
7-6-1 Programming a memory channel to the quick memory .....	40
7-6-2 Calling up a memory channel from the quick memory .....	40
7-7 Memory Skip Function .....	40
7-8 Memory Naming Function .....	41
<b>8. Functions Assigned to the Key Pad .....</b>	<b>48</b>
8-1 Shortcut Function .....	48
8-2 Receiving Sensitivity (RF Gain) Adjustment and Attenuator Function .....	48
8-3 Switching the Modulation Mode .....	50
8-4 Setting the Tone Squelch/DCS .....	51
8-4-1 Tone Squelch function.....	51
8-4-2 DCS function .....	53
8-5 Bank Link Setting Function .....	54
8-6 Priority Monitoring Function .....	55
8-7 Received Sound Quality Adjustment Function .....	56
8-8 Frequency Shift Function .....	57
8-8-1 Setting the Frequency Shift function.....	57
8-8-2 Using the function .....	57
8-9 Changing the Channel Step .....	58
8-10 Channel Scope Function .....	59
8-10-1 VFO Channel Scope.....	60
8-10-2 Memory Channel Scope .....	61
8-11 Copying the Memory Channel Data into VFO Mode .....	62
8-12 F Tuning Function .....	62
<b>9. Useful Functions .....</b>	<b>63</b>
9-1 Key-lock Function .....	63
9-1-1 Key-lock procedure .....	63
9-1-2 Operations available while the Key-lock is active .....	63
9-2 Scanning Function .....	64
9-3 VFO Scan .....	64
9-4 Preset Scan .....	65
9-5 Memory scan .....	65
9-6 Programmed Scan .....	66
9-7 Tone Scan.....	66
9-8 DCS Scan.....	67
9-9 Sweep Scan.....	68
9-10 Bug Detector Function .....	69
9-10-1 Operating procedure in Silent mode .....	69
9-10-2 Operating procedure in Sound mode.....	70
9-10-3 Mode coupling setting of the Bug Detector function .....	71
9-10-4 Sensitivity setting of the Bug Detector function .....	72
<b>10. Set Mode Configurations .....</b>	<b>73</b>
10-1 Receiver Setting .....	74
10-1-1 Bar antenna setting .....	74
10-1-2 Earphone antenna setting .....	75
10-1-3 Preset mode setting .....	75
10-1-4 CW setting .....	76
10-1-5 Detected signal output function .....	76
10-1-6 F Tuning function operation setting .....	77
10-1-7 IQ signal output function .....	77
10-2 Screen Display Setting.....	78
10-2-1 Language setting .....	78
10-2-2 Illumination setting.....	78
10-2-3 Contrast setting .....	79
10-2-4 Font size setting.....	79
10-2-5 Font style setting .....	79
10-2-6 Welcome screen setting .....	80

10-3 Power and Battery Setting .....	81
10-3-1 Auto power off setting .....	81
10-3-2 Battery setting .....	82
10-3-3 Battery save function setting .....	82
10-4 Key Assignment Setting .....	83
10-4-1 Key-lock mode setting .....	83
10-4-2 Set mode exit time setting .....	84
10-4-3 Band transition setting .....	84
10-4-4 Right/left dial function setting .....	85
10-4-5 Upper/lower dial function setting.....	85
10-4-6 Assigning a function to the WILD key.....	86
10-4-7 Assigning a function to the MONI key .....	86
10-4-8 Setting the band operated with the MONI key .....	86
10-4-9 MONI key activation setting .....	87
10-4-10 MONI key setting.....	87
10-4-11 Remote COM port setting .....	88
10-5 Scan Setting .....	88
10-5-1 Scan mode setting.....	88
10-5-2 Priority Monitoring interval setting .....	89
10-5-3 Priority Monitoring duration setting.....	90
10-5-4 Skip scan operation setting .....	90
10-5-5 Scan speed setting .....	91
10-6 Memory Setting .....	91
10-6-1 Write-protect (memory protection) function setting .....	91
10-6-2 Memory name display setting .....	92
10-7 Sound Setting .....	92
10-7-1 Beep setting .....	92
10-7-2 Bell function setting .....	93
10-7-3 Voice Guidance function setting .....	94
10-8 Remote Controller Setting .....	95
11. Channel Display Mode .....	96
12. Cable-clone and PC Connection Functions .....	97
12-1 PC Connection and Connection Ports .....	97
12-2 Cable-Clone Receiving Data .....	99
12-3 Cable-Clone Transferring Data .....	100
13. Reset Function .....	101
13-1 Reset .....	101
14. Using the Optional Remote Controller .....	102
14-1 Using the Remote Controller .....	102
14-1-1 Top/Bottom/Front panels .....	102
14-1-2 Side panel .....	102
14-2 Connecting the Remote Controller.....	103
14-3 Remote Controller Functions .....	103
15. Maintenance and Reference .....	104
15-1 Troubleshooting.....	104
15-2 Optional Accessories List.....	105
15-3 After-sales Service .....	106
16. Index .....	107
17. Specifications .....	109
17-1 Specifications.....	109
17-2 The Band-plans .....	110
17-2-1 Switching the main band .....	110
17-2-2 Switching the sub band .....	112

1

2

3

4

5

6

7

8

9

10

11

12

13

14

15

16

17

# 1. Features

The DJ-X11 is a multifunctional receiver which receives a wide range of radio signals from low-frequency (LF) signals to ultra-high-frequency (UHF) signals. It provides the following features:

- 1** Receives a wide range of frequencies - between 0.05 and 1299.99995 MHz - including aviation radio and business communication frequencies.
- 2** Dual-frequency simultaneous reception for receiving signals with main and sub bands simultaneously. (The frequencies which can be received with the sub band are limited.)
- 3** Various reception modes supported including SSB/CW as well as FM/WFM/AM. The DJ-X11 can receive not only AM/FM radio signals and analog TV sounds, but also SSB mode signals which are used for amateur band Morse code and ship/aviation radios.
- 4** F Tuning function which quickly tunes to the very strong RF signal and receives it, if such signal may exist.
- 5** Built-in bar-antenna receives AM radio , eliminating the need to attach an external antenna.
- 6** Earphone cord can be used as an antenna to receive FM broadcast and other stronger signals without using an external antenna.
- 7** Automatic input switching. By connecting the optional remote controller to the earphone jack and connecting an MP3 player or other portable audio device to the controller, you can listen to music under normal conditions and hear receiver messages when the DJ-X11 receives any signals.
- 8** Bug Detector function in two modes. This function notifies you of the possible presence of a bugging device (wireless microphone) with a display, an alarm and a voice announcement.
- 9** Clone function for copying settings and various data between the receiver units. It is also possible to connect the receiver to a personal computer to edit settings and data.
- 10** Tone Squelch and DCS, cut off shrill and rattling noises so that only the target sound can be heard.
- 11** Scan speed is selectable from 3 levels. Select a fast scan speed to detect strong signals, and select a slower scan speed to detect weak signals.
- 12** Voice Guidance function which announces the result of key operations or the Bug Detector function in English.

## 2. Checking the Accessories

# 2

The package of the DJ-X11 contains the following items. Check that all items are included in your package before using the receiver.

- Instruction Manual (this manual)
- Warranty certificate (T/K versions only)
- Dry battery case (EDH-36)
- Lithium ion battery pack (EBP-74 3.7 V, 1800 mAh)
- AC adapter (EDC-139; T/K EDC-140; E/EGR)
- Charger stand (EDC-174)
- Whip antenna (SMA/EA-154)
- Belt clip (EBC-23)
- Hand strap

Standard accessory may vary depending on the model you have purchased. Please consult with your Alinco dealer of the details before purchase.

# 3. Attaching Accessories

## 3

### 3-1 Antenna

#### 3-1-1 Attaching the antenna

- 1** Hold the antenna at its base and rotate it clockwise (to the right).
- 2** When you cannot rotate the antenna further, confirm that it is securely attached to the receiver.

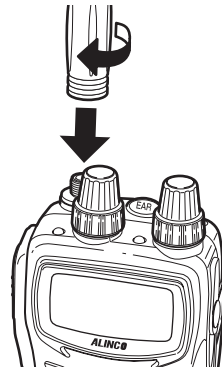

**MEMO**

- To avoid breakage, the supplied antenna is made of a more flexible material than that of typical antennae.
- This connector is also used for the connection of an external antenna.

#### 3-1-2 Removing the antenna

- 1** Rotate the antenna counterclockwise (to the left).

### 3-2 Hand Strap

- 1** Attach the hand strap to the hole on the rear of the receiver as shown in the figure.

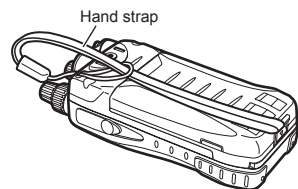

## 3-3 Belt Clip

### 3-3-1 Attaching the belt clip

- 1** Align the belt clip with the groove at the rear of the receiver to secure it, insert the screw into the hole and rotate it clockwise (to the right).

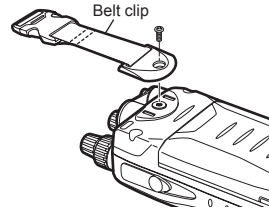

- 2** Check that the belt clip is securely attached to the receiver.

- \* The screw may become loose during use. Check the tightness from time to time.
- \* The belt clip can be adjusted so that it can be used for a belt of approximately 8 cm width at maximum.

### 3-3-2 Removing the belt clip

- 1** Rotate the screw counterclockwise (to the left) and remove the belt clip.

## 3-4 Battery Pack

For the procedure for charging the lithium ion battery pack (EBP-74), refer to “Charging the Battery Pack with the Charger” (P. 18) and “Charging the Battery Pack through the DC Jack” (P. 17).

### 3-4-1 Attaching the battery pack

- 1** Align the hooks of the battery pack with the grooves of the receiver and push in the battery pack in the direction of arrow (1).
- 2** Slide the lock lever at the bottom of the battery pack in the direction of arrow (2).

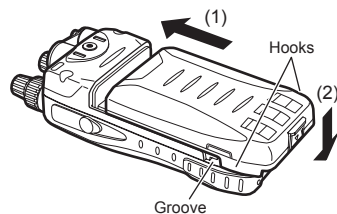

### 3-4-2 Removing the battery pack

- 1** Slide the lock lever at the bottom of the battery pack in the direction of arrow (1) and remove the battery pack (2).

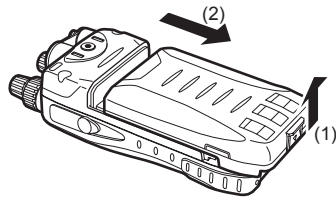

CAUTION

- The battery pack is not fully charged when shipped. You need to charge it after purchase before use.
- The battery pack must be charged within the temperature range of 0 to 40°C.
- Do not modify or dismantle the battery pack and do not throw it into fire or water. These actions are dangerous.
- Do not short-circuit the battery pack terminals. This may damage the equipment, or may cause burns by the heat generated from the battery. Do not charge the battery pack for an unnecessarily long time (over-charging). This may deteriorate battery performance.
- The battery pack should be stored in a dry place where the temperature range is between -10°C and +45°C. Storing the battery pack in locations with high humidity or temperatures outside the proper range may cause the battery solution to leak or the metal sections to rust.
- The battery pack is a consumable article. When the battery pack becomes exhausted extremely quickly even when it has been charged for the specified time, it may have reached the end of its life. In such a case, replace the battery pack with a new one.
- The battery pack is a recyclable resource. Do not dispose the battery pack but take it to a battery recycling center in your area. The battery pack is dedicated for use in Alinco products. It can be charged only using the applicable genuine charger or conforming receiver. Charging it with commercially-available or third-party chargers or adapters may cause a breakage or accident. Clean the electrodes of the battery pack and charger with a dry cotton swab from time to time.
- Even if you do not use the battery pack for a long time, charge it at least once every three months to prevent deterioration.
- The supplied battery pack is dedicated for use in the DJ-X11. Charging it with chargers or adapters other than specified models may cause a breakage or accident.



## 3-5 Charging the Battery Pack through the DC Jack

The supplied lithium ion battery pack can be charged through the DJ-X11 by using the supplied AC adapter and a DC power supply (6 VDC, 1 A or more: IEC/EN60950 standard). It takes about six hours to fully charge the battery pack from a state of complete discharge.

**1 Attach the battery pack by referring to “Battery Pack” (P. 15).**

**2 Connect the plug of the AC adapter into the DC jack of the DJ-X11 and plug the AC adapter into a wall outlet.**

\* Your AC adapter may have a different shape from the AC adapter shown in the figure.

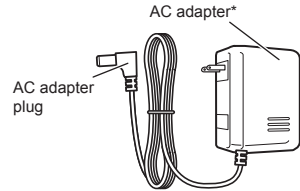

For the battery level indication during charging, refer to “Battery Level Icons” (P. 20).



- When the receiver is used with the supplied AC adapter connected, the reception may be affected by noise; however, this is not a malfunction.



- Also read the precautions supplied with the optional accessories carefully to ensure proper use and safety.
- If the voltage of the wall outlet is not stable, the battery pack may not be charged properly.

## 3-6 Charging the Battery Pack with the Charger

Using the supplied charger completes charging in about four hours from a state of complete discharge.

- 1** Connect the plug of the AC adapter to the charger.
- 2** Plug the AC adapter into a wall outlet and place the DJ-X11 on the charger.

During charging, the red lamp of the charger illuminates.

When the charging is complete, the lamp goes off.

EDC-174 doesn't charge when EBP-74 is fully charged and the red lamp stays off.

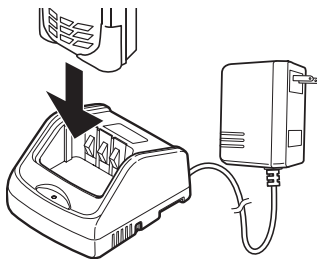

**MEMO**

- If charging fails with the battery pack attached to the receiver, try charging the battery pack alone and check the operation.
- The battery pack can also be charged by using the optional PC connection cable (ERW-8). (About eight hours)

## 3-7 Preventing the Battery Pack from Short-circuiting

Take extreme caution when carrying the battery pack. A current surge caused by short-circuiting may cause a fire.

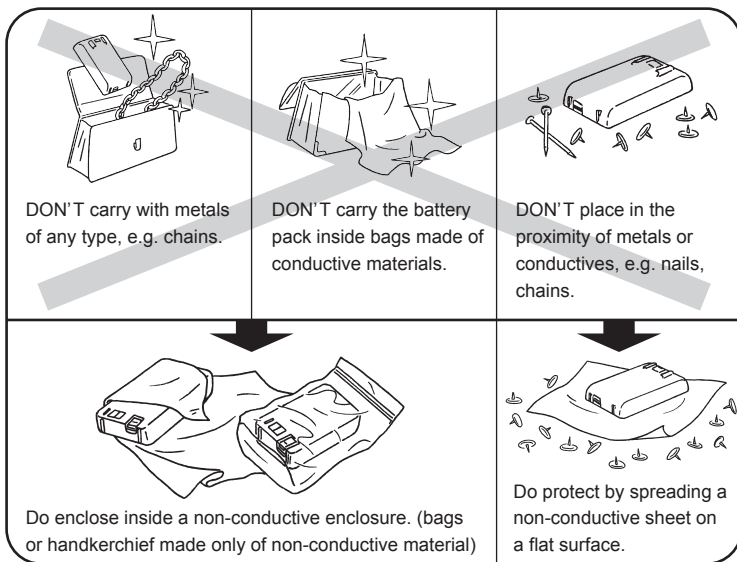

## 3-8 Dry Battery Case

- 1 Push up tab (1) and remove the lid.

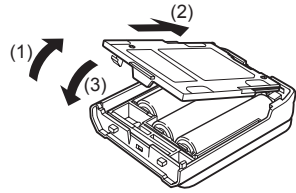

- 2 Set three AA dry batteries in the case and close the lid in the order of 2 and 3. Check that the lid is closed securely. You must use alkaline dry batteries. Manganese dry batteries cannot be used.

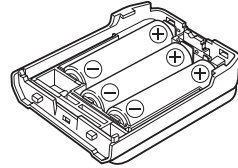

MEMO

- To use dry batteries, read the instructions in “Battery setting” (P. 82).



CAUTION

### Precautions on using the dry battery case

- Be careful of the orientation of the batteries. Inserting them in the incorrect orientation may cause electrical leakage, fire, or explosion.
- Use new dry batteries of the same type and manufacturer.
- When replacing the batteries, replace all batteries with new ones.
- Rechargeable batteries must not be used. Alinco assumes no responsibility for any property damage or physical injuries resulting from the use of rechargeable batteries.
- Clean the electrodes which make contact with the dry batteries with a clean, dry cloth or cotton swab from time to time.
- Using batteries of the wrong type may cause an explosion.

## 3-9 Battery Level Icons

The battery icon displayed on the LCD of the DJ-X11 indicates the remaining battery power. When the battery icon indicates empty, charge the battery pack or replace the dry batteries with new ones.

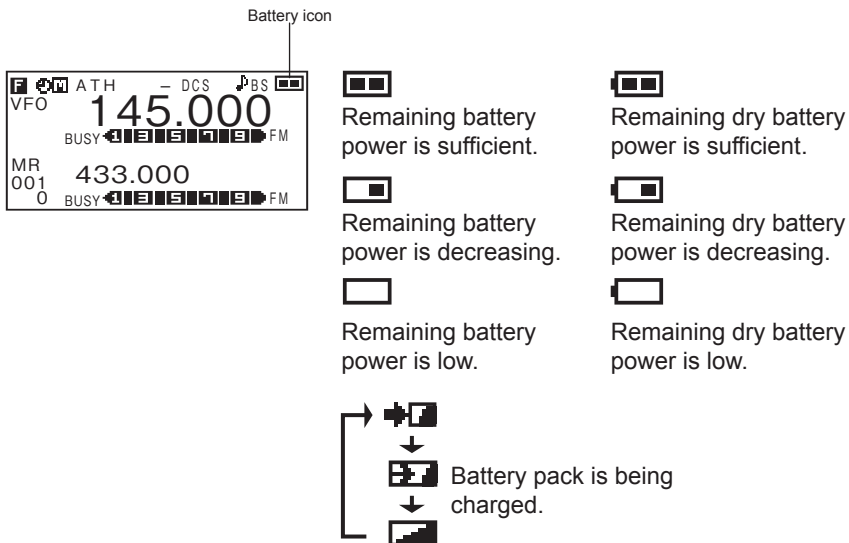

When the receiver is turned OFF, “Charging” is displayed on the LCD. When the charging is complete, “Charge completed” is displayed.

# 4. Part Names and Operation

## 4-1 Part Names and Functions of the Receiver

### 4-1-1 Top and front panels

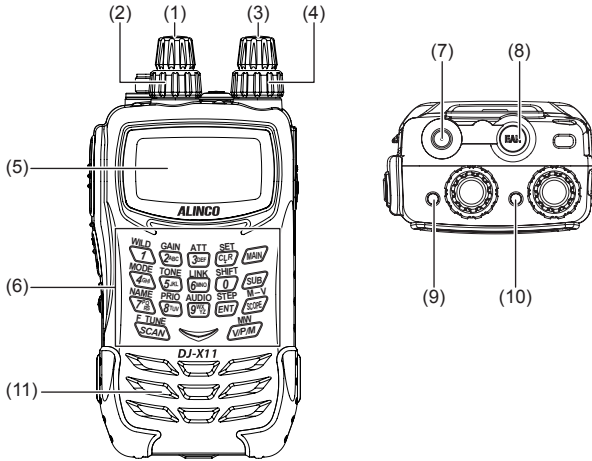

No.	Name	Function
(1)	Upper main dial	Rotate the dial to change the frequency/memory channel or to set items for the main band. Pressing this dial while <b>F</b> is displayed switches the receiver to the mode coupling setting of the Bug Detector function.
(2)	Lower main dial	Rotate the dial to change audio volume or set items for the main band.
(3)	Upper sub dial	Rotate the dial to change the frequency/memory channel or set items for the sub band. Pressing this dial while <b>F</b> is displayed switches the receiver to the sensitivity setting of the Bug Detector function.
(4)	Lower sub dial	Rotate the dial to change audio volume or set items for the sub band.
(5)	LCD	The status of the receiver is displayed. Refer to "LCD Display" for details.
(6)	Key pad	Use these keys for direct frequency input or various settings.

No.	Name	Function
(7)	Antenna connector (SMA)	Attach the supplied antenna securely. To use other antennae, select an antenna which has been tuned to operate within the specified operating frequency range.
(8)	Earphone jack	Used to connect an external earphone.
(9)	Main RX lamp	This lamp illuminates in green while the main band squelch is open.
(10)	Sub RX lamp	This lamp illuminates in green while the sub band squelch is open.
(11)	Speaker	A low-profile, built-in speaker is provided.

### 4-1-2 Side panels

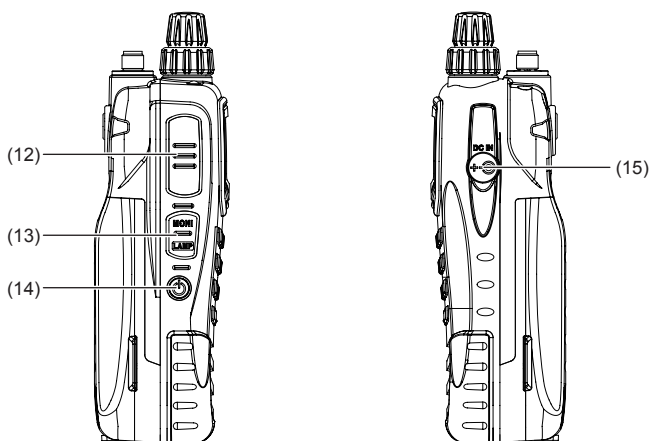

No.	Name	Function
(12)	FUNC key	Use this key in combination with other keys to use various functions. Rotating the upper main/sub dial while holding down this key changes the frequency by 1 MHz. Holding down this key (approx. 1 second) activates/deactivates the Quick Key-lock function.
(13)	MONI key (LAMP key)	Press this key to open the squelch and hear the received sound.
(14)	POWER key	Hold down this key (approx. 1 second) to turn ON/OFF the receiver.
(15)	DC jack	This is an external power supply connection terminal. Connect the supplied AC adapter, or connect the optional cigarette lighter cable to use the receiver in a car. To use a stabilized power supply, be sure to use a power supply of 6.0 VDC and 1 A or higher.

## 4-1-3 Key operation

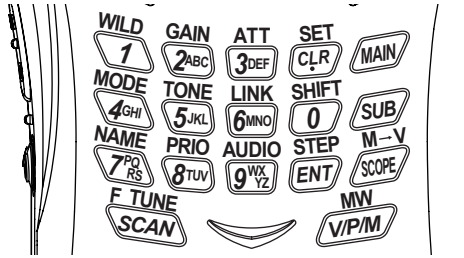

4

Name	Function	After the FUNC Key is Pressed	Hold Down the Key (Approx. 1 Second)	Hold Down the Key and Operate the Dial
1	Enter 1.	WILD key	Program/cancel the quick memory (in Memory mode).	
2	Enter 2.	Adjust the receiving sensitivity.		
3	Enter 3.	Set the Attenuator.		
4	Enter 4.	Switch the modulation mode.		
5	Enter 5.	Set the Tone Squelch/DCS		
6	Enter 6.	Set the bank link.		
7	Enter 7.	Set the memory name.		
8	Enter 8.	Priority Monitoring function		
9	Enter 9.	Received Sound Quality Adjustment function		
0	Enter 0. (rev)	Frequency Shift function		
.	Enter a decimal point. (CLR)	Call up Set mode.		
ENT	Determine the entry.	Channel step		
MAIN	Switch bands/banks.	Edit the memory channel.		
SUB	Switch bands/banks.	-	Switch the sub band between dual-/mono-band.	
SCOPE	Channel Scope function	M→V function		
V/P/M	Switch operation modes.	Program/clear the memory channel.		
SCAN	SCAN key	F Tuning function		

## 4-2 LCD Display

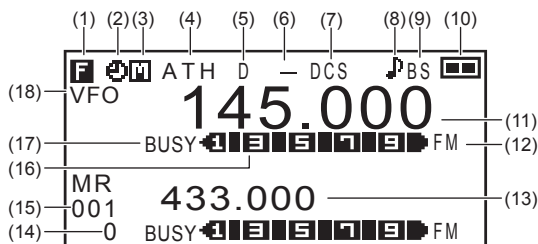

No.	Indication	Function
(1)	<b>[F] / [M] / [K]</b>	Appears when the [FUNC] key is pressed or when the Key-lock is activated (P. 63).
(2)	<b>[Power Off]</b>	Appears while the Auto Power OFF function is ON (P. 81).
(3)	<b>[M] / [S]</b>	Indicates the band to be operated. (P. 28)
(4)	<b>ATH / ATH</b>	Appears while the Attenuator function is ON (P. 48, P. 49).
(5)	<b>D</b>	Appears while the Detection Signal Output function is ON (P. 76).
(6)	<b>- / +</b>	Indicates the frequency shift direction. (P. 57)
(7)	<b>TSQ / SQ / DCS</b>	Appears while the Tone Squelch/DCS is ON (P. 51 - P. 53).
(8)	<b>[Bell]</b>	Appears while the Bell function is ON (P. 93).
(9)	<b>BS</b>	Appears while the Battery Save function is ON (P. 82, P. 83).
(10)	<b>[Battery]</b>	Indicates the remaining power of the battery pack/dry batteries. (P. 82)
(11)	<b>145.000</b>	Indicates the frequency of the main band.
(12)	<b>FM</b>	Indicates the modulation mode (FM, Wide FM, AM, USB, LSB, CW). (P. 50)
(13)	<b>433.000</b>	Indicates the frequency of the sub band.
(14)	<b>0</b>	Indicates the memory bank No. (P. 34 - )
(15)	<b>001</b>	Indicates the memory channel No. (P. 34 - )
(16)	<b>[Reception Level]</b>	Indicates the reception level.
(17)	<b>BUSY / MUTE</b>	Appears while the squelch is open or while the Mute function is ON (P. 26, P. 27, P. 86, P. 87).
(18)	<b>VFO</b>	Indicates the operation mode status. (P. 29 - P. 33)



# 5. Basic Operation

## 5-1 Turning the Power ON

- 1** Hold down the  [POWER] key (approx. one second) to turn the power ON.

Hold down the key again to turn the power OFF.



MEMO

- Due to utilize the capacity of the battery in full to maximize the operating time, a special tune has been performed to the circuit of the DJ-X11. For this reason, you may encounter an event that the unit can't be turned on after the battery pack is completely discharged and turned off by itself. In this case, remove any power source (the battery pack, dry cell case and external DC cable/adaptor) from the unit, wait for 5 seconds or so, then supply one of correct DC power sources again to turn on. At this status, even an empty battery pack should work with an AC adapter.

## 5-2 Tuning the Frequency

For the procedure to select the band to tune, refer to (P. 28).

- **Tuning the frequency for the main band**

Rotate the upper main dial.

- **Tuning the frequency for the sub band**

Rotate the upper sub dial.

Rotating the dial clockwise sets the frequency higher; rotating the dial counterclockwise sets the frequency lower.

## 5-3 Adjusting the Volume Level

Volume can be adjusted within the range of 31 levels from 0 to 30.

The default is set to 10.

When you hold down the [MONI] key, you will hear a hissing sound. Use this sound as a guide for adjustment.

- **Adjusting the volume of the main band**

Rotate the lower main dial.

- **Adjusting the volume of the sub band**

Rotate the lower sub dial.

Rotating the dial clockwise increases the volume; rotating the dial counterclockwise decreases the volume.

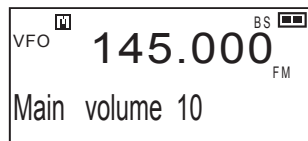



- When using earphones, be careful that the volume is not set too loud. Start from a low level and gradually increase it while actually listening to the sound.



#### When nothing is heard

- When the squelch is closed or the Mute function is activated, you will hear nothing even if you increase the volume level. For details, refer to the following sections “Adjusting Squelch Level” (P. 26) and “Mute Function” (P. 27).

## 5

### 5-4 Adjusting Squelch Level

#### • What is “squelch”?

The Squelch function activates the speaker only when signals at a specified level or higher are received. This makes it easier to catch target signals by eliminating the noise which occurs when no signals are received. When the squelch level is increased, the receiver can receive strong signals, but cannot receive weak signals.

“To open the squelch” means to deactivate the squelch. “To close the squelch” means the opposite. The strength of the signals required to open the squelch is determined by the squelch setting level. This level is adjustable because it varies in some degree depending on the location of signal reception and receiving frequency.

The squelch can be adjusted within the range of 10 levels (0 to 9).

#### 5-4-1 Operating procedure

##### • Adjusting the squelch for the main band

Press the main dial once and rotate it.

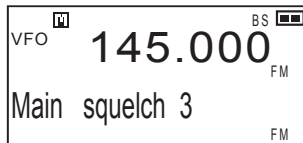

##### • Adjusting the squelch for the sub band

Press the sub dial once and rotate it.

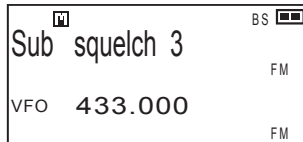

Rotating the dial clockwise sets the squelch level higher; rotating the dial counterclockwise sets the squelch level lower.

- To keep the squelch constantly open, set the squelch level to 0.
- While the squelch is open, scanning is disabled except for the periodic scan. To enable scanning, adjust the squelch level until you cannot hear any noise.

## 5-5 Monitor function

The Monitor function forces the squelch to open. When receiving signals are relatively weak or are often interrupted, it opens the squelch temporarily, regardless of the current squelch level. This function is activated when the “Monitor key operation setting” (P. 87) is set to the Monitor function.

There are two options for the Monitor function: PUSH and HOLD. When the [MONI] key is pressed, both options open the squelch and the “**BUSY**” appears on the LCD.

- For the procedure to switch between PUSH and HOLD, refer to “Monitor key operation setting” (P. 87)
- When PUSH is selected, the squelch opens only while the [MONI] key is held down. When the [MONI] key is released, the squelch returns to the original level.
- When HOLD is selected, the squelch remains open once the [MONI] key is pressed. When the [MONI] key is pressed again, the squelch returns to the original level.



**MEMO**

- When the Monitor function is used, the Tone Squelch and DCS functions is also disabled temporarily.
- If you cannot receive any signals and suspect a malfunction, use this function to check if the receiver can receive signals properly.

## 5-6 Mute Function

The Mute function silences sounds. It cuts off audio outputs even when signals are received. This function is activated when the “MONI key setting” (P. 87) is set to the Mute function. This function is useful when you want to silence the sound with one key touch without adjusting the volume.

There are two options for activating the Mute function: PUSH and HOLD. When the [MONI] key is pressed, either option activates the Mute function and “**MUTE**” illuminates on the LCD.



**MEMO**

- Only one of the Monitor function and Mute function can be selected at a time.

## 5-7 Selecting the Band to Operate

Select either the main band or sub band to operate.

Refer to (P. 33) for the range of the receivable frequencies for each band.

### 1 Press the key or key to select the band to operate.



When the dual-band display is selected, the frequency of the selected band is displayed in larger letters. When the mono-band display is selected, only the frequency of the selected band is displayed.

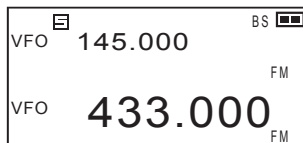

### 2 Pressing the key or key again changes the band.



MEMO

- By holding down the  key and rotating the upper dial, you can change the band quickly.
-  indicates that the main band is currently selected for operation;
-  indicates that the sub band is currently selected for operation.

### 5-7-1 Mono-band operation

#### • Using the main band with mono-band operation

### 1 Hold down the key (approx. one second).

The main band is displayed with the mono-band display. To return to the dual-band display, repeat the same operation again.

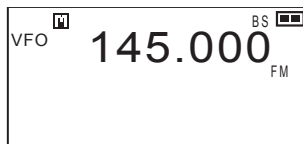

#### • Using the sub band with mono-band operation

### 1 Hold down the key (approx. one second).

The sub band is displayed with the mono-band display. To return to the dual-band display, repeat the same operation again.

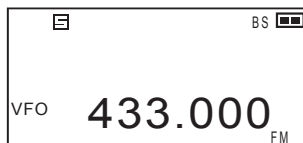

# 6. Operating Modes

The DJ-X11 has three operating modes: VFO, Preset, and Memory.

VFO mode	VFO stands for Variable Frequency Oscillator. You can select a desired frequency by rotating the dial. You can operate the receiver like a normal radio.
Preset mode	The audio frequencies for AM/FM radio and TV channels have already been set so that you can choose among them just like a conventional radio.
Memory mode	You can program frequencies to memory channels beforehand and call up one when you wish. For the frequency programming procedure, refer to "Memory Mode"(P. 34). This function is similar to the address book of a mobile phone.



CAUTION

- For TV sound channels, only analog terrestrial broadcasting can be received. The TV sound from digital terrestrial broadcasting cannot be received.

- Switching between operating modes

Pressing the  key changes operating modes in the following order.

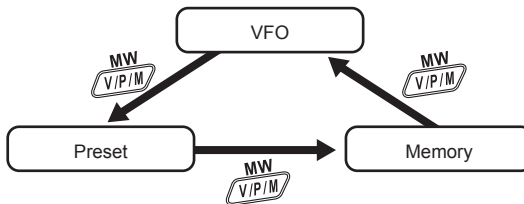

MEMO

- The preset mode can be excluded from the operation modes.
- For details, refer to "Preset mode setting (P. 75).

## 6-1 Setting frequencies in VFO mode

The VFO mode is a mode displayed when you turn ON the DJ-X11 for the first time with the factory default setting. In this mode, you can select receiving frequencies by rotating the dial.

- **Switching between bands**

Pressing the  or  key will select the band.

## 6-2 Setting the Channel Step Frequency

A channel step refers to the interval between the frequencies which have been assigned to radio communications and broadcasts. Although the typical steps have been programmed in the DJ-X11, you can change the steps as necessary. For the procedure, refer to “Changing the Channel Step” (P. 58).

## 6-3 1 MHz UP/DOWN Operation

- **Changing the frequency of the main band in larger increments**

In VFO mode, select the main band, hold down the [FUNC] key and rotate the upper main dial. The frequency increases or decreases in units of 1 MHz.

- **Changing the frequency of the sub band in larger increments**

In VFO mode, select the sub band, hold down the [FUNC] key and rotate the upper sub dial. The frequency increases or decreases in units of 1 MHz.



**MEMO**

- The 1 MHz UP/DOWN operation increases or decreases the frequency regardless of the frequency range of the band.
- When the [FUNC] key is held down but the dial is not rotated for approximately one second, the Key-lock will be activated.
- When using the 1 MHz UP/DOWN operation, the display may sometimes jump to an unexpected frequency due to the channel step setting.

## 6-4 Setting Frequencies through Direct Input

The frequency can be directly input with the key pad.

Example 1: To input 145.000 MHz

Press the keys and then press the key.

Example 2: To input 0.702 MHz

Press the keys and then press the key.

Example 3: To input 1270.680 MHz

Press the keys and then press the key.

Example 4: To input 145.550 MHz

Press the keys and then press the key.

If you press an incorrect key, press the [FUNC] key to repeat the input from the beginning.



MEMO

- The beep during the input can be silenced. (P. 92)
- The frequencies which can be input for the sub band are limited. (P. 33)

## 6-5 Setting frequencies in Preset mode

**1** While in VFO mode, press the key once. The DJ-X11 is set to the Preset mode and the reception mode is displayed on the LCD.

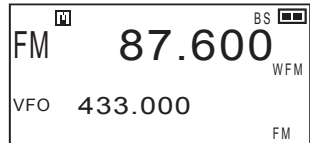

**2** Press the key to select a desired band.

Every time the key is pressed, the band is changed in the order shown on the right.

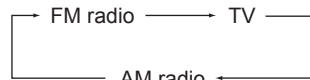

**3** Rotate the main dial to select a frequency (or a TV channel).



MEMO

- The preset mode cannot be used with the sub band.

## 6-6 Receiving Operation



- Communication is not broadcasting. In most cases, communication is established when necessary using minimum facilities. It is extremely rare for communication to send radio signals frequently. Unlike radio broadcasting, it is not always easy to receive communication.
- The noise you hear while no signal is received (called background noise or white noise) may vary in condition, volume and sound quality depending on the modulation mode, aerial condition, frequency and so on, and this is not a malfunction.
- The radio signal strength and sound quality which can be received may be affected by various factors including the power supply to be used (AC adapter or battery), locations/conditions (presence of electric appliances such as fluorescent lamps or TV, wooden or steel bar reinforced building, region, whether the user is standing still or walking, etc.) and aerial condition, and this is not a malfunction.
- The supplied whip antenna is designed mainly to receive the V/UHF bands outdoors. To efficiently receive signals indoors which are in the long wave, medium wave, short wave, and 1000 MHz or higher UHF bands, install a commercially-available external antenna suitable for the respective frequencies.
- In an area affected by an intense electric field, such as an area close to mountains where many transmission towers or stations exist, you may experience signal overlapping such as when airplane communication overlaps a radio broadcast sound. This, however, is not a malfunction. Using the Attenuator or RF Gain function described later can reduce such interference and interruption.
- The DJ-X11 receives radio signals over a very wide range, however, when it is compared with radios or receivers specifically designed for a certain frequency range, its sensitivity, sound quality and volume may be inferior within that range. This is because their circuit designs are completely different; this is not a malfunction.
- The preset mode cannot be used with the sub band.
- When a certain combination of frequencies is set for the main and sub bands, one or both bands may experience reception failure, interference or unstable operation. This is due to the attempt to receive signals with two bands simultaneously and is unavoidable.

Please read and understand the above cautions before reading the rest of this manual. The operation of some functions may be difficult to understand unless you actually see the operation while receiving signals. It is recommended to practice operation by receiving actual AM/FM broadcasts.



- 1** Set the mode to operate and tune to the frequency. When signals are received on the selected frequency, “**BUSY**” and the reception level are displayed on the LCD and the received sound is heard. Moreover, the RX lamp illuminates in green.

- The range of receivable frequencies is as follows:

Receivable frequencies for the main band  
0.05 to 1299.99995 MHz

Receivable frequencies for the sub band

144 MHz band: 118 to 170.995 MHz

430 MHz band: 336 to 469.995 MHz



**MEMO**

- The range of receivable frequencies for the sub band can be extended, although this is not useful in actual practice because the sensitivity degrades significantly.

- 1** Hold down the [FUNC] key (approx. one second) to activate the Key-lock. (P. 63)

- 2** Press the       keys.

This allows the sub band to receive frequencies between 225.000 and 335.995 MHz.



**CAUTION**

- These frequencies between 225 and 336 MHz of the sub band, the lower frequencies in particular, are out of the specifications which Alinco recognizes for practical use. Problems may occur frequently due to poor receiving sensitivity and filter characteristics depending on the use environment, such as the signals which can be received with the main band cannot be received, or undesired radio signals are received. Even so, the expansion of the receivable frequency range of the sub band has been offered because reception is sometimes possible with strong radio signals or in a favorable radio signal environment. Note that this frequency range is not the rating specification guaranteed by Alinco and it cannot be improved or modified due to the circuit design.



**CAUTION**

- From now on, when you continue operations by following the instructions in this manual, the receiver operation may be disabled or the resulting display may be different from those shown in the manual. In such a case, reset the receiver to return the settings to the default. Refer to (P. 101).

It is recommended to read through the manual once to understand the overall functions and operations first, and then set the items in Set mode in detail.

# 7. Memory Mode

Memory mode allows you to pre-program frequently-used frequencies and settings into the receiver's memory so that you can quickly call up a desired setting. A "bank" is a location where frequencies are categorized for ease of use. Each frequency programmed to a bank is called a "channel". In an address book of a mobile phone, a "bank" corresponds to a "group starting with A", a "group starting with B", and so on. A "memory channel" corresponds to individual names.

## 7-1 Memory Types and Usage

The DJ-X11 has the following six types of memory banks.

Bank for normal memory channels	Contains channels which are used in normal operation in Memory mode. A total of 1200 frequency channels can be programmed. You can program your favorite frequencies to call them up easily.
Bank for programmed scan channels	Contains channels which are used for the programmed scan to find signals within a specified frequency range. Up to 50 pairs of frequency ranges (upper and lower limits) can be programmed.
Bank for dual band channels	This bank is used to call up the channels of both the main and sub bands simultaneously. Up to 100 pairs can be programmed as dual band channels.
Bank for priority channels	This bank is used for the Priority Monitoring function (prioritized reception). Up to 100 frequency channels can be programmed.
Bank for skip-search channels	Frequencies programmed to this bank are skipped during VFO and programmed scans. Up to 100 frequency channels can be programmed. This is useful for programming constant noise signals or unwanted broadcasts.
Bank for Bug Detector channels	Frequencies which are often used by bugging devices have been programmed to this bank. These channels cannot be programmed to or deleted from the memory. Only memory skip operation can be set.



**CAUTION**

- You cannot program duplicate frequencies to the bank for skip-search channels. If you try to do so, an error beep will sound.
- The noise frequencies which the receiver itself constantly emits are programmed in skip-search channels before shipment.

## 7-2 Programming a Memory Channel

This section describes how to program a memory channel with the DJ-X11.



**MEMO**

- For easy understanding, it is recommended to read this page once and then actually operate the receiver according to the programming example shown on (P. 37).

### **1 In VFO mode, set the desired frequency and the Tone Squelch function in advance.**

You can program the following items in a memory channel.

- Frequency
- Tone frequency
- DCS code
- Modulation mode (reception mode)
- Tone squelch/Reverse tone squelch/DCS
- Memory name
- Skip setting

### **2 Press the [FUNC] key.**

### **3 Refer to the table on the next page and rotate the dial to select the bank and memory channel to be used for programming.**

To program the frequency for the main band, use the main dial to select the bank and memory channel.

To program the frequency for the sub band, use the sub dial to select the bank and memory channel.

If a memory channel which has already been programmed is selected, "MR" is displayed on the LCD.

- Rotate the lower dial to change the bank type and rotate the upper dial to change the memory channel.

- Bank

The relationship between the bank and the memory is as follows:

Number	Banks for normal memory channels (This setting may change before shipment due to the change in memory data.)
PRG	Bank for programmed scan channels
DUAL	Bank for dual band channels. A pair of frequencies for the main and sub bands are programmed in one memory channel.
PRIO	Bank for priority channels
PASS	Bank for skip-search channels
BUG	Bank for Bug Detector channels (Cannot be edited.)

Select an appropriate bank according to the usage.

- Memory channel

The number of programmable memory channels differs depending on the bank type as follow

Number	000 to ...
PRG	0A to 49B
DUAL	000 to 099
PRIO	000 to 099
PASS	000 to 099

Select an appropriate memory channel according to the usage.

#### 4 Press the key to complete the programming.

After the programming is complete, the receiver returns to the previous operation mode.



MEMO

- By default, it is not possible to overwrite a memory channel to which data has been programmed.
- To delete or edit memory channel data, first disable or temporarily cancel the "Write-protect (memory protection) function" (P. 91) and then continue the procedure.
- By using the free software which can be downloaded from the Alinco website (<http://www.alinco.com/>) and the optionally available PC connection cable (ERW-7/ERW-8), you can divide these memory banks as desired, into up to 50 banks x 1200 memory channels. This operation cannot be performed with the key pad of the receiver only.



- “DUAL” can be selected only when the dual-band display is selected.
- The bank for programmed scan channels requires programming of two frequencies to channels \*\*A and \*\*B.

Example: Assume that a frequency of 145.020 MHz is programmed to channel 01A, and a frequency of 146.100 MHz is programmed to channel 01B. The programmed scan operation scans the range between 145.020 MHz programmed to channel 01A and 146.100 MHz programmed to channel 01B.

### Example: When programming a frequency of 145.000 MHz to channel 002 of bank 15 with the main band

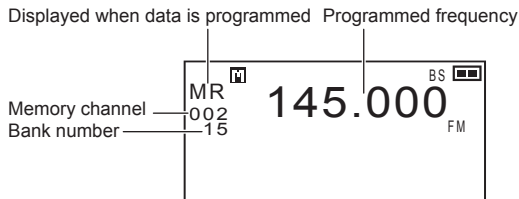

- (1) In VFO mode, operate the main band and tune to frequency 145.000 MHz.
- (2) Press the [FUNC] key.
- (3) Rotate the lower main dial and select bank “15”.
- (4) Rotate the upper main dial and select memory channel “002”.
- (5) Press the  key to complete the programming.

### • Sample of the memory channel programming display



- It is not possible to expand the memory.
- You can set letters, symbols, numbers, Japanese character and pictographs instead of the frequency numbers to represent the programmed memory channels. For details, refer to “Memory Naming Function” (P. 41).
- Memory channels can be called up by using either the dial or key pad.

## 7-3 Calling Up a Memory Channel



- 1** Press the  key to switch to Memory mode.
- 2** Press the  or  key to select the memory bank to call up.
- 3** Rotate the dial to select the memory channel.





CAUTION

- When you call up the data in the bank for dual band channels, you cannot switch between the main and sub bands.
- When a frequency which is out of the range of the sub band is programmed in the memory channel with the main band, that frequency cannot be displayed with the sub band.  
Refer to (P. 33) in “Receiving Operation” for the range of the receivable frequencies for the sub band.
- This function cannot be used when the memory channel programming is not valid.

**Example: Use the main band to call up 145.000 MHz programmed in channel 002 of bank 15.**

- (1) Set the main band as the band to operate and press the  key to switch to Memory mode.
  - (2) Press the  key to select bank “15”.
  - (3) Rotate the upper main dial and select channel “002”.
- The memory channel programmed in the memory is displayed.

## 7-4 Deleting a Memory Channel

- 1** Set the “Write-protect (memory protection) function” (P. 91) to “Prohibited” or “fail-safe”.
- 2** Press the  key to switch to Memory mode.
- 3** Select the memory channel to delete.
- 4** Press the [FUNC] key to display **F** on the LCD.
- 5** Press the  key, and a confirmation notice is displayed as shown on the right.
- 6** Press the  key to delete the channel from the memory. Pressing another key cancels the operation.

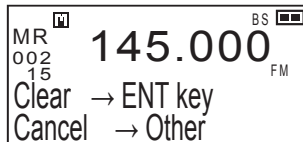





- Once data is deleted, it cannot be restored. Ensure that you do not delete necessary data by mistake.
- To prevent important data from being deleted accidentally, be sure to reactivate the “Write-protect (memory protection) function” (P. 91) after deleting data. When you set the Write-protect function to “fail-safe”, the setting will be automatically reset to “Accepted” after the receiver is turned OFF and then turned ON again.

## 7-5 Editing a Memory Channel



The data in a memory channel can be moved to a memory channel in another bank.

- 1** Press the  key to switch to Memory mode.
- 2** Select the memory channel to move data.
- 3** Press the [FUNC] key.
- 4** Press the  key.
- 5** Rotate the dial to select the destination bank and memory channel.  
When you select a memory channel which has already been programmed with data, "MR" is displayed on the LCD.
- 6** Press the  key.  
Pressing the [FUNC] key cancels the operation.





- To overwrite and program a memory channel, you need to set the “Write-protect (memory protection) function” (P. 91) to “Prohibited” or “fail-safe” in advance.

## 7-6 Quick Memory

This function is used to quickly call up memory channels which are frequently used in Memory mode. Quick memory items can be programmed to the  to  keys.

### 7-6-1 Programming a memory channel to the quick memory

- 1** Press the  key to switch to Memory mode.
- 2** Call up the memory channel to be programmed to the quick memory.
- 3** Hold down one of the  to  keys on the key pad (approx. one second).  
"Registered" is displayed on the LCD.



MEMO

- When you edit a memory channel which has been programmed to the quick memory, the change is reflected in the quick memory.
- To cancel the quick memory programming, perform the operation in Steps **1** and **3** above. "Released" is displayed on the LCD.

### 7-6-2 Calling up a memory channel from the quick memory

- 1** Press one of the  to  keys on the key pad.
- 2** Press the  key.



MEMO

- The quick memory data can be called up in any operation mode.

## 7-7 Memory Skip Function

The Memory Skip function enables you to skip a specified memory channel and continue scanning during the Memory Scan operation. Since scanning always stops at memory channels emitting broadcasts or an idle signal, skipping such channels ensures efficient scanning.

- 1** Press the  key to switch to Memory mode.
- 2** Select the memory channel to skip.



### 3 Press the key.

The "MR" display on the left of the LCD changes to "SKIP", indicating that the Memory Skip function is set to the channel.

To deactivate the Memory Skip function, select the memory channel and repeat the steps above.

The "SKIP" display on the LCD changes to "MR" and the function is deactivated.

## 7-8 Memory Naming Function

You can name the memory channel programmed in Memory mode by using up to 8 numbers, letters, Japanese character, symbols and pictographs in total.

You can search memory channels more easily by registering call signs and broadcasting stations with names.

### • Registering a memory name

1 Press the  key to switch to Memory mode.

2 Press the [FUNC] key to display **F** on the LCD.

3 Press the  key to switch to Memory Naming mode.  
"Edit name" is displayed on the LCD.

4 Enter characters with the key pad.

The keys on the key pad are assigned to specific characters.

For details, refer to "List of characters assigned to the key pad" (P. 43 to P. 47).

5 To move the character entry cursor, rotate the lower dial.

6 To clear characters one at a time, press the  key.  
To clear all characters, hold down the  key (approx. one second).



MEMO

- Some of icons that appear in normal display mode won't appear or may be displayed in different way. For example, "SKIP" won't appear but skip channels are indicated without a hyphen between the bank and channel number in the memory naming mode.







### • Entering a memory name

The keys on the key pad are assigned to characters. (P. 43 to P. 47)

When you press the keys on the key pad one at a time, the corresponding characters are displayed in the order the keys were pressed.

When you press the key on the key pad and then rotate the upper dial, the characters assigned to the key are displayed in succession. Rotating the dial further displays kanji characters.

Entry example: To enter "DJ - X11 

- 1 Press the  key and rotate the upper dial to select "D".
- 2 Press the  key and rotate the upper dial to select "J".
- 3 Press the  key and rotate the upper dial to select "-".
- 4 Press the  key and rotate the upper dial to select "X".
- 5 Press the  key once and rotate the lower dial to move the character entry cursor.
- 6 Press the  key once and rotate the lower dial to move the character entry cursor.
- 7 Press the  key and rotate the dial to select "1".
- 8 Move the cursor to the right by rotating the lower right dial.
- 9 Press the [FUNC] key to finish the setting.

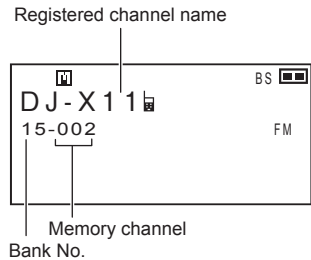

#### MEMO

- Even after the memory name is registered, you can use the frequency display. Refer to "Memory name display setting" (P. 92).
- You can create your own pictographs using the utility software.
- The flashing character is not yet registered. Be sure to move the cursor to the right so that it stop flashing.
- It is recommended to use Alinco's DJ-X11 free utility software downloadable from [alinco.com](http://alinco.com) site for easier and faster naming operation. One of ERW-4C/7/8 optional PC-connection cables is necessary to operate with the software.



• List of characters assigned to the key pad (kanji)





<p><b>WILD</b> 1</p>	<p>啞哇阿哀愛挨始逢葵茜穉惡握渥旭葦芦鏗梓庄幹扱宛姐虻鮎餉綾鮎或粟裕安庵按暗案闇鞍杏以伊位依偉困夷委威尉耐恣慰易椅為畏異移維緯胃萎衣謂違遺医并亥域育郁磯一壹溢逸稻茨芋鰓允印咽員因咽引飲淫胤蔭院陰隱韻吋右宇烏羽迂雨卯鷄鷄丑碓臼渦噓唄鬱蔚繖姥厥浦瓜閏樽云運雲荏餌馥嘗嬰影映曳朶永泳洩瑛盈穎穎英衛詠詠液疫益馱悅謁越閱樓厭凹園堰奄宴延忍掩援沿演炎焰煙燕猿綠艷苑園遠鉛鴛塢於汚甥凹央奧往応押旺橫歐毆王翁襖鶯鴉黃岡冲荻億屋憶臆桶牡乙俺卸恩溫德音</p>
<p><b>GAIN</b> 2ABC</p>	<p>下化佻何伽伽佳加可嘉夏嫁家寡科暇果架歌河火珂禍禾稼箇花苛茄荷華菓蝦課嘩貨迦過霞蚊俄哦我牙画臥芽蛾賀雅餓駕介会解回塊壞迴快怪悔恢懷戒拐魁晦械海灰界皆給芥蟹開階貝凱効外咳害崖慨概涯碍蓋街該鎚骸湮蟿蛙垣柿蛎鈎劃嚇各廓攬攪格核殼獲確穫覺角棘較郭閣隔革学岳樂額頸掛笠樞樞梃鯁瀉渴喝恰括活濁滑葛褐轄日鯉叶柁樺鞞株兜鼈蒲釜鎌嘴鴨栢茅萱粥刈刈瓦乾侃冠寒刊勘勸卷喚堪姦完官寬干幹患感慣憾換敢柑桓棺款歎汗漢潤濯環甘監看竿管簡緩缶翰肝艦莞觀諫貫還鑑問閑閑陷韓館館丸含岸巖玩癌眼岩斲贗雁頑顏願企伎危喜器基奇嬉奇岐希幾忌揮机旗既期棋棄機婦毅氣汽畿祈季稀紀徽規記貴起軌輝飢騎鬼龜偽儀妓宜戲技擬欺犧疑祇義蟻誼議掬鞠鞠吉吃喫桔橘詰砧杵黍却客脚虐逆丘久仇休及吸宮弓急救朽求汲泣灸灸球究窮笈級糾給旧午去居巨拒拋拳渠虛許距鋸漁禦魚亨亨京供俠僑兇競共凶協匡卿叫喬境峡強疆怯恐恭挾挾教橋況狂狹矯胸齋興蕎鄉鏡響響驚仰凝堯曉業局曲極玉桐杆僅勤均巾錦斤欣欽琴禁禽筋緊芹菌衿襟謹近金吟銀九俱句区狗玖矩苦軀驅駟駒具愚虞喰空偶寓遇隅串櫛釧屑屈掘窟沓靴轡窪熊隈采栗綠桑鐵勳君薰訓群軍郡卦袞袞係傾刑兕啓圭珪型契形徑患慶慧憩揭携敬景桂溪畦稽系經繼繫野荊蚩計詣警輕頸鷄芸迎鯨劇戟擊激隙桁傑欠決潔穴結血訣月件俛倦健兼券劒喧圈堅嫌建憲懸拳捲檢權牽犬獻研硯絹梟肩見謙賢軒遣鍵險頭驗驗元原廠幻弦減源玄現絃絃言諺限乎個古呼固姑孤己庫弧戶故枯湖狐糊袴股胡菰虎誇跨鈷雇顧鼓五互伍午吳吾娛後御悟梧櫛瑚碁語誤護翻乞鯉交侯倏候倖光公公効勾厚口向后喉坑垢好孔孝宏工巧巷幸庑庚康弘恒慌抗拘控攻昂晃更杭校梗構江洪浩港溝甲皇硬稿糠紅紉絞綱耕考肯肱腔膏航荒行衡講貢購郊醅鈺鈺鋼閣降頂香高鴻剛劫号合壕拷濠豪轟趨克刻告国殺鵠黑獄漉腰甌忽惚骨狍込此頃今因坤壘婚恨懇昏昆根梱混痕紺良瑰</p>

7

ATT  
3DEF

些佐又峻嵯左差查沙瑳砂詐鎖袞坐座挫債催再最哉塞妻宰彩才採  
 裁歲濟災采犀碎砦祭齋細菜裁載際劑在材罪財冴坂阪堺榭肴咲崎  
 埼碕鷗作削昨搾昨朔柵窄策索錯銜鮭笹匙冊刷察搯撮擦札殺薩雉  
 臯鯖捌鏑鮫皿晒三傘參山慘撒散棧燦珊產算纂蚕讚贊酸餐斬暫殘  
 仕仔伺使刺司史嗣四士始姊姿子屍市師志思指支孜斯施旨枝止死  
 氏獅祉私糸紙紫肢脂至視詞詩試詔資賜雌飼齒事似侍兒字寺慈  
 持時次滋治爾璽痔磁示而耳自蒔薛汐鹿式識鳴竺軸穴零七叱執失  
 嫉室悉濕漆疾質寔郛篠恂柴芝屢蕊縞舍写射捨赦斜煮社紗者謝車  
 遮蛇邪借勺尺杓灼爵酌穠錫若寂弱惹主取守手朱殊狩珠種腫趣酒  
 首儒受呪寿授樹綬需囚収周宗就州修愁拾洲秀秋終繚習臬舟菟眾  
 襲讐蹴輻迥酉酬集醜什住充十從戎柔汁汶獸縱重銃叔夙宿淑祝縮  
 肅塾熟出術述俊峻舜駿准循旬栢殉淳準潤盾純巡遵醇順処  
 初所暑曙渚庶緒署書書諸諸助叙女序徐恕鋤除傷償勝匠升召哨商  
 唱嘗獎妾媚宵將小少尚庄床廠彰承抄招掌捷昇昌昭晶松梢樺樵沼  
 消涉湘燒焦照症省硝礁祥称章笑粧紹肖萑蔣蕉衝裳訟証詔詳象賞  
 齏鉦鍾鐘障鞞上丈丞乘冗刺城場壤孃常情擾条杖淨状量穰蒸讓釀  
 錠囑埴飾拭植殖燭織職色舐食蝕辱尻伸信侵唇娠寢審心慎振新晋  
 森榛浸深中疹真神秦紳臣苾薪親診身辛進針震人仁刃塵壬尋甚尽  
 腎訊迅陣鞞筭諷須酢囟厨逗吹垂帥推水炊睡粹翠衰遂醉錘錘随瑞  
 髓崇嵩数枢趨雛据杉椁菅頗雀裾澄摺寸世瀨畝是凄制勢姓征性成  
 政整星晴棲栖正清牲生盛精聖声製西誠誓請逝醒青靜齐稅脆隻席  
 惜戚斥昔析石積籍績脊責赤跡蹟碩切拙接撰折設窃節說雪絕舌蟬  
 仙先千占宣專尖川戰扇撰栓柗泉浅洗染潜煎煽旋穿箭線織羨腺舛  
 船薦詮賤踐選遷錢銑閃鮮前善漸然全禪繕膳糗嚼塑岨措曾曾楚狙  
 疏疎礎祖租粗素組蘇訴阻溯鼠僧創双叢倉喪壯奏爽宋屠匠惣想搜  
 掃插搔操早曹巢槍槽漕燥争瘦相窓糟綜綜聡草莊葬蒼藻裝走送遭  
 鎗霜騷像增憎臧蔵贈造促側則即息捉束測足速俗厲賊族統卒袖其  
 掬存孫尊損村遜

<p><b>MODE</b> 4GHI</p>	<p>他多太汰詔唾墮妥恠打柁舵橈陀馱駢体堆对耐岱帶待怠態戴替泰                  滯胎腿苔袋貸退逮隊黛鯛代台大第醒題鷹瀧卓啄宅托挾拓沢澤                  琢託鐸濁諾苜胤蛸只叩但達辰奪脫異豎辻棚谷狸鱧樽誰丹单嘆坦                  担探旦歎淡湛炭短端筵綻耽胆蛋誕鍛团壇彈断暖檀段男談值知地                  弛恥智池痴稚置致蚰遲馳築畜竹筑蓄逐秩窒茶嫡着中仲宙忠抽昼                  柱注虫衷註耐鑄駐樗豬猪苧著貯丁兆凋喋寵帖帳巾帛張彫徵懲挑                  暢朝潮牒町眺聽脹腸蝶調謀超跳跳長頂烏勅抄直朕沈沈質鎮陳津                  墜椎槌追鎚痛通塚拇楸楓佃漬柘辻蔦綴鏑椿潰坪壺媯袖爪吊釣鶴                  亭低停偵剃貞呈堤定帝底庭廷弟悌抵挺提梯汀碇禎程締艇訂諦諦                  遁邸鄭釘鼎泥摘擢敵滴的笛適適溺哲徹撤迭鈇典填天展店添纏                  甜貼軫顛屯伝殿澱田電兔吐堵塗妬屠徒斗杜渡登菟賄途都鍍砥砺                  努度土奴奴倒党冬凍刀唐塔塘套宕島嶋悼投搭東桃桃棟盜淘湯湯                  灯燈当痘痔等答筒糖統到董蕩藤討膳豆踏迹透鐙陶頭騰鬪動動同                  堂導懂撞同瞳童胴萄道銅峠鴉匿得德洸特督禿篤毒独誦柝椽凸突                  椴届鳶苫酉西瀨噸屯惇敦沌豚遁頓吞曇鈍</p>
<p><b>TONE</b> 5JKL</p>	<p>奈那内乍卮雍謎灘捺鍋樞馴繩躡南楠軟難汝二尼忒迹勾脈肉虹廿                  日乳入如尿菲任妊忍認濡襦祢寧葱猫熱年念捻撚燃粘乃迺之堇囊                  惱濃納能腦膿農硯蚤</p>
<p><b>LINK</b> 6MNO</p>	<p>巴把播霸杷波派琶破婆罵芭馬俳庠排敗杯盃牌背肺輩配倍培媒                  梅煤煤須買壳賠陪這蠅秤矧荻伯剥博拍柏泊白箔粕舶簿迫曝漠爆                  縛莫駁麥函箱砢箬肇箬櫨幡肌焮畠八鉢澆癸醜髮伐罰拔筏閱鳩嘶                  塙蛤隼伴判半反叛帆搬斑板汜汎版犯班畔繁般藩販範采煩頌飯挽                  晚番盤磐蕃蠻匪卑否妃庇彼悲扉批披斐比泌疲皮碑秘緋罷肥被誹                  費避非飛樋箴備尾微枇毘琵琶眉美鼻柎稗匹疋髭彥膝菱肘弼必畢筆                  逼桧姪媛紐百謬佞彪標水漂瓢票表評豹廟描病秒苗錨鉸蒜蛭鱒品                  彬斌浜瀕貧賓頻敏瓶不付埠夫婦富富布府怖扶敷斧普浮父符腐膚                  芙譜負賦赴阜附侮撫武舞葡蕪部封楓風葦葦伏副復幅服福腹覆覆                  淵弗舛沸仏物紂分吻噴墳憤扮焚奮粉糞紛雰文聞丙併兵摒幣平弊                  柄並蔽閉陸米頁僻壁癖碧別瞥蔑篋偏變片篇編辺返遍便勉婉弁鞭                  保鋪鋪圃捕步甫補輔穗募墓慕戍暮母簿菩做俸包呆報奉宝峰峯崩                  庖抱捧放方朋法泡烹砲縫胞芳萌蓬蜂褒訪豐邦鋒飽鳳鵬乏亡傍剖                  坊妨帽忘忙房暴望某棒冒紡肪膨謀貌貿鉞防吠頰北佬卜墨撲朴牧                  睦穆鈎勃沒殆堀幌奔本翻凡盆</p>

	<p>摩磨魔麻埋昧枚每哩禎幕膜枕鮪枉鱒榘亦俟又抹末沫迄促繭磨          万慢滿漫蔓味未魅已箕岬密蜜湊蓑稔脈妙耗民眠務夢無牟矛霧鷓          棕婿娘冥名命明盟迷銘鳴姪牝滅免棉綿緬面麵摸模茂妄孟毛猛盲          網耗蒙儲木默目空勿餅尤戾粉貰問悶紋門匆</p>
	<p>也冶夜爺耶野弥矢厄役約葉訊躍靖柳藪鏹愉愈油癒諭輸唯佑優勇          友宥幽悠憂揖有柚湧涌猶猷由祐裕誘遊邑郵雄融夕予余与譽輿預          傭幼妖容庸揚搖擁曜楊樣洋溶熔用窯羊耀葉蓉要謠踊遙陽養慾抑          欲沃浴翌翼淀</p>
	<p>理璃痢裏裡里離陸律率立律掠略劉流溜琉留疏粒隆竜龍侶慮旅虜          了亮僚兩凌寮料梁涼獺療瞭稜糧良諒遼量陵領力綠倫厘林淋磷琳          臨輪隣鱗麟璫望淚累類令伶例冷勵嶺伶玲礼苓鈴隸零靈麗齡曆歷          列劣烈裂廉恋憐漣煉簾練聯蓮連鍊呂魯櫓炬賂路露勞婁廊弄朗樓          榔浪漏牢狼篲老聾蟬郎六麓祿肋録論</p>
	<p>倭和話歪賄脇惑杵鷺互巨鱷詫藁蕨椀湾碗腕</p>

### <About kanji characters>

The DJ-X11 is programmed with all of the first class kanji characters of JIS standard.

## 8. Functions Assigned to the Key Pad

With the DJ-X11, the function shown above each key has been assigned to that key. To set the assigned function, press the [FUNC] key to display **F** on the LCD and then press the corresponding key.

### 8-1 Shortcut Function

You can assign any Set mode menu items to the [MONI] key and  key respectively.

By assigning frequently used functions, you can change the setting quickly.

- 1** Press the [FUNC] key to display **F** on the LCD.
- 2** Press the [MONI] key or  key to call up the assigned function.
- 3** Follow the procedure for the assigned Set mode operation.  
For the procedure for registering the function, refer to "Assigning a function to the WILD key" or "Assigning a function to the MONI key" (P. 86).



### 8-2 Receiving Sensitivity (RF Gain) Adjustment and Attenuator Function

When there is interference with the receiving signal due to a station emitting strong signals on a nearby channel or when an FM broadcast is heard in the aviation radio band, use these functions to deliberately decrease the receiving sensitivity so that such interference is reduced and the target signal becomes more audible. Since the RF gain can be adjusted for the main and sub bands individually, it is suitable for the case when the main and sub bands are receiving different bands (such as the combination of the main band receiving VHF fire radio and the sub band receiving UHF simple business radio). The Attenuator function sets both bands in the same way, so that it is suitable for example when two frequencies of VHF aviation radio are received simultaneously.



- Adjusting the receiving sensitivity

**1** Press the [FUNC] key to display **F** on the LCD.

**2** Press the  key to display “Main band gain” (for the main band) on the LCD. Pressing the  key again displays “Sub band gain” (for the sub band).

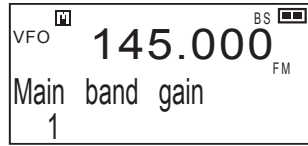

**3** Rotate the upper dial to adjust the sensitivity in 10 levels from “1” to “10”.

The receiving sensitivity of this function can be set between "1" (highest) and "10" (lowest).

- Setting the Attenuator function

**1** Press the [FUNC] key to display **F** on the LCD.

**2** Press the  key to display “Attenuator” on the LCD.

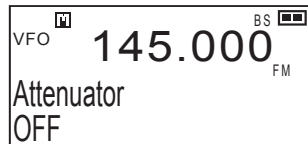

**3** Rotate the upper dial to adjust the setting in three levels of “OFF”, “Low”, and “High”.

When "Low" or "High" is selected, "ATL" or "ATH" illuminates respectively.



CAUTION

- The attenuation level of the Attenuator function varies depending on the received frequency.
- The receiving sensitivity adjustment of the DJ-X11 cannot “increase the sensitivity” such as when using a preamplifier.

## 8-3 Switching the Modulation Mode

Select the modulation mode to use to receive signals manually.

- 1** Tune to the frequency you want to receive in advance.
- 2** Press the [FUNC] key to display **F** on the LCD.
- 3** Press the  key to display “Modulation mode” on the LCD.
- 4** Rotate the upper dial to switch the modulation mode.

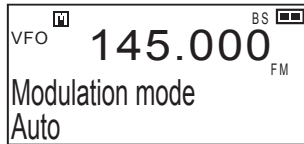

The modulation modes for the main band are switched as follows:

→ Auto ↔ FM ↔ WFM ↔ AM ↔ USB ↔ LSB ↔ CW ←

The modulation modes for the sub band are switched as follows:

→ Auto ↔ FM ↔ AM ←



- The modulation modes which can be selected for the sub band are AM and FM only.
- Since the SSB/CW reception of the DJ-X11 uses a simple circuit, the performance against interference or suppression is inferior to communication receivers, however, this is not a malfunction. Sometimes USB can be demodulated with LSB depending on the signal strength.
- The filter is common to CW and SSB and does not support the Narrow mode.
- To receive frequencies lower than the short wave band where SSB and CW are frequently used, it is especially important to install an appropriate external antenna.

## 8-4 Setting the Tone Squelch/DCS

To put the receiver on standby to receive signals from specific stations, use the Tone Squelch (CTCSS) or DCS function.



- You cannot set both Tone Squelch and DCS functions to one band.

- Press the [FUNC] key to display **F** on the LCD.
- Every time the  key is pressed, the functions are switched in the following order:  
CTCSS → CTCSS reverse → DCS → OFF

### 8-4-1 Tone Squelch function

There are two Tone Squelch function types.

- Tone Squelch "TSQ":  
Selective reception can be performed based on the decoder function setting.
- Reverse Tone Squelch "SQ":  
The squelch closes when the received tone frequency matches the selected frequency based on the decoder function setting. This function is mainly used to receive taxi radio.

- Press the [FUNC] key to display **F** on the LCD.
- Press the  key several times to select "CTCSS" or "CTCSS reverse".

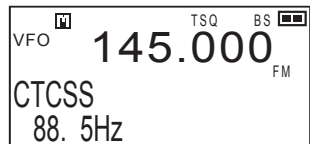

- 3 Rotate the upper dial to select the tone squelch frequency from the 39 frequencies listed below.**



(Unit: Hz)

67.0	69.3	71.9	74.4	77.0	79.7	82.5	85.4
88.5	91.5	94.8	97.4	100.0	103.5	107.2	110.9
114.8	118.8	123.0	127.3	131.8	136.5	141.3	146.2
151.4	156.7	162.2	167.9	173.8	179.9	186.2	192.8
203.5	210.7	218.1	225.7	233.6	241.8	250.3	

**<List of tone squelch frequencies>**

Press the [FUNC] key to finish the setting.

When the received tone frequency matches with the selected frequency, the "TSQ" or "SQ" mark is displayed in reverse.

- 4 To cancel the Tone Squelch function, press the [FUNC] key to display  on the LCD. Press the  key several times to select "OFF" and then press the [FUNC] key. The Tone Squelch function is deactivated.**



- You should adjust the normal squelch level properly in advance even when the Tone Squelch function is used. If the normal squelch remains open, the Tone Squelch operation will require a longer time.

## 8-4-2 DCS function

This function allows selective reception according to a similar principle to the Tone Squelch function.

You can select from 104 DCS codes.

**1** Press the [FUNC] key to display **F** on the LCD.

**2** Press the  key several times to select "DCS".

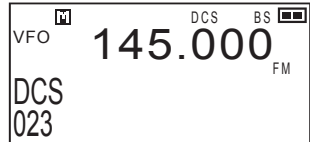

**3** Rotate the upper dial to select the DCS code from the 104 codes listed below.

023	025	026	031	032	036	043	047
051	053	054	065	071	072	073	074
114	115	116	122	125	131	132	134
143	145	152	155	156	162	165	172
174	205	212	223	225	226	243	244
245	246	251	252	255	261	263	265
266	271	274	306	311	315	325	331
332	343	346	351	356	364	365	371
411	412	413	423	431	432	445	446
452	454	455	462	464	465	466	503
506	516	523	526	532	546	565	606
612	624	627	631	632	654	662	664
703	712	723	731	732	734	743	754

<List of DCS codes>

Press the [FUNC] key to finish the setting.

When the received DCS code matches with the selected code, the "DCS" mark is displayed in reverse.

**4** To cancel the DCS function, press the [FUNC] key to display **F** on the LCD. Press the  key several times to select "OFF" and then press the [FUNC] key. The DCS function is deactivated.



- You should adjust the normal squelch level properly in advance even when the DCS function is used. If the normal squelch remains open, the Tone Squelch operation will require a longer time.

## 8-5 Bank Link Setting Function

During the memory scan, the banks to be scanned can be grouped as desired. You can set 10 groups and another one group for the Bug Detector function. These groups correspond to keys **SHIFT** **0** through **AUDIO** **9** and **SUB**. (Pressing the **SUB** key selects Group B which can be linked with the bank for Bug Detector channels.)

### • Setting the bank link

**1** Press the **[FUNC]** key to display **F** on the LCD.

**2** Press the **LINK** **0** **MNO** key.

**3** Press one of the **SHIFT** **0** to **AUDIO** **9** and **SUB** keys to select the group No. to set.

**4** Rotate the dial to select the bank No. and press the **STEP** **ENT** key to set the link to "ON". The group is now registered.

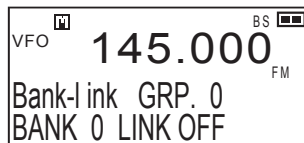

Pressing the **STEP** **ENT** key again sets the link to "OFF" and cancels the registration.

- To confirm the details of a registered group, select the group and rotate the lower dial. The link status of each bank is displayed.



## 8-6 Priority Monitoring Function



- When no data is programmed to the priority channel, the Priority Monitoring function is disabled. Refer to (P.35) for details.

The Priority Monitoring function monitors two channels alternately to improve reception efficiency. After receiving signals from the active channel in VFO mode for 5 seconds (\*1), the DJ-X11 receives the signals from the selected priority channel for 0.5 second to see if there are any signals being sent. This function is useful when you set your favorite channel as the main channel, and set a channel of interest as the priority channel.

This function can be used for the main and sub bands individually.

- 1 Press the [FUNC] key to display **F** on the LCD.**
- 2 Hold down the  key and rotate the upper dial to select a priority channel.**
- 3 Releasing the  key activates the Priority Monitoring function.**

When the signals from the priority channel are received, a beep sounds. The reception continues until the signals sent from the priority channel stop. (\*2)

- 4 Press the [FUNC] or  key to stop the Priority Monitoring function.**
    - Scanning is disabled while the Priority Monitoring function is ON.
    - Since the DJ-X11 monitors the priority channel every 5 seconds (\*1), the audio of the main channel is momentarily interrupted at this interval. Although this phenomenon is conspicuous in particular for constant signals such as a broadcast, this is not a receiver failure.
- \*1 The interval at which the priority channel is monitored can be changed in Set mode via the "Priority Monitoring interval setting" (P. 89)
- \*2 The time for which priority channel signal reception is stopped can be changed in Set mode via the "Priority Monitoring duration setting" (P. 90).

## 8-7 Received Sound Quality Adjustment Function

This function changes the quality of the received sound. Set this function according to your preference.

The audibility may vary depending on the reception mode (modulation mode).

**1** Press the [FUNC] key to display **F** on the LCD.

**2** Press the  key. “Audio high cut” is displayed on the LCD. Pressing the key again displays “Audio low cut”.

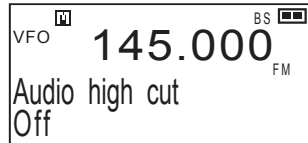

**3** Rotate the upper dial to select “ON” or “OFF” for each range to change the sound quality.

**4** Press the [FUNC] key to finish the setting.



MEMO

- This function is not effective for Wide FM.
- Cutting the low-range signals while the tone squelch is used reduces the booming noise in the tone which can be heard by people with excellent hearing. This combination is particularly effective for high frequency tones. The tone squelch still operates properly.



## 8-8 Frequency Shift Function

The Frequency Shift function switches from the frequency currently being received to another frequency with the press of a single key. For example, communication with a repeater (relay) uses sending (uplink) and receiving (downlink) frequencies separately. The Frequency Shift function allows you to receive signals of both frequencies alternately by switching between them with a press of a key.

### 8-8-1 Setting the Frequency Shift function

**1** Press the [FUNC] key to display **F** on the LCD.

**2** Press the  key to select the direction of the frequency shift.

Every time you press the  key, the display changes in the order shown on the right.

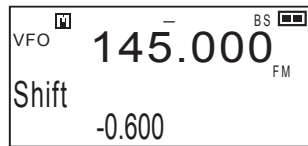

**3** Rotate the dial to set the frequency tuned by the shift.

You can change the frequency in steps of 1MHz by rotating the dial while holding down the [FUNC] key.

**4** Press the [FUNC] key to complete the setting.



MEMO

- Normally, communication via a repeater can be received by tuning to the downlink frequency (the frequency which the repeater uses to send the received signal).
  - When this function is used, the base-station signals are relatively strong and can be received easily.
  - The mobile-station signals, however, are not so strong and can be heard only within the coverage area.
- This function is commonly described as a “reverse-monitor” in amateur-radio equipment.

### 8-8-2 Using the function

Press the  key to receive the shifted frequency.

Press the  key again to receive the original frequency.



CAUTION

- To cancel the Frequency Shift function, press the [FUNC] key to display **F** on the LCD, hold down the  key until “OFF” appears, and then press the [FUNC] key again.

## 8-9 Changing the Channel Step

The channel step is the interval between the frequencies which have been assigned to radio communications and broadcasts.

The default channel step can be changed.

The channel step can be changed to the one of the following units:

- **Selectable channel steps**

Auto, 50Hz, 100Hz, 1kHz, 5kHz, 6.25kHz, 8.33kHz, 10kHz, 12.5kHz, 15kHz, 20kHz, 25kHz, 30kHz, 50kHz, 100kHz, 125kHz, 150kHz, 200kHz, 500kHz, 1MHz

Some channel steps cannot be selected depending on the frequency to be received.



MEMO

- Use 50 Hz for SSB or CW mode.

- For default band settings and frequency range, refer to P. 110.

# 8

**1** Select the band to change the channel step.

**2** Press the [FUNC] key to display **F** on the LCD.

**3** Press the **STEP** key to display "Step" on the LCD.

The LCD displays the contents as shown on the right.

When the main band is selected

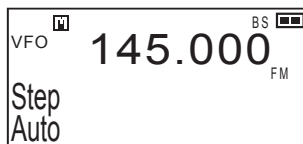

When the sub band is selected

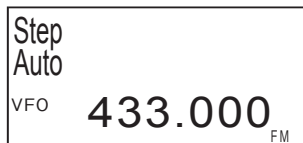

**4** Rotate the upper dial to select "Auto" or the specific channel step.

## 8-10 Channel Scope Function

The Channel Scope function receives the signals of the displayed frequency and shows the levels of the signal reception in the nearby channels simultaneously. You can use this function in VFO and Memory modes to check the usage of several channels at a glance.

Normal display

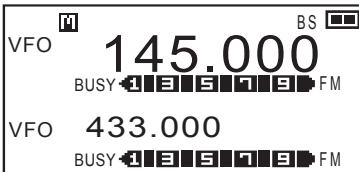

The level of the signal reception for the displayed frequency is indicated as a horizontal bar.

When Channel Scope is ON

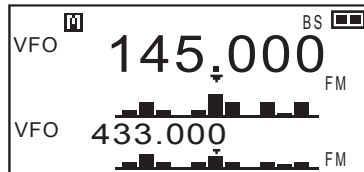

The levels of the signal reception for 11 frequencies are indicated as vertical bars with the center channel (displayed frequency) in the center (under ▼).

### • Channel Scope operation

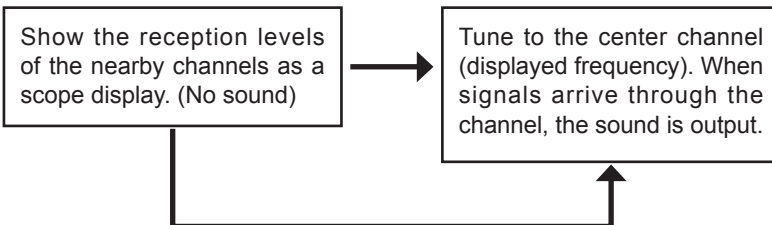

- When no signal arrives through the center channel, the 11 frequencies are automatically scanned and the scope display is updated continuously.
- When signals arrive through the center channel, they are received according to the scan mode setting (P. 88). (The scope display is not updated.)
- When the timer scan is set, the received sound of the center channel is interrupted momentarily because the display of the nearby channels is updated in synchronization with the setting even during the reception of the center channel signals. When the busy scan is set, the display of the nearby channels does not change during the reception of the center channel signals.
- When the periodic scan is set, the scope display is updated at constant intervals regardless of the presence/absence of the center channel signals. The received sound is interrupted momentarily while the display is updated.

- **Channel Scope operation when the Tone Squelch/DCS function is set (Reception of the center channel signals in Normal mode)**

When the Tone Squelch or DCS function is set, signals are stopped in the center channel. If the tone matches the selected value, the received sound is output.

- **Channel Scope types**

- (1) There are VFO Channel Scope and Memory Channel Scope depending on the mode when the operation is started.
- (2) Dual-band and mono-band  
When the sub band is used with the mono-band display, the received sound is not interrupted regardless of the scan setting.

### 8-10-1 VFO Channel Scope

The signal reception levels are displayed for each channel step frequency with the center channel in the center.

- 1 In VFO mode, select the band to display the scope.**

- 2 Press the  key.**

The VFO Channel Scope is displayed.

- 3 Rotate the dial to select the center channel.**

The center channel changes upward or downward by one channel for each step. The scope display shifts to the right or left accordingly.

- **VFO scope display indications**

Example: When the channel step for the main band is set to 20 kHz

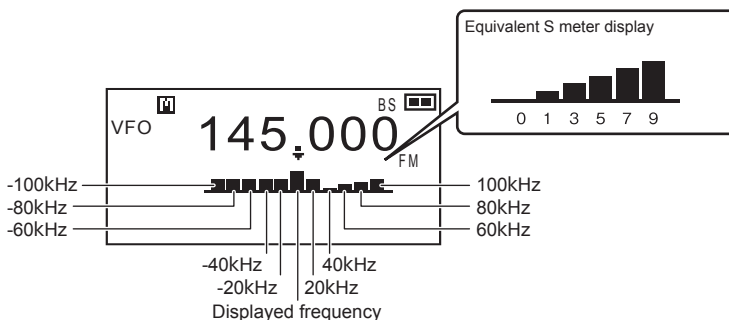

## 8-10-2 Memory Channel Scope

The reception levels are displayed for the frequencies of neighboring programmed memory channels with the frequency of the displayed memory channel in the center.



- The Channel Scope function ignores empty memory channels.
- When there is no memory channel which can be used as a scope target, the Channel Scope function does not start.

**1** In Memory mode, select the bank for which to display a scope display.

**2** Press the  key.



The memory channel scope operation starts. The signals of the displayed memory channel (center channel) are received and the reception levels of the nearby programmed memory channels are indicated in the scope display.

**3** Rotate the dial to select the center channel.

The center channel changes upward or downward to the next target memory channel. The scope display shifts to the right or left accordingly.



**MEMO**

- By pressing the [FUNC] key to display **F** and then pressing the  key, you can change the reception operation for the center channel as follows.
  - Normal mode: When signals are received through the center channel, the sound is output. The reception time follows the "Scan mode setting" (P. 88). The Channel Scope operation always starts in Normal mode.
  - Display mode: Like other channels, the reception of the center channel signals is indicated with the level display only and no sound is output even when signals are received.
- You can switch the band to operate by pressing the  or  keys. The bands are switched and the Channel Scope operation remains active. When the dual-band display is set, the Channel Scope operation can be conducted simultaneously for both bands.

## 8-11 Copying the Memory Channel Data into VFO Mode

You can copy the frequency of a memory channel into VFO mode. This function is useful when you want to receive a frequency slightly different from that of a memory channel or when you edit a memory channel.

- 1** In Memory mode, select a memory channel to copy its data into VFO mode.
- 2** Press the [FUNC] key to display **F** on the LCD.
- 3** Press the  key; the frequency of the memory channel is copied into VFO mode.

When the copy is complete, the mode changes to VFO mode.

## 8-12 F Tuning Function

This function allows reception of unknown radio signals by detecting a strong radio signal and quickly tuning to its frequency. The F Tuning function can be used in two modes: F COUNT (Frequency counter) and F TUNE (Strong signal-priority tuning).

- In F COUNT mode, when an extremely strong signal is detected among the received signals, its frequency is displayed in real time.
- In F TUNE mode, priority is given to detecting an extremely strong signal among the received signals. A normal scan is then performed around the frequency of the signal to catch the target signal more quickly and accurately.

### • Setting the F Tuning function

- 1** Press the [FUNC] key to display **F** on the LCD.
- 2** Press the  key several times to select “F COUNT” or “F TUNE”.
- 3** When “F TUNE” is selected, the receiver automatically changes to VFO mode when it detects a frequency, allowing you to hear the sound.

F COUNT

- 4** Press the [FUNC] key to finish the setting.



- The operating frequency for F COUNT and F TUNE is within the range of 50 MHz to 1299.99995 MHz.
- This function may not work depending on the frequency condition, such as when there are radio signals or noise stronger than the target radio signal.
- The resolution of F COUNT is 5 kHz.
- The sensitivity may vary depending on the frequency.

# 9. Useful Functions

## 9-1 Key-lock Function

The Key-lock function prevents accidental operation of the keys and dials while the receiver is being used or carried.

Two types of locking are available: Quick Lock which can be activated easily, and Normal Lock which is more complicated to unlock.

### 9-1-1 Key-lock procedure

- **Quick Lock**

Hold down the [FUNC] key (approx. one second) to switch the function ON/OFF.

While the Key-lock is active, the  mark appears on the LCD.

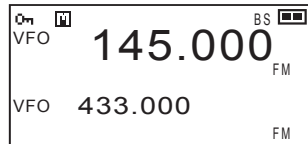

- **Normal Lock**

Hold down the  key and press the left dial three times to switch the function ON/OFF.

While the Key-lock is active, the  mark appears on the LCD.

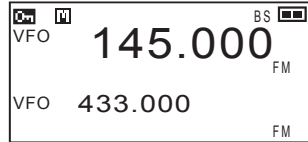

CAUTION

- To release the Key-lock function, use the same method you used to activate the lock. There is no other way to release the lock.
- If the  key is held down but the dial is not pressed for about 1 second, the mono-band display is switched to the dual-band display and vice versa.

### 9-1-2 Operations available while the Key-lock is active

- **Volume adjustment:**

You can adjust the volume level by rotating the lower dial.

- **Squelch adjustment:**

You can adjust the squelch level by holding down the dial and rotating it. For the key settings which are available while the Key-lock is active, refer to "Key-lock mode setting" (P. 83).

## 9-2 Scanning Function

The Scan function automatically changes the frequencies and searches for signals being sent.

The following scan types are available.

VFO scan	In VFO mode, the scan searches all frequencies within the selected band by using the tuning step specified in advance.
Preset scan	The scan searches the frequencies within the band specified in Preset mode.
Memory scan	In memory mode, the scan searches for only frequencies which have been programmed in the memory.
Programmed scan	The scan searches a range of frequencies between upper and lower limits which can be set by the user in advance.







MEMO

- The programmable items shown in P.35 with ✳ do not affect their functions while programmed scanning, but setting such as tone-squelch and modulation mode must be completed in VFO mode, and VFO parameters are always respected for programmed scan.

### • Operations common to all scan types

- Scanning stops when any one of the [FUNC],  keys is pressed.
- The scanning direction can be changed by rotating the dial during scanning.
- When the Monitor function is used, scanning is suspended to open the squelch temporarily. Releasing the Monitor function resumes scanning.
- Scanning starts in the direction of the last scan. (Programmed scan, however, starts scanning from ✳✳ A to ✳✳ b.)
- You can specify conditions to resume scanning. For the setting procedure, refer to "Scan mode setting" (P. 88).



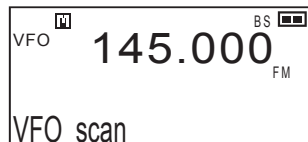

## 9-3 VFO Scan

- 1 Press the  key to switch to VFO mode.
- 2 Hold down the  key and rotate the upper dial to select "VFO scan".
- 3 Release the  key to start scanning.  
During scanning, the decimal point of the displayed frequency flashes.
- 4 Press the [FUNC] or  key to stop scanning.





## 9-4 Preset Scan

- 1 Press the  key to switch to Preset mode.
- 2 Press the  key to select the band.
- 3 Press the  key to start scanning.  
During scanning, the decimal point of the displayed frequency flashes.
- 4 Press the [FUNC] or  key to stop scanning.

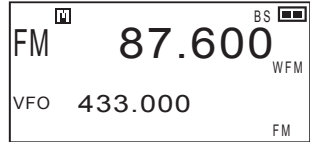

## 9-5 Memory scan



In Memory mode, either a specified bank or all banks are scanned. The memory scan offers the following three types of scanning methods.

Single bank scan	This scans only through a specified bank.
Group scan	This scans only a group of previously selected banks.
All-bank scan	This scans all available banks which are previously programmed.



MEMO



- Banks other than those for normal memory channels cannot be scanned.
- By using the utility software to expand the bank, the all-bank scan can be expanded to scan between banks 0 and 49.
- The group scan cannot be used unless the Bank Link setting (P. 54) is completed.

- 1 Press the  key to switch to Memory mode.
- 2 Hold down the  key and rotate the upper dial to select the scan type.

The following types are available for the memory scan.

- Single bank scan
- Group scan
- All-bank scan

When the single-bank scan is selected, the current bank will be scanned.

- 3 Release the  key to start scanning.  
During scanning, the decimal point of the displayed frequency flashes.
- 4 Press the [FUNC] or  key to stop scanning.

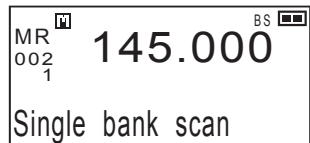

## 9-6 Programmed Scan

The Programmed scan searches a range of frequencies specified by upper and lower limits. The specified upper and lower frequencies are collectively referred to as a "programmed scan channel". The DJ-X11 can store up to 50 pairs of programmed scan channels. For more information, refer to "Programming a Memory Channel" (P. 35). Note that you need to program data in the bank for programmed scan channels in advance. If you do not do this, the following operation cannot be performed.

**1** Press the  key to switch to VFO mode.

**2** Hold down the  key and rotate the upper dial to select "Prg-Scan".

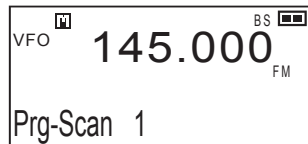

**3** Release the  key to start scanning.

During scanning, the decimal point of the displayed frequency flashes.

**4** Press the [FUNC] or  key to stop scanning.

## 9

## 9-7 Tone Scan

The Tone scan automatically detects a tone frequency in the received radio signals.

**1** In VFO mode, tune to the frequency to search for a tone frequency.

**2** Hold down the  key and rotate the upper dial to select "TONE scan".

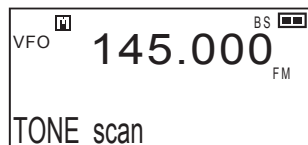

**3** Release the  key to start scanning.



Scanning starts. Tone frequencies being scanned for are displayed on the LCD one at a time.

When a matching tone is found, a beep sounds, " T S Q " and the tone frequency are displayed on the LCD, and scanning stops. Scanning continues when no tone frequency is found in the received radio signals.

**4** Press the [FUNC] or  key to stop scanning.

## 9-8 DCS Scan

The DCS scan automatically detects DCS codes in the received radio signals.

- 1 In VFO mode, tune to the frequency to search for a DCS code.
- 2 Hold down the  key and rotate the upper dial to select "DCS scan".
- 3 Release the  key to start scanning. Scanning starts. DCS codes being searched for are displayed on the LCD one at a time. When a matching DCS code is found, a beep sounds, "DCS" and the DCS code are displayed on the LCD, and scanning stops. Scanning continues when no DCS code is found in the received radio signals.
- 4 Press the [FUNC] or  key to stop scanning.

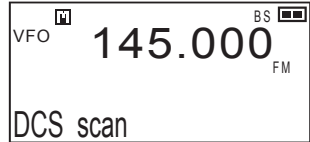

## 9-9 Sweep Scan

The Sweep scan scans frequencies during the Channel Scope operation and displays the reception levels. Even when scanning moves to the next channel, the reception level of the previous channel is displayed continuously. Like scanning, there are three types of Sweep scan: Band, Program and Memory.

- 1 While the Channel Scope operation is active, press the  key.**

The Sweep scan starts. The Sweep scan scans each channel step frequency one at a time. During the Sweep scan, the decimal point of the displayed frequency flashes. When signals at the displayed frequency are received, the reception will be handled according to the scan-resume condition.

- 2 Press the [FUNC] or  key to return to the Channel Scope operation.**

- Sweep scan level indication

Example: Sweep scan in the UP direction  
(when the channel step is set to 20 kHz)

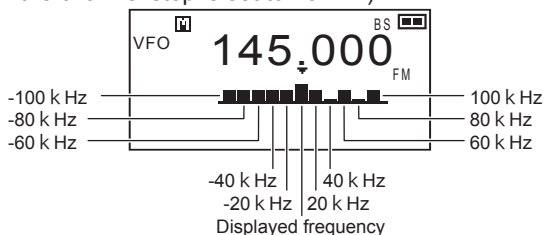

During the Sweep scan, reception levels are updated from the rightmost frequency, and the update display moves to the left one step at a time. For the DOWN direction, the update display moves in the reverse direction. The ▼ indicating the currently scanned frequency does not move.

## 9-10 Bug Detector Function

This function automatically scans frequencies possibly used by bugging devices (wireless microphones) to find such devices. When the receiver determines the presence of a bugging device, it provides notification via the display and an alarm. The DJ-X11 provides two modes for the function: Silent and Sound.

The default setting is a combination of both Silent and Sound modes. Refer to "Mode coupling setting of the Bug Detector function" (P. 71).

It is also possible to search for bugging devices by linking the user-programmed memory banks to the bank for Bug Detector channels.



MEMO

- In the Silent mode, you can set the search sensitivity of the Bug Detector function. Refer to "Sensitivity setting of the Bug Detector function" (P. 72).
- The Bug Detector function searches the memory channels in the bank linked with the bank for Bug Detector channels. Refer to "Bank Link Setting Function" (P. 54).



CAUTION

- When Voice Guidance is active, an announcement of "Detected" might be made even when non-bugging signals are received due to a malfunction caused by use environments or radio signal conditions. Note that this is an accessory function and should be used as a guide only.
- This function is designed based on a simple method and does not guarantee security and safety. Alinco does not guarantee against the failure of bugging device detection.
- Alinco does not provide any services such as discovering bugging devices or dealing with discovered devices.
- Alinco's Customer Service will not answer any general inquiries concerning bugging attempts other than the operation and operating procedure for this function.

### 9-10-1 Operating procedure in Silent mode

This mode provides an accurate search by producing the sound of received signals from the speaker and making a judgment based on the occurrence of a "howling" phenomenon which occurs if the signal is emitted from a bugging device. When you hear this ambient sound from the speaker, a bugging device may possibly be installed. (Be careful, as the sound may be loud.)

If you want to use the Silent mode alone, set the "Bug coupling" option for the mode coupling setting of the Bug Detector function to "OFF".

- 1 Hold down the right dial (approx. one second) to activate the Silent mode.**

Scanning starts automatically. No beep sounds during scanning. When the receiver determines the presence of a bugging device, it sounds an alarm and display a notice on the LCD as shown on the right.

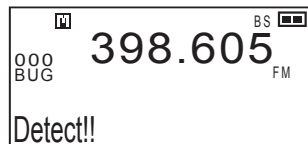

**2 Rotate the lower left dial to adjust the audio volume.**

Adjust the volume so that the DJ-X11 produces a howling noise (shrill sound) and then search for a bugging device. During the search, do not cover the opening of the speaker.

**3 Move around the DJ-X11 slowly.**

When you get closer to the bugging device, the howling noise becomes louder; when you move away from the bugging device, the howling noise becomes quieter. The function pauses when you press the  key.

Pressing the  key again resumes the search.

**4 To cancel the Bug Detector function, repeat the operation in Step 1.**

- Do not use earphones when using the Bug Detector function in this mode.
- The scanning may stop due to a malfunction caused by noise. If, however, a bugging device is actually present, you can judge this from the fact that the howling noise is always part of the ambient sound.

**9-10-2 Operating procedure in Sound mode**

This mode searches for a bugging device and determines an approximate distance to it by producing a sound from the DJ-X11 to make the bugging device emit the sound and measuring the time difference between when the DJ-X11 produces the sound and when it receives the signal of the sound. The advantage is that when the receiver determines the presence of a bugging device, it provides a notification of the approximate distance to the device with a sound and on the display. The receiver emits a continuous loud beep during the search.

If you want to use Sound mode alone, set the "Bug coupling" option for the mode coupling setting of the Bug Detector function to "OFF".

**1 Hold down the left dial (approx. one second) to activate the Sound mode.**



Scanning starts automatically.

The receiver emits a continuous beep during scanning.

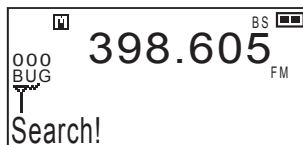
When no bugging device is found after the specified range is scanned for a certain period of time, "Stop" is displayed on the LCD and the search finishes.

**2 Move around the DJ-X11 slowly and search places where a bugging device might be installed.**

When the receiver determines the presence of a bugging device, it produces shorter beeps.

When the receiver gets closer to the bugging device, the intervals between the icons and beeps become shorter; when the receiver moves away from the bugging device, the intervals between the icons and beeps become longer. The function pauses when you press the  key. Pressing the  key again resumes the search.

### 3 To cancel the Bug Detector function, repeat the operation in Step 1.



- Do not use earphones when using the Bug Detector function in this mode.
- The effective detection distance of the Bug Detector function is about 1 to 5 m.
- The Bug Detector function is greatly affected by the ambient sound, the strength of the radio signals of the bugging device, and the sensitivity of the microphone. The function may not work properly or may not be usable depending on the surrounding environment (reverberation, etc.).
- When the DJ-X11 is moved quickly during the search, it may malfunction due to the Doppler effect.
- The function may not work properly depending on the relationship between the speaker orientation and the position of a bugging device.
- A malfunction may occur when the receiver receives radio signals including a sound similar to the tone it produces during the Sound mode operation.
- The scan time may become longer during the bugging device search when frequencies other than those often used by bugging devices have been linked with the bank for Bug Detector channels. (P. 54)

### 9-10-3 Mode coupling setting of the Bug Detector function

You can use the Bug Detector function with a combination of both Silent and Sound modes.

This setting cannot be selected while the Bug Detector function is active. When you set this setting to "ON" and start the function, the search starts in the mode specified in advance. When a suspicious signal is found, the search is automatically switched to the other mode.

**1** Press the [FUNC] key to display **F** on the LCD.

**2** Press the left dial to display "Bug coupling" on the LCD.

**3** Rotate the dial to select from "OFF", "ON" and "ON continue".

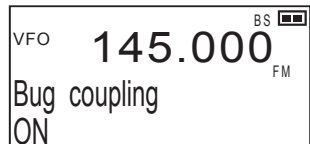

The default is "ON" which activates the coupling operation.

When "ON" is selected, the operation in the Silent mode automatically switches to the Sound mode after suspicious signals are detected, and vice versa. If no suspicious signal is detected, the search finishes without changing the mode.

When "ON continue" is selected, the search continues until any suspicious signals are detected.

## 9-10-4 Sensitivity setting of the Bug Detector function

You can set the detection sensitivity of the Silent mode of the Bug Detector function.

**1** Press the [FUNC] key to display **F** on the LCD.

**2** Press the right dial to display **“BUG sensitivity”** on the LCD.

The LCD displays the contents as shown on the right.

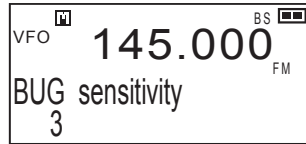

**3** Rotate the dial to select from **“1”** through **“5”**.

The default is set to 3.

The sensitivity of the Bug Detector function can be selected from "1" (lowest) through "5" (highest).



- The higher the sensitivity is set, the more frequently malfunctions will occur. Selecting a lower sensitivity can reduce malfunctions; however, the response becomes slow unless the receiver gets close to the bug-ging device.



# 10. Set Mode Configurations

You can improve the ease of use of the DJ-X11 by changing each function according to your preferences.

In the Set mode, the following items can be customized.

The items at the top of the list are called “menus”, and the setting items below are called “sub menus”.

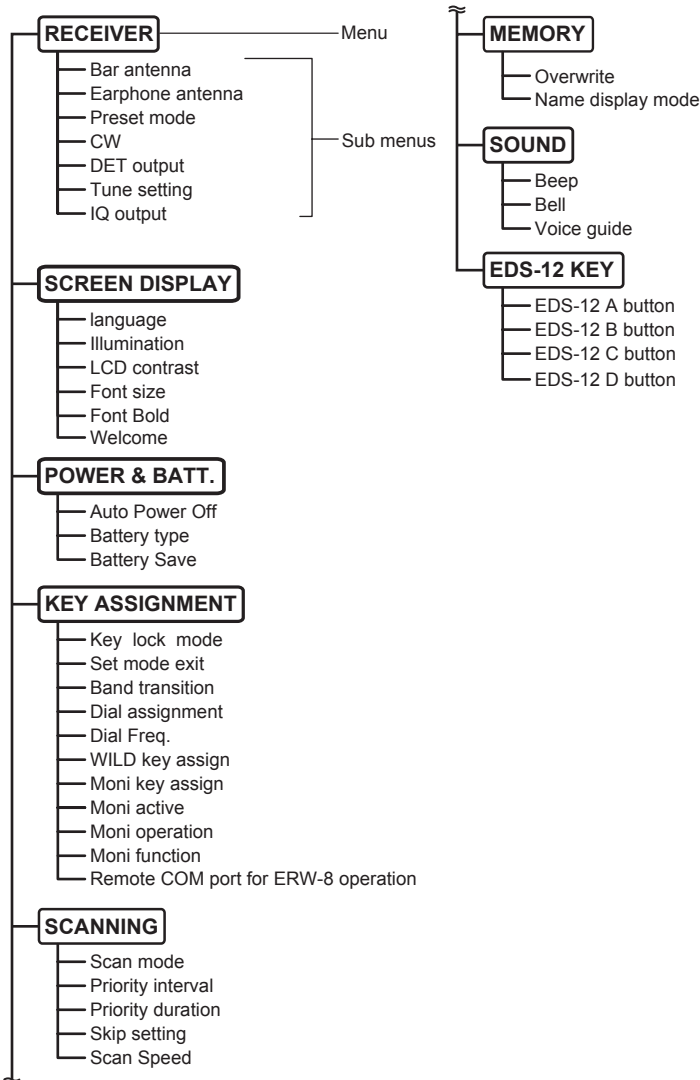

- Setting the Set mode items

- 1 Press the [FUNC] key to display **F** on the LCD.
- 2 Press the **SET CLR** key to switch to Set mode.
- 3 Rotate the upper dial to select the Set mode menu.
- 4 Press the **SET CLR** key to display the sub menu.
- 5 Rotate the upper dial to select the sub menu and rotate the lower dial to change the setting.
- 6 Press the [MONI] key to return to the Set mode menu selection screen.
- 7 Press the [FUNC] key to confirm the setting and exit the Set mode.



MEMO

- If you exit the set mode from sub-menu status, DJ-X11 resumes the last-operated sub menu.

## 10-1 Receiver Setting

Use this menu to set basic receiver options.

- 1 Select <RECEIVER> from the Set mode menu.
- 2 Press the **SET CLR** key to display the <RECEIVER> sub menu.

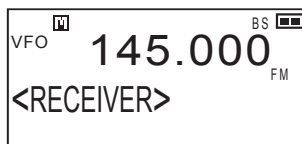

### 10-1-1 Bar antenna setting

Use this setting to switch the antenna used to receive signals in the AM radio band between the built-in bar antenna and an antenna connected to SMA port.

- 1 Rotate the upper dial to select “Bar antenna”.

The LCD displays the information as shown on the right.



- 2 Rotate the lower dial to select “ON” or “OFF”.

The built-in bar antenna is the default antenna used to receive AM radio band signals. To use the supplied whip antenna, you need to connect it to the antenna connector (SMA).



- The built-in bar antenna does not support shortwave broadcasts. You need to connect an appropriate antenna.

## 10-1-2 Earphone antenna setting

Use this setting to switch between the earphone antenna and the supplied whip antenna. When the earphone antenna is selected, you can receive signals even without connecting the supplied whip antenna because the earphone cord serves as an antenna.

### 1 Rotate the upper dial to select “Earphone antenna”.

The LCD displays the information as shown on the right.

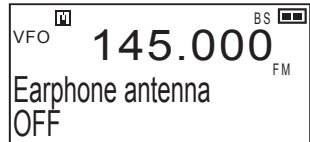

### 2 Rotate the lower dial to select “ON” or “OFF”.



MEMO

- Any commercially-available earphones can work as antenna to receive signals. (Both stereo and monaural antennae can be used.)
- When the earphone antenna is used, the received signals may be unstable depending on the condition of the earphone cord.
- Like the earphone antenna of a miniature transistor radio, this earphone antenna is not tuned to particular frequencies. As a result, it may properly receive only strong signals such as those of FM broadcasts or those sent from nearby sources.

## 10-1-3 Preset mode setting

Use this setting to prevent the Preset mode from being displayed as the operation mode.

### 1 Rotate the upper dial to select “Preset mode”.

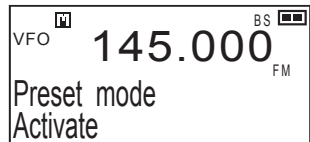

### 2 Rotate the lower dial to select “Activate” or “Deactivate”.

When “Deactivate” is selected, the Preset mode for the main band is not displayed when the  key is pressed.

## 10-1-4 CW setting

Use this setting to receive unmodulated continuous waves (Morse code signals).

- 1** Rotate the upper dial to select “CW”.
- 2** Rotate the lower dial to select “CWL” or “CWU”.

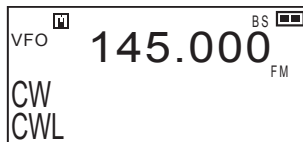

Select the setting with which you can hear more easily.

## 10-1-5 Detected signal output function

Some digital signals, such as 9600 bps high-speed packet communication of amateur radio, use modulation methods called FSK or GMSK. Consequently, these signals cannot be received properly with the DJ-X11 which receives filtered audio signals such as 1200 bps AFSK packets. In such a case, you may be able to receive data communication by inputting the signals to a dedicated connecting device (TNC, etc.) or a PC.



- The communication you want to receive may not be able to be decoded due to various conditions such as the compatibility of your device, software and PC, PC properties setting, and the signal receiving environment (noise or suppression). Note that Alinco does not offer any support other than testing “Weather or not your DJ-X11 meets our factory-standard specifications.” for this reason. Also, we cannot answer questions about the operating procedure of specific devices or software, or the type or environment settings of PCs.
- The received data will be output from the data signal output terminal of the 3-pole stereo mini-plug (P. 98).

- 1** Rotate the upper dial to select “DET out”.
- 2** Rotate the lower dial to select “Disable” or “enable”.

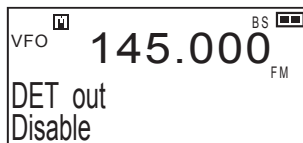

When "enable" is selected, the sound of the main band is not output.

## 10-1-6 F Tuning function operation setting

Use this setting to specify the frequency range used to scan signals detected by the F Tuning function. When “3” is selected, the scanning range is set to be wide to allow accurate tuning; however, extra time is required. Selecting “1” finishes scanning faster; however, the receiver may not tune to the target signal properly. The DJ-X11 provides a variable range because the required accuracy varies depending on the conditions such as the strength of the target signal.

- 1** Rotate the upper dial to select “Tune setting”.
- 2** Rotate the lower dial to select from “1” through “3”.

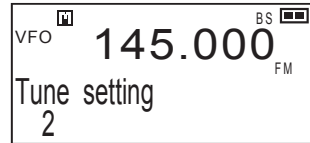

## 10-1-7 IQ signal output function

The DJ-X11 can output IQ signals from the earphone jack. By connecting the earphone jack and the PC's MIC/LINE IN input port with a commercially-available cable with ø3.5 mm stereo mini-plugs on both ends (the specification is the same as the cable used for the Cable-clone function described on P. 98), you can use SDR (Software Defined Radio) programs to enjoy reception on the PC using software available on the Internet. Since some of these programs offer functions which are unavailable with the DJ-X11 such as DSP (Digital Signal Processor), this function will expand the fun of "watching".



- Although Alinco has confirmed operation by testing several software programs developed by third-parties, some programs may not be usable due to various conditions such as the compatibility of your program and PC, PC properties setting, and the signal receiving environment (noise or suppression). Note that Alinco does not offer any support other than testing “Weather or not your DJ-X11 meets our factory-standard specifications.” for this reason. Moreover, we cannot answer questions about the operating procedure of specific software or the type or environment settings of PCs.

- 1 Rotate the upper dial to select "IQ output".

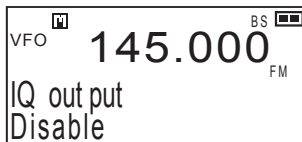

- 2 Rotate the lower dial to select "enable" or "Disable".

When "enable" is selected, the sound of both the main and sub bands is not output.

## 10-2 Screen Display Setting

Use this menu to set the screen display and illumination.

- 1 Select <SCREEN DISPLAY> from the Set mode menu.

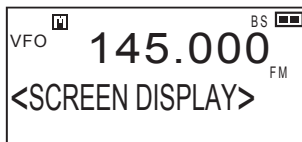

- 2 Press the  key to display the <SCREEN DISPLAY> sub menu.

### 10-2-1 Language setting

Use this setting to select the language display from English or Japanese.

- 1 Rotate the upper dial to select "language/言語"

The LCD displays the information as shown on the right.



- 2 Rotate the lower dial to select "English" or "日本語(Japanese)".



MEMO

- We intentionally left this feature to export models because many kanji characters are common with Chinese.

### 10-2-2 Illumination setting

Use this setting to specify whether to turn on or off the illumination for the LCD and keys as well as the illumination time.

The default is set to 5 seconds.

- 1 Rotate the upper dial to select "Illumination".

The LCD displays the information as shown on the right.

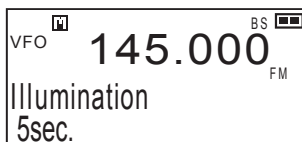

**2 Rotate the lower dial to select the illumination time.**

Rotating the dial switches to select the options as follows:

→ Always lit ↔ Disable all ↔ Turn out ↔ 5sec ↔ 10sec ↔ 15sec ↔ 20sec ↔ 25sec ↔ 30sec →

Always lit	The illumination is on all the time.
Disable all	The illumination and RX lamp go off.
Turn out	The illumination goes off.
5sec to 30sec	The illumination stays on for the specified time after operation.

**10-2-3 Contrast setting**

Use this setting to adjust the depth of the contrast displayed on the LCD. The default is set to 6.

**1 Rotate the upper dial to select “LCD contrast”.**

The LCD displays the information as shown on the right.

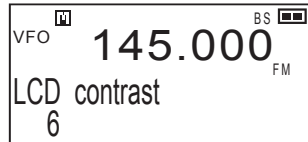
**2 Rotate the lower dial to select the contrast of the LCD from “1” through “10”.****10-2-4 Font size setting**

When the dual-display is selected, use this setting to switch the font size for the band which is not being operated.

**1 Rotate the upper dial to select “Font size”.**

The LCD displays the information as shown on the right.

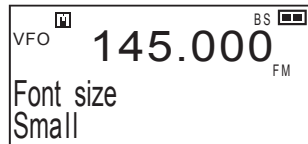
**2 Rotate the lower dial to select “Small” or “Large”.****10-2-5 Font style setting**

Use this setting to switch the font styles used for numbers.

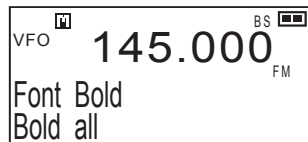
**1 Rotate the upper dial to select “Font Bold”.**

**2 Rotate the lower dial to select the number font option.**

Rotating the dial switches the options as follows:

→ Bold all ↔ Op. band bold ↔ Op. band thin ↔ Thin all ←

Bold all	All numbers are displayed in a bold font.
Op. band bold	The numbers of the band being operated are displayed in a bold font, and those of the other band are displayed in a thin font.
Op. band thin	The numbers of the band being operated are displayed in a thin font, and those of the other band are displayed in a bold font.
Thin all	All numbers are displayed in a thin font.

**10-2-6 Welcome screen setting**

Use this setting to display your favorite text on the welcome screen (the screen displayed immediately after the receiver is turned on).

**1 Rotate the upper dial to select “Welcome”.****2 Press the  key to go to the edit screen.****3 Rotate the lower left dial to select from “slide,” “disable” and “still” for the status of the text on the welcome screen.****4 Rotate the lower right dial and you can move the character entry cursor.****5 To enter characters, refer to the procedure to enter a memory name (P. 42).**

When no character is entered or “still” is selected, the normal welcome screen will be displayed.



## 10-3 Power and Battery Setting

Use this menu to set power-related options.

- 1** Select **<POWER & BATT.>** from the Set mode menu.
- 2** Press the  key to display the **<POWER & BATT.>** sub menu.

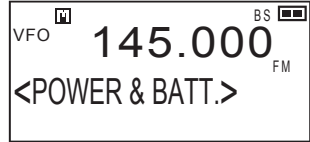

### 10-3-1 Auto power off setting

“Auto Power Off” is abbreviated to APO. Use this function to make a beeping sound and turn off the power automatically when the receiver is not operated for the specified period of time.

- 1** Rotate the upper dial to select “Auto Power Off”.

The LCD displays the information as shown on the right.

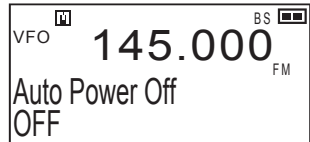

- 2** Rotate the lower dial to select the period of no operation before the power is turned off automatically.

Rotating the dial switches the options as follows:

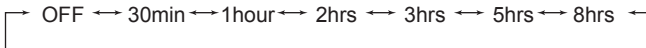

To turn on the receiver which was turned off by the APO function, hold down the POWER key.



**MEMO**

- The APO time is not extended while the receiver is only receiving signals. When any key is operated, the counter is reset and the timer restarts.
- When the APO is set and the receiver is not operated for the specified period of time, it is turned off even if the scan operation or Priority Monitoring function is active.

## 10-3-2 Battery setting

Use this setting to display the battery level icons correctly.

### 1 Rotate the upper dial to select “Battery type”.

The LCD displays the information as shown on the right.

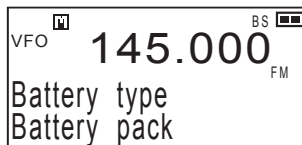

### 2 Rotate the lower dial to select “Battery pack” or “Dry Battery”.



- Icon display



When "Battery pack" is selected



When "Dry Battery" is selected



- When this setting is incorrect, the battery level (remaining power) is not displayed properly; however, operation continues normally.
- Be sure to use alkaline dry batteries.
- Commercially-available rechargeable AA batteries cannot be used. The use of such batteries is not covered by our warranty because it is highly possible that such use may lead to malfunction, breakdown, solution leakage, and heat generation.

## 10-3-3 Battery save function setting

Use this function to internally turn ON/OFF the power at short intervals to save the battery by reducing the current consumption during standby mode.

### 1 Rotate the upper dial to select “BS ratio”.

The LCD displays the information as shown on the right.

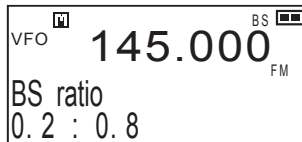

## 2 Rotate the lower dial to select the time while the power is ON and the time to save the battery.

When this function is set to ON, "BS" appears on the LCD.

Rotating the dial switches the options as follows:

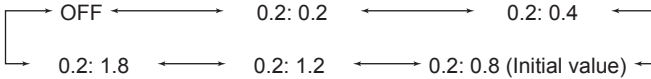

- This setting is factory-set to "0.2: 0.8". Under normal conditions, it is unnecessary to set this function to OFF. When you receive packet communication from amateur radio or data communication such as ACARS in aviation radio, set this function to OFF, even the squelch is opened.
- The battery save function is disabled while signals are received or scanned. If longer battery save time is selected, the beginning of a sound at signal reception may be lost.

## 10-4 Key Assignment Setting

Use this menu to set the key operation of the DJ-X11.

### 1 Select <KEY ASSIGNMENT> from the Set mode menu.

### 2 Press the key to display the <KEY ASSIGNMENT> sub menu.

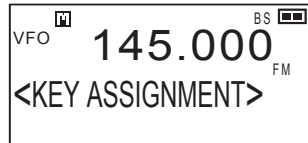

### 10-4-1 Key-lock mode setting

Use this setting to specify the keys and dials that will be locked by the Key-lock function.

### 1 Rotate the upper dial to select "Key lock mode".

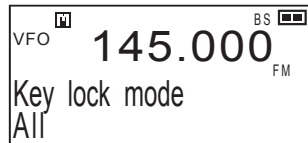

**2 Rotate the lower dial to select the key lock mode.**

Rotating the dial switches the options as follows:

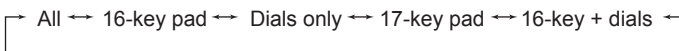

All	All operation will be locked.
16-key pad	The operation of the key pad will be locked except for the  key.
Dials only	The operation of the dials will be locked.*
17-key pad	The operation of the key pad will be locked.
16-key + dials	The operation of the key pad and dials will be locked except for the  key.

\* It is possible to operate the dials for volume and squelch adjustment and to press the [MONI] key.

**10-4-2 Set mode exit time setting**

Use this setting to specify the time to exit the Set mode automatically when no operation is performed. Available options are Manual and Auto (5 seconds to 5 minutes).

**1 Rotate the upper dial to select “Set mode exit”.**

The LCD displays the information as shown on the right.

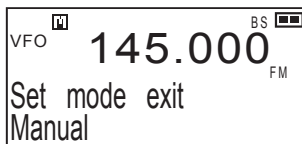

**2 Rotate the lower dial to select “Manual” or “Auto 5sec.” to “Auto 5min.”**

Manual (Initial value)	The Set mode continues until the [FUNC] key is pressed.
Auto 5sec.to Auto 5min.	The Set mode is terminated automatically when no key is operated for the specified time. Any change(s) in the setting(s) will be stored.

**10-4-3 Band transition setting**

Use this setting to determine the operation when the scanning or dial operation reaches the upper/lower end of the current band in VFO mode. Select whether to return to the other end of the same band or to move to the next band.

**1 Rotate the upper dial to select “Band transition”.**

The LCD displays the information as shown on the right.

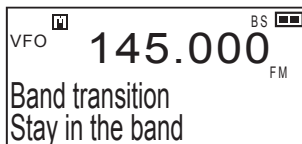

- 2 Rotate the lower dial to select “Stay in the band” or “Go to next band”.**

Stay in the band	Return to the other end of the same band.
Go to next band	Move to the next band.

### 10-4-4 Right/left dial function setting

Use this setting to swap the functions assigned to the right and left dials.

- 1 Rotate the upper dial to select “Dial assignment”.**

The LCD displays the information as shown on the right.

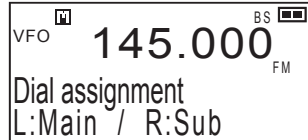

- 2 Rotate the lower dial to select “L:Main / R:Sub” or “L:Sub / R:Main”.**

### 10-4-5 Upper/lower dial function setting

Use this setting to swap the functions of the upper and lower dials.

- 1 Rotate the upper dial to select “Dial Freq.”**

The LCD displays the information as shown on the right.

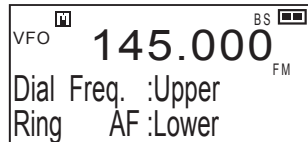

- 2 Rotate the lower dial to select the functions assigned to the upper and lower dials.**

Rotating the dial switches the options as follows:

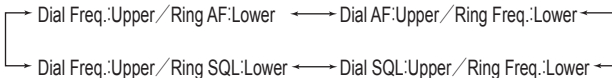

MEMO

- Either of volume or squelch which was not assigned here can be adjusted by pressing the dial.

### 10-4-6 Assigning a function to the WILD key

Use this setting to assign a desired menu item in the Set mode to the  key. Assign a frequently used menu so you can change the setting quickly.

- 1 Rotate the upper dial to select “WILD key assign”.**

The LCD displays the information as shown on the right.



- 2 Rotate the lower dial to select the function to be assigned to the  key.**

### 10-4-7 Assigning a function to the MONI key

Use this setting to assign a desired menu item in the Set mode to the [MONI] key. Assign a frequently used menu so you can change the setting quickly.

- 1 Rotate the upper dial to select “Moni key assign”.**

The LCD displays the information as shown on the right.

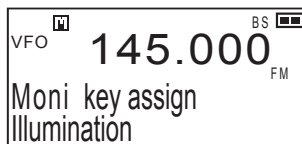

- 2 Rotate the lower dial to select the function assigned to the [MONI] key.**



- In an operating mode, press [FUNC] then [MONI] to recall the menu quickly.

### 10-4-8 Setting the band operated with the MONI key

Use this setting to specify the band to operate with Monitor function.

- 1 Rotate the upper dial to select “Moni active on”.**



- 2 Rotate the lower dial to select the band to be operated with the [MONI] key, function.**

Both bands	Both bands will be operated with the [MONI] key.
Main band only	The main band will be operated with the [MONI] key.
Sub band only	The sub band will be operated with the [MONI] key.
Operating band	The band currently being operated will be operated with the [MONI] key.

### 10-4-9 MONI key activation setting

Use this setting to specify how to operate the [MONI] key.

- 1 Rotate the upper dial to select “Moni operation”.**

The LCD displays the information as shown on the right.

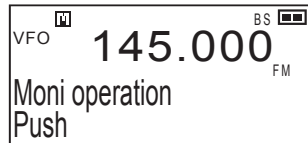

- 2 Rotate the lower dial to select “Push” or “Hold”.**

Push	The monitor or mute function is active only while the [MONI] key is pressed.
Hold	The monitor or mute function is active in the period between when the [MONI] key is first pressed and when it is pressed again.

### 10-4-10 MONI key setting

Use this setting to specify the monitoring or muting when the [MONI] key is pressed.

- 1 Rotate the upper dial to select “Moni function”.**

The LCD displays the information as shown on the right.

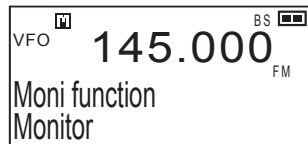

- 2 Rotate the lower dial to select “Monitor” or “Mute”.**

Monitor	When the [MONI] key is pressed, the squelch opens temporarily.
Mute	When the [MONI] key is pressed, sound is muted temporarily.

## 10-4-11 Remote COM port setting

The ERW-8 is an optional cable like the ERW-7 cable which is connected to the USB port of a PC to allow the use of memory editing software. Moreover, you can use the ERW-8 to control most functions of the DJ-X11 in real time, and charge the battery pack. Note that these operations require additional software. The ERW-8 should be used together with the EDC-174 charger. The following setting is necessary when you use the ERW-8.

- 1** Rotate the upper dial to select “Remote COM port”.
- 2** Rotate the lower dial to select “Enable” or “Disable”.

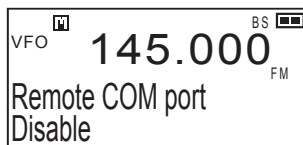

- It will take about eight hours to fully charge an empty battery pack using ERW-8.
- MEMO** • When “Enable” is selected, the ERW-7 cannot be used.
- ERW-7 can't real-time control the DJ-X11.

## 10-5 Scan Setting

Use this menu to set various scan functions included in the DJ-X11.

- 1** Select <SCANNING> from the Set mode menu.
- 2** Press the  key to display the <SCANNING> sub menu.

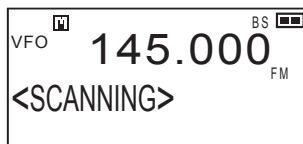

### 10-5-1 Scan mode setting

Use this setting to select the condition to resume scanning.

- 1** Rotate the upper dial to select “Scan mode”.

The LCD displays the information as shown on the right.

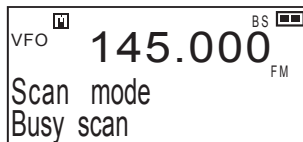



- 2 Rotate the lower dial to select “Busy scan”, “1sec. timer” to “25sec. timer”, or “1sec. elapse” to “5min. elapse”.**

Refer to the table below to select your desired mode.

Busy scan mode	After scanning stops, the DJ-X11 resumes scanning when there is no signal to receive.
Timer scan mode	After scanning stops, the DJ-X11 resumes scanning after the specified time even though it is still receiving signals. The timer period can be set within the range from 1 to 25 seconds (“1sec. timer” to “25sec. timer”).
Periodic scan mode	When the specified time elapses, the DJ-X11 automatically moves to the next channel regardless of the presence of signals. This is true even while the squelch is open. The elapsed time can be set within the range of 1 second to 5 minutes (“1sec. elapse” to “5min. elapse”).



**MEMO**

- The periodic scan is a scan mode to let the DJ-X11 automatically move to the next channel when the specified time elapses, regardless of the presence of signals. This is done even while the squelch is open. Consequently, this function is useful when you receive data communication such as ACARS (Aircraft Communication Addressing and Reporting System) and want to receive data from multiple channels at specific time intervals or to scan each channel by taking some time for monitoring.
- This function can be used in VFO, Preset, and Memory modes.

**10**

## 10-5-2 Priority Monitoring interval setting

Use this setting to specify the time to monitor the priority channel when the Priority Monitoring function is ON.

- 1 Rotate the upper dial to select “Prio. interval”.**

The LCD displays the information as shown on the right.

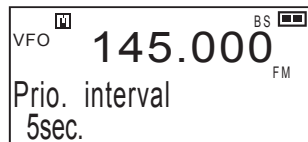

- 2 Rotate the lower dial to select the monitoring period between the range of 5 to 60 seconds.**

### 10-5-3 Priority Monitoring duration setting

Use this setting to specify the time to stop the reception of signals from the priority channel when the Priority Monitoring function is ON.

- 1 Rotate the upper dial to select “Prio. duration”.**

The LCD displays the information as shown on the right.

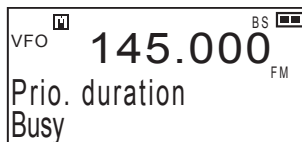

- 2 Rotate the lower dial to select “Busy” or “1sec.” to “25sec.”**

You can select the busy mode or the timer mode from 1 to 25 seconds.

### 10-5-4 Skip scan operation setting

You can select whether to skip the frequency programmed to the skip search memory channel and the memory channel specified for the skip operation (Valid) or not (Suspend).

The frequencies programmed to the skip-search memory channel are skipped during the VFO scan, programmed scan, and preset scan (excluding TV frequencies). The memory channels specified for skip operation are skipped during the memory scan.

During the memory scan, the frequencies programmed to the skip-search memory channel are not skipped.

- 1 Rotate the upper dial to select “Skip setting”.**

The LCD displays the information as shown on the right.



- 2 Rotate the lower dial to select “Valid” or “Suspend”.**

## 10-5-5 Scan speed setting

Use this setting to change the scan speed.

- 1 Rotate the upper dial to select “Scan Speed”.

The LCD displays the information as shown on the right.

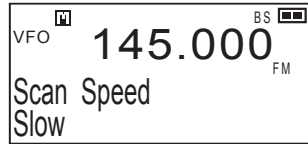

- 2 Rotate the lower dial to select from three levels: “Slow”, “Normal”, and “Fast”.

## 10-6 Memory Setting

Use this menu to set the memory functions.

- 1 Select <MEMORY> from the Set mode menu.

- 2 Press the  key to display the <MEMORY> sub menu.

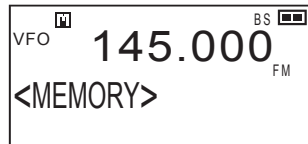

### 10-6-1 Write-protect (memory protection) function setting

Use this setting to enable editing (overwriting or deleting) for the channel data programmed for the Memory mode.

- 1 Rotate the upper dial to select “Overwrite”.

The LCD displays the information as shown on the right.

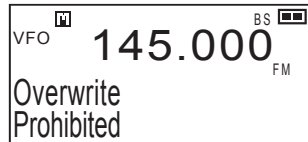

- 2 Rotate the lower dial to select the write-protect options.

Rotating the dial switches the options as follows:



Accepted	Write-protect is enabled. You cannot edit the data programmed in the memory.
Prohibited	Write-protect is disabled. You can edit the data programmed in the memory.
fail-safe	You can edit the data programmed in the memory. When the receiver is turned off once and turned on again, write-protect is enabled automatically.

To delete a memory channel, refer to the procedure shown in “Deleting a Memory Channel” (P. 38).

## 10-6-2 Memory name display setting

When memory names have been set, use this setting to select whether to display a memory name or frequency.

- 1 Rotate the upper dial to select “Name display”.**

The LCD displays the information as shown on the right.

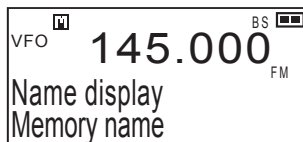

- 2 Rotate the lower dial to select “Memory name” or “Frequency”.**

Even when “Memory name” is selected, you can display a frequency temporarily by holding down the [MONI] key.

Also, when “Frequency” is selected, you can display a memory name temporarily by holding down the [MONI] key.

## 10-7 Sound Setting

Use this menu to set sound-related options.

- 1 Select <SOUND> from the Set mode menu.**

- 2 Press the  key to display the <SOUND> sub menu.**



### 10-7-1 Beep setting

Use this setting to enable or disable the beep sound produced when a key is pressed.

- 1 Rotate the upper dial to select “Beep”.**

The LCD displays the information as shown on the right.

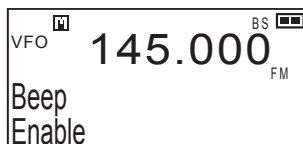

- 2 Rotate the lower dial to select “Enable” or “Disable”.**



- Selecting “Disable” also disables the alarm for the bell function.

CAUTION

## 10-7-2 Bell function setting

The Bell function uses a bell sound to provide notification when a signal is received.

- 1 Rotate the upper dial to select “Bell”.**

The LCD displays the information as shown on the right.

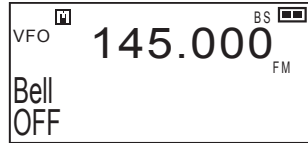

- 2 Rotate the lower dial to select “OFF”, “Main band only”, “Sub band only”, or “Either band”.**

When the Bell function is enabled,  appears on the LCD.

When a signal is received,  flashes and a bell sounds.

Since  continues flashing until the next key operation, this function can also be used as a "signal reception notification" when you leave the DJ-X11 momentarily.

OFF	A bell does not sound.
Main band only	A bell sounds when a signal is received on the main band.
Sub band only	A bell sounds when a signal is received on the sub band.
Either band	A bell sounds when a signal is received on either of the bands.

## 10-7-3 Voice Guidance function setting

This function reads the displayed frequency of the DJ-X11 or announces the result of the Bug Detector function in English.

### • Setting the Voice Guidance function

#### 1 Rotate the upper dial to select “Voice guide”.

The LCD displays the information as shown on the right.

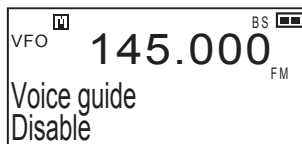

#### 2 Rotate the lower dial to select “Disable”, “key operation”, “Bugging mode”, or “Both”.

Disable	The voice guidance is disabled.
key operation	The voice guidance is activated for key pad operation. When the [MONI] key is pressed, the selected frequency is read aloud.
Bugging mode	When the mode coupling of the Bug Detector function is ON, the voice guidance announces whether a possible bugging device is found or not. (The voice guidance is disabled when "Bug coupling" (P. 71) is set to "OFF".)
Both	The voice guidance is activated for both key operation and the result of the mode-coupled Bug Detector function.



**MEMO**

- The sound volume can be changed. (P. 25)
- For the voice guidance for key operation, the voice may become unclear when keys are pressed too quickly or the same key is held down.

## 10-8 Remote Controller Setting

This menu is available only when the optional remote controller EDS-12 is used. You can assign the functions listed in the table below to the remote controller keys as desired. The remote controller has four keys for function assignment: A through D.

- 1 Select <EDS-12 KEY> from the Set mode menu.
- 2 Press the  key to display the <EDS-12 KEY> sub menu.
- 3 Rotate the upper dial to select from “EDS-12 A button” to “EDS-12 D button”.
- 4 Rotate the lower dial to select the function assigned to the [A] to [D] key.

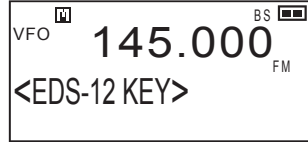

Initial assignment	Menu name	Function
KEY A	Active band	
KEY B	Band change	
KEY C	Freq. up	Holding down the key (approx. 2 seconds) starts scanning.
KEY D	Freq. down	Holding down the key (approx. 2 seconds) starts scanning.
	Select input	* The setting is switched every time the key is pressed (P. 103).
	MONI key	
	V/P/M key	
	Volume up	
	Volume down	
	Sql. level up	
	Sql. level down	
	Attenuator	
	Antenna	
	Bar antenna	
	Priority	
	RF gain	
	AF tone	
	Beep	
	Bell	
	CTCSS	
	CTCSS reverse	
	DCS	

\*This function selects whether to switch to the DJ-X11 automatically when the squelch opens, or to manually switch the audio input from the portable audio player.

# 11. Channel Display Mode

This mode displays only a bank and a channel number instead of a frequency in the Memory mode. Some other functions are also disabled. This mode is convenient for commercial users.

- 1 Program frequencies into the memory beforehand.**
- 2 Select the memory mode and turn the power OFF.**
- 3 Turn the power ON while holding down the [MONI] and  keys simultaneously.**

The LCD should appear like the figure on the right showing the bank and channel number.

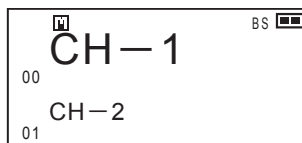

To cancel the Channel Display mode:  
Repeat the same operation as above.



**MEMO**

- In the Channel Display mode, all operations are disabled except for bank/channel selection, volume adjustment, squelch adjustment, Monitor/Mute function, Memory Scan, and Key-lock.
- The reset won't cancel Channel Display Mode.



# 12. Cable-clone and PC Connection Functions

The Cable-clone function copies data from one DJ-X11 to another DJ-X11. By connecting two DJ-X11 units with a cable, you can copy the information (including memory data) specified in the sending unit (herein referred to as “Master”) to the receiving unit (herein referred to as “Slave”). In addition to the Cable-clone function the following operations are possible when the DJ-X11 is connected to a PC.

## 12-1 PC Connection and Connection Ports

Note that the connection cables vary depending on the function to be used. The table also includes precautions for connecting an external speaker or earphone to the earphone jack.

	Cable-clone	PC connection		
Function	Copy the memory data and settings of the source DJ-X11 to another DJ-X11.	Set the function or memory of the DJ-X11 with a dedicated free utility software.	Operate the major functions of the DJ-X11 from the PC in real time by using the Remote function via terminal software or dedicated software.	Receive audio signals, detected signals, and IQ signals which are output from the DJ-X11 and use receiving software.
Cable	Commercially-available audio cable without resistance with ø3.5 mm stereo mini-plugs (3-pole) on both ends. This cable is commercially-available as an option for audio equipment or home appliances.	Alinco's optional cable ERW-4C, ERW-7 or ERW-8	Alinco's optional cable ERW-8	Commercially-available audio cable with ø3.5 mm stereo mini-plugs (3-pole) on both ends. This cable is commercially-available as an option for audio equipment or home appliances. You need to select a cable with or without resistance depending on the conditions such as the input port to the PC.
Connection Ports of DJ-X11 Ports	Earphone jacks of both units	ERW-7 (4C): Earphone jack ERW-8 : USB port of EDC-174	USB port of EDC-174	Earphone jack of DJ-X11
Connection of external device	-	USB port of the PC (Serial port for the ERW-4C)	USB port of the PC	LINE-IN or MIC port of the PC
Remark	-	This connection can also be used to update the firmware.	This connection can also be used to update the utility software and firmware.	-
Entry to Clone mode	Necessary (Turn on the power while holding down the [MONI] key.)	Necessary (Turn on the power while holding down the [MONI] key.)	Unnecessary	Unnecessary

● **Precautions common to all connections**

- Be sure to turn off both the DJ-X11 and external device before establishing any connection.
- The earphone jack of the DJ-X11 accepts a ø3.5 mm 4-pole stereo mini-plug. Refer to the diagrams below for wiring. A commonly-available 3-pole plug cable can also be used because the remote control terminal can be connected to the ground even while the EDS-12 is used and this terminal is not used for cable-cloning or PC connection.

● **Applicable plugs**

**(Wiring of 4-pole plug)**

The earphone jack of the DJ-X11 is wired as follows. Refer to the diagrams when you make a cable yourself. It is impossible to change the signals output to the terminals on the DJ-X11 side. Take other measures such as changing the wiring of the cable or changing the input setting of your receiving software.

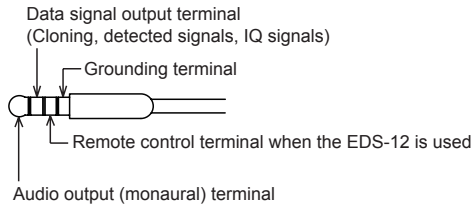

**(Use of a cable with 3-pole plugs)**

Terminals are arranged from the top in the order of the audio output (monaural) terminal, data signal output terminal (cloning, detected signals, IQ signals), and grounding terminal. The part for the remote control signal terminal for the EDS-12 in a 4-pole plug can be ignored.

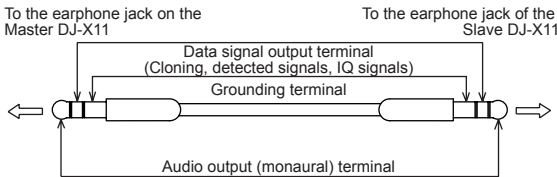

**(Use of 2-pole monaural plugs)**

If you use the DJ-X11 only to output signals to an earphone, an external speaker, ACARS software, or a low-speed packet TNC, you can use a cable, an earphone, or an external speaker with ø3.5 mm 2-pole monaural plugs. The earphone antenna function of the DJ-X11 can be used even with third-party earphones of such a structure. When you use these devices, set the DJ-X11 not to output detected signals and IQ signals.

## 12-2 Cable-Clone Receiving Data

Use the following procedure to copy data from another DJ-X11 or to receive data edited on a PC.

- 1** Turn OFF the Slave and connect the stereo mini-plug cable to its earphone jack.
- 2** While holding down the [MONI] key, press the  [POWER] key to turn ON the Slave.  
"CLONE" appears on the LCD and the Slave enters Clone mode.
- 3** Wait until the Master DJ-X11 or PC sends data.
- 4** When the data transfer is complete, the DJ-X11 automatically returns to VFO mode.

CLONE 57600bps



- The stereo mini-plug cable should be a direct-coupled type. (without an internal resistor)
- Do not operate any key while data is transferred by the clone function.
- Do not unplug the cable while data is being transferred. Doing so will suspend the data transfer operation, and "ERROR" will be displayed on the Master's LCD. if this happens, perform the reset (P.101) to the slave unit and retry.
- Note that the cloning procedure overwrites all data stored in the Slave with the Master's data. Make sure that the Slave does not have any necessary data.

## 12-3 Cable-Clone Transferring Data

The procedure below does not necessitate using the PC Connection function.

- 1** Turn OFF the Master and connect the stereo mini-plug cable to its earphone jack.
- 2** While holding down the [MONI] key, press the  [POWER] key to turn ON the Master.  
"CLONE" appears on the LCD and the Master enters Clone mode.

- 3** While "CLONE" is displayed on the LCD, press the dial. The LCD shows something like the figure on the right and the data on the Master is transferred to the Slave.

The number increases.

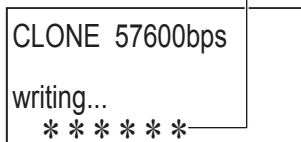

CLONE 57600bps  
writing...  
\*\*\*\*\*

- 4** When the data transfer finishes, "FINISH!!" appears on the LCD.

If "ERROR" appears on the LCD, repeat the procedure from step 1.

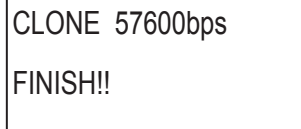

CLONE 57600bps  
FINISH!!

- 5** Turn OFF the Master.

The Clone mode is not canceled unless you turn OFF the Master.

# 13. Reset Function

The DJ-X11 provides two types of reset operations: Partial reset which initializes only the Set mode and LCD display settings; and All reset which deletes memory data as well.



- Remember that you cannot restore data deleted in Memory mode.

## 13-1 Reset

This function resets the DJ-X11 to the condition before shipment.

Use this function if you get lost while operating the DJ-X11 or if the DJ-X11 does not operate properly.

- **Partial reset**

- 1 Turn off the DJ-X11**
- 2 While holding down the [FUNC] key, turn on the DJ-X11.**
- 3 When “Reset completed” appears on the LCD, release the key.**

- **All reset**

This function is not used under normal conditions. The All reset should be used only by advanced users on rare occasions such as to edit all memory data by themselves. For the procedure, refer to (P. 106).

# 14. Using the Optional Remote Controller

## 14-1 Using the Remote Controller

### 14-1-1 Top/Bottom/Front panels

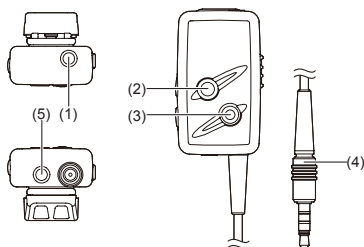

No.	Item	Description
(1)	Earphone jack	Earphone output jack. Connect earphones or other output devices.
(2)	Operation key A	Used to change the band to be operated (MAIN/SUB).
(3)	Operation key B	Used to switch the frequency bands.
(4)	Earphone cord	Plug this cord into the earphone jack of the DJ-X11
(5)	Audio input jack	Connect an MP3 player or other portable audio player. using its appropriate AUX in/output accessory cable.

### 14-1-2 Side panel

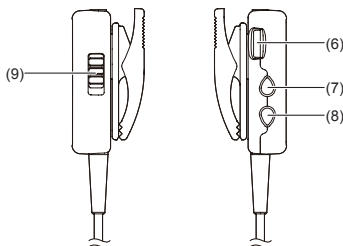

No.	Item	Description
(6)	Volume control	Used to adjust the volume of DJ-X11. The volume of connected audio device from the audio input jack (5) cannot be changed.
(7)	Operation key C	Increase the frequency.
(8)	Operation key D	Decrease the frequency.
(9)	Lock switch	Used to lock the keys of the remote controller.

## 14-2 Connecting the Remote Controller

The following figure shows the connection of the remote controller.

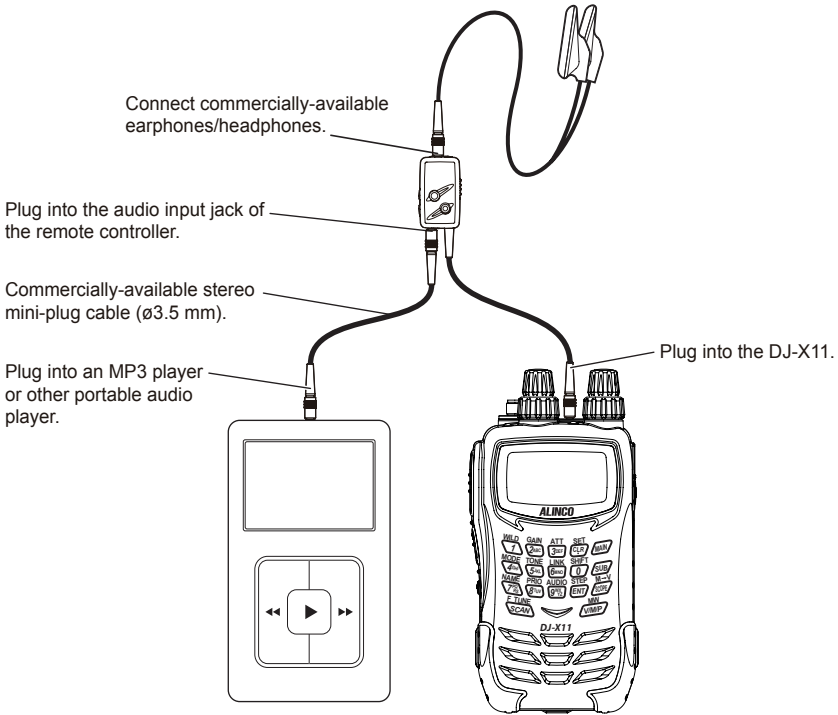

## 14-3 Remote Controller Functions

- Both monaural and stereo earphones/headphones can be used.
- You can connect an MP3 player or other portable audio player to the remote controller and listen to music in stereo sounds. When the squelch opens, the input is automatically switched to the DJ-X11.
- You can assign functions you wish to the operation keys A, B, C and D. (See page P95)

# 15. Maintenance and Reference

## 15-1 Troubleshooting

Please check the list below before concluding that the receiver is faulty.

If a problem persists even after performing the actions below, try resetting the receiver. This may correct erroneous operations.

Symptom	Possible Cause	Action
Nothing appears on the LCD when you turn the power ON.	Poor battery contact	Check that the battery terminals are clean.
	Flat batteries	Recharge the battery pack or replace dry-cell batteries with new ones.
	Releasing the [PWR] key too quickly	Press the [PWR] key for 1 second until the receiver turns on.
No speaker audio/ No reception	Volume level is too low.	Adjust the volume level.
	Squelch level is too high.	Adjust the squelch level.
	Tone Squelch is ON.	Deactivate the Tone Squelch.
	Mute function is ON.	Deactivate the Mute function.
Frequency display is incorrect. DJ-X11 doesn't operate properly.	CPU error	Uninstall the batteries or unplug the external power supply. Wait for at least 10 seconds, and reinstall the batteries or reconnect the power supply. If the problem persists, reset the receiver.
The receiver does not scan.	Squelch is open.	Adjust the squelch level until noise disappears.
Frequency and memory channel number do not change.	Key-lock is ON.	Release the Key-lock.
Keys do not operate.	Key-lock is ON.	Release the Key-lock.
The display flashes or goes off during signal reception.	The battery power is low.	Charge the battery back or replace the dry batteries with new ones.
Charging fails.	The charging terminals of the charger are dirty.	Wipe off the dirt on the charging terminals and the contacts of the battery pack with a dry cloth.



- If you need after-sales service or support, contact your Alinco dealer.  
To search for your nearest dealer, use the “DISTRIBUTION” page on our web site (<http://www.alinco.com/usa.html>).
- For the DJ-X11, updated firmware (operating program written on the chip inside the receiver) may be delivered from the web site.  
Consequently, your DJ-X11 may operate differently from the description in this manual depending on its firmware version.
- Before you contact our service center about the DJ-X11, please check the firmware version by following the procedure below:
  1. Hold down the [FUNC] key for approximately one second to activate the Key-lock.
  2. Press the  key 10 times continuously to display the version number.
  3. Press the [FUNC] key to return to the operation mode.

## 15-2 Optional Accessories List

- Soft Case (ESC-50)
- Curl-Cable Earphone (EME-26)
- Miniature Earphone (EME-6)
- Cigarette Lighter Cable (EDH-33)
- Remote Controller (EDS-12)
- PC Connection Cable (ERW-4C: Serial port)
- PC Connection Cable (ERW-7: ø3.5 mm to USB)
- PC Connection Cable (ERW-8: Mini USB to USB)

## 15-3 After-sales Service

### ■ Warranty period

Please ask warranty policy to your dealer before purchase.

### ■ After the warranty period

Contact your Alinco dealer or service contact. If the performance can be retained by repairing the product, we will repair it at cost on your request. If you have any questions about after-sales service, contact your Alinco dealer or service contact.

If you have any questions about after-sales service, contact your Alinco dealer or service contact.

### ■ Service limit for discontinued products

As for discontinued products, service parts will be in stock for the specified period shown below.

Note, however, that stock may run out earlier due to unexpected conditions, making repair impossible.

\* The warranty period for service parts is five years after discontinuation.



\* For more information on our customer service, visit our web site at (<http://www.alinco.com/>).

## All reset operations



MEMO

- Procedure for All Reset which includes deletion of all memory channel data  
The procedure for the normal reset is described on (P. 101).

- 1 While holding down the [FUNC], , and  keys, turn on the DJ-X11.
- 2 When "All reset completed" appears on the LCD, release the keys.



CAUTION

- Note that you cannot restore the memory after All reset unless you made a backup using the clone utility.

# 16. Index

## NUMBER

1MHz UP/DOWN ..... 30

## A

AC adapter ..... 17  
 APO ..... 81  
 ATH ..... 49  
 ATL ..... 49  
 All reset ..... 101  
 Antenna connector ..... 22  
 Antenna ..... 14  
 Attenuator ..... 48, 49  
 Auto power off ..... 81

## B

BS ..... 82  
 BUG ..... 36, 72  
 BUSY ..... 27  
 Band to be operated ..... 28  
 Band transition ..... 84  
 Bank link setting function ..... 54  
 Bar antenna ..... 74  
 Battery level ..... 20, 82  
 Battery pack ..... 15, 82  
 Battery save function ..... 82  
 Battery setting ..... 82  
 Bell function ..... 93  
 Belt clip ..... 15  
 Bug Detector function ..... 69

## C

CTCSS ..... 51  
 CW ..... 50, 76  
 CWL ..... 76  
 CWU ..... 76  
 Charger ..... 18  
 Channel Display mode ..... 96  
 Channel Scope function ..... 59  
 Channel step ..... 30, 58  
 Clone ..... 97  
 Contrast setting ..... 79

## D

DC jack ..... 17  
 DCS scan ..... 67  
 DCS ..... 53  
 Detected signal output function ..... 76  
 Dial ..... 21  
 Display setting ..... 78, 92  
 Dry battery case ..... 19  
 Dual-band ..... 28

## E

ENT ..... 23  
 Earphone ..... 102, 103, 105

## F

F Tuning ..... 62, 77  
 FUNC key ..... 22  
 Font size setting ..... 79  
 Font style setting ..... 79  
 Frequency ..... 25

## H

Hand strap ..... 14

## I

IQ signal ..... 77, 97  
 Illumination setting ..... 78

## K

Key assignment setting ..... 83  
 Key pad ..... 21  
 Key-lock ..... 63

## L

LCD ..... 24  
 Language setting ..... 78  
 Lithium ion battery ..... 15

## M

M → V	62
MAIN key	23
MONI key setting	87
MONI key	22
Main RX lamp	22
Main band	21, 24, 28
Main dial	21
Memory Name	41, 92
Memory bank	34
Memory channel scope	61
Memory channel	35, 38
Memory mode	29, 34
Memory protection	91
Memory scan	65
Memory setting	91
Memory skip	40
Mode coupling setting of the bug detector function	71
Modulation mode	50
Monitor function	27
Mono-band	28
Mute function	27

## O

Operating mode	29
----------------	----

## P

PASS	36
PC connection function	97
POWER key	22
PRG	36
PRIO	36
Packet communication	76, 83
Partial reset	101
Periodic scan	89
Power and Battery Setting	81
Preset mode	29, 31, 75
Preset scan	65
Priority monitoring	34, 55, 89
Programmed scan	34, 66

## Q

Quick memory	40
--------------	----

## R

Receiver setting	74
Remote COM port	88
Remote controller	95, 102
Reset function	101

## S

SCAN key	23
SUB key	23
Scanning function	64
Scan mode setting	88
Sensitivity setting of the bug detector function	72
Set mode exit time	84
Set mode	73, 74
Silent mode	69
Skip setting	90
Sound mode	70
Sound setting	92
Squelch	26
Sub RX lamp	22
Sub band	28
Sub dial	21
Sweep scan	68

## T

TSQ	51
Tone Squelch function	51
Tone scan	66
Turning the Power ON	25

## V

V/P/M key	23
VFO mode	29, 30
VFO scan	64
Voice guidance	94
Volume	25

## W

WILD key	86
----------	----

# 17. Specifications

## 17-1 Specifications

Receivable frequency range	Receivable frequency range (Main band): 0.05 to 1300MHz Receivable frequency range (Sub band): 118 to 171MHz, 336 to 470MHz (USA T version: cellular frequencies [824.000 ~ 849.9995MHz, 869.000 ~ 894.9995MHz] are blocked.)
Frequency step	0.05/0.1/1/5/6.25/8.33/10/12.5/15/20/25/30/50/100/125/150/200/500kHz/1MHz
Modulation mode	AM/SSB/CW/FM/WFM
Power supply voltage	Operating range (External power supply port): 5.4 ~ 6VDC Standard battery: 4.5V (AA battery), 3.7V (Lithium ion battery)
Current consumption	Average: Mono-band: Approx. 130mA, Dual-band: Approx. 180mA (6.0VDC)
Operating temperature range	-10°C ~ +60°C per CE (+14°F ~ +140°F)
Dimensions	61 (W) x 106 (H) x 38 (D) mm / 2.4 (W) x 4.17 (H) x 1.50 (D) in (projection exclusive)
Weight	Approx. 235g / 8.29oz (antenna and lithium ion battery pack inclusive)
Receiver	<p>Reception method (Main band): AM/SSB/CW/FM: Triple-conversion Super-heterodyne WFM: Double-conversion Super-heterodyne</p> <p>Reception method (Sub band): AM/FM: Double-conversion Super-heterodyne</p> <p>Intermediate frequency: AM/SSB/CW/FM (Main band): 1st intermediate frequency: 243.95MHz 2nd intermediate frequency: 45.055MHz 3rd intermediate frequency: 455kHz</p> <p>WFM (Main band): 2nd intermediate frequency: 10.7MHz</p> <p>AM/FM (Sub band): 1st intermediate frequency: 51.65MHz 2nd intermediate frequency: 450kHz</p> <p>Sensitivity (Main band): 0.050 to 0.531MHz (AM): 5dBμ (10dB S/N)typ 0.531 to 1.62MHz (AM): 2dBμ (10dB S/N)typ 1.62 to 76MHz (AM): -5dBμ (10dB S/N)typ 1.62 to 76MHz (SSB,CW): -10dBμ (10dB S/N)typ 1.62 to 76MHz (FM): -15dBμ (12dB SINAD)typ 76 to 108MHz (WFM): -3dBμ (12dB SINAD)typ 108 to 136MHz (AM): -6dBμ (10dB S/N)typ 136 to 174MHz (FM): -14dBμ (12dB SINAD)typ 175 to 221.75MHz (WFM): -6dBμ (12dB SINAD)typ 221.8 to 336MHz (AM): 0dBμ (10dB S/N)typ 336 to 475.75MHz (FM): -13dBμ (12dB SINAD)typ 475.75 to 770MHz (WFM): -13dBμ (12dB SINAD)typ 770 to 1260MHz (FM): -9dBμ (12dB SINAD)typ 1260 to 1300MHz (FM): -6dBμ (12dB SINAD)typ</p> <p>Sensitivity (Sub band): 118 to 136MHz (AM): -3dBμ (10dB S/N)typ 136 to 170MHz (FM): -14dBμ (12dB SINAD)typ 336 to 470MHz (FM): -14dBμ (12dB SINAD)typ</p> <p>Selectivity: AM/FM: -6dB/12kHz or more, -60dB/35kHz or less SSB/CW: -6dB/2kHz or more, -50dB/7.5kHz or less WFM: -6dB/180kHz±40kHz, -20dB/470kHz or less</p> <p>Audio output power: More than 100mW (8Ω)</p>

\* The ratings and specifications are subject to change without notice.

## 17-2 The Band-plans

### 17-2-1 Switching the main band

- E Pan-Europe version

Default (MAIN)	Frequency range
.150(AM)	(50 ~ 521kHz)*1
.522(AM)	(522 ~ 1620kHz)*2
1.625(AM)	(1.625 ~ 49.99995MHz)
51.000(FM)	(50.000 ~ 75.900MHz)
87.600(FM)	(76.000 ~ 87.99995MHz)
118.000(AM)	(88.000 ~ 141.975MHz)
145.000(FM)	(142.000 ~ 169.9875MHz)
180.750(WFM)	(170.000 ~ 229.750MHz)
270.000(AM)	(230.000 ~ 335.900MHz)
380.000(FM)	(336.000 ~ 429.9875MHz)
433.000(FM)	(430.000 ~ 469.9875MHz)
476.750(WFM)	(470.000 ~ 869.9875MHz)
870.000(FM)	(870.000 ~ 959.950MHz)
1295.000(FM)	(960.000 ~ 1299.9875MHz)

\*1 Selectable channel steps are 50 Hz, 100 Hz, and 1 kHz.

\*2 Selectable channel steps are 1 kHz and 9 kHz.

#### Preset mode

Default (SUB)	Frequency range
FM broadcasting	87.6 – 107.9MHz
Analog TV	2ch-12ch/21ch-69ch
AM broadcasting	0.522 – 1.620KHz

- E UK version

Default (MAIN)	Frequency range
.150(AM)	(50 ~ 521kHz)*1
.522(AM)	(522 ~ 1620kHz)*2
1.625(AM)	(1.625 ~ 49.99995MHz)
51.000(FM)	(50.000 ~ 72.795MHz)
72.800(FM)	(72.800 ~ 87.4875MHz)
118.000(AM)	(87.500 ~ 141.975MHz)
145.000(FM)	(142.000 ~ 169.9875MHz)
180.750(WFM)	(170.000 ~ 238.000MHz)
270.000(AM)	(240.000 ~ 335.400MHz)
380.000(FM)	(335.425 ~ 429.975MHz)
433.000(FM)	(430.000 ~ 446.09375MHz)
446.100(FM)	(446.100 ~ 917.000MHz)
917.0125(FM)	(917.0125 ~ 959.950MHz)
1295.000(FM)	(960.000 ~ 1299.9875MHz)

\*1 Selectable channel steps are 50 Hz, 100 Hz, and 1 kHz.

\*2 Selectable channel steps are 1 kHz and 9 kHz.

### Preset mode

Default (SUB)	Frequency range
FM broadcasting	87.6 – 107.9MHz
Analog TV	21ch-69ch
AM broadcasting	0.522 – 1.620KHz

- T,K, version

Default (MAIN)	Frequency range
.15(AM)	(50 ~ 529kHz)*1
.530 AM)	(530 ~ 28.99995MHz)*2
29.000 FM)	(29.000 ~ 59.745MHz)
59.750(WFM)	(59.750 ~ 107.99995MHz)
145.000(FM)	(108.000 ~ 215.99995MHz)
216.000(FM)	(216.000 ~ 399.99995MHz)
400.000(FM)	(400.000 ~ 959.99995MHz)
960.000(WFM)	(960.000 ~ 1299.99995MHz)

\*1 Selectable channel steps are 50 Hz, 100 Hz, and 1 kHz.

\*2 Selectable channel steps are 1 kHz and 9 kHz.

## 17-2-2 Switching the sub band

Press the  key and select from the following four bands displayed in this order.

Default (SUB)	Frequency range
118.000 (AM)	(118.000 ~ 141.995MHz)
145.000 (FM)	(142.000 ~ 170.995MHz )
352.000 (FM)	(336.000 ~ 429.995MHz )
433.000 (FM)	(430.000 ~ 469.995MHz )

- The default is set to "Auto". It is unnecessary to change the "Auto" setting under normal conditions. Change the setting to receive a frequency which cannot be tuned to automatically.
- For the sub band, channel steps of 50 Hz, 100 Hz through 1 kHz and 9kHz cannot be selected.



# **ALINCO, INC.**

Head Office: Yodoyabashi Daibiru Building 13th Floor  
4-4-9, Koraihashi, Chuo-ku, Osaka 541-0043, JAPAN

Phone: +81-6-7636-2363 Fax: +81-6-6208-3803

E-mail: [export@alinco.co.jp](mailto:export@alinco.co.jp)