

DJ – X11T/E/K

Service Manual

CONTENTS

SPECIFICATIONS..... 2

CIRCUIT DISCRIPTION

1) Receiver System 3~7
2) M30627FJ (E&K : XA1406 , T : XA1453) 8~11

SEMICONDUCTOR DATA

1) BU2152FS (XA1352) 12
2) NJM2070M (XA0210)..... 13
3) TC4W53FU (XA0348) 13
4) TK10931V (XA0666) 13
5) S-812C30AMC (XA0833) 13
6) M62367GP (XA0902) 14
7) upc2757TB (XA0976)..... 14
8) upc2746TB (XA0985)..... 14
9) NJM2594V (XA0995) 15
10) MM1438 (XA1013) 15
11) TC75S51FU (XA1014) 15
12) MB15F07SL (XA1033) 15
13) SM6451B (XA1186)..... 16
14) AT24C1024B (XA1351) 16
15) NJM12904 (XA1355)..... 16
16) LTC6904 (XA1405)..... 16
17) TC7WB66FK (XA1407) 17
18) TC74VHC74FK (XA1408) 17
19) TC1240 (XA1409) 17
20) BD4928 (XA1426) 17
21) Transistor, Diode and LED Outline Drawing.... 18
22) LCD Connection (EL0063) 19

EXPLODED VIEW

1) Front View (1)..... 20
1) Front View (2)..... 21
2) Rear View..... 22
3) Bottom View..... 23

PARTS LIST

CPU Unit 24~25
JACK Unit..... 25
LED Unit 26
RE Unit 26
MAIN Unit 26~30
Mechanical Unit..... 31
Packing Unit 31

ADJUSTMENT

Adjustment Mode..... 32~34

PC BOARD VIEW 35~39

SCHEMATIC DIAGRAM 41~43

BLOCK DIAGRAM 44

ALINGO, INC.

SPECIFICATIONS

Receivable frequency range	Receivable frequency range (Main band): 0.05 to 1300MHz Receivable frequency range (Sub band): 118 to 171MHz, 336 to 470MHz (USA T version: cellular frequencies [824.000 ~ 849.99995MHz, 869.000 ~ 894.99995MHz] are blocked.)
Frequency step	0.05/0.1/1/5/6.25/8.33/10/12.5/15/20/25/30/50/100/125/150/200/500kHz/1MHz
Modulation mode	AM/SSB/CW/FM/WFM
Power supply voltage	Operating range (External power supply port): 5.4 ~ 6VDC Standard battery: 4.5V (AA battery), 3.7V (Lithium ion battery)
Current consumption	Average: Mono-band: Approx. 130mA, Dual-band: Approx. 180mA (6.0VDC)
Operating temperature range	-10°C ~ +60°C per CE (+14°F ~ +140°F)
Dimensions	61 (W) x 106 (H) x 38 (D) mm / 2.4 (W) x 4.17 (H) x 1.50 (D) in (projection exclusive)
Weight	Approx. 235g / 8.29oz (antenna and lithium ion battery pack inclusive)
Receive	<p>Reception method (Main band): AM/SSB/CW/FM: Triple-conversion Super-heterodyne WFM: Double-conversion Super-heterodyne</p> <p>Reception method (Sub band): AM/FM: Double-conversion Super-heterodyne</p> <p>Intermediate frequency: AM/SSB/CW/FM (Main band) 1st intermediate frequency: 243.95MHz 2nd intermediate frequency: 45.055MHz 3rd intermediate frequency: 455kHz</p> <p>WFM (Main band): 2nd intermediate frequency: 10.7MHz AM/FM (Sub band): 1st intermediate frequency: 51.65MHz 2nd intermediate frequency: 450kHz</p> <p>Sensitivity (Main band): 0.050 to 0.531MHz (AM): 5dBμ (10dB S/N)typ 0.531 to 1.62MHz (AM): 2dBμ (10dB S/N)typ 1.62 to 76MHz (AM): -5dBμ (10dB S/N)typ 1.62 to 76MHz (SSB,CW): -10dBμ (10dB S/N)typ 1.62 to 76MHz (FM): -15dBμ (12dB SINAD)typ 76 to 108MHz (WFM): -3dBμ (12dB SINAD)typ 108 to 136MHz (AM): -6dBμ (10dB S/N)typ 136 to 174MHz (FM): -14dBμ (12dB SINAD)typ 175 to 221.75MHz (WFM): -6dBμ (12dB SINAD)typ 221.8 to 336MHz (AM): 0dBμ (10dB S/N)typ 336 to 475.75MHz (FM): -13dBμ (12dB SINAD)typ 475.75 to 770MHz (WFM): -13dBμ (12dB SINAD)typ 770 to 1260MHz (FM): -9dBμ (12dB SINAD)typ 1260 to 1300MHz (FM): -6dBμ (12dB SINAD)typ</p> <p>Sensitivity (Sub band): 118 to 136MHz (AM): -3dBμ (10dB S/N)typ 136 to 170MHz (FM): -14dBμ (12dB SINAD)typ 336 to 470MHz (FM): -14dBμ (12dB SINAD)typ</p> <p>Selectivity: AM/FM: -6dB/12kHz or more, -60dB/35kHz or less SSB/CW: -6dB/2kHz or more, -50dB/7.5kHz or less WFM: -6dB/180kHz\pm40kHz, -20dB/470kHz or less</p> <p>Audio output power: More than 100mW (8Ω)</p>

! NOTE: All specifications are subject to change without notice or obligation

CIRCUIT DESCRIPTION

1) Receiver System

Main band ; Triple Super heterodyne Conversion (AM,SSB,CW,FM)
Double Super heterodyne Conversion (WFM)
1st IF :243.95MHz
2nd IF :45.055MHz (AM,SSB,CW,FM)
2nd IF :10.7MHz (WFM)
3rd IF :455kHz (AM,SSB,CW,FM)
Sub band ; Triple Super heterodyne Conversion (AM,FM)
1st IF :51.65MHz
2nd IF :450kHz

1. Front end

Main band

[0.050-1.62MHz]

The incoming signal from the bar antenna passes through a low-pass filter and goes to the first amplifier (Q108), then the signal goes to the common mixer (IC104).

[0.050-49.99995MHz]

The incoming signal from the antenna goes to band switch circuitry (D142). The signal passes through the low-pass filter, then it is amplified at RF amplifier (Q131). The amplified signal goes to the common mixer (IC104).

[50-117.99995MHz]

The incoming signal from the antenna goes to band switch circuitry (D137). The signal passes through the low-pass filter, then it is amplified at RF amplifier (Q130). The amplified signal goes to the common mixer (IC104).

[118-170.99995MHz]

The incoming signal from the antenna goes to band switch circuitry (D124). The signal passes through the band-pass filter, then it is amplified at two RF amplifiers (Q114•Q121). The amplified signal through again the band-pass filter, then it is goes to the common mixer (IC104).

[171-274.99995MHz]

The incoming signal from the antenna goes to band switch circuitry (D132). The signal passes through the band-pass filter, then it is amplified at RF amplifier (Q122). The amplified signal goes to the common mixer (IC104).

[275-469.99995MHz]

The incoming signal from the antenna goes to band switch circuitry (D150•D151). The signal passes through the band-pass filter, then it is amplified at two RF amplifiers (Q136•Q148). The amplified signal through again the band-pass filter, then it is goes to the common mixer (IC104).

[470-869.99995MHz]

The incoming signal from the antenna goes to band switch circuitry (D160). The signal passes through the band-pass filter, then it is amplified at RF amplifier (Q157). The amplified signal goes to the common mixer (IC104).

Note that the cellular-phone band block system is mentioned on the separated sheet for the T-version.

[870-1299.99995MHz]

The incoming signal from the antenna goes to band switch circuitry (D161). The signal passes through the band-pass filter, then it is amplified at RF amplifier (Q158). The amplified signal goes to the common mixer (IC104).

Sub band

[118-170.995MHz]

The incoming signal from the antenna goes to band switch circuitry (D124). The signal passes through the band-pass filter, then it is amplified at two RF amplifiers (Q114-Q115). The amplified signal through again the band-pass filter, then it is goes to the common mixer (IC104).

[336-469.995MHz]

The incoming signal from the antenna goes to band switch circuitry (D150-D151). The signal passes through the band-pass filter, then it is amplified at two RF amplifiers (Q136-Q137). The amplified signal through again the band-pass filter, then it is goes to the common mixer (IC104).

2. Mixer

Main band

[The 1st Mixer]

The 1st local oscillator signal for the 1st mixer is supplied from the VCO. The incoming signal to the 1st mixer (IC104) and the 1st local signal are added or subtracted at mixer (IC104), and the SAW filter (FL101) selects the signal of 243.95MHz, then it goes to the 2nd mixer (IC105) after the adjacent signal is eliminated.

[The 2nd Mixer]

The 2nd local oscillator signal for the 2nd mixer is supplied from the VCO.

{FM/AM/SSB/CW}

In FM/AM/SSB/CW mode, the signal heterodowned to the 2nd IF of 45.055MHz by the mixer passes through a crystal filter (XF101) and unwanted signal components are eliminated.

The resulting signal is amplified by the 2nd IF amplifier (Q110) and goes to the IFIC (IC107).

{WFM}

In WFM mode, the signal heterodowned to the 2nd IF of 10.7MHz by the mixer passes through a ceramic filter (FL102) and unwanted signal components are eliminated.

The resulting signal is amplified by the IF amplifier (Q112) and goes to the IFIC (IC107).

[The 3rd Mixer]

The 3rd local oscillator signal for the 3rd mixer is 455kHz signal that is produced by multiplying the 44.6MHz (X103).

Sub band

[The 1st Mixer]

The 1st local oscillator signal for the 1st mixer is supplied from the VCO. The incoming signal to the 1st mixer (IC111) and the 1st local signal are added or subtracted at mixer (IC111), and the crystal filter (XF102) selects the signal of 51.65MHz. The resulting signal is amplified by the 2nd IF amplifier (Q147) and goes to the IFIC (IC113).

[The 2nd Mixer]

The 2nd local oscillator signal for the 2nd mixer is 450kHz signal that is produced by multiplying the frequency 51.2MHz that is multiplied 12.8MHz (X101) by 3 at (Q160).

3. IF Main band

[FM]

In FM mode, the signal passes through an external ceramic filter (FL103) and switch (D143-D146), and goes back to the IF IC (IC107).

The signal is amplified by the internal IF amplifier is demodulated by the quadrature FM demodulation circuit using a ceramic discriminator (X104) and output as an AF signal.

[AM]

In AM mode, the signal passes through an external ceramic filter (FL103) and switch (D143-D146), and goes back to the IF IC (IC107). The 2nd IF amplifier (Q110) is controlled by reverse AGC at AGC amplifier (Q116) to get better audio output even though the input is changed, and the gain is controlled.

[SSB/CW]

In SSB mode, the signal passes through two external ceramic filters (FL103-FL104) and switch (D143-D146), and goes back to the IF IC (IC107). The 2nd IF amplifier (Q110) is controlled by reverse AGC at AGC amplifier (Q116) to get better audio output even though the input is changed, and the gain is controlled.

The amplified signal is mixed with the oscillator signal for the silicon oscillator (IC501) from the Demodulate (IC505) to AF signal.

[WFM]

In WFM mode, the signal of 10.7MHz passes through WFM switch (D149) and goes to the IF IC (IC107).

The signal is amplified by the internal IF amplifier is demodulated by the quadrature FM demodulation circuit using a ceramic discriminator (X102) and output as an AF signal.

Sub band

[FM]

In FM mode, the signal passes through an external ceramic filter (FL105) and goes back to the IF IC (IC113).

The signal is amplified by the internal IF amplifier is demodulated by the quadrature FM demodulation circuit using a ceramic discriminator (X106) and output as an AF signal.

[AM]

In AM mode, the signal passes through an external ceramic filter (FL105) and goes back to the IF IC (IC113). The 2nd IF amplifier (Q147) is controlled by reverse AGC at AGC amplifier (Q155) to get better audio output even though the input is changed, and the gain is controlled.

4. Squelch Main band

The AF signal got from pin 12 of IF IC (IC107) is fed to pin 19 of IF IC (IC107). The input signal is output from pin 21 of IF IC (IC107) passing through the noise filter amplifier and rectifier circuits inside of IF IC (IC107). The rectified signal is added to the A/D port of the microcomputer (IC511). Judging the signal, the microcomputer controls ON/OFF of the audio output.

Sub band

The AF signal got from pin 12 of IF IC (IC113) is fed to pin 19 of IF IC (IC113). The input signal is output from pin 21 of IF IC (IC113) passing through the noise filter amplifier and rectifier circuits inside of IF IC (IC113). The rectified signal is added to the A/D port of the microcomputer (IC511). Judging the signal, the microcomputer controls ON/OFF of the audio output.

5. Audio Main band

[FM/AM/SSB/CW]

The AF signal goes to the switching IC (IC108•IC514). The switched signal passes through the electronic volume (IC512) and goes to active filter (Q514).

The adjusted signal goes to the AUDIO IC (IC515) and drives a speaker, etc.

[WFM]

The AF signal goes to the switching IC (IC108•IC514). The switched signal passes through the electronic volume (IC512).

The adjusted signal goes to the AUDIO IC (IC515) and drives a speaker, etc.

Sub band

[FM/AM]

The AF signal goes to the switching IC (IC510). The switched signal passes through active filter (Q514) and goes to the electronic volume (IC512).

The adjusted signal goes to the AUDIO IC (IC515) and drives a speaker, etc.

6. VCO Main band

[The 1st Local]

The VCO for the 1st local consists of the Colpitts oscillator. (D107, D114) and (L105) determine the frequency, and they are oscillated at the transistor (Q102). The oscillated signal passes through the buffer amplifiers (Q103, Q104) and goes to the PLL-IC (IC106).

[The 2nd Local]

The VCO for the 1st local consists of the Colpitts oscillator. (D123, D126) and (L121) determine the frequency, and they are oscillated at the transistor (Q111). The oscillated signal passes through the butter amplifier (Q113) and goes to the PLL-IC (IC106).

Sub band

[The UHF Local]

The VCO for the 1st local consists of the Colpitts oscillator. D164, D165 and L180 determine the frequency, and they are oscillated at the transistor (Q162). The oscillated signal passes through the buffer amplifiers (Q161) and goes to the PLL-IC (IC101).

[The VHF Local]

The VCO for the 1st local consists of the Colpitts oscillator. (D166•D167) and (L181) determine the frequency, and they are oscillated at the transistor (Q163). The oscillated signal passes through the buffer amplifiers (Q161) and goes to the PLL-IC (IC101).

7. PLL

Main band

PLL-IC (IC106) is used to control the oscillation frequency of VCO. The microcomputer (IC511) sends the signal with serial data to PLL-IC (IC106). The 12.9MHz reference frequency of PLL-IC (IC106) oscillates the crystal oscillator (X101).

Sub band

PLL-IC (IC101) is used to control the oscillation frequency of VCO. The microcomputer (IC511) sends the signal with serial data to PLL-IC (IC101). The 12.9MHz reference frequency of PLL-IC (IC101) oscillates the crystal oscillator (X101).

2) M30627FJ (E&K : XA1406 , T : XA1453) CPU

Terminal Connection
(TOP VIEW)

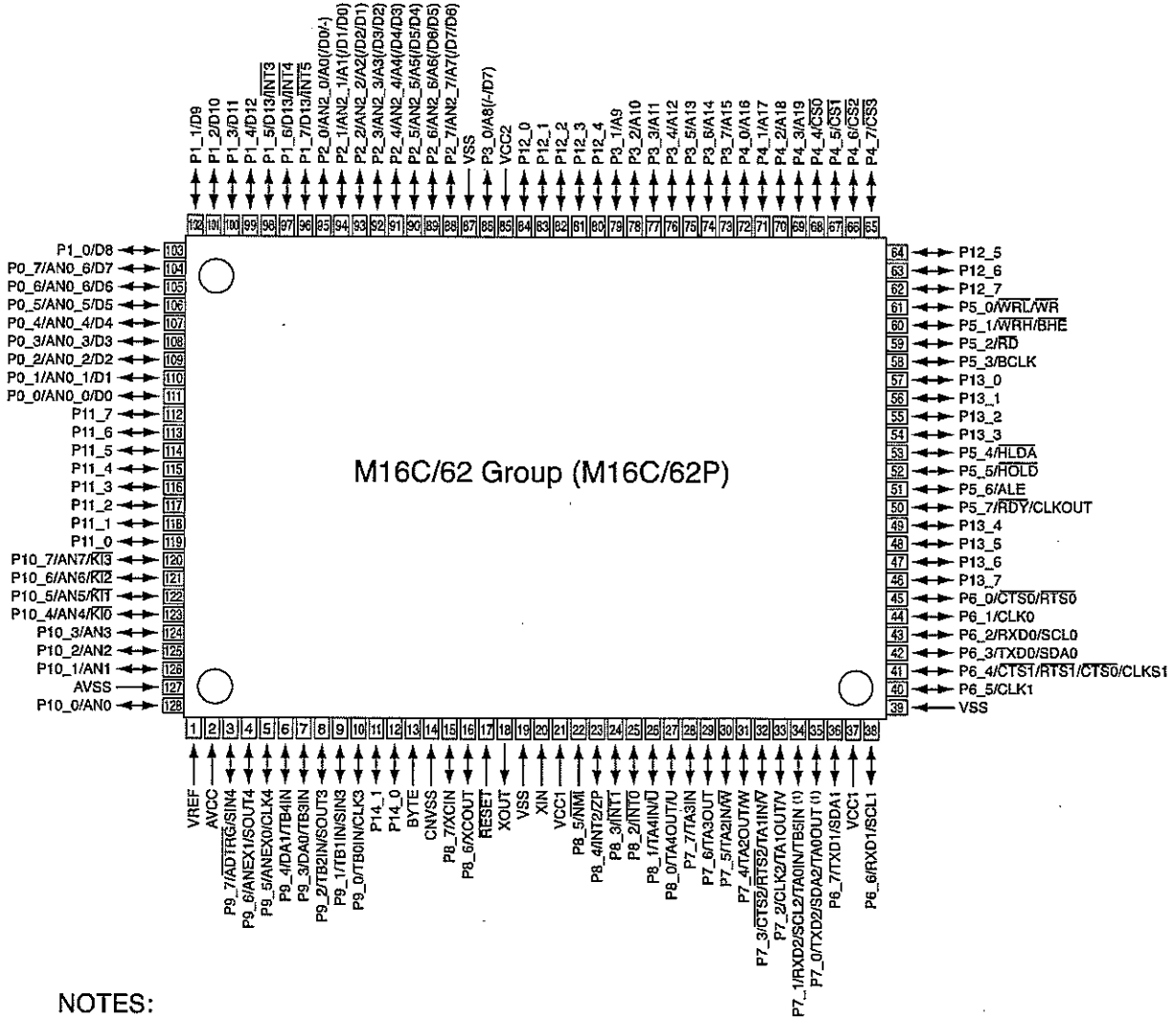

NOTES:

- 1.P7_0 and P7_1 are N channel open-drain output pins.

No.	Terminal	Signal	I/O	Description
1	VREF	VDD1	—	Power supply
2	AVCC	VDD1	—	Power supply
3	P9_7	PCNT	O	Power voltage detection SW
4	P9_6	LFTSW	I	LFT key input
5	P9_5	MONISW	I	MONI key input
6	P9_4	MSCRAJ	O	Secret signal leak control
7	P9_3	VOICE	O	Voice output
8	P9_2	fp1	I	F tune signal input
9	P9_1	BFS DI	I/O	Signal data I/O for BFO
10	P9_0	MAFS1	I	Main AF SW
11	P14_1	SCK	I/O	Signal clock for EEPROM
12	P14_0	SDI	I/O	Signal data for EEPROM
13	BYTE	VSS	—	CPU GND
14	CNVSS	VSS	—	CPU GND
15	P8_7	BP2	I	Band plan 2 detection
16	P8_6	WAF	O	WFM AF SW
17	RESET	RST	I	Reset input
18	XOUT	XOUT	O	Clock output
19	VSS	VSS	—	CPU GND
20	XIN	XIN	I	Clock input
21	VCC1	VDD1	—	Power supply
22	P6_5	VDS	—	Power supply
23	P6_4	BU	I	Back up signal detection input
24	P6_3	R1A	I	Rotary encoder B input 1A
25	P6_2	R2A	I	Rotary encoder B input 2A
26	P6_1	R1B	I	Rotary encoder B input 1B
27	P6_0	BEEP	O	Beep output
28	P7_7	R2B	I	Rotary encoder B input 2B
29	P7_6	MSCRF	O	Secret signal output
30	P7_5	FNCSW	I	FUNC key input
31	P7_4	BP1	I	Band plan 1 input
32	P7_3	AFHC	O	AF high sound control
33	P7_2	RPUSH	I	Rotary encoder B push SW input R
34	P7_1	RXD	I	Clone data reception input
35	P7_0	TXD	O	Clone data transmission output
36	P6_7	AFLC	O	AF low sound control
37	VCC1	VDD1	—	Power supply
38	P6_6	BFSCK	I/O	Signal clock I/O for BFO
39	VSS	VSS	—	CPU GND
40	P6_5	/CS1	O	Chip Select signal
41	P6_4	/RES	O	External reset pin
42	P6_3	A0	O	Display data select signal
43	P6_2	WR	O	Read/Write execution control signal
44	P6_1	/RD	O	Read/Write enable control signal
45	P6_0	MGLC	O	Main Green LED SW
46	P13_7	D0	O	Display data signal
47	P13_6	D1	O	Display data signal
48	P13_5	D2	O	Display data signal
49	P13_4	D3	O	Display data signal
50	P5_7	NC	—	—

No.	Terminal	Signal	I/O	Description
51	P5_6	NC	—	—
52	P5_5	NC	—	—
53	P5_4	NC	—	—
54	P13_3	D4	O	Display data signal
55	P13_2	D5	O	Display data signal
56	P13_1	D6	O	Display data signal
57	P13_0	D7	O	Display data signal
58	P5_3	TP	—	For firmware update
59	P5_2	NC	—	—
60	P5_1	NC	—	—
61	P5_0	CLNC	O	Clone SW
62	P12_7	RCAFS	O	AF SW
63	P12_6	SGLC	O	Sub Green LED SW
64	P12_5	SRLC	O	Sub Red LED SW
65	P4_7	NC	—	—
66	P4_6	SPC	O	Audio SW
67	P4_5	SDRSW	I	SDR SW
68	P4_4	AFPC	O	Audio power SW
69	P4_3	RCSW	I	Remote controller AF SW
70	P4_2	NC	—	—
71	P4_1	STRNC	O	Sub Carrier Canceling function SW
72	P4_0	NC	—	—
73	P3_7	SSBC	O	SSB SW
74	P3_6	STNC	O	Sub Tone SQL function SW
75	P3_5	MTRNC	O	Main Carrier Canceling function SW
76	P3_4	MTNC	O	Main Tone SQL function SW
77	P3_3	KI0	I	Key matrix input
78	P3_2	KI1	I	Key matrix input
79	P3_1	KI2	I	Key matrix input
80	P12_4	KI3	I	Key matrix input
81	P12_3	KO0	—	Key matrix output
82	P12_2	KO1	—	Key matrix output
83	P12_1	KO2	O	Key matrix output
84	P12_0	KO3	O	Key matrix output
85	VCC2	VDD2	—	Power supply
86	P3_0	SAFS	O	Sub SF SW
87	VSS	VSS	—	CPU GND
88	P2_7	LED1	O	Backlight SW Key
89	P2_6	EARC	O	Earphone antenna SW
90	P2_5	MAMC	O	Main AM SW
91	P2_4	SAMC	O	Sub AM SW
92	P2_3	MPLC	O	Main PLL SW
93	P2_2	SPLC	O	Sub PLL SW
94	P2_1	LPUSH	I	Rotary encoder A push SW input L
95	P2_0	RE2B	I	Rotary encoder A input 2B
96	P1_7	DET	O	Ext power detection
97	P1_6	RE2A	I	Rotary encoder A input 2A
98	P1_5	RE1A	I	Rotary encoder A input 1A
99	P1_4	RE1B	I	Rotary encoder A input 1B
100	P1_3	AFC	O	AF SW

No.	Terminal	Signal	I/O	Description
101	P1_2	MVC2C	O	Main VCO SW output
102	P1_1	C3C	O	C3V SW
103	P1_0	BUG	O	Bugging SW output
104	P0_7	SUC	O	Sub UHF VCO SW output
105	P0_6	SVC	O	Sub VHF VCO SW output
106	P0_5	CHG	O	Charge function SW
107	P0_4	BAT	I	Battery voltage detection
108	P0_3	SSQL	I	Noise level input for squelch
109	P0_2	SSMT	I	Sub S-meter input
110	P0_1	MSQL	I	Noise level input for squelch
111	P0_0	MSMT	I	Main S-meter input
112	P11_7	STB1	O	Strobe for Main PLL
113	P11_6	STB2	O	Strobe for Sub PLL
114	P11_5	STB3	O	Strobe for parallel converter
115	P11_4	STB4	O	Strobe for D-A converter
116	P11_3	DATA	I/O	Serial data output/Unlock input
117	P11_2	CLK	O	Serial clock output
118	P11_1	SDCSC	O	Sub DCS SW
119	P11_0	MDCSC	O	Main DCS SW
120	P10_7	ADIN	I	Remote controller SW level input
121	P10_6	STIN	I	Sub Tone input
122	P10_5	MTIN	I	Main Tone input
123	P10_4	POSW	I	POWER key input
124	P10_3	MSCRC	O	Main SCR SW
125	P10_2	MAFS2	O	Main AF SW
126	P10_1	STB5	O	Strobe for Evol
127	AVSS	VSS	—	CPU GND
128	P10_0	BCHK	I	Power supply level input

SEMICONDUCTOR DATA

1) BU2152FS (XA1352) 24bit serial parallel driver

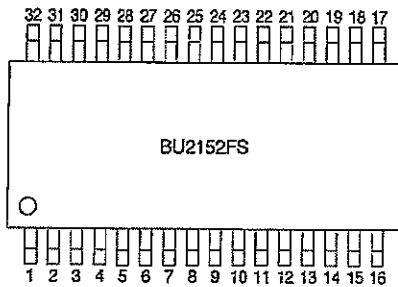

No.	Terminal	Signal	I/O	Description
1	VSS	GND	—	GND
2	CLK	CLK	I	Clock input
3	VSS	GND	—	GND
4	DATA	DATA	I	Data input
5	P1	ATT2C	O	ATT control output
6	P2	MBF7C	O	Main band 7 front end power
7	P3	WFMMC	O	WFM SW
8	P4	MBF4C	O	Main band 4 front end power
9	P5	MBF1C	O	Main band 1 front end power
10	P6	MBF6C	O	Main band 6 front end power
11	P7	SDRC	O	SDR SW
12	P8	NFMC	O	FM SW
13	P9	XTLC	O	Crystal power
14	P10	MSSBC	O	SSB SW
15	P11	AGCC	O	AGC control
16	P12	ERWSW	O	ERW-8 SW
17	P13	DB3C	O	Doubler 3 power
18	P14	DB2C	O	Doubler 2 power
19	P15	DB1C	O	Doubler 1 power
20	P16	ATT0C	O	ATT control output
21	P17	MBF2C	O	Main band 2 front end power
22	P18	MBF5C	O	Main band 5 front end power
23	P19	FCNTC	O	F tune power
24	P20	SBF5C	O	Sub band 5 front end power
25	P21	MBF3C	O	Main band 3 front end power
26	P22	SBF3C	O	Sub band 3 front end power
27	P23	BARC	O	Bar antenna SW
28	P24	ATT1C	O	ATT control output
29	SO	NC	—	NC
30	STB	STB3	I	Strobe input
31	CLB	CLB	I	Power supply
32	VDD	C3V	—	Power supply

2) NJM2070M (XA0210) Audio Power Amplifier

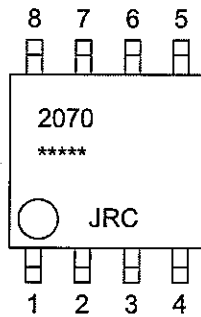

1. NC
2. + INPUT
3. - INPUT
4. GND
5. GND
6. OUTPUT
7. V+
8. NC

3) TC4W53FU (XA0348) Analog Multiplexer / De-multiplexer

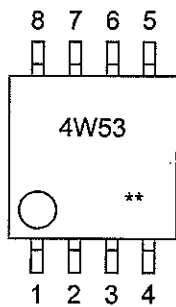

1. COMMON
2. INH
3. VEE
4. VSS
5. A
6. ch1
7. ch0
8. VDD

Control input		On channel
INH	A	
L	L	ch0
L	H	ch1
H	*	NONE

*Don't care

4) TK10931V (XA0666) AM / FM IF IC

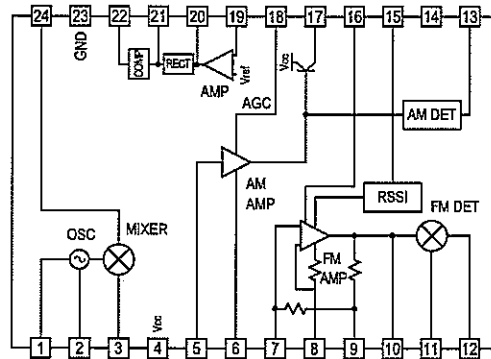
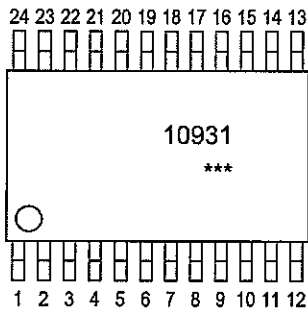

5) S-812C30AMC (XA0833) High operating voltage CMOS voltage regulator

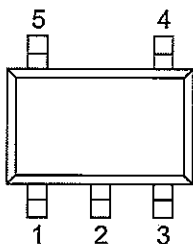

1. GND
2. V_{IN}
3. V_{OUT}
4. NC
5. NC

6) M62367GP (XA0902) 3V Type 8-bit 8ch D/A Converter with Buffer Amplifiers

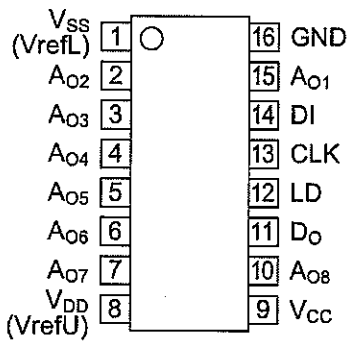

No.	Terminal	Signal	I/O	Description
1	VSS	GND	—	GND
2	V02	DETC	O	DET SW
3	V03	MATTC	O	Main RF gain control
4	V04	SATTC	O	Sub RF gain control
5	V05	REFAJ	O	Crystal control
6	V06	FTNC	O	F count SW
7	V07	XOAJ	O	Main IF control
8	VDD	C3V	—	Power supply
9	VCC	C3V	—	Power supply
10	A08	MIFC	O	Main IF IC power
11	D0	NC	—	NC
12	LD	STB4	I	Strobe input
13	CLK	CLK	I	Clock input
14	DI	DATA	I	Data input
15	A01	SIFC	O	Sub IF IC power
16	GND	GND	—	GND

7) upc2757TB (XA0976) MMIC Down-converter

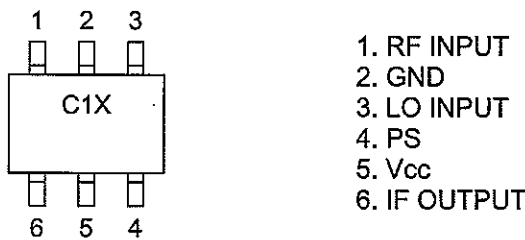

8) upc2746TB (XA0985) Bipolar Analog Integrated Circuits

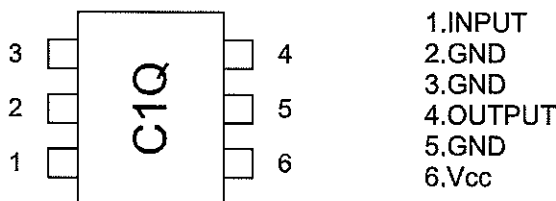

9) NJM2594V (XA0995) Double Balanced Modulation / Demodulation

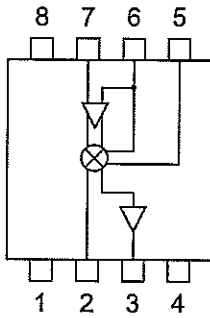

- 1. V+
- 2. Output 1
- 3. Output 2
- 4. GND
- 5. Signal Input
- 6. Bypass
- 7. Carrier Input
- 8. NC

10) MM1438 (XA1013) Monolithic IC

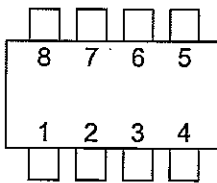

- 1. GND
- 2. LV
- 3. SW2
- 4. SW1
- 5. Vcc
- 6. EXT
- 7. CEL
- 8. CS

11) TC75S51FU (XA1014) Operational Amplifier

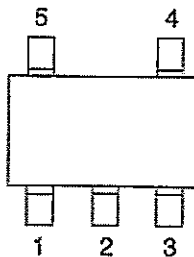

- 1. IN+
- 2. GND
- 3. IN-
- 4. OUT
- 5. VDD

12) MB15F07SL (XA1033) PLL Frequency Synthesizer

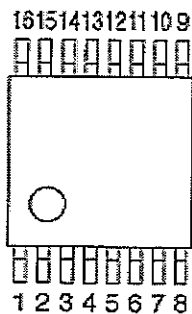

- | | |
|-----------|-----------|
| 1. GND2 | 9. Do2 |
| 2. OSC_IN | 10. PS2 |
| 3. GND1 | 11. Xfin2 |
| 4. fin1 | 12. VCC2 |
| 5. Vcc1 | 13. fin2 |
| 6. LD | 14. LE |
| 7. PS1 | 15. DATA |
| 8. Do1 | 16. Clock |

13) SM6451B (XA1186) Audio Variable Volume

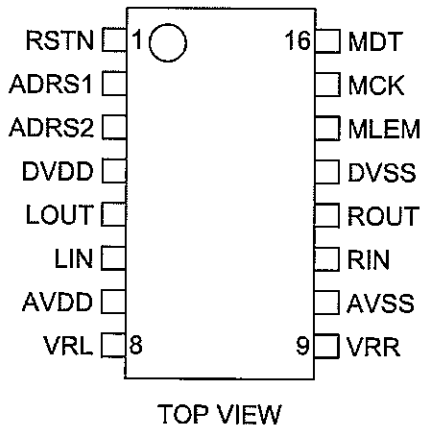

14) AT24C1024B (XA1351) EEPROM

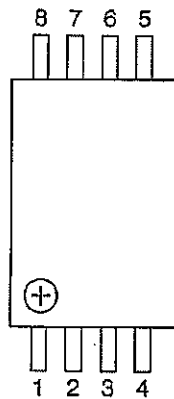

- 1.A0
- 2.A1
- 3.A2
- 4.GND
- 5.SDA
- 6.SCL
- 7.WP
- 8.V_{CC}

15) NJM12904 (XA1355) Single supply dual amplifier

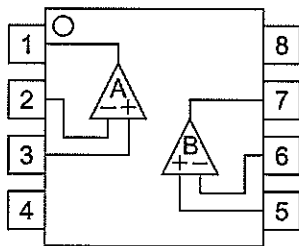

- 1.A OUTPUT
- 2.A -INPUT
- 3.A +INPUT
- 4.GND
- 5.B +INPUT
- 6.B -INPUT
- 7.B OUTPUT
- 8.V⁺

16) LTC6904 (XA1405) 1kHz - 68MHz Serial Port Programmable Oscillator

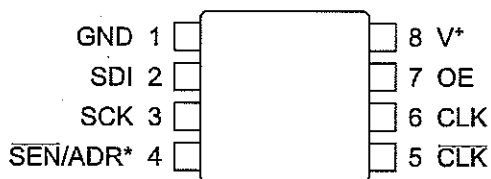

- 1.GND
- 2.SDI
- 3.SCK
- 4.SEN/ADR
- 5.CLK
- 6.CLK
- 7.OE
- 8.V⁺

17) TC7WB66FK (XA1407) Dual Bus Switch

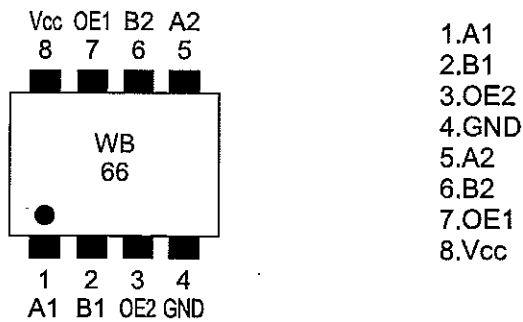

18) TC74VHC74FK (XA1408) Dual D-Type Flip-Flop with Preset and Clear

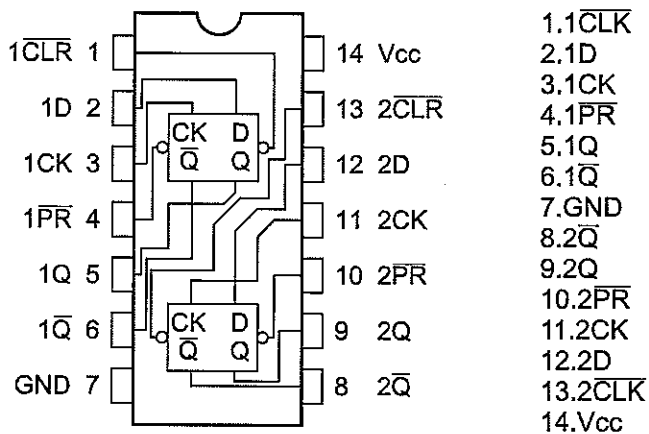

19) TC1240 (XA1409) Positive Doubling Charge Pumps with Shutdown

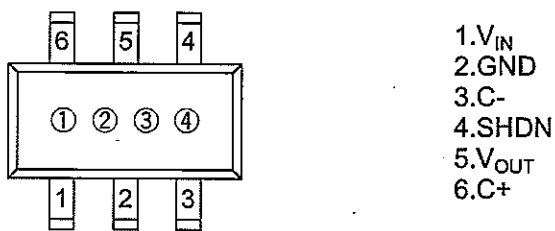

20) BD4928 (XA1426) Voltage Detector IC

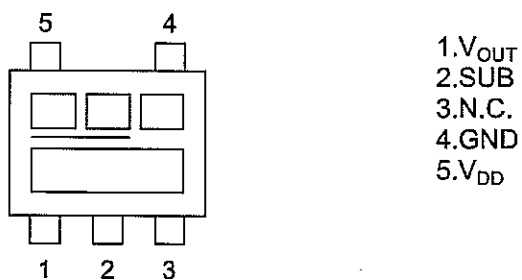

21) Transistor, Diode and LED Outline Drawings

Top View

XD0376 1SV282	XD0384 JDP2S02S	XD0396 VDZ3.9B	XD0401 DG1M3	XD0421 1SV323	XD0427 JDV2S14E	XD0432 JDS2S03S
XD0433 RB715W	XD0435 1SS361FV	XD0484 RB521CS	XD0494 1SS362FV	XD0495 HVD350B	XD0496 DA221M	XE0058 MCH6305
XE0069 SSM3K15FV	XE0081 RTR040N03	XE0090 SSM3J15FV	XE0095 RTL035N03	XE0098 2SK1875	XL0116 BRPY1211F	XL0128 SML-D12M8W
XT0178 2SC4915	XT0180 2SC5066	XT0195 MCH6102	XT0210 2SC6026	XT0212 2SA1955FV	XT0213 2SC5659	XT0214 HN2C01FE
XT0237 US6T7	XT0239 2SC5820	XT0240 2SC4250	XU0207 EMA8	XU0208 EMD3	XU0209 EMD6	XU0210 RN1107MFV
			 Rb=10kohm Rbe=47kohm	 Rb=10kohm Rbe=10kohm		 Rb=10kohm Rbe=47kohm
XU0212 RN2115MFV	XU0224 MT6C03AE	XU0226 RN1711				
 Rb=2.2kohm Rbe=10kohm						

22) LCD Connection (EL0063)

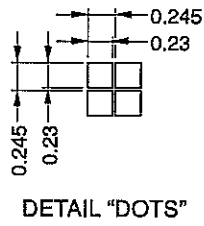
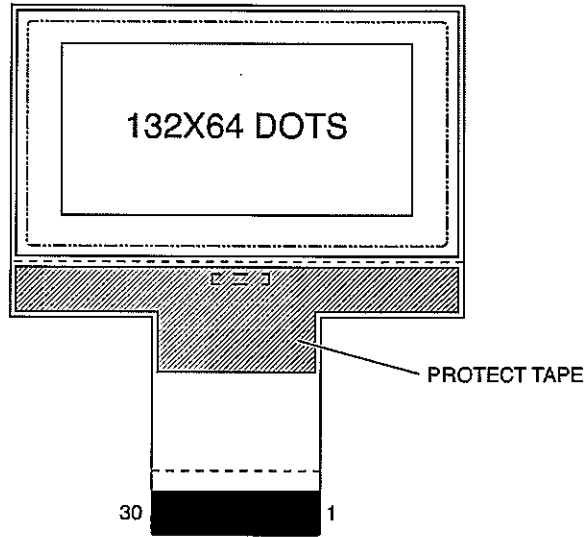

PIN	SYMBOL
1	P/S
2	C86
3	V0
4	V1
5	V2
6	V3
7	V4
8	CAP2N
9	CAP2P
10	CAP1P
11	CAPIN
12	CAP3P
13	V ^{OUT}
14	V ^{SS}
15	V ^{DD}

PIN	SYMBOL
16	D7
17	D6
18	D5
19	D4
20	D3
21	D2
22	D1
23	D0
24	/RD
25	WR
26	A0
27	/RES
28	/CS1
29	NC
30	NC

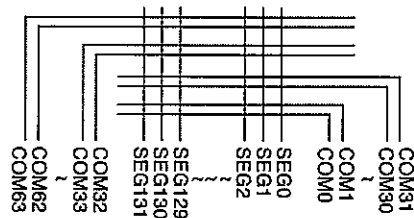

LAYOUT

EXPLODED VIEW

1) Front View (1)

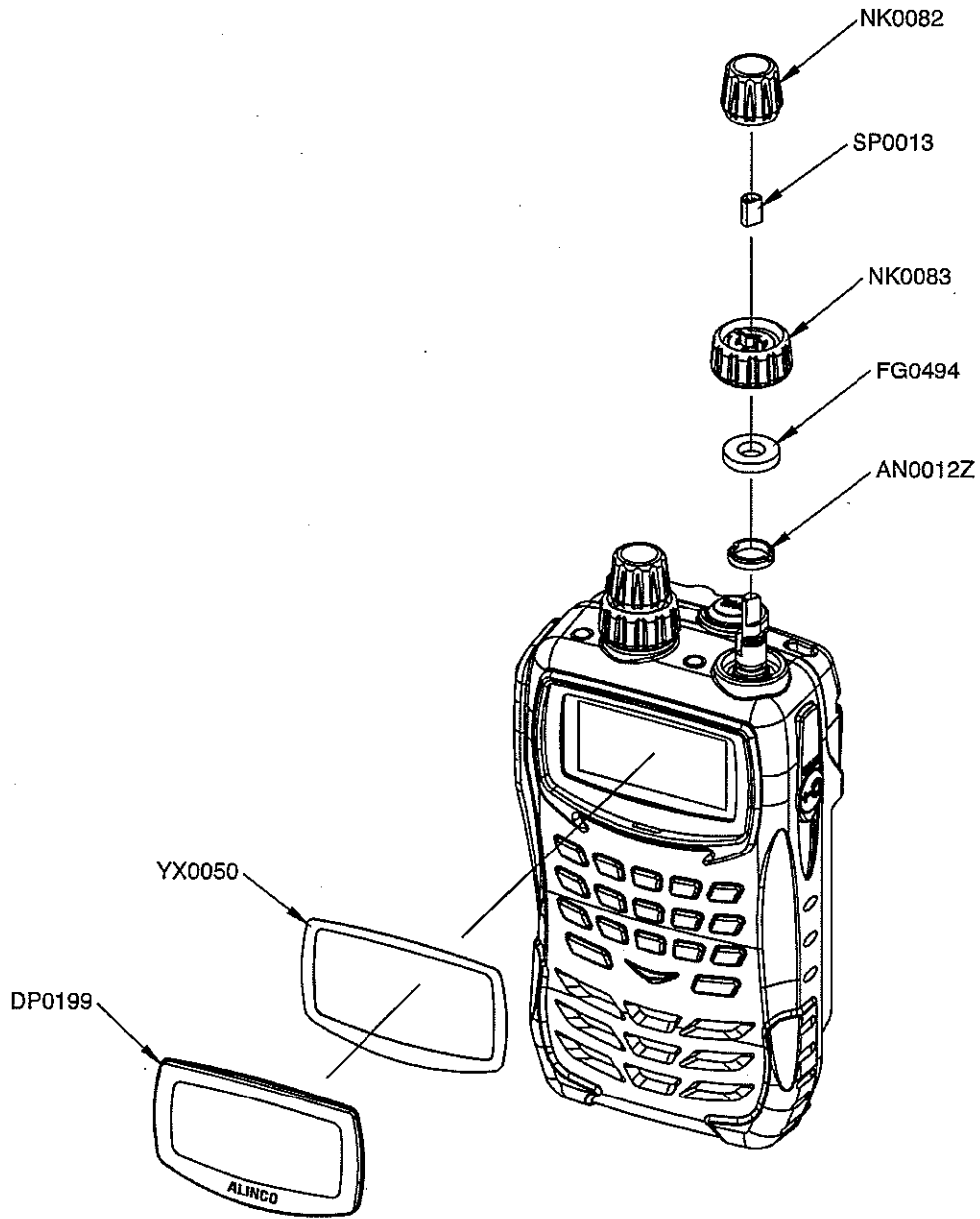

Push the all edge strongly.

1) Front View (2)

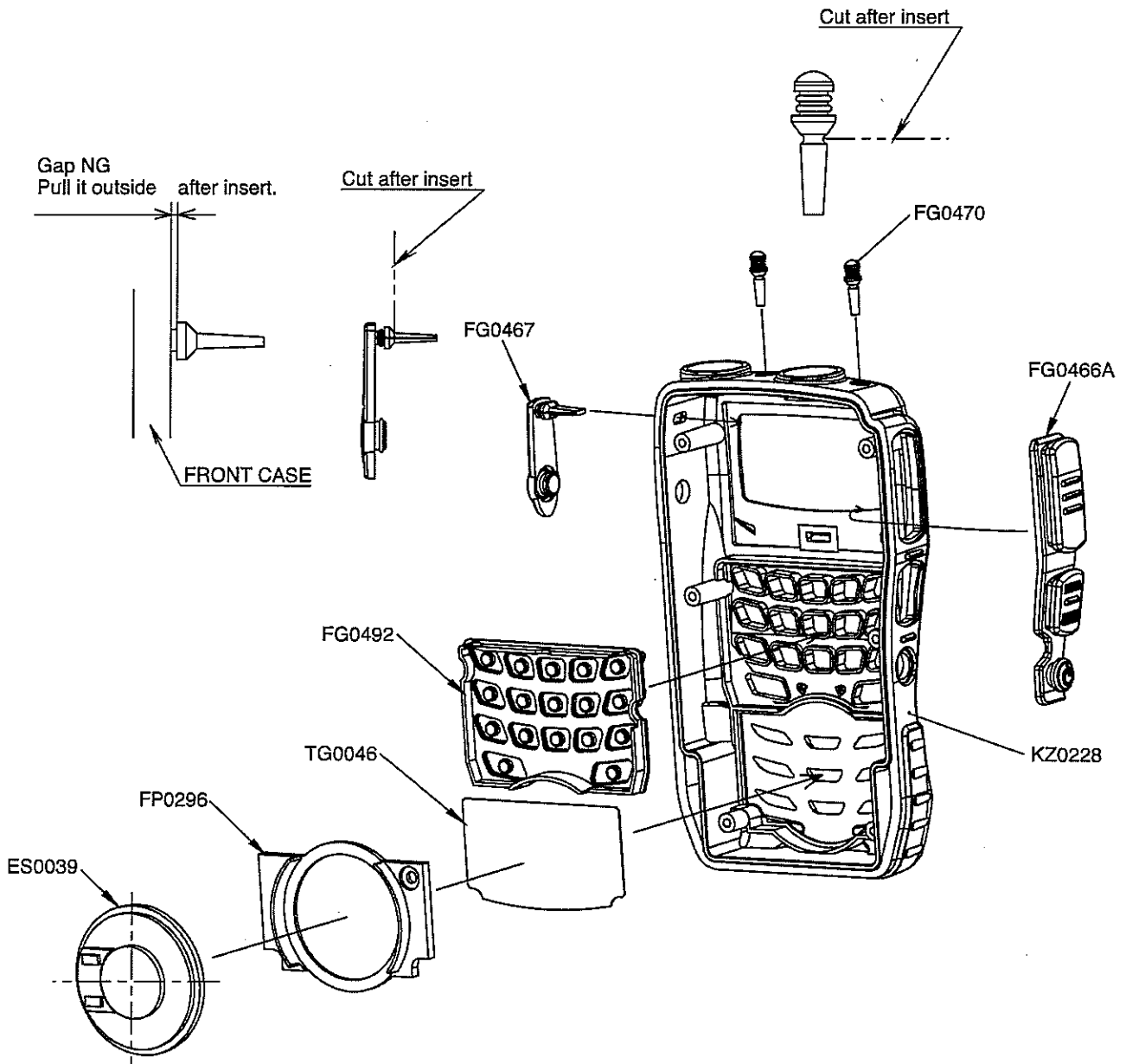

2) Rear View

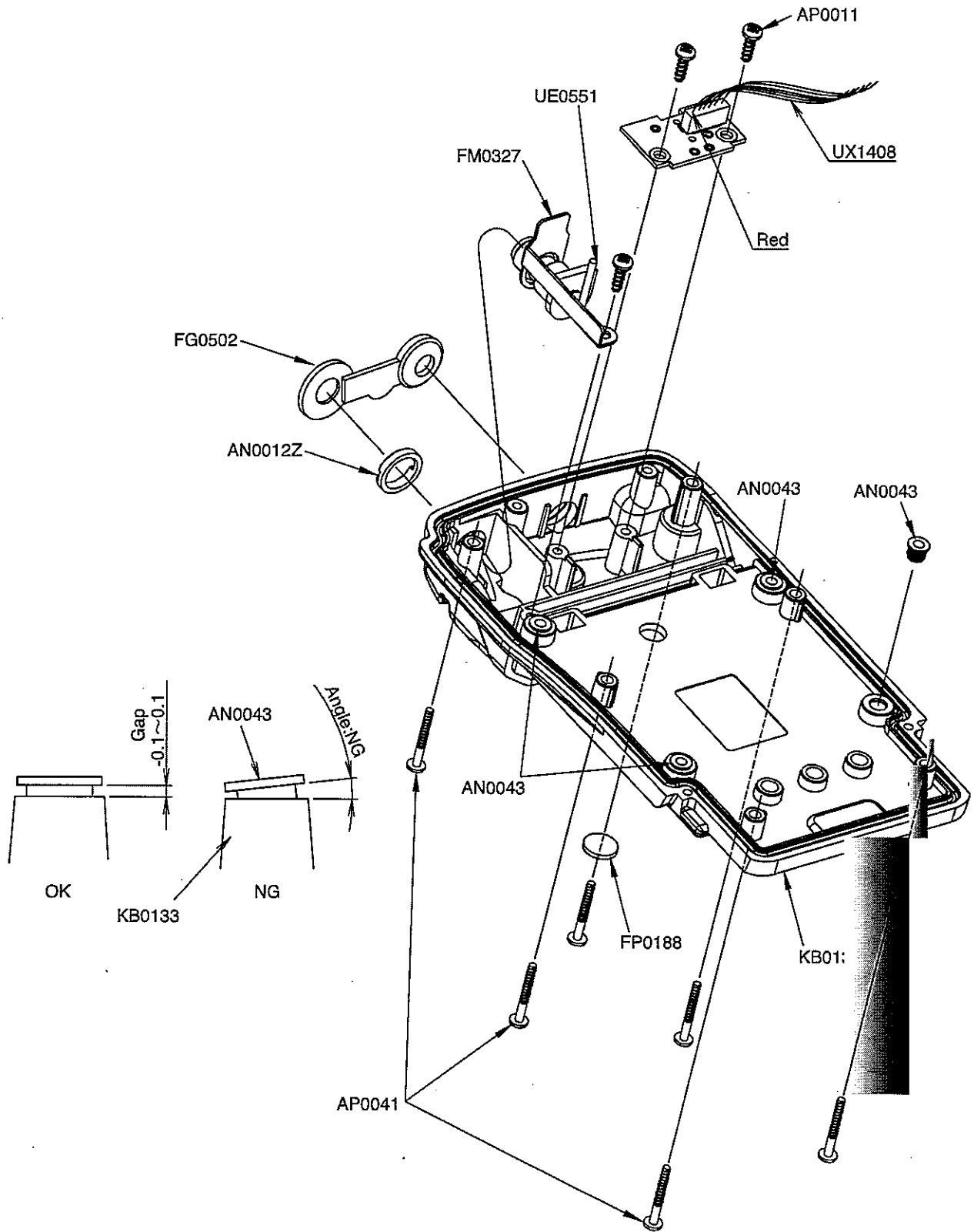

3) Bottom View

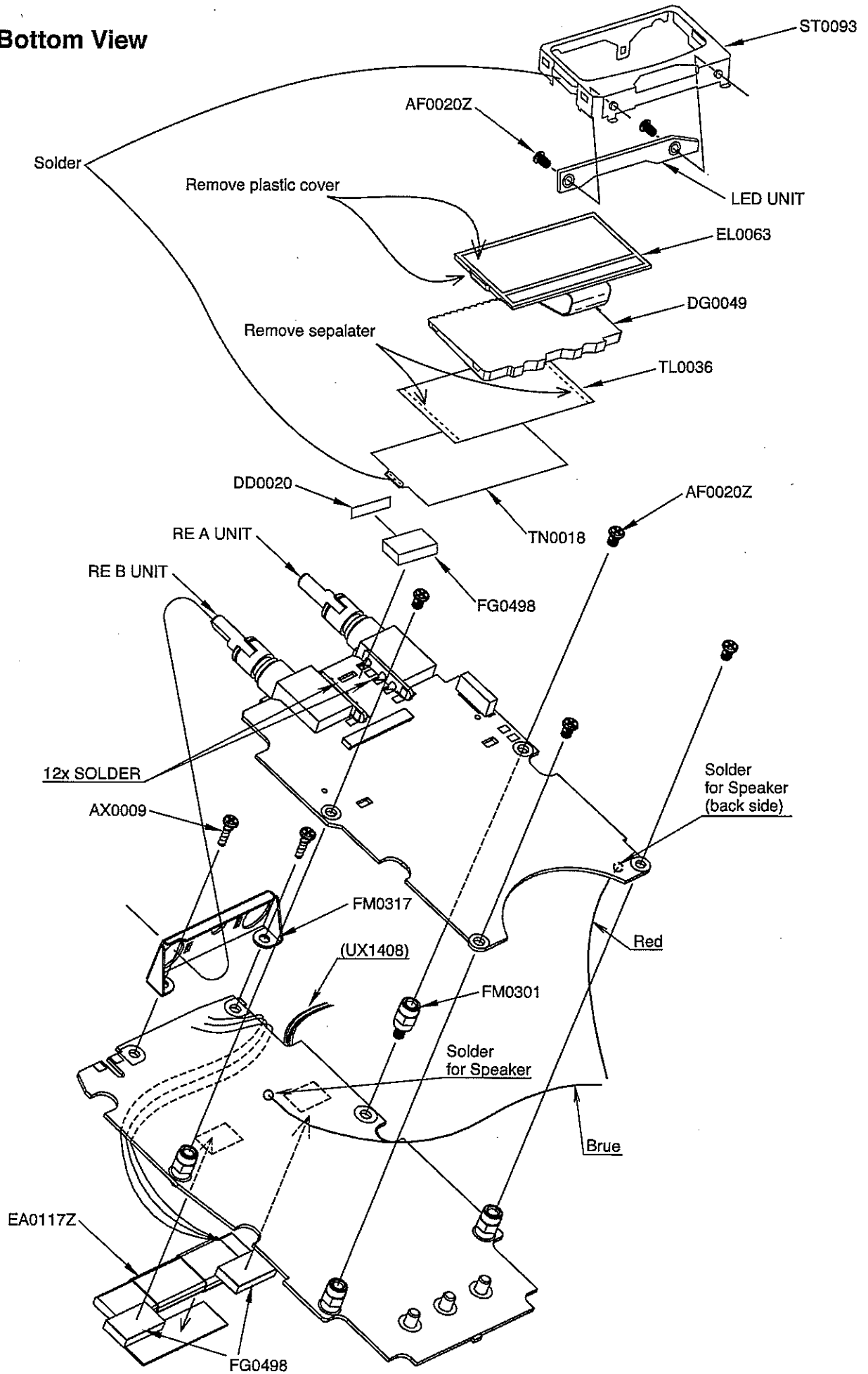

PARTS LIST

CPU Unit

Ref No.	Parts No.	Description	Parts Name	Version
	DG0049		LCD LIGHT	
	EL0063		G	
	ST0093		LCD HOLDER	
	TL0036		REFLECTIV SHEET	
	TN0018		SHIELD TAPE	
	UP0664		INTEGRATED	
C501	CS0431	Chip Tantalum	10V 2.2UF	
C502	CU3542	Chip C	GRM36B392K50PT	
C503	CU3554	Chip C	GRM36B104K10PT	
C504	CS0453	Chip Tantalum	TMCP0J226MTRF	
C505	CU3547	Chip C	GRM36B103K16PT	
C506	CU3559	Chip C	GRM155B30J105KE18D	
C507	CU3547	Chip C	GRM36B103K16PT	
C508	CU3542	Chip C	GRM36B392K50PT	
C509	CU3553	Chip C	GRM36B473K10PT	
C510	CU3554	Chip C	GRM36B104K10PT	
C511	CU3552	Chip C	GRM36B333K10PT	
C512	CU3559	Chip C	GRM155B30J105KE18D	
C513	CU3559	Chip C	GRM155B30J105KE18D	
C514	CU3554	Chip C	GRM36B104K10PT	
C515	CU3552	Chip C	GRM36B333K10PT	
C516	CU3559	Chip C	GRM155B30J105KE18D	
C517	CU3559	Chip C	GRM155B30J105KE18D	
C518	CU3559	Chip C	GRM155B30J105KE18D	
C520	CU3559	Chip C	GRM155B30J105KE18D	
C521	CU3554	Chip C	GRM36B104K10PT	
C522	CU3535	Chip C	GRM36B102K50PT	
C523	CU3535	Chip C	GRM36B102K50PT	
C524	CU3554	Chip C	GRM36B104K10PT	
C525	CU3535	Chip C	GRM36B102K50PT	
C526	CU3535	Chip C	GRM36B102K50PT	
C527	CU3547	Chip C	GRM36B103K16PT	
C528	CU3559	Chip C	GRM155B30J105KE18D	
C529	CU3523	Chip C	GRM1552C1H101JZ01D	
C530	CU3547	Chip C	GRM36B103K16PT	
C531	CU3544	Chip C	GRM36B562K25PT	
C532	CU3525	Chip C	GRM1552C1H151JD01D	
C533	CU3559	Chip C	GRM155B30J105KE18D	
C534	CU3535	Chip C	GRM36B102K50PT	
C535	CU3547	Chip C	GRM36B103K16PT	
C536	CS0451	Chip Tantalum	TMCP0G336MTR	
C537	CU3544	Chip C	GRM36B562K25PT	
C538	CU3544	Chip C	GRM36B562K25PT	
C539	CU3559	Chip C	GRM155B30J105KE18D	
C540	CU3559	Chip C	GRM155B30J105KE18D	
C541	CU3554	Chip C	GRM36B104K10PT	
C542	CS0451	Chip Tantalum	TMCP0G336MTR	
C543	CU3547	Chip C	GRM36B103K16PT	
C544	CU3547	Chip C	GRM36B103K16PT	
C545	CU3547	Chip C	GRM36B103K16PT	
C546	CU3547	Chip C	GRM36B103K16PT	
C547	CU3553	Chip C	GRM36B473K10PT	
C548	CU3554	Chip C	GRM36B104K10PT	
C549	CU3559	Chip C	GRM155B30J105KE18D	
C551	CU3559	Chip C	GRM155B30J105KE18D	
C552	CU3559	Chip C	GRM155B30J105KE18D	
C553	CU3559	Chip C	GRM155B30J105KE18D	
C554	CU3559	Chip C	GRM155B30J105KE18D	
C555	CU3559	Chip C	GRM155B30J105KE18D	
C556	CU3559	Chip C	GRM155B30J105KE18D	
C557	CU3535	Chip C	GRM36B102K50PT	
C558	CU3535	Chip C	GRM36B102K50PT	
C559	CU3552	Chip C	GRM36B333K10PT	
C560	CU3559	Chip C	GRM155B30J105KE18D	
C561	CU3554	Chip C	GRM36B104K10PT	
C562	CU3552	Chip C	GRM36B333K10PT	
C563	CU3559	Chip C	GRM155B30J105KE18D	
C564	CU3559	Chip C	GRM155B30J105KE18D	
C565	CU3554	Chip C	GRM36B104K10PT	
C566	CU3547	Chip C	GRM36B103K16PT	
C567	CU3547	Chip C	GRM36B103K16PT	
C568	CU3547	Chip C	GRM36B103K16PT	
C569	CU3547	Chip C	GRM36B103K16PT	
C570	CU3535	Chip C	GRM36B102K50PT	
C571	CU3535	Chip C	GRM36B102K50PT	
C572	CS0453	Chip Tantalum	TMCP0J226MTRF	
C573	CU3535	Chip C	GRM36B102K50PT	
C574	CU3535	Chip C	GRM36B102K50PT	
C575	CU3547	Chip C	GRM36B103K16PT	
C576	CS0453	Chip Tantalum	TMCP0J226MTRF	
C577	CU3554	Chip C	GRM36B104K10PT	
C578	CU3547	Chip C	GRM36B103K16PT	
C579	CU3523	Chip C	GRM1552C1H101JZ01D	
C580	CU3544	Chip C	GRM36B562K25PT	
C581	CU3525	Chip C	GRM1552C1H151JD01D	
C583	CU3535	Chip C	GRM36B102K50PT	

Ref No.	Parts No.	Description	Parts Name	Version
C584	CU3547	Chip C	GRM36B103K16PT	
C585	CS0451	Chip Tantalum	TMCP0G336MTR	
C586	CU3544	Chip C	GRM36B562K25PT	
C588	CU3559	Chip C	GRM155B30J105KE18D	
C589	CU3547	Chip C	GRM36B103K16PT	
C590	CU3559	Chip C	GRM155B30J105KE18D	
C591	CU3559	Chip C	GRM155B30J105KE18D	
C592	CU3554	Chip C	GRM36B104K10PT	
C593	CU3554	Chip C	GRM36B104K10PT	
C598	CU3559	Chip C	GRM155B30J105KE18D	
C599	CU3559	Chip C	GRM155B30J105KE18D	
C600	CS0427	Chip Tantalum	6.3V10UF	
C601	CU3535	Chip C	GRM36B102K50PT	
C602	CU3535	Chip C	GRM36B102K50PT	
C604	CU3535	Chip C	GRM36B102K50PT	
C605	CU3544	Chip C	GRM36B562K25PT	
C609	CS0427	Chip Tantalum	6.3V10UF	
C613	CS0427	Chip Tantalum	6.3V10UF	
C620	CU3559	Chip C	GRM155B30J105KE18D	
C621	CU3559	Chip C	GRM155B30J105KE18D	
C622	CU3547	Chip C	GRM36B103K16PT	
C624	CU3554	Chip C	GRM36B104K10PT	
C626	CS0466	Chip Tantalum	TMCA0J107MTRF	
C628	CS0466	Chip Tantalum	TMCA0J107MTRF	
C629	CU3515	Chip C	GRM36CH220J50PT	
C630	CU3515	Chip C	GRM36CH220J50PT	
C631	CU3535	Chip C	GRM36B102K50PT	
C632	CS0466	Chip Tantalum	TMCA0J107MTRF	
C633	CU3554	Chip C	GRM36B104K10PT	
C634	CS0455	Chip Tantalum	TMCMB1A107MTRF	
C635	CU3554	Chip C	GRM36B104K10PT	
C636	CS0455	Chip Tantalum	TMCMB1A107MTRF	
C637	CU3554	Chip C	GRM36B104K10PT	
C638	CU3554	Chip C	GRM36B104K10PT	
C639	CU3523	Chip C	GRM1552C1H101JZ01D	
C640	CU3559	Chip C	GRM155B30J105KE18D	
C641	CU3535	Chip C	GRM36B102K50PT	
C642	CU3554	Chip C	GRM36B104K10PT	
C643	CU3559	Chip C	GRM155B30J105KE18D	
C644	CS0397	Chip Tantalum	16V 1UF	
C645	CU3547	Chip C	GRM36B103K16PT	
CN501	UE0592	Connector	BM08B-SURS-TF	
CN502	UE0591	Connector	AXK6540647YG	
D503	XD0496	Dhip Diode	DA221MT2L	
D504	XD0484	Dhip Diode	RB521CS-30T2R	
D505	XD0484	Dhip Diode	RB521CS-30T2R	
D506	XD0496	Dhip Diode	DA221MT2L	
D507	XD0484	Dhip Diode	RB521CS-30T2R	
D508	XL0116	Dhip LED	BRPY1211F	
D509	XL0116	Dhip LED	BRPY1211F	
D510	XD0484	Dhip Diode	RB521CS-30T2R	
D511	XL0128	Dhip LED	SML-D12M8WT86	
D512	XL0128	Dhip LED	SML-D12M8WT86	
D513	XL0128	Dhip LED	SML-D12M8WT86	
D514	XL0128	Dhip LED	SML-D12M8WT86	
D515	XL0128	Dhip LED	SML-D12M8WT86	
D516	XL0128	Dhip LED	SML-D12M8WT86	
D518	XD0484	Dhip Diode	RB521CS-30T2R	
D519	XD0396	Dhip Diode	VDZ2R 3.9B	
IC501	XA1405	IC	LTC6904IMS8#TRPBF	
IC502	XA1355	IC	NJM12904RB1-TE1	
IC503	XA1355	IC	NJM12904RB1-TE1	
IC504	XA1355	IC	NJM12904RB1-TE1	
IC505	XA0995	IC	NJM2594V TE1	
IC506	XA1355	IC	NJM12904RB1-TE1	
IC507	XA1355	IC	NJM12904RB1-TE1	
IC510	XA0348	IC	TC4W53FU(TE12L)	
IC511	XA1406	IC	M30627FJPGP#U5C	K,E,EGR
IC511	XA1453	IC	M30627FJPGP#U5C	T
IC512	XA1186	IC	SM6451B	
IC514	XA0348	IC	TC4W53FU(TE12L)	
IC515	XA0210	IC	IC NJM2070M	
IC516	XA0833	IC	S812C30AMC-C2K-T2	
IC517	XA1351	IC	AT24C1024-TH-B	
IC518	XA1426	IC	BD4928FVE-TR	
L502	QC0507	Chip Inductor	LK16081R0K-T	
L503	QC0510	Chip Inductor	LK1608330M-T	
L506	QC0510	Chip Inductor	LK1608330M-T	
LCDS01	UE0587	Connector	FH33-30S-0.5SH	
Q501	XE0081	Chip FET	RTR040N03	
Q502	XU0210	Chip Transistor	RN1107FV	
Q503	XU0210	Chip Transistor	RN1107FV	
Q504	XU0210	Chip Transistor	RN1107FV	
Q505	XU0210	Chip Transistor	RN1107FV	
Q506	XT0214	Chip Transistor	HN2C01FE-GR(T5L,F)	
Q507	XT0214	Chip Transistor	HN2C01FE-GR(T5L,F)	

Mecanical Unit

Ref No.	Parts No.	Description	Parts Name	Version
	AF0020Z		OPH M2+3 FE/N 1	
	AN0012Z		RND M7X0.75 DR/BN	
	AN0043		INSERT FB2001	
	AP0011		PH P2+5 FE/B.ZN	
	AP0041		BIND P 2+15-10 BC	
	AP0042		BIND P 2+10-6 BC	
	AX0009		OPH P2+6 FE/N 1	
	DD0020		BLIND SHEET A	
	DP0199		LCD PANEL	
	EA0117Z		EA0117Z	
	ES0039		32-88B-10P	
	FG0466A		PTT RUBBER	
	FG0467		DC CAP	
	FG0470		ON AIR RUBBER	
	FG0492		KEY BOAD X11	
	FG0494		ANT CAP	
	FG0498		CUSHION	
	FG0502		JACK CAP	
	FM0301		6NUT L6.1 M2+3	
	FM0317		VOL CHASSIS	
	FM0327		ANT.GND DJX11	
	FP0188		JACK PANEL DR135	
	FP0296		SP BASE	
	KB0133		REAR CASE	
	KZ0228		FRONT CASE ASSY	
	NK0082		VOL KNOB	
	NK0083		SQL KNOB	
	SP0013		KNOB SPRING #7800	
	TG0046		SP NET DJG7	
	UE0551		SMA ANT CONNECTOR	
	YX0025		ANT. TAPE	
	YX0050		LCD TAPE	

Packing Unit

Ref No.	Parts No.	Description	Parts Name	Version
	EA0154		ANT. EA154	
	BH0020A		Belt-clip unit	
	#G1500		HAND STRAP ASSY	
	#G1646		EDC174 P VAG	
	#G1644		EDH-36 P BAG	
	EG0074		EBP-74 P BAG	
	FM0324		LOCK LEVER	
	EDC-140		AC ADAPTOR	
	PS0612		INSTRUCTION DJX11T	
	PR0514		E-10x49 LABEL(W)	
	DS0446		SPEC SHEET	
	PR0478		SERIAL SEAL	
	HK0713		Individual Box DJX11	
	HU0270		INNER MAIN	
	HU0271		INNER SIDE	
	HMQ250		10-CARTON BOX	
	HU0246		10-INNER	
	HPO031		P BAG	

ADJUSTMENT

Adjustment Mode

How to enter the Adjustment mode

After Key lock, Push 3→1→2→3→2→1

- After adjust each item, Press the V/P/M Key.
- When want to change the display, press the MAIN key or SUB key

Adjustment Points

SQL : After push the RE, Rotate the RE.

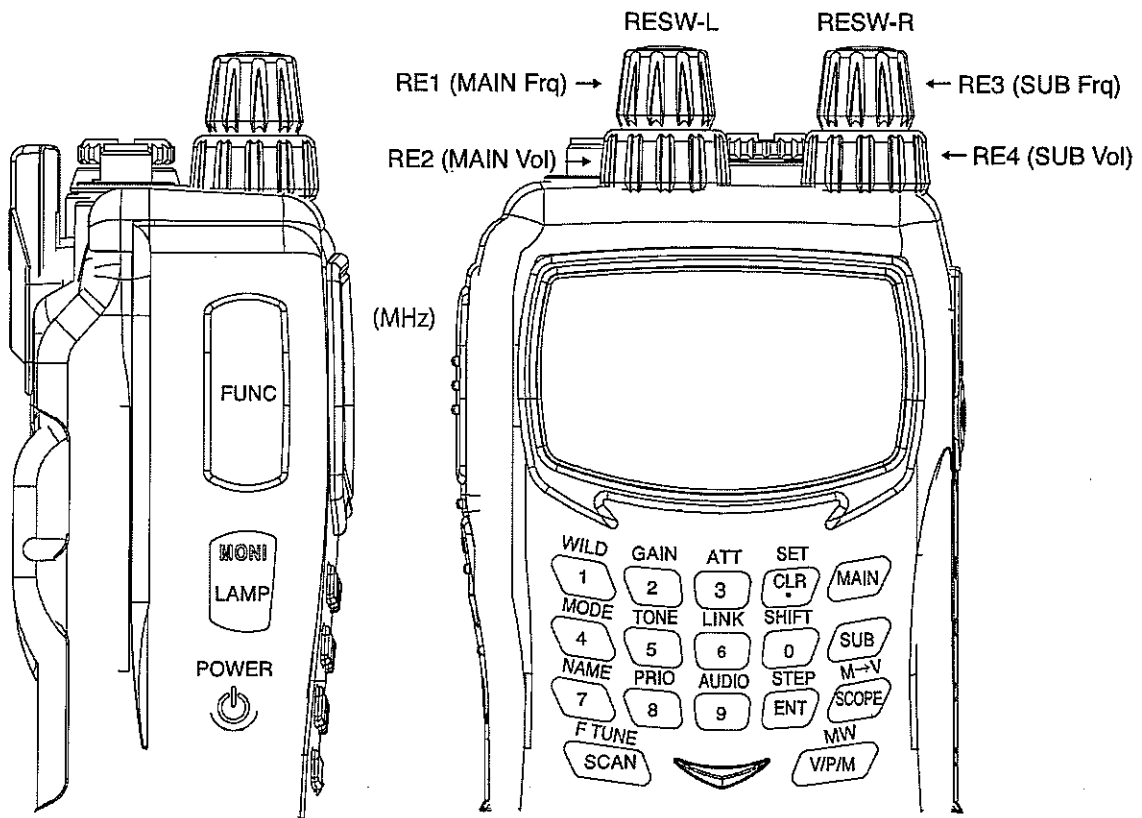

Power Supply : 6.0±0.1 V

Mod:Frequency : 1KHz

Dev : FM 3.5KHz/ AM 30%/ WFM 50.5KHz

	Item	Display	Spec	Display Frq	Adj Key
0	Aging	AGING	Automatic operation		V/P/M Key
1	BFO (USB)	USB	456.5KHz \pm 300Hz	7.105MHz	RE3 TP518
2	BFO (LSB)	LSB	453.5KHz \pm 300Hz	7.105MHz	RE3 TP518
3	Ref Freq	FrEq	339.56MHz \pm 200Hz	435.17MHz	RE3 TP101
4	3rd Lo AM L Freq	TVCXO	44.60495MHz \pm 100Hz	7.1MHz	RE3 TP109
5	3rd Lo AM M Freq	MVCXO	44.600MHz \pm 100Hz	7.105MHz	RE3 TP109
6	3rd Lo AM H Freq	BVCXO	44.595MHz \pm 100Hz	7.11MHz	RE3 TP109
13	Offset F Counter	Fadj	1.5GHz No Mod 100dBu	1.5GHz	V/P/M Key
14	M SQL 1 Adj (MBF1)	MSQL 1L	NFM -14dBu	25.17MHz	V/P/M Key
15	M SQL 9 Adj (MBF1)	MSQL 1H	NFM -6dBu	25.17MHz	V/P/M Key
16	M SQL 1 Adj (MBF2)	MSQL 2L	NFM -14dBu	70.17MHz	V/P/M Key
17	M SQL 9 Adj (MBF2)	MSQL 2H	NFM -6dBu	70.17MHz	V/P/M Key
18	M SQL 1 Adj (MBF3)	MSQL 3L	NFM -14dBu	145.17MHz	V/P/M Key
19	M SQL 9 Adj (MBF3)	MSQL 3H	NFM -6dBu	145.17MHz	V/P/M Key
20	S SQL 1 Adj (SBF3)	SSQL VL	NFM -14dBu	145.17MHz	V/P/M Key
21	S SQL 9 Adj (SBF3)	SSQL VH	NFM -6dBu	145.17MHz	V/P/M Key
22	S SMT Min Adj (NFM)	SSMT VL	NFM -5dBu	145.17MHz	V/P/M Key
23	S SMT Max Adj (NFM)	SSMT VH	NFM 14dBu	145.17MHz	V/P/M Key
24	M SQL 1 Adj (MBF4)	MSQL 4L	NFM -10dBu	225.17MHz	V/P/M Key
25	M SQL 9 Adj (MBF4)	MSQL 4H	NFM -2dBu	225.17MHz	V/P/M Key
26	M SQL 1 Adj (MBF5)	MSQL 5L	NFM -13dBu	435.17MHz	V/P/M Key
27	M SQL 9 Adj (MBF5)	MSQL 5H	NFM -5dBu	435.17MHz	V/P/M Key
28	M SMT Min Adj (NFM)	MSMT NL	NFM -5dBu	435.17MHz	V/P/M Key
29	M SMT Max Adj (NFM)	MSMT NH	NFM 14dBu	435.17MHz	V/P/M Key
30	S SQL 1 Adj (SBF5)	SSQL UL	NFM -13dBu	435.17MHz	V/P/M Key
31	S SQL 9 Adj (SBF5)	SSQL UH	NFM -5dBu	435.17MHz	V/P/M Key
32	S SMT Min Adj (NFM)	SSMT NL	NFM -5dBu	435.17MHz	V/P/M Key
33	S SMT Max Adj (NFM)	SSMT NH	NFM 14dBu	435.17MHz	V/P/M Key
34	M SQL 1 Adj (MBF6)	MSQL 6L	NFM -7dBu	767.17MHz	V/P/M Key
35	M SQL 9 Adj (MBF6)	MSQL 6H	NFM 1dBu	767.17MHz	V/P/M Key
36	M SQL 1 Adj (MBF7)	MSQL 7L	NFM -7dBu	1280.17MHz	V/P/M Key
37	M SQL 9 Adj (MBF7)	MSQL 7H	NFM 1dBu	1280.17MHz	V/P/M Key

No4~No6 must be used the jig.

	Item	Display	Spec	Display Frq	Adj Key
38	M SQL 1 Adj (AM)	MSQL AL	AM 10dBu-	119.17MHz	V/P/M Key
39	M SQL 9 Adj (AM)	MSQL AH	AM -2dBu	119.17MHz	V/P/M Key
40	M SMT Min Adj (AM)	MSMT AL	AM 4dBu	119.17MHz	V/P/M Key
41	M SMT Max Adj (AM)	MSMT AH	AM 13dBu	119.17MHz	V/P/M Key
42	S SQL 1 Adj (AM)	SSQL AL	AM -10dBu	119.17MHz	V/P/M Key
43	S SQL 9 Adj (AM)	SSQL AH	AM -2dBu	119.17MHz	V/P/M Key
44	S SMT Min Adj (AM)	SSMT AL	AM 6dBu	119.17MHz	V/P/M Key
45	S SMT Max Adj (AM)	SSMT AH	AM 14dBu	119.17MHz	V/P/M Key
46	M SQL 1 Adj (WFM)	MSQL WL	WFM -7dBu	84.5MHz	V/P/M Key
47	M SQL 9 Adj (WFM)	MSQL WH	WFM 1dBu	84.5MHz	V/P/M Key
48	M SMT 1 Adj (WFM)	MSMT WL	WFM 10dBu	84.5MHz	V/P/M Key
49	M SMT 9 Adj (WFM)	MSMT WH	WFM 25dBu	84.5MHz	V/P/M Key
50	Battery Display	DC IN	DC 6.0V	350.17MHz	V/P/M Key
51	Descrambling level	SCR	NFM 30dBu No strange sound	350.17MHz	RE3

No need to adjust No.51.(Descrambling level).

Finally press the FUNC key after finishing all adjustment items.

PC BOARD VIEW

CPU Unit Side A

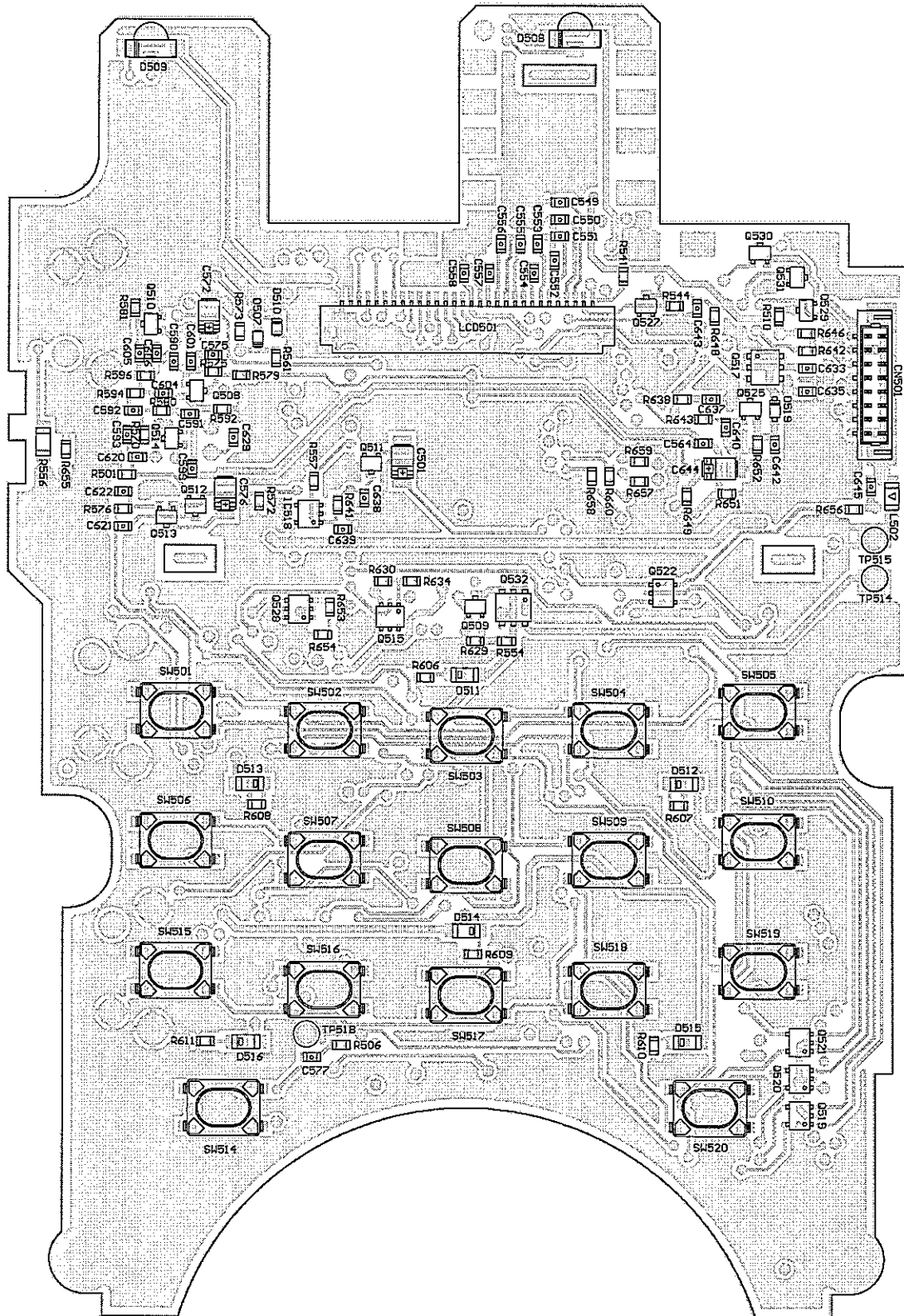

CPU Unit Side B

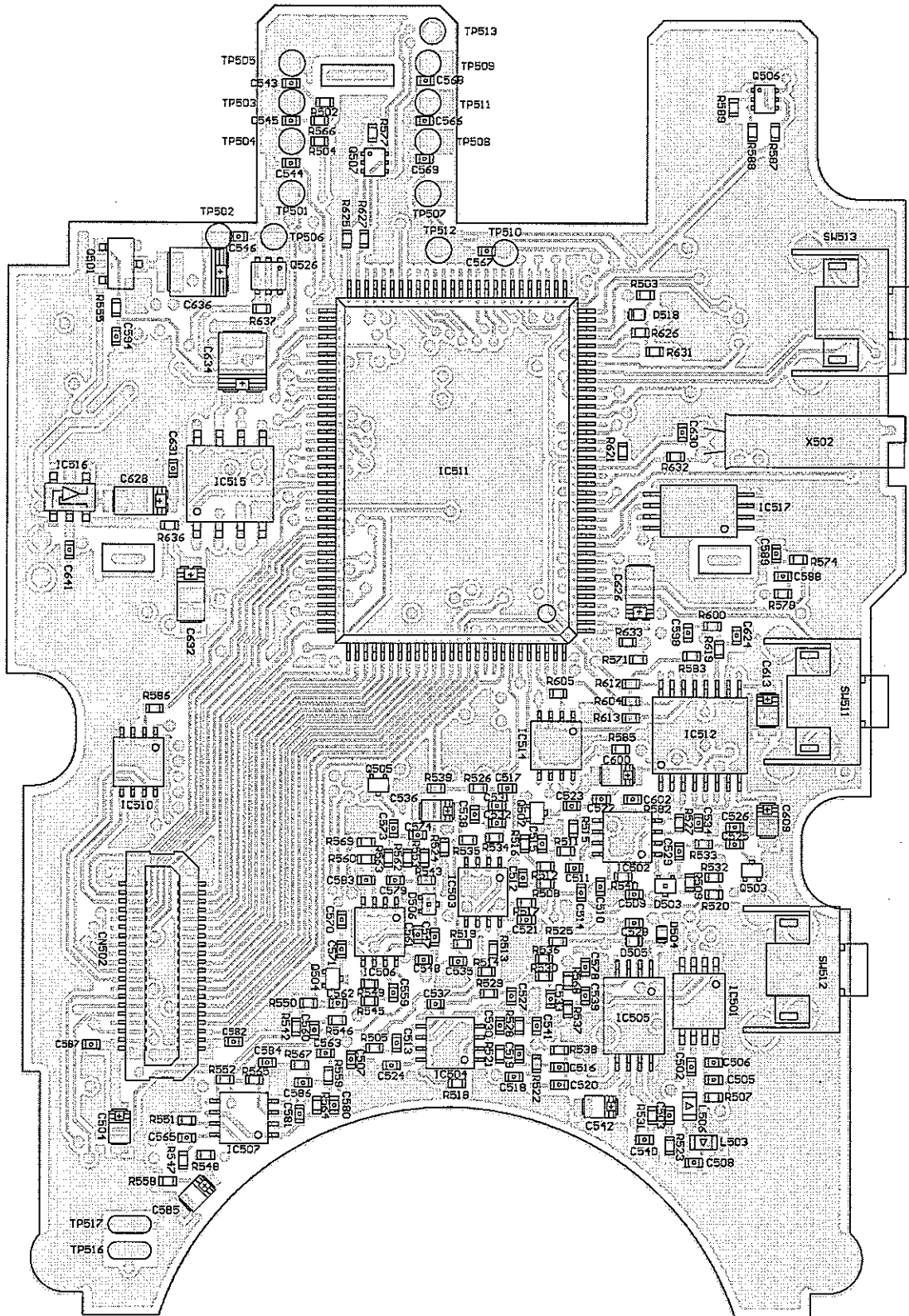

JACK UNIT
Side A

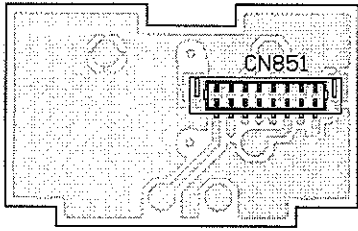

Side B

JK851

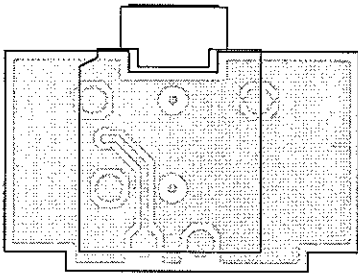

RE A UNIT
Side A

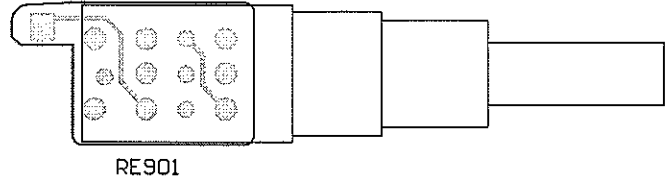

Side B

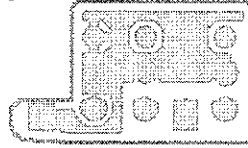

RE B UNIT
Side A

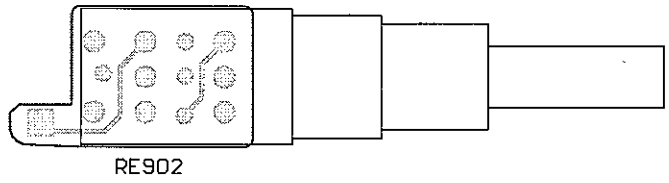

Side B



LED UNIT
Side A

REF .No

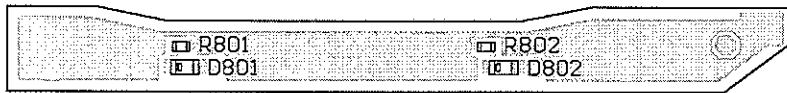

Side B



MAIN Unit Side A

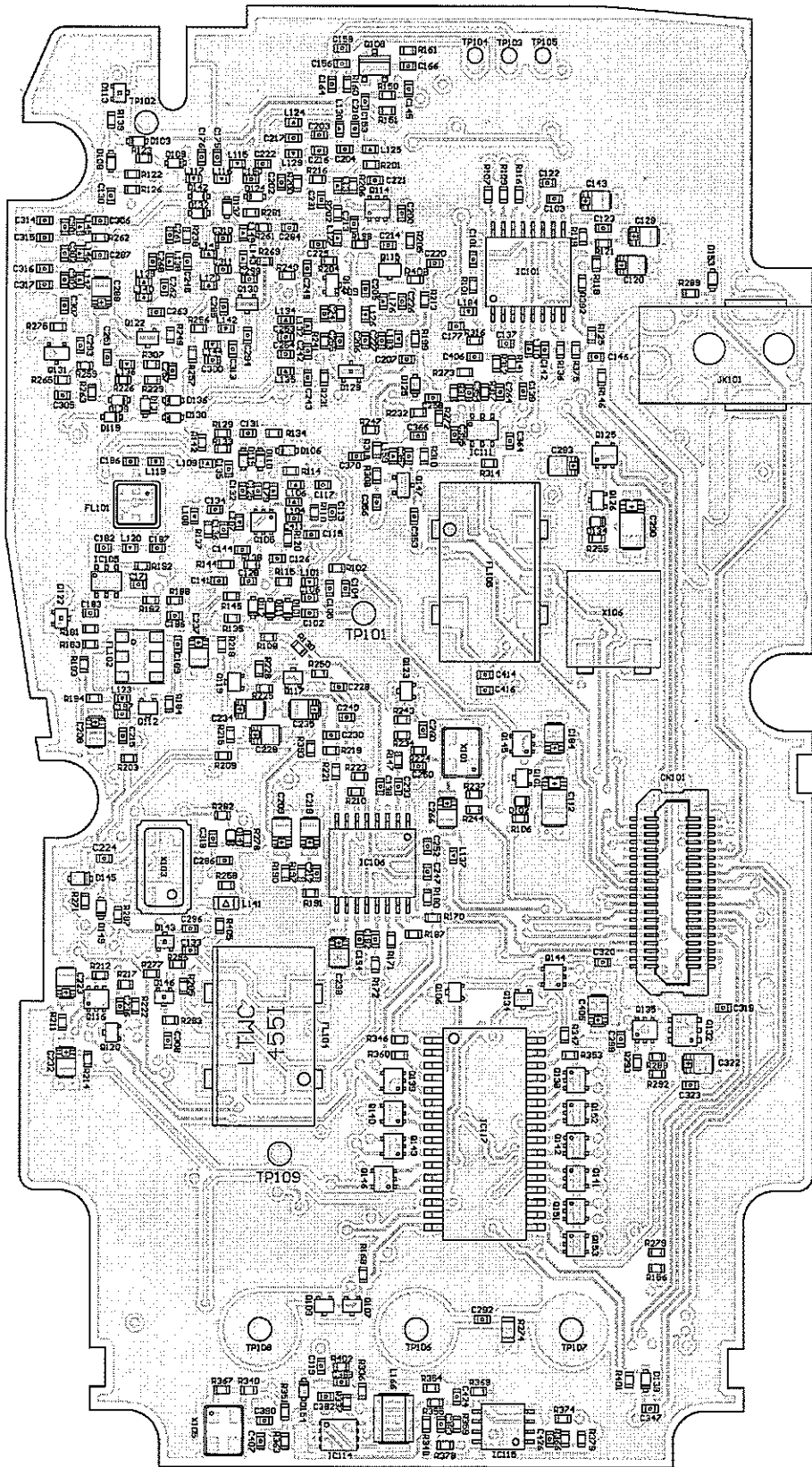

MAIN Unit Side B

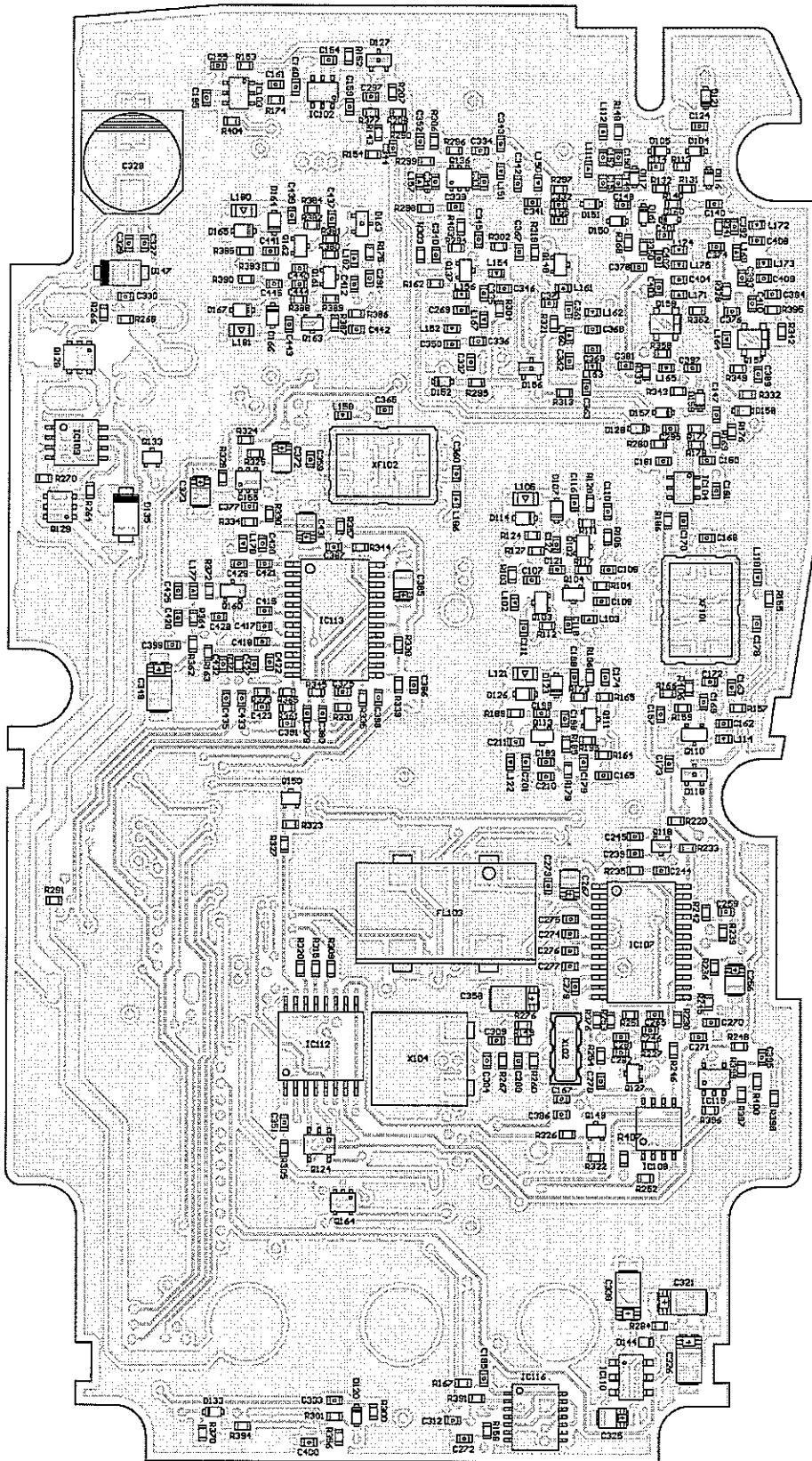

ALINCO,INC.

Head Office:Yodoyabashi-Dai building 13th Floor
4-9, 4-Chome, Koraihashi, Chuo-ku, Osaka 541-0043, JAPAN
Phone:+81-6-7636-2362 Fax:+81-6-6208-3802
<http://www.alinco.com>
E-mail:export@alinco.co.jp

Dealer/Distributor

BLOCK DIAGRAM

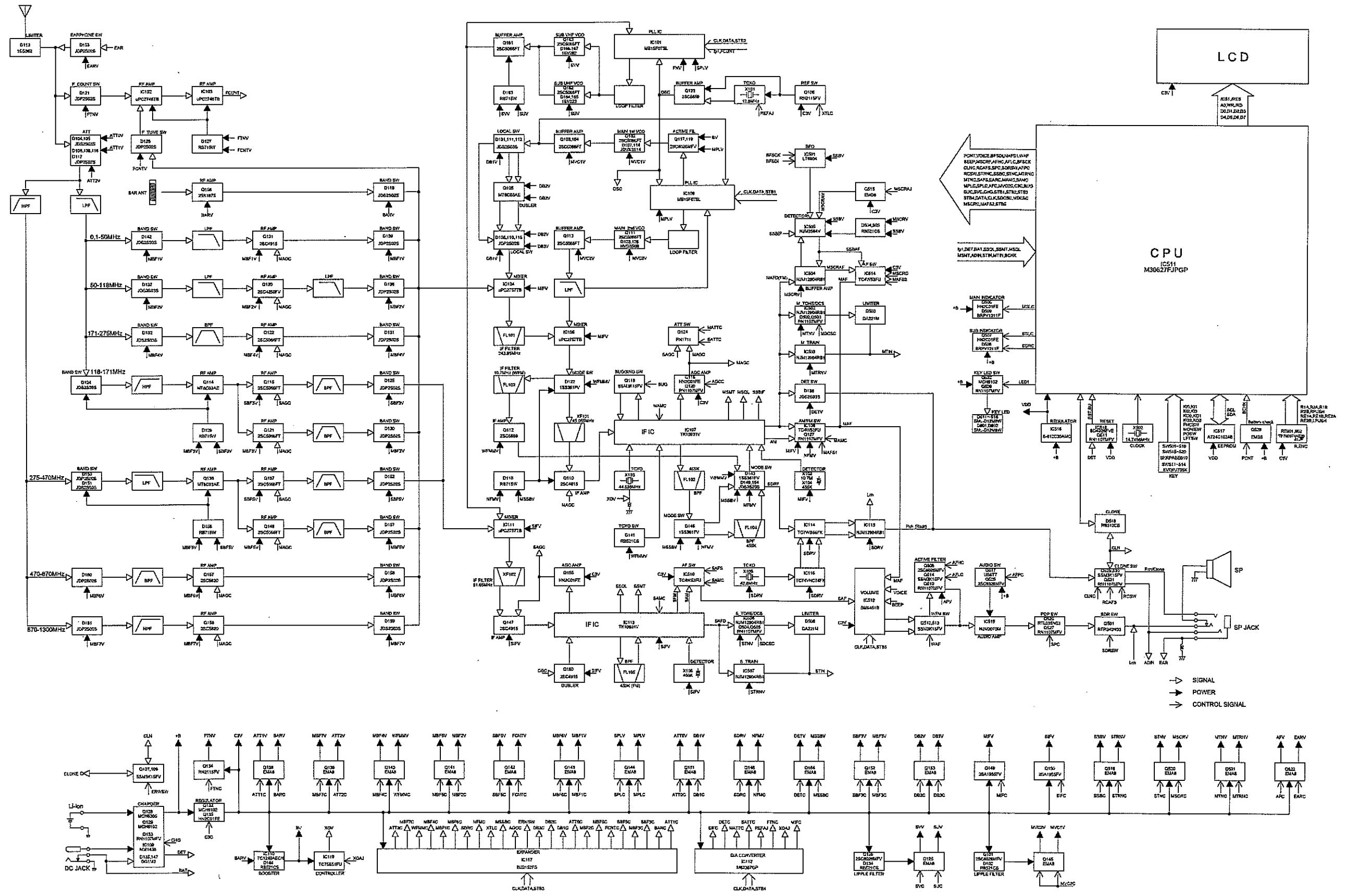

MAIN

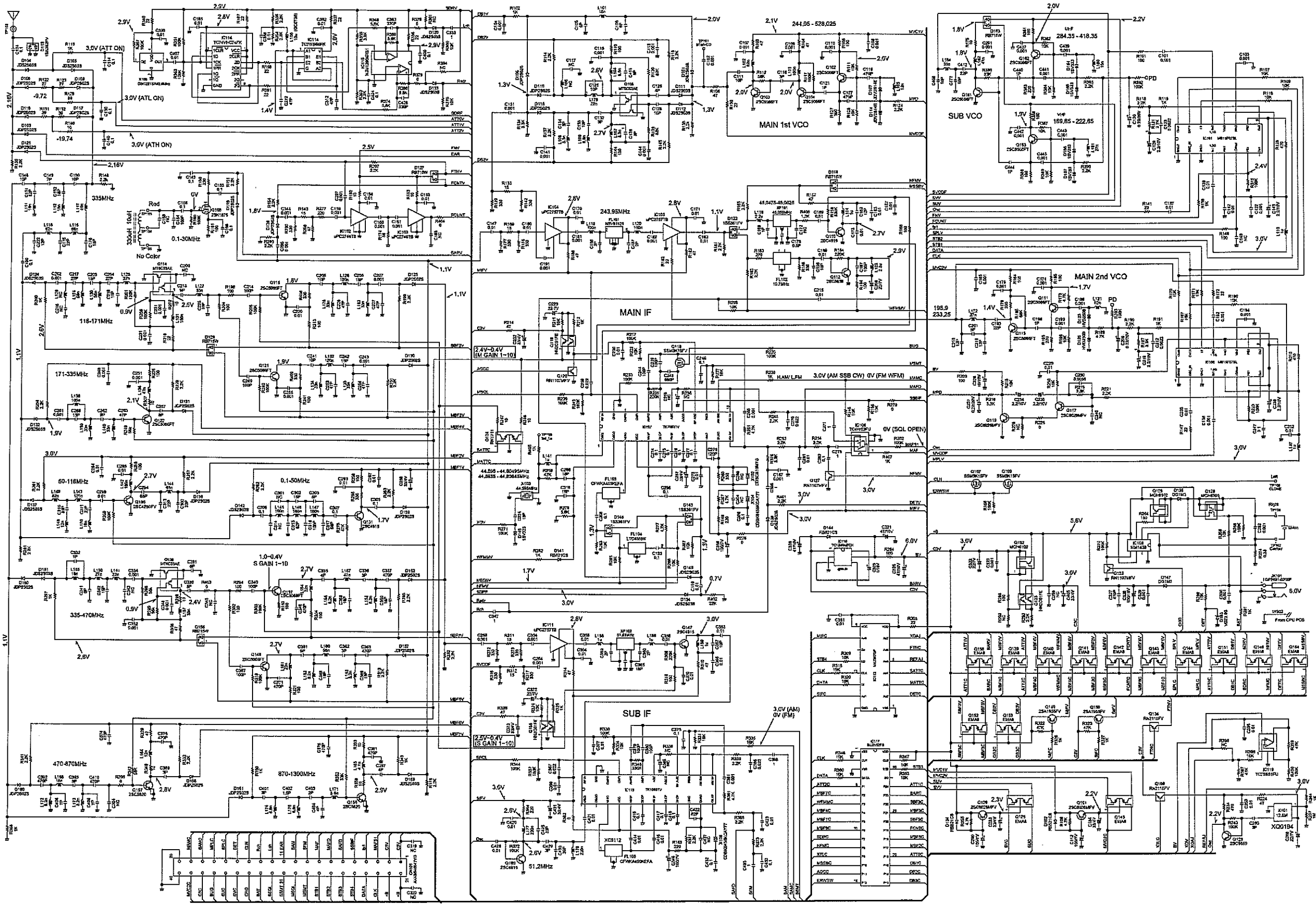

RE A Unit

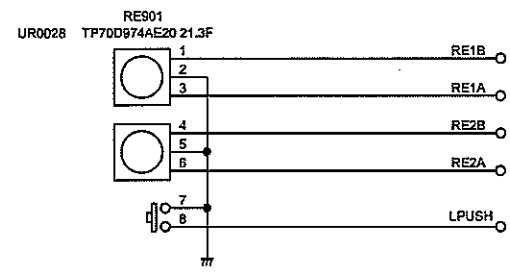

Led Unit

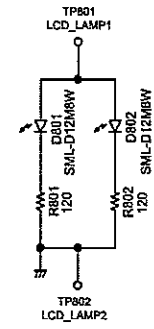

RE B Unit

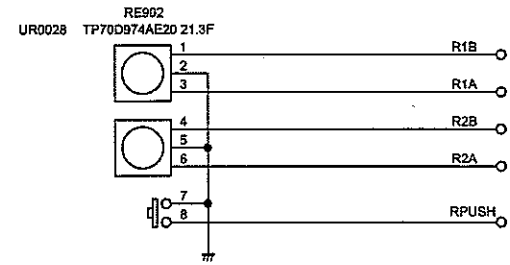

Jack Unit

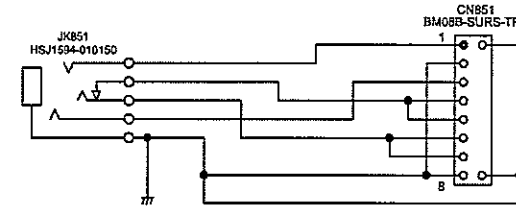

SCHEMATIC DIAGRAM

CPU

