



Control Knobs from **Cliff UK**



Cliff Electronic Components Limited

76 Holmethorpe Avenue,
Holmethorpe Industrial Estate,
Redhill, Surrey RH1 2PF. United Kingdom.

Tel: +44 (0)1737 771375

Fax: +44 (0)1737 766012

E-mail: sales@cliffuk.co.uk



Visit us online at:

www.cliffuk.co.uk

CLIFF



K1C

Chrome, Satin or colored discs available.
Base Diameter: 25.4
Overall height: 15.1
Shaft depth: 12



K3C / K4C

K3C - Matl Nylon
K4C - Matl Bakelite
Base Diameter: 19
Overall height: 13.7
Shaft depth: 11.4



K5

Marker line optional.

Base Diameter: 19.5
Overall height: 19.2
Shaft depth: 16



K6C

Base Diameter: 25.4
Overall height: 12
Shaft depth: 12



K6C/SKT

Skirts are plain, 0-5-0 or 0-10

Base Diameter: 41
Overall height: 14
Shaft depth: 10



K7C

Base Diameter: 19.1
Overall height: 16
Shaft depth: 14



K8

Marker dot on skirt is standard.

Base Diameter: 25.1
Overall height: 16.7
Shaft depth: 12



K85

8 cap colours available, sold separately.
Transparent model for encoder also available.
Base Diameter: 14
Overall height: 18
Shaft depth: 11.5



K85M

Two colour moulded.
Body and line / cap available in 8 colours.
Base Diameter: 14
Overall height: 17.8
Shaft depth: 12.5



K88

Skirtless version of K85. 8 cap colours.

Base Diameter: 12
Overall height: 18
Shaft depth: 11.5

All dimensions are approximate and in mm.

Drawings available on request. Contact sales@cliffuk.co.uk



K86R

2 colour moulded.
6 standard colours.
Soft touch finish.
Base Diameter: 16.0
Overall height: 15.0
Shaft depth: 12



K86AR

2 colour moulded.
6 standard colours.
Soft touch finish.
Base Diameter: 11.0
Overall height: 14.8
Shaft depth: 10



K87MA, K87MAR

2 colour moulded. 8 standard colours. Push fitting only. Integral cap, not removeable.
K87MA - Hard finish version.
K87MAR - Rubber (Soft touch) finish
Base Diameter: 16.8
Overall height: 14.5
Shaft depth: 12.8 (11.8 on 6mm SPL)

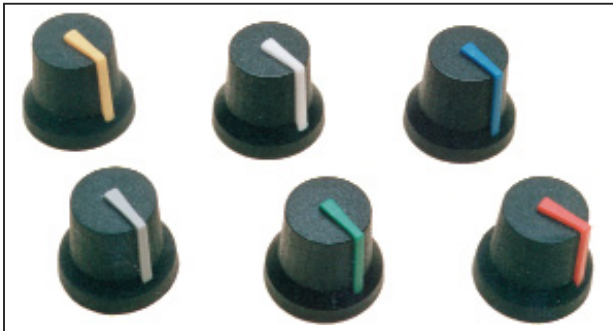

K87MB

2 colour moulded. 8 standard colours. Push fitting only.
K87MB - hard finish version.
K87MBR - Rubber (Soft touch) finish.
Base Diameter: 16.8
Overall height: 14.5
Shaft depth: 12.8 (11.8 on 6mm SPL)

Note: 2 colour moulded knobs may be subject to minimum production run quantities.



K9

Has a skirt / nut cover. 8 cap colours, ordered separately.
Base Diameter: 19.2
Overall height: 19
Shaft depth: 13.8



K10

Without skirt. Cap is same as K9
Base Diameter: 17
Overall height: 18.5
Shaft depth: 13



K11

Push in cap, 8 colours, ordered separately.
Base Diameter: 19.5
Overall height: 19
Shaft depth: 13.3
Collet type 7.2

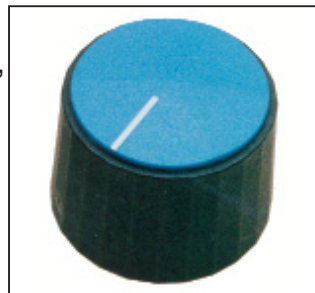

K12

Push in cap, 8 colours or skirt as K6 (glued on).
Base Diameter: 25.3
Overall height: 19.2
Shaft depth: 13.3
Collet type 7.2



K13

A range of knobs incorporate metal threads or threaded studs. Sizes range from M4 to M8. Threaded element is either brass (M4) or steel (M5 to M8). Knobs can be supplied unassembled. Due to the large number of possible variations, these knobs are made to order only. Standard colours are grey, black or red.

All dimensions are approximate and in mm.

For further information, contact sales@cliffuk.co.uk

CLIFF



K14

Aluminium clad plastic knob with diamond turned finish.
Base Diameter: 15
Overall height: 12.5
Shaft depth: 10



K15

Aluminium clad plastic knob with diamond turned finish.
Base Diameter: 20
Overall height: 13
Shaft depth: 12



K15P

Plastic version of K15 with matt textured top.
Base Diameter: 18.8
Overall height: 11.2
Shaft depth: 10



K16

Aluminium clad plastic knob with diamond turned finish.
Base Diameter: 30
Overall height: 15
Shaft depth: 12



K16P

Plastic version of K16 with matt textured top.
Base Diameter: 29
Overall height: 12.7
Shaft depth: 10



K17

Matt non reflective finish, prominent marker line, serrated edge.
Base Diameter: 29
Overall height: 12.9
Shaft depth: 10



K18

Encoder knob with fast and slow drive.
Available in 3 weights.
Base Diameter: 39.6
Overall height: 13.5
Shaft depth: 13.5



K19

Needs Ø16mm panel hole. 2 sizes.
K19A - Ø15mm
K19B - Ø13mm
Base Diameter: 16
Overall height: 17
Shaft depth: 13.4



C18

Cap is intergral, not removeable. Low cost version, all black is available.
Base Diameter: 19.3
Overall height: 16.3
Shaft depth: 15



C18/SKT

One piece knob and skirt. Integral cap. Skirt printed 0-10 or marker line.
Base Diameter: 27.8
Overall height: 15
Shaft depth: 13

All dimensions are approximate and in mm.

Drawings available on request. Contact sales@cliffuk.co.uk

CLIFF



KM12B

Knurled aluminium shell on plastic inner. Finish black anodised
Base Diameter: 12
Overall height: 12
Shaft depth: 10



KM15B

Knurled aluminium shell on plastic inner. Finish black anodised
Base Diameter: 15
Overall height: 15
Shaft depth: 14



KM20B - KM50B

Aluminium clad plastic knobs. The black anodised finish is relieved by bright diamond cut features. Knurled finish on the edge is standard. Various sizes from Ø20mm to Ø50mm. Push fix only. Optional marker line is diamond cut.
Base Diameter: 20mm to 50mm
Overall height: 17mm to 20mm
Shaft depth: 2mm less than knob height



KMR12 - KMR50

Aluminium clad plastic knobs with domed top. Smooth powder coated finish. Standard colours black or silver. Other colours subject to viable quantities. Various sizes Ø12mm to Ø50mm. Push fix only. Supplied in plastic trays.
Base Diameter: 12mm to 50mm
Overall height: 13mm to 25mm
Shaft depth: 2mm less than knob height

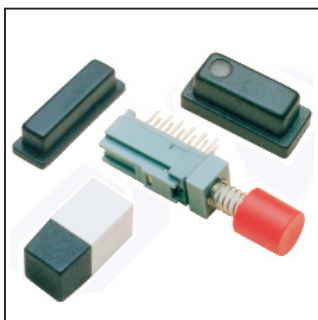

CUSTOM KNOBS AND BUTTONS

We can produce to you own designs. Sometimes we can make mould inserts for existing tooling to avoid the need to make new moulds. We have a number of semi-custom parts which can be available to any customers. Discuss any needs for non standard knobs or buttons with our Engineering department.

All dimensions in mm.

ORDERING INFORMATION

STANDARD COLOURS.

The colours shown below are for reference only and may not be identical to actual colours.



BLACK



RED



BLUE

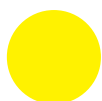

YELLOW



GREEN



ORANGE



GREY

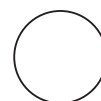

WHITE

Custom colours can be available for single or multi colour moulded knobs.

Knob caps can be supplied plain, with a marker line (ML), marker dot (MD) or custom legend.

[For further information, contact sales@cliffuk.co.uk](mailto:sales@cliffuk.co.uk)



SLIDER POTENTIOMETER KNOBS CS SERIES

Eight different designs are produced. 3 types have option of 4mm. 6/8mm shaft fitting. All knobs have matt non reflective finish to match our K9-K12 series and C18. Standard colour - Black. Electrically conductive models available.

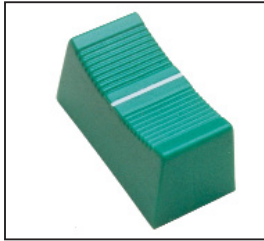

L 23mm, W 11mm, H 11mm

CS1 - for 6/8mm shaft
CS1A - for 4mm shaft
CS1B - fro 4mm shaft



L 27mm, W 16mm, H 7mm

CS9 - for 6/8mm shaft
CS9A - for 4mm shaft



L 17mm, W 10mm, H 8mm

CS8 - for 6/8mm shaft
smaller version of CS1



L 27mm, W 13mm, H 8mm

CS10 - for 6/8mm shaft
Narrower version of CS-9
CS10R - Soft touch version
Available in blk/white.

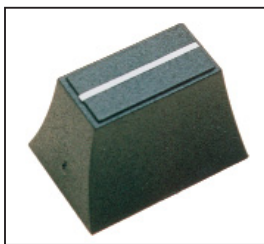

L 20mm, W 14mm, H 13mm

CS2 - for 6/8mm shaft
CS2A - for 4mm shaft
CS2B - for 4mm shaft



Diameter 8mm, Height 8mm
CS-11

Designed to fit square shaft
of push button switches and
4mm or 6mm slider shafts.

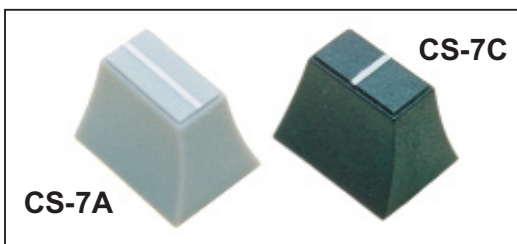

CS-7A

CS-7C

L 12mm, W 9mm, H 9mm

CS7A - for 4mm shaft

CS7C - for 4mm shaft



L 12mm, W 12mm, H 10mm
CS-12

Designed to fit 3.3mm shaft
of push button switches.

SHAFT DETAILS (TYPICAL)

4mm TYPE 'A' (std)

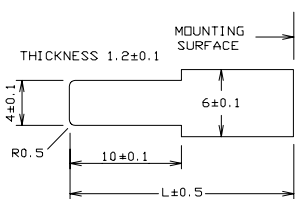

4mm TYPE 'B' (special)

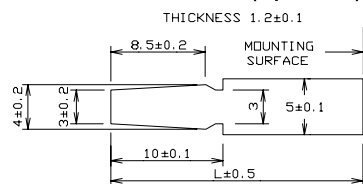

TYPE B subject to viable qty.

8mm TYPE

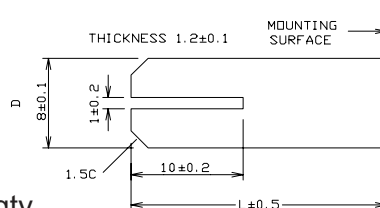

6mm TYPE

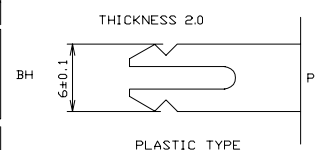

Note: Other colours or shaft fittings available subject to economical quantity.

Drawings available on request. Contact sales@cliffuk.co.uk



KNURLED ALUMINIUM SHELL KNOBS - KMK SERIES



Knobs for professional equipment - comprising machined aluminium shell on moulded plastic inner. Push on fixing. Max shaft depth 11mm.

KMK10

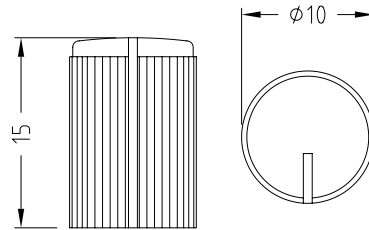
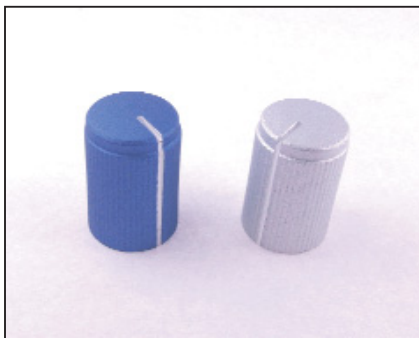

KMK10

6mm Splined shaft

FC7248 - Silver Anodised

FC7249 - Black Anodised

6mm USA 'D' shaft

FC7250 - Silver Anodised

FC7251 - Black Anodised

Other anodised colours available.

KMK25

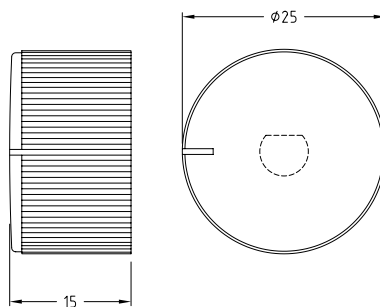
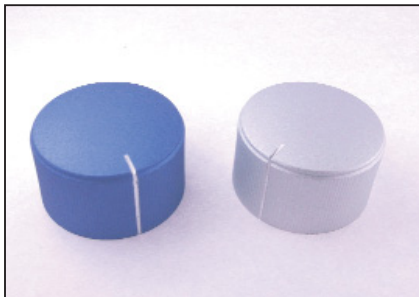

KMK25

6mm Splined shaft

FC7252 - Silver Anodised

FC7253 - Black Anodised

6mm USA 'D' shaft

FC7254 - Silver Anodised

FC7255 - Black Anodised

Other anodised colours available.

KMK10E

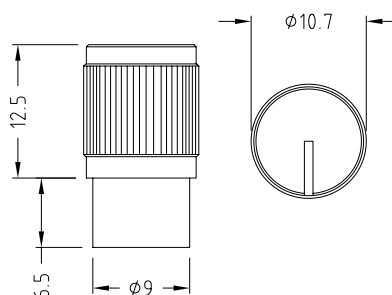
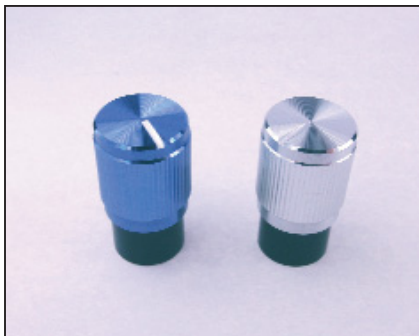

KMK10E

6mm Splined shaft

FC7256 - Silver Anodised

FC7257 - Black Anodised

6mm USA 'D' shaft

FC7258 - Silver Anodised

FC7259 - Black Anodised

Other anodised colours available.

SHAFT DETAILS

When specifying fixing options below, indicate shaft size and type, i.e: screw fix (SF), push fix (D), splined (SPL) or collet.

SHAFT SIZE	3mm	4mm	4mm	4mm	4mm	6mm	6mm	6mm U.S.A.	6mm	6mm	1/4 inch	1/4 inch	1/4 inch	1/4 inch	1/4 inch	MARKER DOT & LINE OPTIONS
Knob Type	Collet	Splined	D-Spring	Screw	6mm	6mm	6mm	6mm	6mm	6mm	1/4 inch	1/4 inch	1/4 inch	1/4 inch	1/4 inch	Options
K1C																S (std)
K3C, K4C																Z
K5, K8																Z, S
K6C, K6C/SKT																D SLN
K7C																Z
K85, K88																Z (std)
K85M																Z (std)
K86R, K86AR																LZ
K87MA, K87MB +																LZ
K9 *																LDZ
K10 *																LDZ
K11																LDZ
K12																LDZ
K14																Z
K15, K15P																K15 - Z
K16, K16P																K16 - Z
K17																Z (std)
K18																
K19																D
C18, C18/SKT																C18 - Z (std) C18/SKT SLN
KM12B, KM15B																
KM20B, KM40B, KM50B																
KMK SERIES																
KMR SERIES																
KEY	Collet	Splined	D-Spring	Screw												● = AVAILABLE - STD ∅ = ENQUIRE IF REQD.

* For All Black model only - version with integral cap is available. NOT ALL PUSH FIX MODELS HAVE METAL SPRINGS.
+ Including 'R' 'Soft Touch' versions.