

Contents

- **Scope** P.1
- **Performance** P.1
- **Marking** P.4
- **Catalog Numbering** P.4
- **Parts Lists** P.5~7

Electrolytic Capacitor Product Specification

VC TYPE CB SERIES

1

I.Scope

This standard defines characteristics and dimensions for aluminum electrolytic capacitors named CB series for general purpose.

II.Performance

1.Operating Temperature Range

-40°C ~ +105°C

Shipping Temperature

-40°C ~ +70°C

2.Capacitance Tolerance

Capacitance tolerance should be within the range of $\pm 20\%$ which is measured at 120 Hz/20°C.

3.Dissipation Factor ($\tan \delta$)

Shown in the attached table at 120 Hz/20°C.

4.Rated DC Working Voltage (WV) and DC Surge Voltage (CB)

Rated Voltage(V)	4	6.3	10	16	25	35	50
Surge Voltage(V)	5	8	13	20	32	44	63

5.Leakage Current

The maximum leakage current is specified in the following formula after DC working voltage applied for 2 minutes.

$I \leq 0.01CV$ or $3 (\mu A)$ whichever is greater

where I: Leakage Current (μA) at 20°C

C: Nominal Capacitance (μF)

V: Working Voltage (VDC)

6.Low Temperature Characteristics

The ratio of impedance at -25°C/20°C and -40°C/20°C of the capacitor shall be less than the following value at 120 Hz.

YAGEO ELECTRONIC CORPORATION
Engineering Dept..

Electrolytic Capacitor Product Specification

VC TYPE CB SERIES

2

WV comparison Z	4	6.3	10	16	25	35	50
Z(-25°C)/(Z20°C)	7	4	3	2	2	2	2
Z(-40°C)/(Z20°C)	15	8	6	4	4	3	3

7. Multiplier for Ripple Current

Freq.(Hz)	60	120	1K	10K
Coefficient	0.80	1.00	1.15	1.25

8. Load Life Test

The following specifications shall be satisfied when the capacitors are restored to 20°C after rated working voltage applied at 105±2°C for 1000 +12 / -0 hours.

Capacitance Change	Within ±20% of the initial value
Dissipation Factor	Not more than 200% of the specified value
Leakage Current	Not more than the specified value

9. Shelf Life Test

The following specifications shall be satisfied when the capacitors are restored to 20°C after exposing them at 105±2°C without voltage applied for 1000 +12 / -0 hours.

Capacitance Change	Within ±20% of the initial value
Dissipation Factor	Not more than 200% of the specified value
Leakage Current	Not more than the specified value

10. Solderability Test

The following specifications shall be satisfied when the lead wires are tested in solder bath at 235±5°C for 2±0.5 seconds, more than 95% of the terminal surface shall be covered with new solder.

11. Solder Heat Resistance Test

The following specifications shall be satisfied when the lead wires are tested in solder bath at 260±5°C for 10±1 seconds.

Capacitance Change	≤ ±5% of the initial value
Dissipation factor	≤ Initial specified value
Leakage Current	≤ Initial specified value

12. Reflow Soldering Heat Resistance Test

After reflow soldering, the following specifications shall be satisfied when the capacitors are restored to 20°C.

Capacitance Change	Within ±10% of the initial value
Dissipation Factor	Not more than the specified value
Leakage Current	Not more than the specified value

13. Lead Free Reflow Soldering Condition

(1) For reflow, use a thermal conduction system such as infrared radiation (IR) or hot blast.

Vapor heat transfer systems are not recommended.

(2) Observe proper soldering conditions (temperature, time, etc.). Do not exceed the specified limits.

(3) Reflow could be performed twice. Please make sure the parts have enough cooling down time between the first and second soldering process.

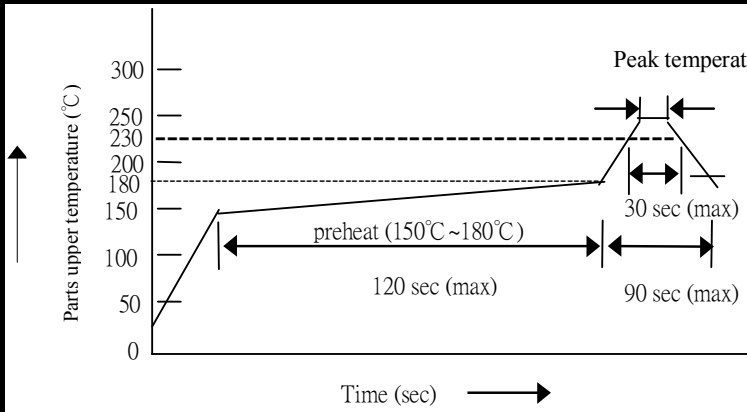

Chip capacitor reflow guaranteed condition

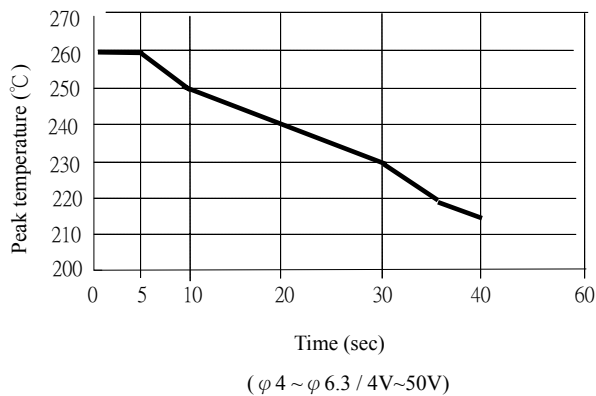

Chip capacitor reflow guaranteed condition

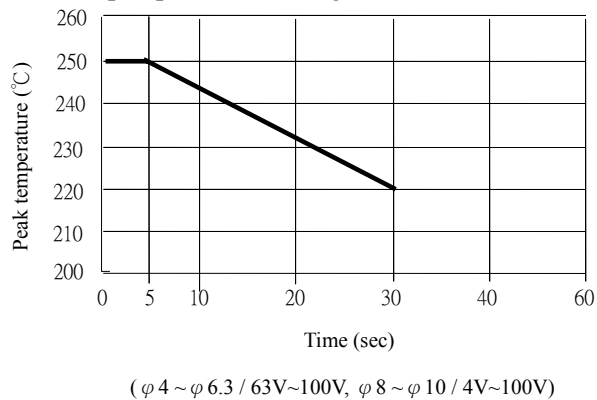

14.Storage Condition

- (1) Aluminium Electrolytic Capacitors should not be stored in high temperatures or where there is a high level of humidity. The suitable storage condition is 5~35°C and less than 75% in relative humidity.
- (2) Aluminium Electrolytic Capacitors should not be stored in damp conditions such as water, saltwater spray or oil spray.
- (3) Do not store Aluminium Electrolytic Capacitors in an environment full of hazardous gas (hydrogen sulfide , sulfurous acid gas, nitrous acid, chlorine gas, ammonium, etc...).
- (4) Aluminium Electrolytic Capacitors should not be stored under exposure to ozone, ultraviolet rays or radiation.
- (5) If a capacitor has been stored for more than one year under normal temperature (shorter if high temperature) and it shows increased leakage current, then a treatment by voltage application is recommended.

15.Environment-Related Substances

All Luxon capacitors comply to RoHS (Restriction of Hazardous Substances) requirements where Chromium VI (Cr⁺⁶), Cadmium (Cd), Mercury (Hg), Lead (Pb), Polybrominated biphenyls (PBBs) and Polybrominated biphenyl / diphenyl ethers (PBDEs / PBDEs) have not detected (lower than MDL (Method Detection Limit)) per SGS certification test report.

16.Others

- (1)All Luxon cp wires of electrolytic capacitors are without lead (Pb).
- (2)Satisfied characteristic JIS C 5101.
- (3)Aluminum Electrolytic Capacitors may be damaged by corrosion which is caused by any halogenated hydrocarbon solvents.
Please let us know in advance the solvent name and conditions for your PCB cleaning.

III.Marking

1.Following items shall be marked on the body of Capacitor.

(Note: color of the marking is black)

a)Rated Working Voltage

6.3V of rated working voltage shall be marked as 6V, but 6.3V shall be assured and 5.5V of rated working voltage shall be marked as 5V, but 5.5V shall be assured.

b)Nominal Capacitance

c)Negative polarity

d)Series mark

e)Lot No.

2.On the Taping Reel

a)Rated working voltage, rated capacitance

b)G-luxon electric trademark

c)Part number

d)Packing quantity

e)Serial No.

f)Manufacturer's Name(YAGEO Electronics corporation)

Catalog numbering

YAGEO CB TYPE (Part Number)

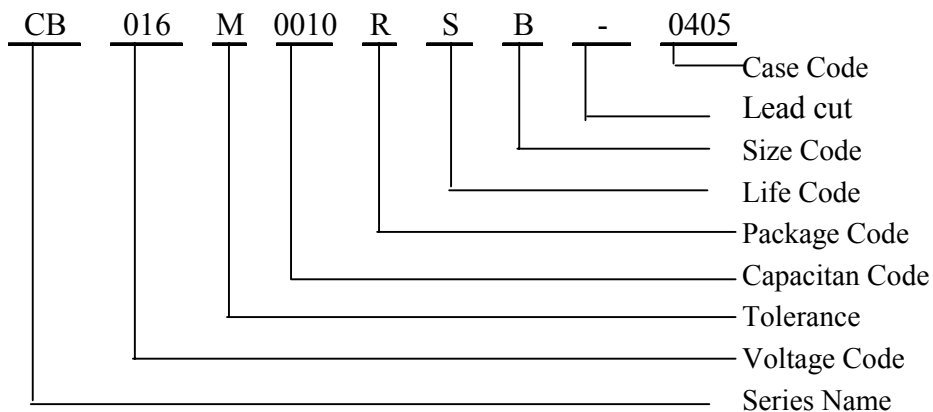

3. Dimensions and appearance (unit: mm)

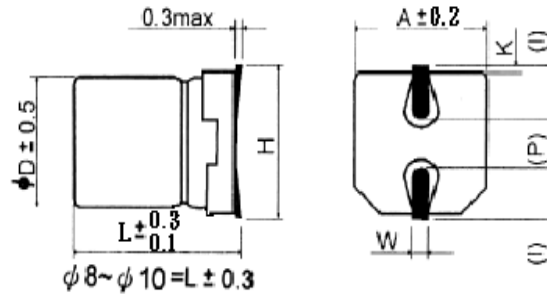
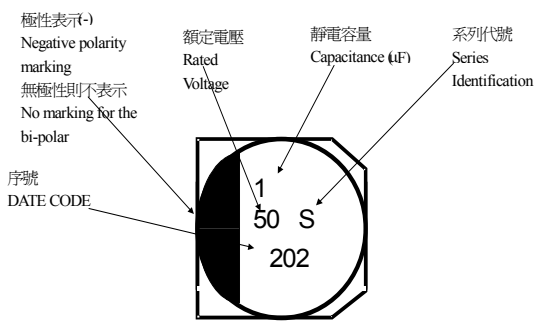

(): Reference size

φ D	L	A	H	I	W	P	K
4.0	5.4+0.3 -0.1	4.3±0.2	5.5MAX	1.8±0.1	0.65±0.1	1.0±0.2	0.35+0.15 -0.20
5.0	5.4+0.3 -0.1	5.3±0.2	6.5MAX	2.2±0.1	0.65±0.1	1.5±0.2	0.35+0.15 -0.20
6.3	5.4+0.3 -0.1	6.6±0.2	7.8MAX	2.6±0.1	0.65±0.1	1.8±0.2	0.35+0.15 -0.20
8.0	6.2±0.3	8.3±0.2	9.5MAX	3.4±0.1	0.65±0.1	2.2±0.2	0.35+0.15 -0.20
8.0	10.2±0.3	8.3±0.2	10.0MAX	3.4±0.1	0.90±0.2	3.1±0.2	0.70±0.2
10.0	10.2±0.3	10.3±0.2	12.0MAX	3.5±0.1	0.90±0.2	4.6±0.2	0.70±0.2

4. Land/Pad Pattern

The circuit board land/pad pattern size for chip capacitors is specified in the following table .

[Table of Board Land Size vs. Capacitor Size]

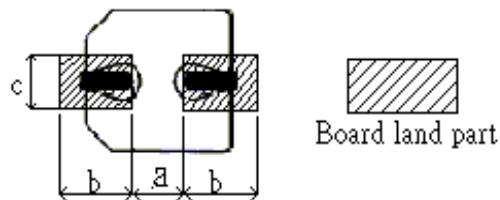

(mm)

Size	a	b	c
φ 4.0x5.4 L	1.0	2.5	1.6
φ 5.0x5.4 L	1.5	2.8	1.6
φ 6.3x5.4 L	1.8	3.2	1.6
φ 8.0x6.2 L	2.2	4.0	1.6
φ 8.0x10.2 L	3.1	4.0	2.0
φ 10.0x10.2 L	4.6	4.1	2.0

Among others, when the size a is wide, back fillet can not be made, decreasing fitting strength.

* Decide considering mounting condition, solderability and fitting strength, etc. based on the design standards of your company.

Electrolytic Capacitor Product Specification

VC TYPE CB SERIES

6

Parts lists

Size Code	Part N0	R.V V.DC	Cap (μ F)	Tangent of Loss Angle ($\tan \delta$) MAX	Rated Ripple Current mA r.m.s (120Hz 105°C) MAX	ESR (Ω)(max) 120Hz,20°C
B	CB004M0022RSB-0405	4	22	0.35	20	21.1
B	CB004M0033RSB-0405	4	33	0.35	26	14.0
B	CB004M0047RSB-0405	4	47	0.35	34	9.87
C	CB004M0100RSC-0505	4	100	0.35	61	4.64
D	CB004M0220RSD-0605	4	220	0.35	82	2.11
B	CB006M0022RSB-0405	6.3	22	0.30	29	18.0
B	CB006M0033RSB-0405	6.3	33	0.30	43	12.0
C	CB006M0047RSC-0505	6.3	47	0.30	46	8.46
D	CB006M0100RSD-0605	6.3	100	0.35	71	4.64
H	CB006M0220RSH-0607	6.3	220	0.35	120	2.11
E	CB006M0220RSE-0806	6.3	220	0.35	130	2.11
F	CB006M0330REF-0607	6.3	330	0.35	175	1.40
H	CB006M0330RSH-0810	6.3	330	0.35	230	1.40
G	CB006M0470RSG-1010	6.3	470	0.35	260	0.99
G	CB006M1000RSG-1010	6.3	1000	0.35	380	0.46
B	CB010M0010RSB-0405	10	10	0.30	24	39.7
B	CB010M0022RSB-0405	10	22	0.30	36	18.0
B	CB010M0033RSB-0405	10	33	0.30	45	12.0
D	CB010M0047RSD-0605	10	47	0.30	70	8.46
E	CB010M0100RSE-0806	10	100	0.30	110	3.97
H	CB010M0220RSH-0607	10	220	0.30	115	1.80
F	CB010M0220RSF-0810	10	220	0.26	160	1.80
G	CB010M0330RSG-1010	10	330	0.26	230	1.04
G	CB010M0470RSG-1010	10	470	0.26	270	0.73
G	CB010M1000RSG-1010	10	1000	0.26	390	0.34
B	CB016M4R70RSB-0405	16	4.7	0.16	20	45.1
B	CB016M0010RSB-0405	16	10	0.16	28	21.2
C	CB016M0022RSC-0505	16	22	0.16	39	9.64
D	CB016M0033RSD-0605	16	33	0.20	65	8.03
D	CB016M0047RSD-0605	16	47	0.20	70	5.64
H	CB016M0047RSH-0607	16	47	0.20	125	2.39
E	CB016M0100RSE-0806	16	100	0.20	130	2.65
H	CB016M0220RSH-0607	16	220	0.20	100	1.08
G	CB016M0220RSG-1010	16	220	0.20	210	1.20
G	CB016M0330RSG-1010	16	330	0.20	230	0.80
G	CB016M0470RSG-1010	16	470	0.20	275	0.56

YAGEO ELECTRONIC CORPORATION
Engineering Dept..

Electrolytic Capacitor Product Specification

VC TYPE CB SERIES

7

Parts lists

Size Code	Part N0	R.V V.DC	Cap (μ F)	Tangent of Loss Angle ($\tan \delta$) MAX	Rated Ripple Current mA r.m.s (120Hz 105°C) MAX	ESR (Ω)(max) 120Hz,20°C
B	CB025M4R70RSB-0405	25	4.7	0.14	22	39.5
C	CB025M0010RSC-0505	25	10	0.14	28	18.5
D	CB025M0022RSD-0605	25	22	0.14	55	8.44
D	CB025M0033RSD-0605	25	33	0.16	65	6.43
E	CB025M0047RSE-0806	25	47	0.16	91	4.51
H	CB025M0100RSH-0607	25	100	0.16	95	2.12
F	CB025M0100RSF-0810	25	100	0.16	130	2.12
G	CB025M0220RSG-1010	25	220	0.16	273	0.96
B	CB035M2R20RSB-0405	35	2.2	0.12	15	72.3
B	CB035M3R30RSB-0405	35	3.3	0.12	18	48.2
B	CB035M4R70RSB-0405	35	4.7	0.12	22	33.8
C	CB035M0010RSC-0505	35	10	0.12	30	15.9
D	CB035M0022RSD-0605	35	22	0.14	60	8.44
E	CB035M0033RSE-0806	35	33	0.14	84	5.62
F	CB035M0047RSF-0810	35	47	0.14	98	3.95
H	CB035M0100RSH-0607	35	100	0.14	105	1.85
G	CB035M0100RSG-1010	35	100	0.14	160	1.85
G	CB035M0220RSG-1010	35	220	0.14	240	0.84
B	CB050M0R10RSB-0405	50	0.1	0.12	1	1593
B	CB050M0R22RSB-0405	50	0.22	0.12	2	723
B	CB050M0R33RSB-0405	50	0.33	0.12	3	482
B	CB050M0R47RSB-0405	50	0.47	0.12	5	338
B	CB050M1R00RSB-0405	50	1.0	0.12	10	159
B	CB050M2R20RSB-0405	50	2.2	0.12	16	72.3
B	CB050M3R30RSB-0405	50	3.3	0.12	1	48.2
B	CB050M4R70RSB-0405	50	4.7	0.12	3	33.8
C	CB050M4R70RSC-0505	50	4.7	0.12	23	33.8
D	CB050M0010RSD-0605	50	10	0.12	35	15.9
H	CB050M0022RSH-0607	50	22	0.12	65	7.23
E	CB050M0022RSE-0806	50	22	0.12	70	7.23
H	CB050M0033RSH-0607	50	33	0.12	70	4.82
F	CB050M0033RSF-0810	50	33	0.12	91	4.82
H	CB050M0047RSH-0607	50	47	0.12	65	3.38
G	CB050M0047RSG-1010	50	47	0.12	100	3.38
G	CB050M0100RSG-1010	50	100	0.12	145	1.59

YAGEO ELECTRONIC CORPORATION
Engineering Dept..

Yageo Corporation

3F, 233-1, Pao Chiao Rd.,
Hsin Tien, Taipei, Taiwn

Tel: 886.2.2917.7555

Fax: 886.2.2917.3789