

YAGEO

**Product Selection Tables
2005**

MLCC

Yageo brand



YAGEO



Table of Contents

| Table of contents | |
|--|----|
| MLCC - NP0 / Yageo brand | 2 |
| NP0, 16V, general purpose | 2 |
| NP0, 25V, general purpose | 3 |
| NP0, 50V, general purpose | 4 |
| NP0, 100V, general purpose | 6 |
| NP0, 200V and 500V, medium voltage | 7 |
| MLCC - X7R / Yageo brand | 8 |
| X7R, 10V, general purpose | 8 |
| X7R, 16V and 25V, general purpose | 9 |
| X7R, 50V and 100V, general purpose | 10 |
| X7R, 200V, 250V and 500V, medium voltage | 11 |
| MLCC - Y5V / Yageo brand | 12 |
| Y5V, 10V to 50V, general purpose | 12 |
| General information | 13 |
| Ordering and packing | 13 |
| Yageo - A Global Company | 15 |
| Contact information | 15 |

MLCC - NP0 / Yageo brand

NP0, 16V, general purpose

| NP0 - 16V | | | |
|-----------------|------------------------------------|-----------|-----------|
| General purpose | | | |
| Capacitance | Last 3 digits of Yageo part number | 16V | |
| | | 0402 | 0603 |
| 270 pF | 271 | 0.5 ±0.05 | |
| 330 pF | 331 | | |
| 390 pF | 391 | | |
| 470 pF | 471 | | |
| 1.8 nF | 182 | | 0.8 ±0.07 |
| 2.2 nF | 222 | | |
| 2.7 nF | 272 | | |
| 3.3 nF | 332 | | |
| Tape width | | 8mm | |

Note: Values in shaded cells indicate thickness class (Unit: mm)

MLCC - NP0 / Yageo brand

NP0, 25V, general purpose

| NP0 - 25V | | | | | |
|-----------------|------------------------------------|-----------|-----------|-----------|------------|
| General purpose | | | | | |
| Capacitance | Last 3 digits of Yageo part number | 25V | | | |
| | | 0603 | 0805 | 1206 | 1210 |
| 820 pF | 821 | 0.8 ±0.07 | | | |
| 1000 pF | 102 | | | | |
| 1.2 nF | 122 | | | | |
| 1.5 nF | 152 | | | | |
| 3.3 nF | 332 | | 0.85 ±0.1 | | |
| 3.9 nF | 392 | | 1.25 ±0.1 | | |
| 4.7 nF | 472 | | | | |
| 8.2 nF | 822 | | | 0.85 ±0.1 | |
| 10 nF | 103 | | | | |
| 12 nF | 123 | | | | 0.6 ±0.1 |
| 15 nF | 153 | | | | 0.85 ±0.1 |
| 18 nF | 183 | | | | |
| 22 nF | 223 | | | | 1.15 ±0.15 |
| Tape width | | 8mm | | | |

Note: Values in shaded cells indicate thickness class (Unit: mm)

MLCC - NP0 / Yageo brand

NP0, 50V, general purpose

| NP0 - 50V | | | | | | | |
|-----------------|------------------------------------|-----------|-----------|-----------|-----------|-----------|----------|
| General purpose | | | | | | | |
| Capacitance | Last 3 digits of Yageo part number | 50V | | | | | |
| | | 0402 | 0603 | 0805 | 1206 | 1210 | 1812 |
| 0.47 pF | R47 | 0.5 ±0.05 | 0.8 ±0.07 | 0.6 ±0.1 | 0.6 ±0.1 | | |
| 0.56 pF | R56 | | | | | | |
| 0.68 pF | R68 | | | | | | |
| 0.82 pF | R82 | | | | | | |
| 1 pF | 1R0 | | | | | | |
| 1.2 pF | 1R2 | | | | | | |
| 1.5 pF | 1R5 | | | | | | |
| 1.8 pF | 1R8 | | | | | | |
| 2.2 pF | 2R2 | | | | | | |
| 2.7 pF | 2R7 | | | | | | |
| 3.3 pF | 3R3 | | | | | | |
| 3.9 pF | 3R9 | | | | | | |
| 4.7 pF | 4R7 | | | | | | |
| 5.6 pF | 5R6 | | | | | | |
| 6.8 pF | 6R8 | | | | | | |
| 8.2 pF | 8R2 | | | | | | |
| 10 pF | 100 | | | | | | |
| 12 pF | 120 | | | | | | |
| 15 pF | 150 | | | | | | |
| 18 pF | 180 | | | | | | |
| 22 pF | 220 | | | | | | |
| 27 pF | 270 | | | | | | |
| 33 pF | 330 | | | | | | |
| 39 pF | 390 | | | | | | |
| 47 pF | 470 | | | | | 0.6 ±0.1 | |
| 56 pF | 560 | | | | | | |
| 68 pF | 680 | | | | | | |
| 82 pF | 820 | | | | | | |
| 100 pF | 101 | | | | | | |
| 120 pF | 121 | | | | | | |
| 150 pF | 151 | | | | | | |
| 180 pF | 181 | | | | | | |
| 220 pF | 221 | | | | | | |
| 270 pF | 271 | | | | | | |
| 330 pF | 331 | | | | | | 0.6 ±0.1 |
| 390 pF | 391 | | | | | | |
| 470 pF | 471 | | | | | | |
| 560 pF | 561 | | | | | | |
| 680 pF | 681 | | | | | | |
| 820 pF | 821 | | | | | | |
| 1000 pF | 102 | | | | | | |
| 1.2 nF | 122 | | | 0.85 ±0.1 | | | |
| 1.5 nF | 152 | | | | | | |
| 1.8 nF | 182 | | | | | | |
| 2.2 nF | 222 | | | 1.25 ±0.1 | | | |
| 2.7 nF | 272 | | | | | | |
| 3.3 nF | 332 | | | | 0.85 ±0.1 | | |
| 3.9 nF | 392 | | | | | | |
| 4.7 nF | 472 | | | | | | |
| 5.6 nF | 562 | | | | 1.15 ±0.1 | 0.85 ±0.1 | |
| 6.8 nF | 682 | | | | | | |

MLCC - NP0 / Yageo brand

NP0, 50V, general purpose

| NP0 - 50V | | | | | | | | |
|-----------------|------------------------------------|------|------|------|------|------|------------|--|
| General purpose | | | | | | | | |
| Capacitance | Last 3 digits of Yageo part number | 50V | | | | | | |
| | | 0402 | 0603 | 0805 | 1206 | 1210 | 1812 | |
| 8.2 nF | 822 | | | | | | | |
| 10 nF | 103 | | | | | | | |
| 12 nF | 123 | | | | | | 0.85 ±0.1 | |
| 15 nF | 153 | | | | | | | |
| 18 nF | 183 | | | | | | 1.15 ±0.15 | |
| 22 nF | 223 | | | | | | | |
| Tape width | | 8mm | | | | | 12mm | |

Note: Values in shaded cells indicate thickness class (Unit: mm)

MLCC - NP0 / Yageo brand

NP0, 100V, general purpose

| NP0 - 100V | | | | | | |
|-----------------|------------------------------------|-----------|-----------|-----------|-----------|------------|
| General purpose | | | | | | |
| Capacitance | Last 3 digits of Yageo part number | 100V | | | | |
| | | 0603 | 0805 | 1206 | 1210 | 1812 |
| 10 pF | 100 | 0.8 ±0.07 | 0.6 ±0.1 | 0.6 ±0.1 | | |
| 12 pF | 120 | | | | | |
| 15 pF | 150 | | | | | |
| 18 pF | 180 | | | | | |
| 22 pF | 220 | | | | | |
| 27 pF | 270 | | | | | |
| 33 pF | 330 | | | | | |
| 39 pF | 390 | | | | | |
| 47 pF | 470 | | | | | |
| 56 pF | 560 | | | | | |
| 68 pF | 680 | | | | | |
| 82 pF | 820 | | | | | |
| 100 pF | 101 | | | | | |
| 120 pF | 121 | | | | | |
| 150 pF | 151 | | | | | |
| 180 pF | 181 | | | | | |
| 220 pF | 221 | | | | | |
| 270 pF | 271 | | | | | |
| 330 pF | 331 | | | | | |
| 390 pF | 391 | | | | | |
| 470 pF | 471 | | | | | |
| 560 pF | 561 | | | | | |
| 680 pF | 681 | | | | | |
| 820 pF | 821 | | | | | |
| 1000 pF | 102 | | | | | |
| 1.2 nF | 122 | | 0.85 ±0.1 | | | |
| 1.5 nF | 152 | | | | | |
| 1.8 nF | 182 | | | | | |
| 2.2 nF | 222 | | 1.25 ±0.1 | | | |
| 2.7 nF | 272 | | | | | |
| 3.3 nF | 332 | | | 0.85 ±0.1 | | |
| 3.9 nF | 392 | | | | | |
| 4.7 nF | 472 | | | | | |
| 5.6 nF | 562 | | | 1.15 ±0.1 | | |
| 6.8 nF | 682 | | | | | |
| 8.2 nF | 822 | | | | 0.85 ±0.1 | |
| 10 nF | 103 | | | | | |
| 12 nF | 123 | | | | | 0.85 ±0.1 |
| 15 nF | 153 | | | | | |
| 18 nF | 183 | | | | | 1.15 ±0.15 |
| 22 nF | 223 | | | | | |
| Tape width | | 8mm | | | | 12mm |

Note: Values in shaded cells indicate thickness class (Unit: mm)

MLCC - NP0 / Yageo brand

NP0, 200V and 500V, medium voltage

| NP0 - 200V and 500V | | | | | | | | | |
|---------------------|------------------------------------|-----------|-----------|------------|------------|-----------|------------|------------|------|
| Medium voltage | | | | | | | | | |
| Capacitance | Last 3 digits of Yageo part number | 200V | | | | 500V | | | |
| | | 0805 | 1206 | 1210 | 1812 | 1206 | 1210 | 1812 | |
| 10 pF | 100 | 0.6 ±0.1 | 0.6 ±0.1 | | | 0.6 ±0.1 | | | |
| 12 pF | 120 | | | | | | | | |
| 15 pF | 150 | | | | | | | | |
| 18 pF | 180 | | | | | | | | |
| 22 pF | 220 | | | | | | | | |
| 27 pF | 270 | | | | | | | | |
| 33 pF | 330 | | | | | | | | |
| 39 pF | 390 | | | | | | | | |
| 47 pF | 470 | | | | | | 0.85 ±0.1 | | |
| 56 pF | 560 | | | | | | | | |
| 68 pF | 680 | | | | | | | | |
| 82 pF | 820 | | | | | | | | |
| 100 pF | 101 | | | | | | | | |
| 120 pF | 121 | | | | | | | | |
| 150 pF | 151 | | | | | | | | |
| 180 pF | 181 | | | | | | | | |
| 220 pF | 221 | 0.85 ±0.1 | 0.85 ±0.1 | | | 0.85 ±0.1 | | | |
| 270 pF | 271 | | | | | | | | |
| 330 pF | 331 | | | | | | | | |
| 390 pF | 391 | | | | | | | | |
| 470 pF | 471 | | | | | | | | |
| 560 pF | 561 | 1.25 ±0.1 | | | | 1.15 ±0.1 | | | |
| 680 pF | 681 | | | | | | | | |
| 820 pF | 821 | | | | | | | | |
| 1000 pF | 102 | | | | | | 1.15 ±0.15 | | |
| 1.2 nF | 122 | | | | | | | | |
| 1.5 nF | 152 | | 1.15 ±0.1 | | | | | | |
| 1.8 nF | 182 | | | 0.85 ±0.1 | | | | | |
| 2.2 nF | 222 | | | | | | | 1.15 ±0.15 | |
| 2.7 nF | 272 | | | 1.15 ±0.15 | | | | | |
| 3.3 nF | 332 | | | | | | | | |
| 3.9 nF | 392 | | | | 0.85 ±0.1 | | | | |
| 4.7 nF | 472 | | | | 1.15 ±0.15 | | | | |
| 5.6 nF | 562 | | | | | | | | |
| Tape width | | 8mm | | | 12mm | | 8mm | | 12mm |

Note: Values in shaded cells indicate thickness class (Unit: mm)

MLCC - X7R / Yageo brand

X7R, 10V, general purpose

| X7R - 10V | | | | |
|-----------------|------------------------------------|-----------|-----------|-----------|
| General purpose | | | | |
| Capacitance | Last 3 digits of Yageo part number | 10V | | |
| | | 0603 | 0805 | 1206 |
| 150 nF | 154 | 0.8 ±0.07 | | |
| 220 nF | 224 | | 0.6 ±0.1 | |
| 330 nF | 334 | | 0.85 ±0.1 | |
| 470 nF | 474 | | | |
| 680 nF | 684 | | 1.25 ±0.1 | |
| 1000 nF | 105 | | | 0.85 ±0.1 |
| 1.5 µF | 155 | | | 1.15 ±0.1 |
| 2.2 µF | 225 | | | |
| 4.7 µF | 475 | | | 1.6 ±0.2 |
| Tape width | | 8 mm | | |

Note: Values in shaded cells indicate thickness class (Unit: mm)

MLCC - X7R / Yageo brand

X7R, 16V and 25V, general purpose

| X7R - 16V and 25V | | | | | | | | | | |
|-------------------|------------------------------------|-----------|-----------|-----------|-----------|-----------|-----------|-----------|-----------|-----------|
| General purpose | | | | | | | | | | |
| Capacitance | Last 3 digits of Yageo part number | 16V | | | | 25V | | | | |
| | | 0402 | 0603 | 0805 | 1206 | 0402 | 0603 | 0805 | 1206 | 1210 |
| 3.3 nF | 332 | | | | | 0.5 ±0.05 | | | | |
| 4.7 nF | 472 | | | | | | | | | |
| 6.8 nF | 682 | 0.5 ±0.05 | | | | | | | | |
| 10 nF | 103 | | | | | | 0.8 ±0.07 | 0.6 ±0.1 | | |
| 15 nF | 153 | | | | | | | | | |
| 22 nF | 223 | | | | | | | | | |
| 33 nF | 333 | | 0.8 ±0.07 | | | | | | | |
| 47 nF | 473 | 0.5 ±0.05 | | 0.6 ±0.1 | | | | 0.85 ±0.1 | | |
| 68 nF | 683 | | | | | | | | | |
| 100 nF | 104 | | | 0.85 ±0.1 | | | | | 0.85 ±0.1 | |
| 150 nF | 154 | | | | | | | | | |
| 220 nF | 224 | | | | 0.85 ±0.1 | | | | | 0.85 ±0.1 |
| 330 nF | 334 | | | 1.25 ±0.1 | | | | | 1.15 ±0.1 | |
| 470 nF | 474 | | | | 1.15 ±0.1 | | | | | |
| 680 nF | 684 | | | | | | | | | |
| 1000 nF | 105 | | | | | | | | 1.6 ±0.2 | |
| Tape width | | 8mm | | | | | | | | |

Note: Values in shaded cells indicate thickness class (Unit: mm)

MLCC - X7R / Yageo brand

X7R, 50V and 100V, general purpose

| X7R - 50V and 100V | | | | | | | | | | | | |
|--------------------|------------------------------------|-----------|-----------|-----------|-----------|-----------|-----------|-----------|-----------|-----------|-----------|------|
| General purpose | | | | | | | | | | | | |
| Capacitance | Last 3 digits of Yageo part number | 50V | | | | | | 100V | | | | |
| | | 0402 | 0603 | 0805 | 1206 | 1210 | 1812 | 0805 | 1206 | 1210 | 1812 | |
| 100 pF | 101 | 0.5 ±0.05 | 0.8 ±0.07 | | | | | | | | | |
| 150 pF | 151 | | | | | | | | | | | |
| 220 pF | 221 | | | 0.6 ±0.1 | 0.85 ±0.1 | | | 0.6 ±0.1 | 0.85 ±0.1 | | | |
| 330 pF | 331 | | | | | | | | | | | |
| 470 pF | 471 | | | | | | | | | | | |
| 680 pF | 681 | | | | | | | | | | | |
| 1000 pF | 102 | | | | | | | | | | | |
| 1.5 nF | 152 | | | | | | | | | | | |
| 2.2 nF | 222 | | | | | | | | | | | |
| 3.3 nF | 332 | | | | | | | | | | | |
| 4.7 nF | 472 | | | | | | | | | | | |
| 6.8 nF | 682 | | | | | | | | | | | |
| 10 nF | 103 | | | | | 0.85 ±0.1 | | | | | | |
| 15 nF | 153 | | | | | | | 0.85 ±0.1 | | | | |
| 22 nF | 223 | | | | | | | | | | | |
| 33 nF | 333 | | | 0.85 ±0.1 | | | | | | | | |
| 47 nF | 473 | | | | | | | | | 0.85 ±0.1 | | |
| 68 nF | 683 | | | | | | | | 1.15 ±0.1 | | | |
| 100 nF | 104 | | | | | | 1.15 ±0.1 | | | | 1.15 ±0.1 | |
| 150 nF | 154 | | | | 1.15 ±0.1 | 1.15 ±0.1 | | | | 1.15 ±0.1 | | |
| 220 nF | 224 | | | | | | | | | | | |
| 330 nF | 334 | | | | | | | | | | | |
| 470 nF | 474 | | | | | | | | | | 1.6 ±0.2 | |
| 680 nF | 684 | | | | | | | 1.6 ±0.2 | | | | |
| 1000 nF | 105 | | | | | | | | | | | |
| Tape width | | 8mm | | | | | 12mm | | 8mm | | | 12mm |

Note: Values in shaded cells indicate thickness class (Unit: mm)

MLCC - X7R / Yageo brand

X7R, 200V, 250V and 500V, medium voltage

| X7R - 200 V and 500 V | | | | | | | | |
|-----------------------|------------------------------------|-----------|-----------|-----------|-----------|-----------|-----------|-----------|
| Medium voltage | | | | | | | | |
| Capacitance | Last 3 digits of Yageo part number | 200V | | | | 500V | | |
| | | 0805 | 1206 | 1210 | 1812 | 1206 | 1210 | 1812 |
| 220 pF | 221 | 0.85 ±0.1 | | | | | | |
| 330 pF | 331 | | | | | | | |
| 470 pF | 471 | | | | | 1.15 ±0.1 | | |
| 680 pF | 681 | | 0.85 ±0.1 | | | | | |
| 1000 pF | 102 | | | | | | | |
| 1.5 nF | 152 | | | | | | | |
| 2.2 nF | 222 | | | | | | | |
| 3.3 nF | 332 | | | | | | 1.15 ±0.1 | |
| 4.7 nF | 472 | | | | | | | |
| 6.8 nF | 682 | 1.25 ±0.1 | | | | | | |
| 10 nF | 103 | | | | | | | 1.15 ±0.1 |
| 15 nF | 153 | | | | | | | |
| 22 nF | 223 | | 1.15 ±0.1 | 1.15 ±0.1 | | | | |
| 33 nF | 333 | | | | | | | |
| 47 nF | 473 | | | | 1.15 ±0.1 | | | |
| 68 nF | 683 | | | | | | | |
| 100 nF | 104 | | | | | | | |
| Tape width | | 8mm | | | 12mm | 8mm | | 12mm |

Note: Values in shaded cells indicate thickness class (Unit: mm)

MLCC - Y5V / Yageo brand

Y5V, 10V to 50V, general purpose

| Y5V - 16V to 50V | | | | | | | | | | | |
|------------------|------------------------------------|-----------|-----------|-----------|-----------|-----------|-----------|-----------|-----------|-----------|-----------|
| General purpose | | | | | | | | | | | |
| Capacitance | Last 3 digits of Yageo part number | 16V | | | | 25V | | | 50V | | |
| | | 0402 | 0603 | 0805 | 1206 | 0603 | 0805 | 1206 | 0603 | 0805 | 1206 |
| 10 nF | 103 | 0.5 ±0.05 | | | | 0.8 ±0.07 | | | 0.8 ±0.07 | 0.6 ±0.1 | |
| 22 nF | 223 | | | | | | | | | | |
| 47 nF | 473 | | | | | | | | | | |
| 100 nF | 104 | | | | | | 0.6 ±0.1 | 0.6 ±0.1 | | | 0.6 ±0.1 |
| 220 nF | 224 | | 0.8 ±0.07 | | | | 0.85 ±0.1 | | | 0.85 ±0.1 | |
| 470 nF | 474 | | | 0.85 ±0.1 | | | 1.25 ±0.1 | 0.85 ±0.1 | | | 0.85 ±0.1 |
| 1000 nF | 105 | | | 1.25 ±0.1 | 0.85 ±0.1 | | | 1.15 ±0.1 | | | 1.15 ±0.1 |
| Tape width | | 8mm | | | | | | | | | |

Note: Values in shaded cells indicate thickness class (Unit: mm)

General information

Ordering and packing

Ordering Information:



Thickness classes and packing quantities

| Size Code | Thickness Classification (mm) | Tape Width Quantity Per Reel | 180 mm / 7" | | 330 mm / 13" | | Quantity Per Bulk Case |
|-----------|-------------------------------|------------------------------|-------------|---------|--------------|---------|------------------------|
| | | | Paper | Blister | Paper | Blister | |
| CC0402 | 0.5±0.05 | 8 mm | 10 000 | --- | 50 000 | --- | 50 000 |
| CC0603 | 0.8±0.07 | 8 mm | 4 000 | --- | 15 000 | --- | 15 000 |
| CC0805 | 0.6±0.1 | 8 mm | 4 000 | --- | 20 000 | --- | 10 000 |
| | 0.85±0.1 | 8 mm | 4 000 | --- | 15 000 | --- | 8 000 |
| | 1.25±0.1 | 8 mm | --- | 3 000 | --- | 10 000 | 5 000 |
| CC1206 | 0.6±0.1 | 8 mm | 4 000 | --- | 20 000 | --- | --- |
| | 0.85±0.1 | 8 mm | 4 000 | --- | 15 000 | --- | --- |
| | 1.15±0.1 | 8 mm | --- | 3 000 | --- | 10 000 | --- |
| | 1.6±0.2 | 8 mm | --- | 2 000 | --- | 10 000 | --- |
| CC1210 | 0.6±0.1 | 8 mm | --- | 4 000 | --- | 15 000 | --- |
| | 0.85±0.1 | 8 mm | --- | 4 000 | --- | 10 000 | --- |
| | 1.15±0.1 | 8 mm | --- | 3 000 | --- | 10 000 | --- |
| | 1.15±0.15 | 8 mm | --- | 3 000 | --- | 10 000 | --- |
| | 1.9±0.2 | 8 mm | --- | 2 000 | --- | --- | --- |
| CC1812 | 2.5±0.2 | 8 mm | --- | 1 000 | --- | --- | --- |
| | 0.6/0.85±0.1 | 12 mm | --- | 2 000 | --- | --- | --- |
| | 1.15±0.1 | 12 mm | --- | 1 500 | --- | --- | --- |
| | 1.15±0.15 | 12 mm | --- | 1 500 | --- | --- | --- |
| | 1.6±0.2 | 12 mm | --- | 1 000 | --- | --- | --- |
| | 2.5±0.2 | 12 mm | --- | 1 000 | --- | --- | --- |

INDEX

ALUMINUM ELECTROLYTIC CAPACITORS

MINIATURE ALUMINUM ELECTROLYTIC CAPACITORS

| | | |
|----|--|--------------------------|
| 19 | ST [For Super Miniature]-5mm L | 1,000hrs. at 85°C |
| 21 | S7 [For Super Miniature]-7mm L | 1,000hrs. at 85°C |
| 23 | S5 [For Super Miniature]-5mm L | 1,000hrs. at 105°C |
| 25 | SS [For Super Miniature]-7mm L | 1,000hrs. at 105°C |
| 27 | SK [For General] | 2,000hrs. at 85°C |
| 30 | SE-K [For General] | 1,000hrs. at 105°C |
| 33 | SH [For General] | 2,000hrs. at 105°C |
| 36 | SG [For Electronic Ballast] | 5,000hrs. at 105°C |
| 39 | SA [For High Temperature and Load Life] | 8,000hrs. at 105°C |
| 43 | SP [High Ripple and Long Life] | 10,000hrs. at 105°C |
| 46 | SB [For Low Leakage Current] | 1,000hrs. at 105°C |
| 49 | SR [For Horizontal Deflection] | 1,000hrs. at 85°C |
| 51 | SN [For Non Polar] | 1,000hrs. at 105°C |
| 53 | SC [For Low Impedance and Low E.S.R Suitable for Output of Mother Board] | 2,000~3,000hrs. at 105°C |
| 56 | SM [For very Low Impedance and very Low E.S.R Suitable for Output of Mother Board] | 2,000~3,000hrs. at 105°C |
| 59 | SX [For Low Impedance & Low E.S.R] | 2,000~5,000hrs. at 105°C |
| 63 | SY [For Low Impedance and Low E.S.R Suitable for Output of Mother Board] | 3,000~6,000hrs. at 105°C |
| 66 | SZ [For Ultra Low ESR] | 2,000hrs. at 105°C |
| 68 | SQ [High Temperature for +125°C] | 1,000hrs. at 125°C |
| 70 | SV [For adapter and power supply applications Series] | 2,000hrs. at 105°C |
| 72 | SF [For Photo Flash Application] | 5,000hrs. at 55°C |

LARGE CAN ALUMINUM ELECTROLYTIC CAPACITORS

| | | |
|----|-----------|---------------------|
| 74 | LH Series | 2,000 hrs. at 85°C |
| 79 | LG Series | 2,000 hrs. at 105°C |
| 84 | LV Series | 3,000 hrs. at 105°C |

SURFACE MOUNT ALUMINUM ELECTROLYTIC CAPACITORS

| | | |
|----|-----------|---------------------|
| 88 | CA Series | 2,000 hrs. at 85°C |
| 90 | CB Series | 1,000 hrs. at 105°C |



1-1 Precautions in Using Aluminum Electrolytic Capacitors

Please note the following recommendations when use capacitors:

1. Electrolytic capacitors for DC applications require polarization .

Confirm the polarity before use . The circuit life may be shortened or the capacitor may be damaged if insert in reversed polarity . For use on circuits whose polarity is occasionally reversed , or whose polarity is unknown , use non-polar capacitors . Also note that the electrolytic capacitors cannot be used for AC applications .

2. Do not apply a voltage exceeding the capacitor's voltage rating.

If a voltage exceeding the capacitor's voltage rating is applied , the capacitor may be damaged by increased leakage current . When using the capacitor with AC voltage do not exceed the rated voltage .

3. Do not allow excessive ripple current passing.

Use the electrolytic capacitor at current value within the permissible ripple range . If the ripple exceeds the specified value , request capacitors for high ripple current applications .

4. Ascertain the operation temperature range .

Use the electrolytic capacitors according to the specified operation temperature range . Use at room temperature will ensure a longer life .

5. The electrolytic capacitor is not suitable for circuits which are charged and discharged repeatedly .

If used in circuits which are charged and discharged repeatedly , the capacitance value may drop or the capacitor may be damaged .

Please consult our engineering department for assistance in these applications .

6. When capacitors have been left unused for long time , use them only after due voltage treatments .

Long storage of capacitors tends to rise their leakage current levels . In such cases , be sure to provide the necessary voltage treatment before use .

7. Be careful of temperature and time when soldering .

When soldering a printed circuit board with various components , care must be taken that the soldering temperature is not too high and that the dipping time is not too long .

Otherwise , there will be adverse effect on the electrical characteristics and insulation sleeve of electrolytic capacitors . In the case of small -size electrolytic capacitors , nothing abnormal will be occurred if dipping is performed at less than 260°C for less than 10 seconds .

8. Cleaning circuit boards after soldering .

Halogenated hydrocarbon cleaning solvents are not recommended for use in cleaning capacitors supplied with exposed end seals .

Where cleaning with a halogenated solvent is desired , capacitors should be ordered with an Epoxy-coated end seal .

9. Do not apply excessive force to the lead wires or terminals .

If excessive force is applied to the lead wires and terminals , they may be broken or their connections on the internal elements may be affected . (For strength of terminals , please refer to JIS C5102 and C5141 .)

10. Keep the following clearance between the vent of the capacitor

and the case of the appliance . Do not block the operation of the vent , unless otherwise described on the catalogues or product specifications . The narrower clearance may adversely affect the vent operation and result in an explosion of the capacitor .

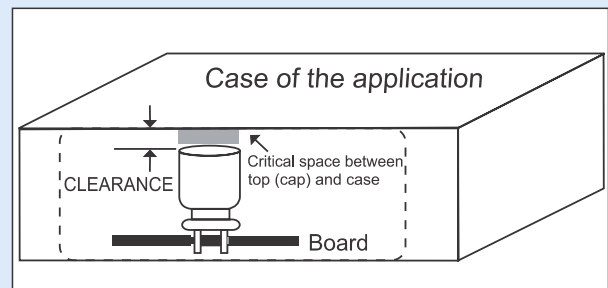

| Case diameter | Clearance |
|------------------|--------------|
| ø 6.3 to ø 16 mm | 2 mm minimum |
| ø 18 to ø 35 mm | 3 mm minimum |
| ø 40 mm & up | 5 mm minimum |

Fig.1-1

Attention

- The description in this catalogue is subject to change without prior notice for product improvement . Therefore , please confirm the specification before ordering products .
- The general characteristics , reliability data , etc . , described in this catalogue should not be construed as guaranteed values , they are merely standard values .
- Before using the products , please read the notes in this catalogue carefully for proper use .

1-2 Technical Concepts

1. The material and structure of Electrolytic Capacitors

Electrolytic Capacitor is a simple module . It simply contains an insulator between relative conductors in an electrode. The major internal raw material contains an element constructed by an separator paper wrap around the anode foil and cathode foil , which is then impregnated with the electrolyte , inserted into an aluminum case and sealed.

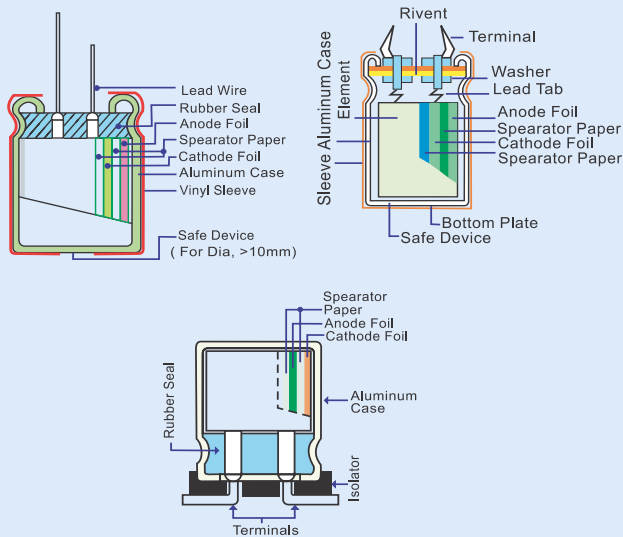

Fig.1-2

2. Production Processes

- Etching :** The process to increase surface area of aluminum foil by using chemical erosion or chemical corrosion method is called Etching . Normally chemical corrosion method uses the ripple current of electrolyte , combination of the liquid and temperature to determine the size, shape , and quantity of the dense network of microscopic channels on the aluminum foil surface .
- Forming :** The production process of the anode aluminum foil of electrolytic capacitors is by anodic oxidation of the etched aluminum foil . The production of the cathode aluminum foil sometimes involves oxidation in special purposes . This anodic oxidation process is called Forming . Boric acid or organic acid is used for high voltage forming and phosphoric acid or ammonium adipate is used for low voltage forming in order to obtain stable natural oxide layer of Al_2O_3 .
- Slitting :** The cutting of the aluminum foil and separator paper according to the required length .
- Winding :** The stitching or cold welding of cut anode and cathode foils and tab terminal , and wrap the electrolytic paper in between the anode and cathode , then fix the end with glue or sticky tape , and attached leads is called the capacitor "element" .
- Impregnation :** The process of eliminating the water from the elements by pressurizes or vacuum in order to soak the element with the electrolyte is called Impregnation . The elements fully filled with electrolyte is then centrifuged to remove excess electrolyte .
- Assembly :** The elements seal with rubber to stop the leakage of electrolyte then slip into a sleeve to form the final product .
- Aging :** The purpose of Aging is to repair the oxide film damage by recharging and electrolyte .

1-3 The Function of Electrolytic Capacitors

The electrolytic capacitors could be widely used in appliance (ie. TV , radio , audio equipment , watching machine and air conditioner.....etc .) , computer equipment (mother board, image device & the peripherals such as the printer , drawing device, scanner etc) , communication equipment , estate equipment , measure instrument and also the industrial instrument , air plane , firebomb , satellite... etc. as a piloting equipment.

*According to the inflict electric wave & using purpose , it basically with some classified purposes as below :

1. DC Voltage :

- For Momentary High Voltage :** For using to the impulse generator such as the shock wave resistance test of the heavy electric machine .
- For High Electric Current :** For using to the welding machine , X- Ray facility , copy machine and discharge processing device .
- For DC High Voltage :** The electrolytic capacitor and rectifier composing , a special DC high voltage been happened after charged , for using to the power of electronic microscope and accelerator .
- For Integration & Memory :** For either memory circuit or compare circuit inside the calculator .

2. The DC voltage that with alternate ingredient :

- For Wave Filter :** Combination with the chip resistor & inductor as a internet , to be past by DC current or some frequency to closure or decline some other frequency .
- For Bypass :** A parallel track that outside from the circuit element , the IC (integrated circuit) has been rapidly developing in this years and thus a miniaturization or chip of electrolytic capacitors for by pass was conducted .
- For Coupling :** Combination of the electrolytic capacitor , chip resistor and inductor and thus coupling together .
- For Arising of Toothed Wave :** Composing of RC charge/discharge circuit through the electrolytic capacitor as well as the resistor and a toothed wave to be created by the RC charge/discharge circuit .
- For Reverse (Change) of Circuit :** The equipment for change the AC voltage to DC voltage .

3. For AC voltage :

- For Power Improving :** Connect the end loading of layout transporting & electrolytic capacitor for power improving .
- For Wave Filter :** Prevention of external interference in SCR circuit , use the LC wave filter circuit to inhibit or erase the interference .
- For Phase Across :** Phase change of the inductive electromotor(motor) with single phase .



1-4 Basic Electrical Characteristics

1. Capacitance (E.S.C.)



Fig.1-3 Simplified equivalent circuit diagram of an electrolytic capacitor

The capacitive component of the equivalent series circuit (equivalent series capacitance ESC) is determined by applying an alternate voltage of 0.5V at a frequency of 120 Hz .

Temperature dependence of the capacitance

The capacitance of an electrolytic capacitor depends on the temperature : with decreasing temperature , the viscosity of the electrolyte increases reducing its conductivity . The capacitance will decrease if the temperature decreases . Furthermore temperature drifts cause armature dilatation and the refore capacitance changes (up to 20% , depending on the series considered, from 0 to 80°C) . This phenomenon is more evident for electrolytic capacitors than for other types .



Fig 1-4 Capacitance change vs. temperature

Frequency dependence of the capacitance

The effective capacitance value is derived from the impedance curve , as long as the impedance is still in the range where the capacitance component is dominant .

$$C = \frac{1}{2\pi f Z}$$

C = Capacitance(F)
f = Frequency(Hz)
Z = Impedance(Ω)



Fig 1-5 Capacitance change vs. frequency

2. Dissipation factor (tanδ)

The dissipation factor is the ratio between the active and the reactive power for a sinusoidal waveform voltage . It can be thought as a measurement of the gap between an actual and an ideal capacitor .



Fig 1-6

$$D.F. = \tan\delta \times 100 (\%) = \omega CR \times 100 (\%) = 2\pi fCR \times 100 (\%)$$

where: R = Equivalent Series Resistance
C = Equivalent Series Capacitance
 $\omega = 2\pi f$

The $\tan \delta$ is measured with the same set up as for the series capacitance ESC .



Fig 1-7 Dissipation factor vs. temperature

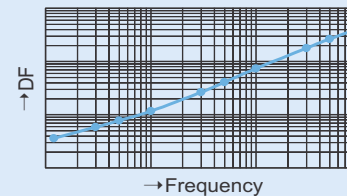

Fig 1-8 Dissipation factor vs. frequency

3. Equivalent series resistance (E.S.R.)

The equivalent series resistance is the resistive component of the equivalent series circuit . The ESR value depends on frequency and temperature and is related to the $\tan \delta$ by the following equation :

$$ESR = \frac{\tan\delta}{2\pi f ESC}$$

ESR = Equivalent Series Resistance (Ω)
 $\tan\delta$ = Dissipation Factor
ESC = Equivalent Series Capacitance (F)
f = Frequency (Hz)

The tolerance limits of the rated capacitance must be taken into account when calculating this value .



Fig 1-9 ESR change vs. temperature

The resistance of the electrolyte decreases strongly with increasing temperature.

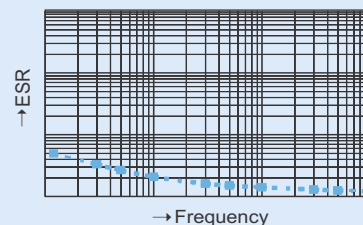

Fig 1-10 ESR change vs. frequency

4. Impedance (Z)

The impedance of an electrolytic capacitor results from here below circuit formed by the following individual equivalent series components :



Fig 1-11

Co = Aluminum oxide capacitance (surface and thickness of the dielectric).

Re = Resistance of electrolyte and paper mixture (other resistances not depending on the frequency are not considered : tabs , plates , and so on).

Ce = Electrolyte soaked paper capacitance.

L = Inductive reactance of the capacitor winding and terminals.

The impedance of an electrolytic capacitor is not a constant quantity that retains its value under all the conditions : it changes depending on the frequency and the temperature .

The impedance as a function of frequency (sinusoidal waveform) for a certain temperature can be represented as follows :

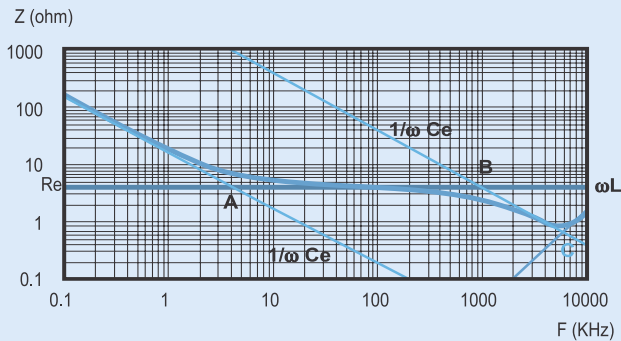

Fig 1-12

- Capacitive reactance predominates at low frequencies
 - With increasing frequency , the Capacitive reactance $X_c = 1/\omega C$ decreases until it reaches the order of magnitude of the electrolyte resistance Re (A)
 - At even higher frequencies , the resistance of the electrolyte predominates : $Z = Re$ (A - B)
 - When the capacitor's resonance frequency is reached ($\omega 0$) , capacitive and cancel each other $1/\omega C$ inductive reactance mutually cancel each other $1/\omega C = \omega L$, $\omega 0 = \text{SQR}(1/LC) (C)$.
 - Above this frequency , the inductive reactance of the winding and its terminals ($X_L = Z = \omega L$) becomes effective and leads to an increase in impedance .
- Generally speaking it can be estimated that $C_e \approx 0.01 C_o$.

The impedance as a function of frequency (sinusoidal waveform) for different temperature values can be represented as follows (typical values) :

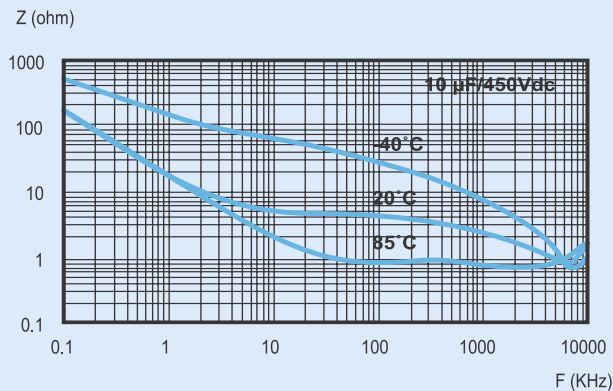

Fig 1-13

Re is the most temperature dependant component of electrolytic capacitor equivalent circuit . The electrolyte resistivity will decrease if the temperature rises . In order to obtain a low impedance value all over the temperature range , Re must be as little as possible , but too low Re values means a very aggressive electrolyte and then a shorter life of the electrolytic capacitor at the high temperatures . A compromise must be reached .

5. Leakage current (L.C.)

Due to the aluminum oxide layer that serves as a dielectric , a small current will continue to flow even after a DC voltage has been applied for long periods . This current is called leakage current . A high leakage current flows after applying a voltage to the capacitor and then decreases in few minutes (e.g. after a prolonged storage without any applied voltage) . In the course of the continuous operation , the leakage current will decrease and reach an almost constant value .

After a voltage free storage the oxide layer may deteriorate , especially at high temperature . Since there are no leakage current to transport oxygen ions to the anode , the oxide layer is not regenerated . The result is that a higher than normal leakage current will flow when a voltage is applied after prolonged storage . As the oxide layer is regenerated in use , the leakage current will gradually decrease to its normal level .

The relationship between the leakage current and the voltage applied at constant temperature can be shown schematically as follows :

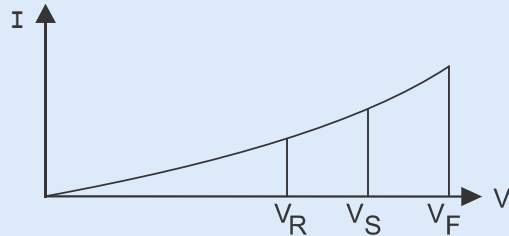

Fig 1-14

Where :

V_F = Forming voltage

If this level is exceeded a large quantity of heat and gas will be generated and the capacitor could be damaged .

V_R = Rated Voltage

This level represents the top of the linear part of the curve .

V_S = Surge voltage

It lies between V_R and V_F : the capacitor can be subjected to V_S for short periods only .



1-5 Reliability

(1) The bathtub curve:

Aluminum electrolytic capacitors feature failure rates shown by the following bathtub curve.



Fig.1-15 Bathtub curve

a. Initial failure period

Deficient Capacitors include any products before dispatch that may have some deficiency caused by the design, production process or used in inappropriate environments.

b. Random failure period

The capacitors have a low defect ratio in the period after it has been stabilized.

c. Wear out failure period

The performance of capacitors will decrease with an increase in usage period. The malfunction rate may vary due to the structural design.

(2) Failure types: (See Table-1)

a). Completely malfunction:

Capacitor is completely disabled to all functions, e.g.: short circuit, open circuit.

b). Malfunction cause by wear and tear gradual malfunctioning of the capacitor, the cause of the malfunction would depend on the environmental conditions.

pressure & vibration... etc. and mostly affected by temperature factor . Electrical condition include voltage , ripple current and charge / discharge condition... etc.

1. Temperature & Life

The reduce capacitance & increase DF will be created by the influence from temperature on the life, such condition mostly caused by a slow evaporation from the electrolyte to seal position; the electric specificity that is affected by timing and surrounding temperature as following formula below and similar to the chemical kinetics of Arrhenius' rule and to be reputed as the connection rule of life in electrolytic capacitors.

$$L_x = L_0 \times B^{\frac{T_0 - T_x}{10}} \quad \text{Eq.1}$$

Lx: Expected Life at Operating Temperature Tx °C (hour)

L0: Load Life at Maximum Operating Temperature To °C (hour)

To: Maximum Operating Temperature (°C)

Tx: Actual Operating Temperature. (°C)

B: Accelerate Coefficient of Temperature (≈ 2)

From the Eq.1 , it means about double acceleration for temperature raising at 10 C . Therefore , it comes a longer working life once a temperature setting lower than Tx while products design .

2. Rated Voltage and Life

While working , the voltage under the input of rated voltage and for the reducing of volt age, although with little or more influence to electrolytic capacitors but, no necessary for special concern after compare with the influence by temperature.

1-6 Life of the Electrolytic Capacitors

A effects by using condition for the life of electrolytic capacitors which environmental condition & electrical condition .

Environmental condition include temperature , humidity , atmospheric

Table-1 Failure modes and causes

| Failure Modes | Internal Causes | Primary Factors | | |
|--------------------------|--|---------------------------------|---|---------------------------------------|
| | | Mismanaged Production | Mishandled Application | Unavoidable Factors in Normal Service |
| Short Circuit | Short Circuit Between Electrodes | Burred Foil/ Metal Particle | Mechanical Stress | Deterioration With Time |
| | Dielectrical Break of Oxide Layer | Local Deficiency in Oxide Layer | | |
| Open Circuit | Dielectrical Break of Separator | Mechanical Stress | Poor Connection | |
| | Disconnection of Terminal Construction | | | |
| Capacitance Drop | Poor Terminal Connection | Electrochemical Reaction | Excessive Thermal Stress | |
| | Less Electrolyte | | | |
| tanδ (ESR) Increase | Electrolyte Vaporization | Excessive Operating Voltage | Reverse Voltage | |
| | Anode Foil Capacitance Drop | | | |
| Leakage Current Increase | Cathode Foil Capacitance Drop | Excessive Ripple Current | Excessive Charge-Discharge Duty | |
| | Deterioration of Oxide Layer | | | |
| Open Vent | Corrosion | Contamination By Chloride | Chloride Contamination By Assembly Board Cleaning | |
| | Internal Pressure Rise | | | |
| Electrolyte Leakage | Poor Sealing | Poor Sealing | | |



1-7 Cleaning Agings

3. Influence of Input Ripple Current Against Working life

Passing of some ripple current when the electrolytic capacitor has a wave filter or smoothing function, the internal temperature of electrolytic capacitor will be brought some more influence to working life as well. Hence, a maximum ripple current will be listed caused by such ripple current and directly specifically by each manufacturer; it has been considered as overlapping by DC voltage & AC voltage when incorporate electrolytic capacitors with a power that ripple current included. The losing electronic power caused by the alternate resistance & direct leakage current inside the electrolytic capacitors will be come to heat. Kindly refer to following for relation between in rated ripple current and temperature raising:

$$W = (I_{\text{Ripple}})^2 \cdot R_{\text{ESR}} + V \cdot I_{\text{Leakage}} \quad \text{Eq.3}$$

where W: Internal power loss

I Ripple : Ripple current

R ESR: Equivalent Series Resistance

V : Applied voltage

I Leakage : Leakage current

Normally the losing voltage power of DC leakage current that caused by the DC voltage which to be inflicted in the electrolytic capacitor will be lower than a losing voltage power caused by ripple current, therefore:

$$W \approx (I_{\text{RIPPLE}})^2 \cdot R_{\text{ESR}} \quad \text{Eq.4}$$

The formula for reaching of temperature balance on the internal temperature raising as well as the hot dissipation as below:

$$W \approx (I_{\text{RIPPLE}})^2 \cdot R_{\text{ESR}} = \beta \cdot A \cdot \Delta T \quad \text{Eq.5}$$

β : Heat radiation constant

A= Surface area of container (cm²)

A= $\pi/4 \cdot D \cdot (D + 4L)$

D: case diameter (cm)

L: case length (cm)

ΔT : Temperature raising created by internal heating (°C).

Through the formula above can see the temperature raising caused by the ripple current and:

$$\Delta T = \frac{(I_{\text{RIPPLE}})^2 \cdot R_{\text{ESR}}}{\beta A} = \frac{(I_{\text{RIPPLE}})^2 \cdot \tan \delta}{\beta A \omega C} \quad \text{Eq.6}$$

$$\text{Due to : } R_{\text{ESR}} = \frac{\tan \delta}{\omega C}$$

Tan δ : DF at 120HZ

ω : $2\pi f$ (f = 120HZ)

C : The static capacity (F) at 120HZ

In general, the allowed ripple current value would be specifically listed by the manufacturer - A revised coefficient of allowed ripple current & working frequency to the electrolytic capacitor.

Table-2 Snap-in terminal type capacitors (for input smoothing circuit)

| Frequency (Hz) | 50 | 60 | 120 | 1K | 10K~100K | |
|----------------|----------|------|------|------|----------|------|
| Frequency | 6.3~100V | 0.88 | 0.90 | 1.00 | 1.15 | 1.16 |
| Coefficient | 160~250V | 0.85 | 0.88 | 1.00 | 1.15 | 1.20 |
| Kf | 315~450V | 0.88 | 0.90 | 1.00 | 1.10 | 1.15 |

Table-3 Lead type capacitors (for output smoothing circuit)

| Frequency (Hz) | 50 | 120 | 300 | 1K | 10K | 100K |
|---------------------|------|------|------|------|------|------|
| ~47 μ F | 0.30 | 0.40 | 0.50 | 0.70 | 0.80 | 1.00 |
| 5.6~33 μ F | 0.40 | 0.50 | 0.60 | 0.80 | 0.90 | 1.00 |
| 34~330 μ F | 0.60 | 0.70 | 0.80 | 0.90 | 0.95 | 1.00 |
| 331~1000 μ F | 0.65 | 0.90 | 0.90 | 0.98 | 1.00 | 1.00 |
| 1200 μ F~Higher | 0.85 | 0.90 | 0.95 | 0.98 | 1.00 | 1.00 |

Table-4 The coefficient between allowed ripple current & working temperature to the electrolytic capacitors.

| Surrounding Temp[°C] | Revised coefficient of Temperature | | | | |
|-----------------------|------------------------------------|------|------|------|------|
| | 60 | 65 | 70 | 85 | 105 |
| Snap-in terminal type | 2.37 | | 2.17 | 1.67 | 1.00 |
| Lead type capacitors | | 1.80 | | 1.50 | 1.00 |

Circuit Board Cleaning

1. Foreword

When a halide substance seeps into the aluminum electrolytic capacitor The halide dissolves and frees halogen ions.



Also the following reaction can occur



When this reaction is repeated. The leakage current increases and the safety vent will be activated and may lead to open vent. Because of this halogen type cleaning agents or adhesive material and coating material is not recommended for usage. The following explains the recommended condition for cleaning. When a halogen type cleaning agent will be used due to cleaning capabilities.

2. Recommended Cleaning Condition

Applicable : Any type.any ratings

Cleaning Agents : Pine Alpha ST-100S

Clean Through 750H,750L,710M

Sanelek B-12

Aquq Cleaner 210 SEP

Techno Care FRw 14~17

Isopropyl Alcohol

Cleaning Conditions : Total cleaning time shall be no greater than 5 minutes by immersion, ultrasonic or other method.

After cleaning, capacitors should be dried using hot air for minimum of 10 minutes along with the PC board.

Hot air temperature should be below the maximum operating temperature of the capacitor.

Insufficient dries after water runse may cause appearance problems, such as sleeve shrinking, bottom-plate bulging.

It is recommended to monitor conductivity, pH, and concentration of the agent. Please do not keep a product after cleaning in condition that cleaning agents exists as steam, or in non ventilated containers.

3. CFC substitute

The anti-solvent capacitor listed in the catalogue can be cleaned using AK-255AES. If used within the following condition.

Please monitor contamination of solution by measuring conductivity, pH, specific gravity, water content and such.

Furthermore, do not store capacitors in a cleaning agent atmosphere or sealed container after cleaning.

Also avoid using using ozone depleting substances for cleaning agents in difference to our global environments.

Applicable : Anti-solvent capacitors

Cleaning Agents : AK-255AES

Cleaning Conditions : Within 5 minutes, total cleaning time by immersion, vapor spray, or ultrasonic and such. For SMD and ultra-miniature type 2 minutes maximum of total cleaning time.

4. Fixing Material and Coating Material

- DO not use any affixing or coating materials, which contain halide substance.
- Remove flux and any contamination, which remains in the gap between the end seal and PC board.
- Remove flux and any contamination, which remains in the gap between the end seal and PC board.
- Please dry the cleaning agent on the PC board before using affixing or coating material.
- Please do not apply any material all around the end seal when using affixing or coating material.

There are variations of cleaning agents, fixing and coating material, so please contact those manufacture or our sales office to make sure that the material would not cause any problems.



RADIAL TYPE ORDERING CODE

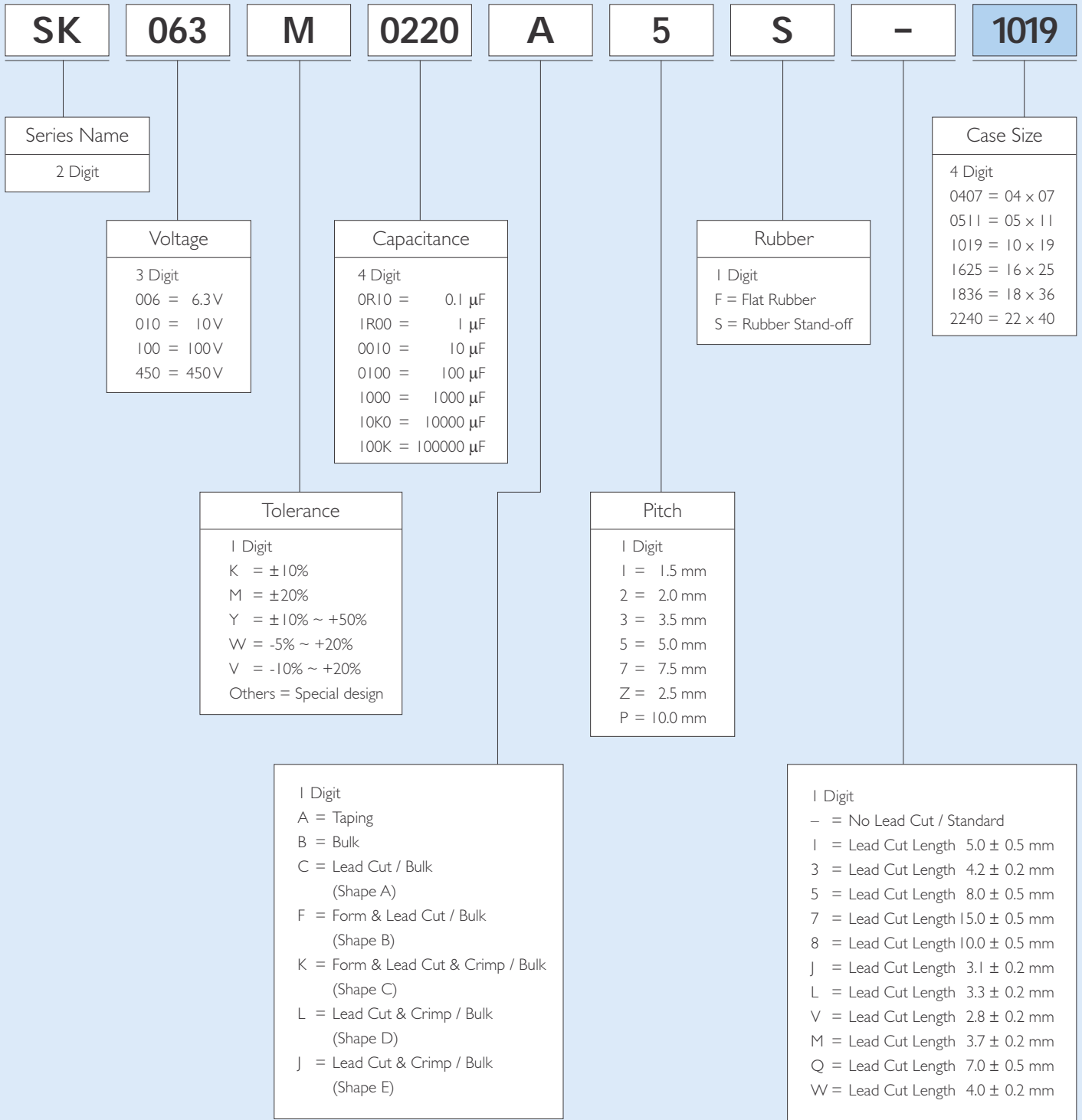



SNAP IN TYPE ORDERING CODE





SMD TYPE ORDERING CODE





DIAGRAM OF TAPING DIMENSIONS

Unit : mm

Fig. 1



Fig. 4



Fig. 2



Fig. 5



Fig. 3

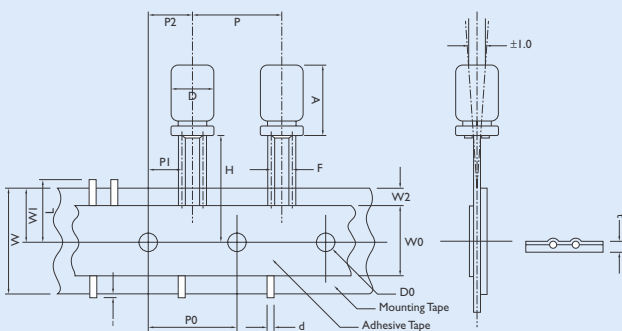
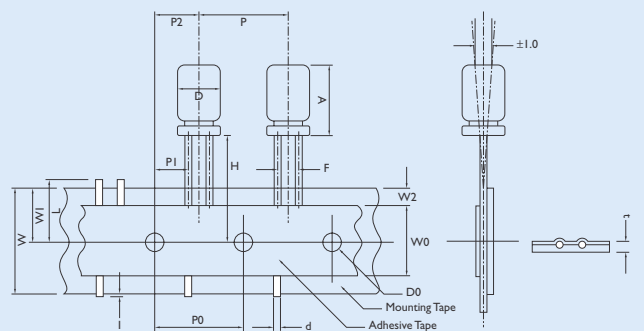

Fig. 6





SPECIFICATIONS INFORMATION

Unit : mm

| ITEM | TOLERANCE | PH = 2.5 | | FORMED LEAD TYPE | | | | | | STRAIGHT LEAD TYPE | | | | | | | | | | |
|-------------|------------|----------|-------|------------------|-------|-------|-------|-------|------|--------------------|-------|-------|-------|-------|-------|-------------|-------|-----|-----------|--|
| | | L | | L | | | | | | L | | | | | | | | | | |
| | | 5~7 | ≤7 >7 | 5~7 | ≤7 >7 | ≤7 >7 | ≤7 >7 | ≤7 >7 | 5~7 | ≤7 >7 | ≤7 >7 | ≤7 >7 | ≤7 >7 | ≤7 >7 | 12-25 | 15-25 | 15-25 | | | |
| D | +0.5 -0 | 4ø | 5ø | 4ø | 5ø | 6ø | 8ø | | 4ø | 5ø | 6ø | 8ø | | 10ø | 12ø | 12.5ø | 13ø | 16ø | 18ø | |
| A | Max. | 8.0 | 13 | 8.0 | 13 | 8.0 | 13 | 8.0 | 22.0 | 8.0 | 13 | 8.0 | 13 | 8.0 | 22.0 | 27.0 | | | | |
| d | ±0.05 | 0.45 | 0.5 | 0.45 | 0.5 | 0.5 | 0.5 | 0.5 | 0.5 | 0.45 | 0.5 | 0.5 | 0.5 | 0.5 | 0.5 | 0.6 | | | 0.8 | |
| P | ±1.0 | 12.7 | | 12.7 | | | | | | 12.7 | | | | | | | 15.0 | | 30.0 | |
| P0 | ±0.3 | 12.7 | | 12.7 | | | | | | 12.7 | | | | | | | 15.0 | | | |
| P1 | ±0.7 | 5.1 | | 3.85 | | | | | | 5.6 | 5.35 | 5.1 | 4.6 | 3.85 | | | | | 3.75 | |
| P2 | ±1.3 | 6.35 | | 6.35 | | | | | | 6.35 | | | | | | 7.5 | | | | |
| F | +0.8, -0.2 | 2.5 | | 5.0 | | | | | | 1.5 | 2.0 | 2.5 | 3.5 | 5.0 | | | | | 7.5 ± 0.8 | |
| W | +1.0, -0.5 | 18.0 | | 18.0 | | | | | | 18.0 | | | | | | | | | | |
| W0 | ±0.5 | 12.0 | | 12.0 | | | | | | 12.0 | | | | | | | | | | |
| W1 | ±0.5 | 9.0 | | 9.0 | | | | | | 9.0 | | | | | | | | | | |
| W2 | Max. | 3.0 | | 3.0 | | | | | | 3.0 | | | | | | | | | | |
| H | ±0.75 | 18.5 | | 18.5 | | | | | | 18.5 | | | | | | | | | | |
| H0 | ±0.5 | 16.0 | | 16.0 | | | | | | | | | | | | | | | | |
| I | Max. | - | | - | | | | | | | | | | 1.0 | | | | | | |
| D0 | ±0.2 | 4.0 | | 4.0 | | | | | | 4.0 | | | | | | | | | | |
| t | ±0.2 | 0.7 | | 0.7 | | | | | | 0.7 | | | | | | | | | | |
| L | Max. | 11.0 | | 11.0 | | | | | | 11.0 | | | | | | | | | | |
| Fig. | | 4 | | 1 | | | | | | 2 | | | | | | 3, 6 | | | 5 | |



DIAGRAM OF LEAD CUTTING AND FORMING

Unit : mm

Shape (A)

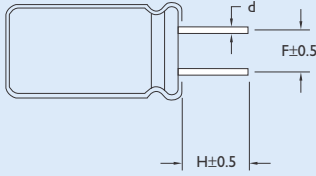

Shape (C)

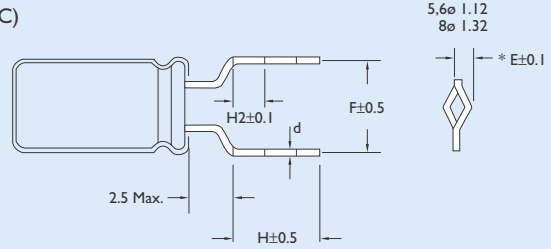

Shape (B)



Shape (D)

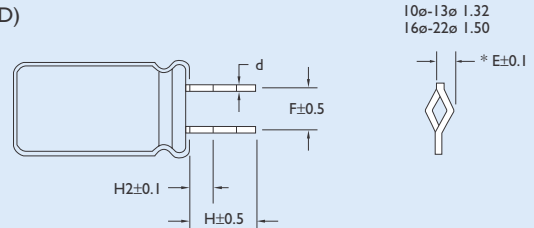

Shape (E)

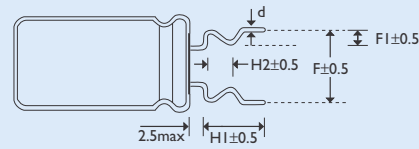

SPECIFICATIONS INFORMATION

Unit : mm

NO.CUTTING &

| FORMING METHODS | | Dø | 4ø | 5ø | 6ø | 8ø | 10ø | 12ø | 13ø | 16ø | 18ø | 22ø | | | |
|-----------------|--------------------------|----|------|-----|-----|-----|-----|-----|-----|-----|-----|-----|-----|-----|-----|
| A | Lead Cut Only | F | 1.5 | 2.0 | 2.5 | 3.5 | 5.0 | 5.0 | 5.0 | 7.5 | 7.5 | 10 | | | |
| | | H | 5.0 | 5.0 | 5.0 | 5.0 | 5.0 | 5.0 | 5.0 | 5.0 | 5.0 | 5.0 | | | |
| | | d | 0.45 | 0.5 | 0.5 | 0.5 | 0.6 | 0.6 | 0.6 | 0.8 | 0.8 | 0.8 | | | |
| B | Lead Cut and Form | F | 5.0 | 5.0 | 5.0 | 5.0 | | | | | | | | | |
| | | H | 5.0 | 5.0 | 5.0 | 5.0 | | | | | | | | | |
| | | d | 0.45 | 0.5 | 0.5 | 0.5 | | | | | | | | | |
| C | Lead Cut, Crimp and Form | F | 5.0 | 5.0 | 5.0 | 5.0 | 5.0 | 5.0 | 5.0 | 5.0 | 5.0 | 5.0 | | | |
| | | H1 | 5.0 | 4.2 | 5.0 | 4.2 | 4.0 | 5.0 | 4.2 | 4.0 | 5.0 | 4.2 | 4.0 | | |
| | | H2 | 2.5 | 2.0 | 2.5 | 2.0 | 2.0 | 2.5 | 2.0 | 2.0 | 2.5 | 2.0 | 2.0 | | |
| | | d | 0.45 | 0.5 | 0.5 | 0.5 | 0.5 | 0.5 | 0.5 | 0.5 | 0.5 | 0.5 | 0.5 | | |
| D | Lead Cut and Crimp | F | | | | | 5.0 | 5.0 | 5.0 | 7.5 | 7.5 | 7.5 | 10 | | |
| | | H1 | | | | | 5.0 | 4.2 | 4.0 | 5.0 | 4.2 | 4.0 | 5.0 | 4.2 | 4.0 |
| | | H2 | | | | | 2.5 | 2.0 | 2.0 | 2.5 | 2.0 | 2.0 | 2.5 | 2.0 | 2.0 |
| | | d | | | | | 0.6 | 0.6 | 0.6 | 0.8 | 0.8 | 0.8 | | | |
| E | Lead Cut Form and Crimp | F | 5.0 | 5.0 | 5.0 | 5.0 | | | | | | | | | |
| | | F1 | 1.2 | 1.2 | 1.2 | 1.2 | | | | | | | | | |
| | | H1 | 4.0 | 4.0 | 4.0 | 4.0 | | | | | | | | | |
| | | H2 | 1.8 | 1.8 | 1.8 | 1.8 | | | | | | | | | |
| | | d | 0.45 | 0.5 | 0.5 | 0.5 | | | | | | | | | |



PACKAGE INFORMATION

| TYPE | D x L | BULK | | | TAPING | | LEAD CUTTING | | |
|-------|---------|-----------|-------------|----------|-------------|----------|--------------|-------------|----------|
| | | I BAG/PCS | I INNER BOX | I CARTON | I INNER BOX | I CARTON | I BAG/PCS | I INNER BOX | I CARTON |
| RADIL | (mm) | | | | | | | | |
| | 04 x 05 | 1000 | 10,000 | 20,000 | 2,500 | 25,000 | 1000 | 15,000 | 30,000 |
| | 05 x 05 | 1000 | 10,000 | 20,000 | 2,000 | 20,000 | 1000 | 15,000 | 30,000 |
| | 06 x 05 | 1000 | 10,000 | 20,000 | 2,000 | 20,000 | 1000 | 15,000 | 30,000 |
| | 04 x 07 | 1000 | 10,000 | 20,000 | 2,500 | 25,000 | 1000 | 15,000 | 30,000 |
| | 05 x 07 | 1000 | 10,000 | 20,000 | 2,000 | 20,000 | 1000 | 15,000 | 30,000 |
| | 06 x 07 | 1000 | 10,000 | 20,000 | 2,000 | 20,000 | 1000 | 15,000 | 30,000 |
| | 05 x 11 | 500 | 10,000 | 20,000 | 2,000 | 20,000 | 500 | 15,000 | 30,000 |
| | 06 x 11 | 500 | 10,000 | 20,000 | 2,000 | 20,000 | 500 | 15,000 | 30,000 |
| | 08 x 11 | 500 | 6,000 | 12,000 | 1,000 | 10,000 | 500 | 8,000 | 16,000 |
| | 08 x 15 | 500 | 5,000 | 10,000 | 1,000 | 10,000 | 500 | 5,000 | 10,000 |
| | 08 x 20 | 200 | 4,000 | 8,000 | 1,000 | 10,000 | 200 | 4,000 | 8,000 |
| | 10 x 12 | 200 | 4,000 | 8,000 | 700 | 7,000 | 200 | 4,000 | 8,000 |
| | 10 x 15 | 200 | 3,000 | 6,000 | 700 | 7,000 | 200 | 4,000 | 8,000 |
| | 10 x 16 | 200 | 3,000 | 6,000 | 700 | 7,000 | 200 | 4,000 | 8,000 |
| | 10 x 19 | 200 | 2,400 | 4,800 | 700 | 7,000 | 200 | 3,000 | 6,000 |
| | 10 x 25 | 200 | 2,400 | 4,800 | 700 | 7,000 | 200 | 2,400 | 4,800 |
| | 10 x 27 | 200 | 2,000 | 4,000 | | | 200 | 2,000 | 4,000 |
| | 10 x 30 | 200 | 2,000 | 4,000 | | | 200 | 2,000 | 4,000 |
| | 12 x 20 | 200 | 2,000 | 4,000 | 500 | 5,000 | 200 | 2,000 | 4,000 |
| | 12 x 25 | 200 | 1,800 | 3,600 | 500 | 5,000 | 200 | 1,800 | 3,600 |
| | 12 x 30 | 200 | 1,600 | 3,200 | 500 | 5,000 | 200 | 1,600 | 3,200 |
| | 12 x 35 | 200 | 1,000 | 2,000 | 500 | 5,000 | | 500 | 3,000 |
| | 12 x 40 | 200 | 1,000 | 2,000 | 500 | 5,000 | | 500 | 3,000 |
| | 13 x 20 | 200 | 1,800 | 3,600 | 500 | 5,000 | 200 | 1,800 | 3,600 |
| | 13 x 25 | 200 | 1,400 | 2,800 | 500 | 5,000 | 200 | 1,400 | 2,800 |
| | 13 x 30 | 200 | 1,200 | 2,400 | 500 | 5,000 | | 500 | 3,000 |
| | 13 x 40 | 200 | 1,000 | 2,000 | 500 | 5,000 | | 500 | 3,000 |
| | 16 x 25 | 200 | 1,000 | 2,000 | 300 | 3,000 | | 500 | 4,000 |
| | 16 x 32 | 200 | 800 | 1,600 | | | | 500 | 3,000 |
| | 16 x 36 | 200 | 600 | 1,200 | | | | 500 | 3,000 |
| | 16 x 40 | 200 | 600 | 1,200 | | | | 500 | 3,000 |
| | 18 x 20 | 200 | 800 | 1,600 | | | 200 | 1,000 | 2,000 |
| | 18 x 25 | 200 | 800 | 1,600 | | | | 500 | 2,000 |
| | 18 x 32 | 100 | 500 | 1,000 | | | | 500 | 2,000 |
| | 18 x 36 | 100 | 500 | 1,000 | | | | 500 | 2,000 |
| | 18 x 40 | 100 | 500 | 1,000 | | | | 500 | 2,000 |
| | 22 x 40 | 100 | 300 | 600 | | | | 400 | 800 |

| TYPE | D x L | BULK | | |
|---------|--------------|-----------|-------------|----------|
| | | I BAG/PCS | I INNER BOX | I CARTON |
| SNAP-IN | (mm) | | | |
| | 22 x 25 ~ 45 | | 400 | 800 |
| | 25 x 25 ~ 50 | | 200 | 400 |
| | 30 x 25 ~ 35 | | 200 | 400 |
| | 30 x 40 ~ 50 | | 200 | 400 |
| | 35 x 30 ~ 50 | | 200 | 400 |



1. Carrier Tape Dimension

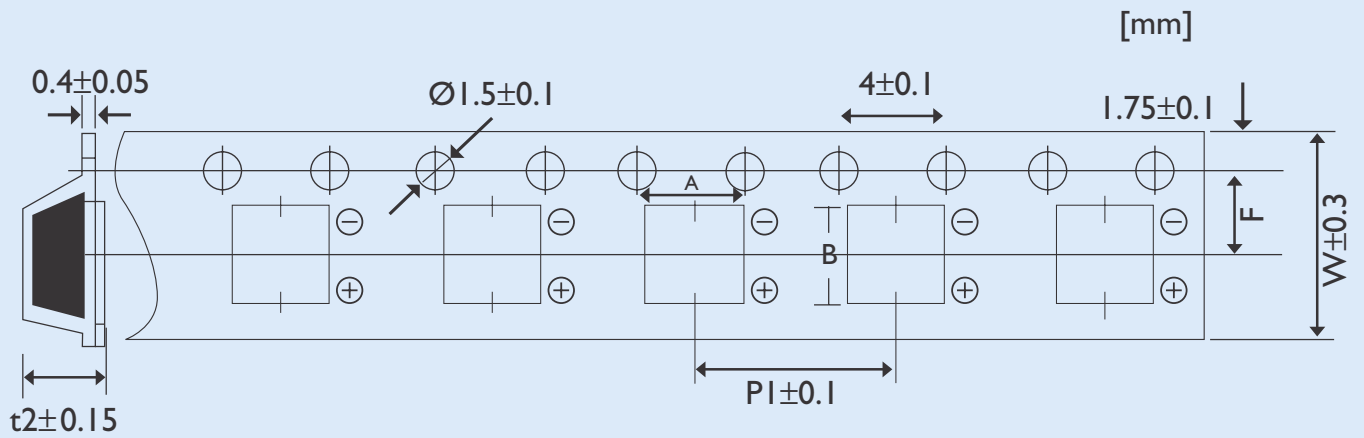

| CASE SIZE | (\varnothing D mm) | W | A | B | P1 | F | t2 |
|-----------|------------------------------|------|------|------|------|------|------|
| B | $\varnothing 4$ | 12.0 | 4.7 | 4.7 | 8.0 | 5.5 | 5.75 |
| C | $\varnothing 5$ | 12.0 | 5.7 | 5.7 | 12.0 | 5.5 | 5.8 |
| D | $\varnothing 6.3 \times 5.4$ | 16.0 | 7.0 | 7.0 | 12.0 | 7.5 | 5.75 |
| E | $\varnothing 8 \times 6.2$ | 16.0 | 8.7 | 8.7 | 12.0 | 7.5 | 6.8 |
| F | $\varnothing 8 \times 10.2$ | 24.0 | 8.7 | 8.7 | 16.0 | 11.5 | 11.0 |
| G | $\varnothing 10 \times 10.2$ | 24.0 | 10.7 | 10.7 | 16.0 | 11.5 | 11.0 |
| H | $\varnothing 6.3 \times 7.7$ | 16.0 | 7.0 | 7.0 | 12.0 | 7.5 | 8.0 |

2. Reel Dimension



| SIZE CODE | B | C | D | E | F | G |
|-----------|----|----|----|----|----|----|
| W1 | 14 | 14 | 18 | 18 | 26 | 26 |
| W2 | 18 | 18 | 22 | 22 | 30 | 30 |



3. Details of Carrier Tape



- (1)
 - a. Last reeling empty part of carrier tape shall be more than .10 cm
 - b. Leader part of seal tape shall be more than 20 cm.
 - c. First reeling Empty part of carrier tape shall be more than 10 cm
 - d. Adhesive tape fixing the end of the leader part shall be approx .10 cm

- (2) Deviation between carrier tape and seal tape
 - a. Deviation between carrier tape and seal tape shall be less than 0.5 mm.



- b. Seal tape shall not cover on the feeding holes more than 0.75 mm.



4. Adhesion Test

Reasonable pulling strength: 0.1~0.7N
Pulling speed: 300mm / min



5. Packing Style

- (1) Carrier tape shall be reeled inside.(seal tape shall be outside)
- (2) End of the tape shall be inside to the reel physically as shown in the below figure and leader part of seal tape shall not be attached.



6. Packaging Quantity

| Size Code | D x L | One Reel (pcs) | Total Quantity pcs) |
|-----------|---------|----------------|---------------------|
| B | 4x5.4 | 2000 | 20000 |
| C | 5x5.4 | 1000 | 10000 |
| D | 6.3x5.4 | 1000 | 10000 |
| E | 6.3x7.7 | 1000 | 10000 |
| F | 8x6.2 | 1000 | 10000 |
| G | 8x10.2 | 500 | 3000 |
| H | 10x10.2 | 500 | 3000 |



Reflow soldering for chip capacitors

- (1) For reflow, use a thermal conduction system such as infrared radiation (IR) or hot blast. Vapor heat transfer systems (VPS) are not recommended.
- (2) Observe proper soldering conditions (temperature, time, etc.). Do not exceed the specified limits.
- (3) Reflow should be performed one time. Consult us for additional reflow restrictions.
- (4) Reflow soldering profile for standard :



- (5) Reflow soldering profile for lead free :



Manual Soldering

- (1) Observe temperature and time soldering specifications or do not exceed temperatures of 300°C for 3 seconds or less.
- (2) If a soldered capacitor must be removed and reinserted, avoid excessive stress on the capacitor leads.

Capacitor handling after soldering

- (1) Avoid moving the capacitor after soldering to prevent excessive stress on the lead wires where they enter the seal.
- (2) Do not use the capacitor as a handle when moving the circuit board assembly.
- (3) Avoid striking the capacitor after assembly to prevent failure due to excessive shock.

Miniature Size Aluminum Electrolytic Capacitors

ST [For Super Miniature]

85°C Single-Ended Lead, 5.0mm Height Type Aluminum Electrolytic Capacitors

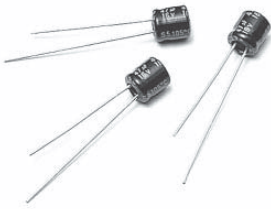

DESCRIPTION

This type is designed for saving space and high density insertion.

Applications : VTR, Camera, Car Audio, Mini Audio and Other Industrial and Commercial Applications

| Cap(μF) \ Freq.(Hz) | 50 | 120 | 300 | 1K | 10K- |
|---------------------|------|------|------|------|------|
| ~47 | 0.75 | 1.00 | 1.35 | 1.57 | 2.00 |
| 100~300 | 0.80 | 1.00 | 1.23 | 1.34 | 1.50 |

Temperature coefficient

| Temperature(°C) | -55 | 60 | 70 | 85 |
|-----------------|------|------|------|------|
| Factor | 1.65 | 1.50 | 1.30 | 1.00 |

DIAGRAM OF DIMENSIONS



ELECTRICAL CHARACTERISTICS

Operating Temperature : -40° ~ +85°C

Working Voltage : 4 ~ 50V

Rate Capacitance Range : 0.1 ~ 330μF

Capacitance Tolerance : -20 ~ +20%

DC Leakage Current (μA) : I = 0.01CV (μA) or 3μA Whichever is greater.

(After 2 Minutes Application of DC Working Voltage at 25°C)

Dissipation Factor : at 120 Hz, 25°C

| WV (V) | 4 | 6.3 | 10 | 16 | 25 | 35 | 50 |
|---------|-------|-----|----|----|----|----|----|
| D.F (%) | ø3 | 40 | 38 | 30 | 23 | 17 | 13 |
| | ø4~ø8 | 35 | 24 | 20 | 16 | 14 | 10 |

Load Life : 1000 Hours at 85°C Assured with Full Rated Maximum Ripple Current Applied

- (a) Capacitance Change : Within 20% of Initial Value
- (b) Dissipation Factor : Not Exceed 200% of Initial Requirement
- (c) Leakage Current : Not Exceed the Initial Requirement

Shelf Life : 500 Hours, No Voltage Applied, at 85°C

- (a) Capacitance Change : Within 20% of Initial Value
- (b) Dissipation Factor : Not Exceed 200% of Initial Requirement
- (c) Leakage Current : Not Exceed 200% of Initial Requirement

Dimensions : mm

Rubber Stand-off

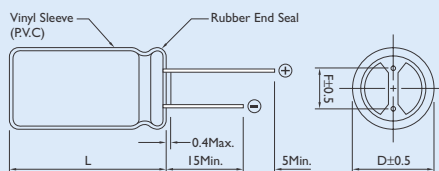

L ≤ 12 L + 1.5Max.
 13 ≤ L ≤ 15 L +1.0
 L -0.5
 L ≥ 16 L + 2.0Max.

| Dø | F | dø |
|-----|-----|------|
| 4.0 | 1.5 | 0.45 |
| 5.0 | 2.0 | |
| 6.3 | 2.5 | |
| 8.0 | 3.5 | 0.5 |



CASE SIZE & PERMISSIBLE RIPPLE CURRENT OF STANDARD PRODUCTS

CAP. (μF) RATED VOLTAGE WV

| | 4 | | 6.3 | | 10 | | 16 | | 25 | | 35 | | 50 | | |
|------|-------|--------|----------------|----------|-------|--------|-------|--------|-------|--------|-------|--------|-------|--------|----|
| | Size | Ripple | Size | Ripple | Size | Ripple | Size | Ripple | Size | Ripple | Size | Ripple | Size | Ripple | |
| 0.1 | | | | | | | | | | | | | 4 × 5 | 1.0 | |
| 0.22 | | | | | | | | | | | | | 4 × 5 | 2.0 | |
| 0.33 | | | | | | | | | | | | | 4 × 5 | 2.8 | |
| 0.47 | | | | | | | | | | | | | 4 × 5 | 4.0 | |
| 1.0 | | | | | | | | | | | | | 4 × 5 | 8.4 | |
| 2.2 | | | | | | | | | | | | 3 × 5 | 8.4 | 4 × 5 | 13 |
| 3.3 | | | | | | | | | 3 × 5 | 10 | 4 × 5 | 15 | 4 × 5 | 17 | |
| 4.7 | | | | | | | 3 × 5 | 10 | 4 × 5 | 16 | 4 × 5 | 18 | 5 × 5 | 20 | |
| 10 | | | 3 × 5 | 15 | | | 4 × 5 | 23 | 5 × 5 | 27 | 5 × 5 | 29 | 6 × 5 | 33 | |
| 22 | 3 × 5 | 19 | 4 × 5 | 28 | 5 × 5 | 33 | 5 × 5 | 37 | 6 × 5 | 42 | 6 × 5 | 46 | 8 × 5 | 52 | |
| 33 | 4 × 5 | 28 | 4 × 5 5 × 5 | 37 37 | 5 × 5 | 41 | 6 × 5 | 49 | 6 × 5 | 52 | 8 × 5 | 62 | 8 × 5 | 71 | |
| 47 | 4 × 5 | 33 | 4 × 5 5 × 5 | 45 45 | 6 × 5 | 52 | 6 × 5 | 58 | 8 × 5 | 70 | 8 × 5 | 80 | | | |
| 100 | 5 × 5 | 56 | 6 × 5 | 70 | 8 × 5 | 80 | 8 × 5 | 92 | 8 × 5 | 110 | | | | | |
| 220 | 6 × 5 | 96 | 8 × 5 | 110 | 8 × 5 | 135 | | | | | | | | | |
| 330 | 8 × 5 | 145 | | | | | | | | | | | | | |

Note : * 1. D × L : mm

* 2. Size : 6 × 5 Actually is 6.3 × 5

* 3. mA rms at 85°C, 120Hz

Miniature Size Aluminum Electrolytic Capacitors

S7 [For Super Miniature]

85°C Single-Ended Lead, 5.0mm Height Type Aluminum Electrolytic Capacitors



DESCRIPTION

This type is designed to meet the demand or equipments for greatly reduced size and thickness. such as: portable micro computer; disk driver; small calculator and audio equipment.

Frequency coefficient

| Cap(μF) \ Freq.(Hz) | 50 | 120 | 300 | 1K | 10K- |
|---------------------|------|------|------|------|------|
| ~47 | 0.75 | 1.00 | 1.35 | 1.57 | 2.00 |
| 100~470 | 0.80 | 1.00 | 1.23 | 1.34 | 1.50 |

Temperature coefficient

| Temperature(°C) | -55 | 60 | 70 | 85 |
|-----------------|------|------|------|------|
| Factor | 1.65 | 1.50 | 1.30 | 1.00 |

DIAGRAM OF DIMENSIONS



ELECTRICAL CHARACTERISTICS

Operating Temperature : -40° ~ +85°C

Working Voltage : 4 ~ 50V

Rate Capacitance Range : 0.1 ~ 470μF

Capacitance Tolerance : -20 ~ +20%

DC Leakage Current (μA) : I = 0.01 CV (μA) or 3μA. Whichever is greater.

(After 2 Minutes Application of DC Working Voltage at 25°C)

Dissipation Factor : at 120 Hz, 25°C

| | | | | | | | |
|-----------|----|-----|----|----|----|----|----|
| WV (V) : | 4 | 6.3 | 10 | 16 | 25 | 35 | 50 |
| D.F (%) : | 35 | 24 | 20 | 16 | 14 | 12 | 10 |

Load Life : 1000 Hours at 85°C Assured with Full Rated Maximum Ripple Current Applied

- (a) Capacitance Change : Within 20% of Initial Value
- (b) Dissipation Factor : Not Exceed 200% of Initial Requirement
- (c) Leakage Current : Not Exceed the Initial Requirement

Shelf Life : 500 Hours, No Voltage Applied, at 85°C

- (a) Capacitance Change : Within 20% of Initial Value
- (b) Dissipation Factor : Not Exceed 200% of Initial Requirement
- (c) Leakage Current : Not Exceed 200% of Initial Requirement

Dimensions : mm

Rubber Stand-off



L ≤ 12 L + 1.5Max.
 13 ≤ L ≤ 15 L +1.0
 L -0.5
 L ≥ 16 L + 2.0Max.

| Dø | F | dø |
|-----|-----|------|
| 4.0 | 1.5 | 0.45 |
| 5.0 | 2.0 | |
| 6.3 | 2.5 | |
| 8.0 | 3.5 | 0.5 |



CASE SIZE & PERMISSIBLE RIPPLE CURRENT OF STANDARD PRODUCTS

| CAP. (μF) | RATED VOLTAGE WV | | | | | | | | | | | |
|-----------|------------------|--------|-------|--------|-------|--------|-------|--------|-------|--------|-------|--------|
| | 6.3 | | 10 | | 16 | | 25 | | 35 | | 50 | |
| | Size | Ripple | Size | Ripple | Size | Ripple | Size | Ripple | Size | Ripple | Size | Ripple |
| 0.1 | | | | | | | | | | | 4 × 7 | 10 |
| 0.22 | | | | | | | | | | | 4 × 7 | 2.3 |
| 0.33 | | | | | | | | | | | 4 × 7 | 3.5 |
| 0.47 | | | | | | | | | | | 4 × 7 | 5.0 |
| 1.0 | | | | | | | | | | | 4 × 7 | 10 |
| 2.2 | | | | | | | | | | | 4 × 7 | 19 |
| 3.3 | | | | | | | | | | | 4 × 7 | 24 |
| 4.7 | | | | | | | | | 4 × 7 | 24 | 4 × 7 | 28 |
| 10 | | | | | 4 × 7 | 28 | 4 × 7 | 28 | 4 × 7 | 31 | 5 × 7 | 38 |
| 22 | 4 × 7 | 34 | 4 × 7 | 35 | 4 × 7 | 39 | 5 × 7 | 48 | 5 × 7 | 52 | 6 × 7 | 58 |
| 33 | 4 × 7 | 40 | 4 × 7 | 43 | 5 × 7 | 59 | 5 × 7 | 58 | 6 × 7 | 65 | 8 × 7 | 75 |
| 47 | 4 × 7 | 48 | 5 × 7 | 59 | 5 × 7 | 65 | 6 × 7 | 71 | 8 × 7 | 85 | | |
| 100 | 5 × 7 | 78 | 6 × 7 | 87 | 6 × 7 | 98 | 8 × 7 | 115 | | | | |
| 220 | 6 × 7 | 120 | 8 × 7 | 145 | | | | | | | | |
| 330 | 8 × 7 | 180 | 8 × 7 | 201 | | | | | | | | |
| 470 | 8 × 7 | 215 | | | | | | | | | | |

Note : * 1. D × L : mm

* 2. Size : 6 × 7 Actually is 6.3 × 7

* 3. mA rms at 85°C, 120Hz

Miniature Size Aluminum Electrolytic Capacitors

S5 [For Super Miniature]

105°C Single-Ended Lead, 5.0mm Height Type Aluminum Electrolytic Capacitors

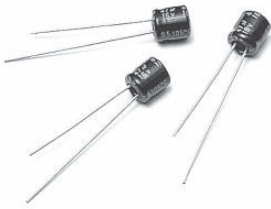

DESCRIPTION

The S5 series are smaller than SS series.

This type is designed for saving space and high density insertion.

Applications : VTR, Camera, Car Audio, Miniaudio and Other Industrial and Commercial Applications

Multiplier for Ripple Current

Frequency coefficient

| Frequency (Hz) | 20 | 300 | 1K | 10K~100K |
|-----------------|------|------|------|----------|
| 0.1~47 μ F | 1.00 | 1.20 | 1.30 | 1.50 |
| 100~330 μ F | 1.00 | 1.10 | 1.15 | 1.20 |

Temperature coefficient

| Temperature(°C) | 65 | 85 | 105 |
|-----------------|------|------|------|
| Factor | 1.40 | 1.20 | 1.00 |

DIAGRAM OF DIMENSIONS



ELECTRICAL CHARACTERISTICS

Operating Temperature : -40° ~ +105°C

Working Voltage : 6.3 ~ 50V

Rate Capacitance Range : 0.1 ~ 470 μ F

Capacitance Tolerance : -20 ~ +20%

DC Leakage Current (μ A) : I = 0.01 CV (μ A) or 3 μ A Which ever is greater.

(After 2 Minutes Application of DC Working Voltage at 25°C)

Dissipation Factor : at 120 Hz, 25°C

| | | | | | | |
|-----------|-----|----|----|----|----|----|
| WV (V) : | 6.3 | 10 | 16 | 25 | 35 | 50 |
| D.F (%) : | 24 | 20 | 16 | 14 | 12 | 10 |

Load Life : 1000 Hours at 105°C Assured with Full Rated Maximum Ripple Current Applied

- (a) Capacitance Change : Within 20% of Initial Value
- (b) Dissipation Factor : Not Exceed 200% of Initial Requirement
- (c) Leakage Current : Not Exceed the Initial Requirement

Shelf Life : 500 Hours, No Voltage Applied, at 105°C

- (a) Capacitance Change : Within 20% of Initial Value
- (b) Dissipation Factor : Not Exceed 200% of Initial Requirement
- (c) Leakage Current : Not Exceed 200% of Initial Requirement

Dimensions : mm

Rubber Stand-off



L ≤ 12 L + 1.5Max.
 13 ≤ L ≤ 15 L + 1.0
 L ≥ 16 L + 2.0Max.

| D ϕ | F | d ϕ |
|----------|-----|----------|
| 4.0 | 1.5 | 0.45 |
| 5.0 | 2.0 | |
| 6.3 | 2.5 | |
| 8.0 | 3.5 | 0.5 |



CASE SIZE & PERMISSIBLE RIPPLE CURRENT OF STANDARD PRODUCTS

| CAP. (μF) | RATED VOLTAGE WV | | | | | | | | | | | |
|-----------|------------------|----------|----------------|----------|----------------|----------|------------------|----------|-------|--------|----------------|----------|
| | 6.3 | | 10 | | 16 | | 25 | | 35 | | 50 | |
| | Size | Ripple | Size | Ripple | Size | Ripple | Size | Ripple | Size | Ripple | Size | Ripple |
| 0.1 | | | | | | | | | | | 4 × 5 | 1 |
| 0.22 | | | | | | | | | | | 4 × 5 | 2 |
| 0.33 | | | | | | | | | | | 4 × 5 | 3 |
| 0.47 | | | | | | | | | | | 4 × 5 | 4 |
| 1.0 | | | | | | | | | | | 4 × 5 | 9 |
| 2.2 | | | | | | | | | | | 4 × 5 | 13 |
| 3.3 | | | | | | | 4 × 5 | 13 | | | 4 × 5 | 17 |
| 4.7 | 4 × 5 | 16 | | | 4 × 5 | 20 | 4 × 5 | 16 | 4 × 5 | 18 | 4 × 5 5 × 5 | 17 20 |
| 10 | 4 × 5 | 18 | 4 × 5 | 20 | 4 × 5 | 23 | 4 × 5 5 × 5 | 20 27 | 5 × 5 | 30 | 6 × 5 | 33 |
| 22 | 4 × 5 | 28 | 5 × 5 | 33 | 4 × 5 5 × 5 | 29 37 | 6 × 5 | 42 | 6 × 5 | 48 | 6.3 × 5 | 33 |
| 33 | 4 × 5 | 33 | 4 × 5 5 × 5 | 34 41 | 5 × 5 6 × 5 | 44 49 | 5 × 5 6 × 5 | 45 53 | | | | |
| 47 | 4 × 5 5 × 5 | 35 45 | 5 × 5 | 46 | 5 × 5 6 × 5 | 54 58 | 5 × 5 6.3 × 5 | 55 65 | | | | |
| 68 | | | 6 × 5 | 54 | | | | | | | | |
| 100 | 5 × 5 6 × 5 | 55 70 | 6 × 5 | 80 | 6 × 5 | 85 | 8 × 5 | 90 | | | | |
| 220 | 6 × 5 | 90 | 8 × 5 | 90 | | | | | | | | |
| 330 | 8 × 5 | 115 | | | | | | | | | | |
| 470 | 8 × 5 | 100 | | | | | | | | | | |

Note : * 1. D × L : mm

* 2. Size : 6 × 5 Actually is 6.3 × 5

* 3. mA rms at 105°C, 120Hz

Miniature Size Aluminum Electrolytic Capacitors

SS [For Super Miniature]

105°C Single-Ended Lead Aluminum Electrolytic Capacitors



DESCRIPTION

This type is designed to meet the demand of equipments for greatly reduced size and thickness, such as: portable micro computer, disk driver, small calculator and audio equipment.

Application : Portable Micro Computer,
Disk Driver,
Small Calculator and Audio

Multiplier for Ripple Current

Frequency coefficient

| Frequency (Hz) | 50 | 120 | 300 | 1K | 10K |
|-----------------|------|------|------|------|------|
| 0.1~47 μ F | 0.75 | 1.00 | 1.20 | 1.30 | 1.50 |
| 100~330 μ F | 0.75 | 1.00 | 1.10 | 1.15 | 1.20 |

Temperature coefficient

| Temperature(°C) | 65 | 85 | 105 |
|-----------------|------|------|------|
| Factor | 1.70 | 1.30 | 1.00 |

DIAGRAM OF DIMENSIONS



ELECTRICAL CHARACTERISTICS

Operating Temperature : -40° ~ +105°C

Working Voltage : 6.3 ~ 63V

Rate Capacitance Range : 0.1 ~ 470 μ F

Capacitance Tolerance : -20 ~ +20%

DC Leakage Current (μ A) : $I = 0.01 CV$ (μ A) or 3 μ A. Whichever is greater.

(After 2 Minutes Application of DC Working Voltage at 25°C)

Dissipation Factor : at 120 Hz, 25°C

| | | | | | | | |
|-----------|-----|----|----|----|----|----|----|
| WV (V): | 6.3 | 10 | 16 | 25 | 35 | 50 | 63 |
| D.F (%) : | 24 | 20 | 17 | 15 | 12 | 10 | 8 |

Load Life : 1000 Hours at 105°C Assured with Full Rated Maximum Ripple Current Applied

- (a) Capacitance Change : Within 20% of Initial Value
- (b) Dissipation Factor : Not Exceed 200% of Initial Requirement
- (c) Leakage Current : Not Exceed the Initial Requirement

Shelf Life : 500 Hours, No Voltage Applied, at 105°C

- (a) Capacitance Change : Within 20% of Initial Value
- (b) Dissipation Factor : Not Exceed 200% of Initial Requirement
- (c) Leakage Current : Not Exceed 200% of Initial Requirement

Dimensions : mm

Rubber Stand-off

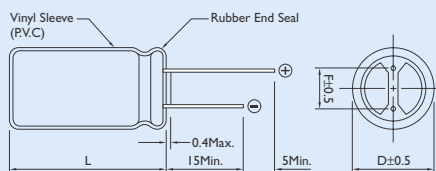

$L \leq 12$ $L + 1.5\text{Max.}$
 $13 \leq L \leq 15$ $L^{+1.0}_{-0.5}$
 $L \geq 16$ $L + 2.0\text{Max.}$

| D ϕ | F | d ϕ |
|----------|-----|----------|
| 4.0 | 1.5 | 0.45 |
| 5.0 | 2.0 | |
| 6.3 | 2.5 | |
| 8.0 | 3.5 | 0.5 |



CASE SIZE & PERMISSIBLE RIPPLE CURRENT OF STANDARD PRODUCTS

| CAP. (μF) | RATED VOLTAGE WV | | | | | | | | | | | | | | | |
|-----------|------------------|--------|-------|--------|-------|--------|-------|--------|-------|--------|-------|--------|-------|--------|--|--|
| | 6.3 | | 10 | | 16 | | 25 | | 35 | | 50 | | 63 | | | |
| | Size | Ripple | Size | Ripple | Size | Ripple | Size | Ripple | Size | Ripple | Size | Ripple | Size | Ripple | | |
| 0.1 | | | | | | | | | | | 4 x 7 | 1 | 4 x 7 | 1 | | |
| 0.22 | | | | | | | | | | | 4 x 7 | 2 | 4 x 7 | 2 | | |
| 0.33 | | | | | | | | | | | 4 x 7 | 3 | 4 x 7 | 4 | | |
| 0.47 | | | | | | | | | | | 4 x 7 | 5 | 4 x 7 | 6 | | |
| 0.68 | | | | | | | | | | | 4 x 7 | 6 | | | | |
| 1.0 | | | | | | | | | | | 4 x 7 | 10 | 4 x 7 | 13 | | |
| 2.2 | | | | | 4 x 7 | 7 | | | | | 4 x 7 | 19 | 4 x 7 | 21 | | |
| 3.3 | | | | | 4 x 7 | 13 | | | | | 4 x 7 | 24 | 4 x 7 | 26 | | |
| 4.7 | | | | | 4 x 7 | 19 | 4 x 7 | 24 | 4 x 7 | 24 | 4 x 7 | 29 | 4 x 7 | 26 | | |
| | | | | | | | | | 5 x 7 | 24 | 5 x 7 | 31 | 6 x 7 | 33 | | |
| | | | 4 x 7 | | 4 x 7 | 29 | 4 x 7 | 33 | 4 x 7 | 34 | 4 x 7 | 37 | 5 x 7 | 42 | | |
| 10 | | | | | | | 5 x 7 | 35 | 5 x 7 | 36 | 5 x 7 | 45 | 6 x 7 | 50 | | |
| | | | | | | | 6 x 7 | 35 | | | 6 x 7 | 45 | | | | |
| | 4 x 7 | 37 | 4 x 7 | 31 | 4 x 7 | 36 | 4 x 7 | 43 | 5 x 7 | 48 | 6 x 7 | 65 | | | | |
| 22 | | | 5 x 7 | 38 | 5 x 7 | 44 | 5 x 7 | 51 | 6 x 7 | 57 | | | | | | |
| | | | | | | | 6 x 7 | 53 | | | | | | | | |
| | 5 x 7 | 42 | 4 x 7 | 39 | 4 x 7 | 50 | 5 x 7 | 55 | 6 x 7 | 70 | | | | | | |
| 33 | | | 5 x 7 | 47 | 5 x 7 | 57 | 6 x 7 | 55 | | | | | | | | |
| | 4 x 7 | 46 | 4 x 7 | 50 | 5 x 7 | 75 | 5 x 7 | 67 | 6 x 7 | 81 | 8 x 7 | | | | | |
| 47 | 5 x 7 | 55 | 5 x 7 | 60 | 6 x 7 | 77 | 6 x 7 | 79 | | | | | | | | |
| | | | 6 x 7 | 60 | | | | | | | | | | | | |
| 68 | | | | | 5 x 7 | 84 | | | | | | | | | | |
| | 5 x 7 | 75 | 5 x 7 | 85 | 5 x 7 | 94 | 6 x 7 | 120 | 8 x 7 | | | | | | | |
| 100 | 6 x 7 | 90 | 6 x 7 | 100 | 6 x 7 | 110 | 8 x 7 | 120 | | | | | | | | |
| 150 | | | | | 6 x 7 | 120 | | | | | | | | | | |
| | 6 x 7 | 130 | 6 x 7 | 135 | 8 x 7 | 140 | | | | | | | | | | |
| 220 | | | | | 8 x 9 | 140 | | | | | | | | | | |
| | | | | | | | | | | | | | | | | |
| 330 | 8 x 7 | 140 | 8 x 7 | | 8 x 9 | 155 | | | | | | | | | | |
| 470 | 8 x 7 | | 8 x 9 | 165 | | | | | | | | | | | | |

Note : * 1. D x L : mm

* 2. Size : 6 x 7 Actually is 6.3 x 7

* 3. mA rms at 105°C, 120Hz

Miniature Size Aluminum Electrolytic Capacitors

SK [For General]

85°C Single-Ended Lead Aluminum Electrolytic Capacitors



DESCRIPTION

Lower-cost capacitors expressly intended for high density printed circuit board.

Very High Volumetric Efficiency

Ideally suited for general-purpose applications, decoupling, by pass, and filtering circuit in entertainment electronics.

Feature High CV Product with Moderate Cost

Multiplier for Ripple Current

Frequency coefficient

| Frequency (Hz) | 120 | 300 | 1K | 10K~100K |
|-----------------------|------|------|------|----------|
| 6.3~100V Below~68μF | 1.00 | 1.20 | 1.30 | 1.50 |
| 6.3~100V 100~680μF | 1.00 | 1.10 | 1.15 | 1.20 |
| 6.3~110V 1000~22000μF | 1.00 | 1.05 | 1.10 | 1.15 |
| 160~450V Below~220μF | 1.00 | 1.25 | 1.40 | 1.40 |
| 160~450V 220μF Above | 1.00 | 1.10 | 1.13 | 1.13 |

Temperature coefficient

| Temperature(°C) | 50 | 70 | 85 |
|-----------------|------|------|------|
| Factor | 1.30 | 1.15 | 1.00 |

DIAGRAM OF DIMENSIONS



ELECTRICAL CHARACTERISTICS

Operating Temperature : -40° ~ +85°C / -25° ~ +85°C

Working Voltage : 6.3 ~ 100V / 160 ~ 450V

Rate Capacitance Range : 0.1 ~ 22000μF / 0.47 ~ 470μF

Capacitance Tolerance : -20 ~ +20%

DC Leakage Current (μA) : 0.01 CV or 3 μA / 0.03 CV +10 Whichever is greater.
(After 2 Minutes Application of DC Working Voltage at 25°C)

Dissipation Factor : at 120Hz, 25°C

| | | | | | | | | | | |
|-----------|-----|----|----|----|----|----|----|-----|-----------|-----------|
| WV (V): | 6.3 | 10 | 16 | 25 | 35 | 50 | 63 | 100 | 160 ~ 250 | 350 ~ 450 |
| D.F (%) : | 22 | 19 | 16 | 14 | 12 | 10 | 9 | 8 | 15 | 20 |

For capacitor whose capacitance exceeds 1000μF. The value of DF(%) is increased by 2% for every addition of 1000μF.

Load Life : 2000 Hours at 85°C Assured with Full Rated Maximum Ripple Current Applied

- (a) Capacitance Change : Within 20% of Initial Value
- (b) Dissipation Factor : Not Exceed 200% of Initial Requirement
- (c) Leakage Current : Not Exceed the Initial Requirement

Shelf Life : 1000 Hours, No Voltage Applied at 85°C

- (a) Capacitance Change : Within 20% of Initial Value
- (b) Dissipation Factor : Not Exceed 200% of Initial Requirement
- (c) Leakage Current : Not Exceed 200% of Initial Requirement

Dimensions : mm

Rubber Stand-off



L ≤ 12 L + 1.5Max.
13 ≤ L ≤ 15 L +1.0 / -0.5
L ≥ 16 L + 2.0Max.

| Dø | F | dø |
|------|------|------|
| 4.0 | 1.5 | 0.45 |
| 5.0 | 2.0 | 0.5 |
| 6.0 | 2.5 | |
| 8.0 | 3.5 | |
| 10.0 | 5.0 | 0.6 |
| 12.0 | | |
| 13.0 | | |
| 16.0 | 7.5 | 0.8 |
| 18.0 | | |
| 22.0 | 10.0 | 0.8 |



CASE SIZE & PERMISSIBLE RIPPLE CURRENT OF STANDARD PRODUCTS

| CAP. (μF) | RATED VOLTAGE WV | | | | | | | | | | | | | | | |
|-----------|------------------|--------|---------|--------|---------|--------|---------|--------|---------|--------|---------|--------|---------|--------|--|--|
| | 6.3 | | 10 | | 16 | | 25 | | 35 | | 50 | | 63 | | | |
| | Size | Ripple | Size | Ripple | Size | Ripple | Size | Ripple | Size | Ripple | Size | Ripple | Size | Ripple | | |
| 0.1 | | | | | | | | | | | 5 x 11 | 1 | | | | |
| 0.22 | | | | | | | | | | | 5 x 11 | 2 | | | | |
| 0.33 | | | | | | | | | | | 5 x 11 | 3 | 5 x 11 | 3 | | |
| 0.47 | | | | | | | | | | | 5 x 11 | 5 | 5 x 11 | 5 | | |
| 0.68 | | | | | | | | | | | 5 x 11 | 7 | | | | |
| 1.0 | | | | | | | | | | | 5 x 11 | 10 | 5 x 11 | 10 | | |
| 2.2 | | | | | | | | | | | 5 x 11 | 23 | 5 x 11 | 29 | | |
| 3.3 | | | | | | | | | | | 5 x 11 | 35 | 5 x 11 | 40 | | |
| 4.7 | | | 5 x 11 | 20 | 5 x 11 | 25 | 5 x 11 | 30 | 5 x 11 | 35 | 5 x 11 | 40 | 5 x 11 | 45 | | |
| 6.8 | | | | | | | | | | | 5 x 11 | 50 | | | | |
| 10 | | | 5 x 11 | 35 | 5 x 11 | 40 | 5 x 11 | 50 | 5 x 11 | 60 | 5 x 11 | 65 | 5 x 11 | 70 | | |
| 15 | | | | | 5 x 11 | 50 | | | | | 5 x 11 | 80 | | | | |
| 22 | 5 x 11 | 35 | 5 x 11 | 55 | 5 x 11 | 75 | 5 x 11 | 90 | 5 x 11 | 95 | 5 x 11 | 100 | 5 x 11 | 95 | | |
| 33 | 5 x 11 | 55 | 5 x 11 | 80 | 5 x 11 | 110 | 5 x 11 | 115 | 5 x 11 | 120 | 5 x 11 | 105 | 6 x 11 | 115 | | |
| 47 | 5 x 11 | 75 | 5 x 11 | 95 | 5 x 11 | 130 | 5 x 11 | 135 | 5 x 11 | 120 | 6 x 11 | 140 | 8 x 11 | 130 | | |
| 68 | | | | | 5 x 11 | 150 | 5 x 11 | 135 | | | | | | | | |
| 100 | 5 x 11 | 130 | 5 x 11 | 180 | 5 x 11 | 165 | 6 x 11 | 160 | 6 x 11 | 185 | 8 x 11 | 230 | 8 x 11 | 190 | | |
| | | | | | 6 x 11 | 185 | | | 8 x 11 | 230 | 10 x 12 | 250 | 10 x 12 | 300 | | |
| 220 | 5 x 11 | 200 | 5 x 11 | 180 | 6 x 11 | 260 | 8 x 11 | 290 | 10 x 12 | 370 | 10 x 12 | 380 | 10 x 15 | 410 | | |
| | 6 x 11 | 240 | | | 8 x 11 | 320 | 10 x 12 | 340 | 10 x 15 | 370 | 10 x 15 | 440 | 10 x 19 | 490 | | |
| 330 | 6 x 11 | 260 | 6 x 11 | 265 | 6 x 11 | 290 | 8 x 11 | 315 | 10 x 12 | 420 | 10 x 15 | 490 | 10 x 19 | 540 | | |
| | 8 x 11 | 300 | 8 x 11 | 330 | 8 x 11 | 360 | | | 10 x 15 | 490 | 10 x 19 | 580 | 13 x 20 | 680 | | |
| | | | | | | | 10 x 12 | 420 | | | | | | | | |
| 470 | 6 x 11 | 330 | 6 x 11 | 320 | 8 x 11 | 400 | 8 x 15 | 420 | 10 x 15 | 430 | 10 x 19 | 610 | 13 x 20 | 755 | | |
| | 8 x 11 | 380 | 8 x 11 | 440 | 10 x 12 | 470 | 10 x 12 | 460 | 10 x 19 | 510 | 13 x 20 | 760 | 13 x 25 | 880 | | |
| | | | | | | | 10 x 15 | 540 | 13 x 12 | 640 | | | 16 x 25 | 8820 | | |
| 680 | 8 x 11 | 410 | 10 x 12 | 460 | 10 x 12 | 510 | 10 x 15 | 540 | 13 x 20 | 705 | | | 13 x 25 | 965 | | |
| | | | | | 10 x 15 | 565 | 10 x 19 | 595 | 13 x 25 | 780 | | | | | | |
| 1000 | 8 x 11 | 460 | 10 x 12 | 580 | 10 x 15 | 630 | 10 x 19 | 760 | 13 x 20 | 950 | 13 x 25 | 1100 | 16 x 25 | 1310 | | |
| | 10 x 12 | 580 | 10 x 15 | 630 | 10 x 19 | 790 | 12 x 16 | 760 | 13 x 25 | 1100 | 16 x 25 | 1350 | 16 x 32 | 1550 | | |
| | | | | | | | 13 x 20 | 950 | | | | | | | | |
| 1500 | | | 10 x 19 | 700 | | | | | 16 x 25 | 1240 | | | 18 x 36 | 2090 | | |
| 2200 | 10 x 19 | 840 | 10 x 19 | 880 | 10 x 25 | 925 | 13 x 25 | 1300 | 16 x 25 | 1600 | 16 x 36 | 1850 | 18 x 40 | 2200 | | |
| | 13 x 20 | 1050 | 13 x 20 | 1100 | 13 x 25 | 1350 | 16 x 25 | 1550 | 16 x 32 | 1800 | 18 x 36 | 2090 | 22 x 35 | 2200 | | |
| | | | | | | | 18 x 20 | 1550 | | | | | | | | |
| 3300 | 10 x 19 | 1000 | 13 x 20 | 1250 | 13 x 25 | 1400 | 16 x 25 | 1660 | 16 x 36 | 1970 | 18 x 36 | 2170 | 22 x 40 | 2500 | | |
| | | | | | 16 x 25 | 1700 | 16 x 32 | 1950 | 18 x 36 | 2220 | 18 x 40 | 2400 | | | | |
| 4700 | 13 x 20 | 1300 | 13 x 25 | 1500 | 16 x 25 | 1800 | 16 x 32 | 1950 | 18 x 36 | 2400 | 22 x 35 | 2240 | | | | |
| | | | 16 x 25 | 1800 | 16 x 32 | 2100 | 18 x 36 | 2360 | | | 22 x 40 | 2500 | | | | |
| 6800 | 16 x 25 | 1900 | 16 x 25 | 1900 | 16 x 32 | 1980 | 18 x 36 | 2550 | 22 x 40 | 2600 | | | | | | |
| | | | 16 x 32 | 2150 | 16 x 36 | 2200 | | | | | | | | | | |
| | | | | | 18 x 36 | 2500 | | | | | | | | | | |
| 10000 | 16 x 25 | 1900 | 18 x 36 | 2500 | 18 x 36 | 2700 | 22 x 40 | 2800 | | | | | | | | |
| | 16 x 32 | 2250 | | | | | | | | | | | | | | |
| 15000 | 16 x 36 | 2500 | 18 x 36 | 2950 | 22 x 40 | 3150 | 22 x 40 | 3200 | | | | | | | | |
| 22000 | 18 x 40 | 3650 | 22 x 40 | 3700 | 22 x 40 | 3800 | | | | | | | | | | |

Note : * I. D x L : mm

* 2. mA rms at 85°C, 120Hz



CASE SIZE & PERMISSIBLE RIPPLE CURRENT OF STANDARD PRODUCTS

| CAP. (μF) | RATED VOLTAGE WV | | | | | | | | | | | | | |
|-----------|------------------|--------|---------|--------|---------|--------|---------|--------|---------|--------|---------|--------|---------|--------|
| | 100 | | 160 | | 200 | | 250 | | 350 | | 400 | | 450 | |
| | Size | Ripple | Size | Ripple | Size | Ripple | Size | Ripple | Size | Ripple | Size | Ripple | Size | Ripple |
| 0.22 | 5 × 11 | 5 | | | | | | | | | | | | |
| 0.47 | 5 × 11 | 10 | 5 × 11 | 12 | 5 × 11 | 14 | 5 × 11 | 14 | 5 × 11 | 14 | 6 × 11 | 14 | 6 × 11 | 14 |
| 1.0 | 5 × 11 | 21 | 5 × 11 | 17 | 5 × 11 | 19 | 5 × 11 | 17 | 6 × 11 | 19 | 6 × 11 | 16 | 8 × 11 | 19 |
| | | | 6 × 11 | 17 | | | 6 × 11 | 19 | | | 8 × 11 | 19 | | |
| 2.2 | 5 × 11 | 30 | 6 × 11 | 26 | 6 × 11 | 22 | 6 × 11 | 24 | 8 × 11 | 33 | 8 × 11 | 26 | 10 × 12 | 33 |
| | | | 8 × 11 | 27 | 8 × 11 | 27 | 8 × 11 | 30 | 10 × 10 | 33 | 10 × 12 | 33 | | |
| 3.3 | 5 × 11 | 45 | 6 × 11 | 30 | 6 × 11 | 30 | 8 × 11 | 30 | 8 × 11 | 33 | 10 × 12 | 40 | 10 × 15 | 42 |
| | | | 8 × 11 | 35 | 8 × 11 | 37 | 10 × 12 | 38 | 10 × 12 | 39 | | | | |
| 4.7 | 5 × 11 | 50 | 6 × 11 | 32 | 8 × 11 | 36 | 8 × 11 | 36 | 10 × 12 | 39 | 8 × 15 | 33 | 10 × 15 | 50 |
| | | | 8 × 11 | 40 | 10 × 12 | 45 | 10 × 12 | 45 | 10 × 15 | 45 | 10 × 15 | 45 | 10 × 19 | 50 |
| 6.8 | 5 × 11 | 55 | | | | | 8 × 11 | 40 | | | | | 10 × 15 | 50 |
| | | | | | | | 10 × 12 | 50 | | | | | 10 × 19 | 56 |
| 10 | 5 × 11 | 65 | 8 × 11 | 50 | 10 × 12 | 57 | 10 × 15 | 70 | 10 × 15 | 70 | 10 × 15 | 50 | 10 × 19 | 56 |
| | 6 × 11 | 75 | 10 × 12 | 65 | 10 × 15 | 70 | 10 × 19 | 70 | 10 × 19 | 70 | 10 × 19 | 56 | 13 × 20 | 60 |
| | | | 10 × 15 | 65 | | | | | 13 × 20 | 70 | 13 × 20 | 70 | 13 × 25 | 75 |
| 15 | 8 × 11 | 93 | | | | | 10 × 19 | 75 | 10 × 19 | 90 | | | | |
| | | | | | | | 13 × 20 | 90 | | | | | | |
| 22 | 6 × 11 | 105 | 10 × 15 | 110 | 10 × 15 | 120 | 10 × 19 | 130 | 13 × 20 | 130 | 13 × 20 | 100 | 16 × 20 | 100 |
| | 8 × 11 | 130 | 10 × 19 | 110 | | | | | | | 13 × 25 | 110 | 16 × 25 | 110 |
| | | | | | | | | | | | 16 × 25 | 130 | 16 × 32 | 130 |
| 33 | 8 × 11 | 140 | 10 × 19 | 150 | 10 × 19 | 150 | 13 × 20 | 140 | 13 × 25 | 170 | 13 × 25 | 140 | 16 × 25 | 145 |
| | 10 × 12 | 170 | | | | | 13 × 25 | 160 | 16 × 25 | 170 | 16 × 20 | 145 | 16 × 32 | 160 |
| | | | | | | | | | | | 16 × 25 | 170 | 16 × 36 | 180 |
| | | | | | | | | | | | | | | |
| 47 | 10 × 12 | 190 | 12 × 16 | 145 | 13 × 20 | 160 | 13 × 25 | 210 | 16 × 25 | 220 | 16 × 25 | 180 | 18 × 36 | 200 |
| | 10 × 15 | 230 | 12 × 25 | 180 | 13 × 25 | 190 | 16 × 25 | 210 | | | 16 × 32 | 220 | 18 × 40 | 230 |
| | | | 13 × 20 | 180 | | | | | | | 16 × 36 | 220 | | |
| 68 | 10 × 15 | 280 | | | 13 × 25 | 230 | 16 × 25 | 210 | | | 16 × 32 | 220 | 18 × 32 | 265 |
| 100 | 10 × 19 | 400 | 13 × 25 | 250 | 16 × 25 | 330 | 16 × 32 | 310 | 16 × 36 | 320 | 18 × 36 | 360 | 22 × 40 | 370 |
| | | | 16 × 25 | 300 | | | | | 18 × 36 | 360 | 18 × 32 | 360 | | |
| 150 | 13 × 20 | 500 | | | | | 18 × 40 | 410 | | | 18 × 40 | 410 | | |
| 220 | 13 × 25 | 710 | 16 × 32 | 450 | 18 × 25 | 485 | 18 × 36 | 540 | | | | | | |
| | | | 16 × 36 | 510 | 18 × 32 | 540 | 18 × 40 | 600 | | | | | | |
| | | | | | 18 × 36 | 600 | | | | | | | | |
| 330 | 13 × 25 | 720 | 18 × 36 | 540 | 16 × 40 | 710 | 18 × 40 | 600 | | | | | | |
| | 16 × 25 | 860 | 18 × 40 | 600 | 16 × 45 | 750 | | | | | | | | |
| | | | | | 18 × 32 | 685 | | | | | | | | |
| | | | | | 18 × 36 | 725 | | | | | | | | |
| | | | | | 18 × 40 | 800 | | | | | | | | |
| 470 | 13 × 40 | 1100 | 22 × 40 | 900 | 18 × 40 | 750 | | | | | | | | |
| | 16 × 25 | 1100 | | | 22 × 35 | 1000 | | | | | | | | |
| | 16 × 32 | 1100 | | | | | | | | | | | | |
| 680 | 16 × 36 | 1260 | | | | | | | | | | | | |
| 1000 | 18 × 40 | 1350 | | | | | | | | | | | | |
| | 22 × 35 | 1680 | | | | | | | | | | | | |
| 2200 | 22 × 40 | 2300 | | | | | | | | | | | | |

Note : * I. D × L : mm

* 2. mA rms at 85°C, 120Hz

SE-K [For General]

105°C Single-Ended Lead Aluminum Electrolytic Capacitors Rated Voltage up to 450V

Miniature Size Aluminum Electrolytic Capacitors

ELECTRICAL CHARACTERISTICS

Operating Temperature : -40° ~ +105°C / -25° ~ +105°C

Working Voltage : 6.3 ~ 250V / 350 ~ 450V

Rate Capacitance Range : 0.47 ~ 15000µF / 0.47 ~ 150µF

Capacitance Tolerance : -20 ~ +20%

DC Leakage Current (µA) : I = 0.01CV + 3 / 0.03CV + 10
(After 2 Minutes Application of DC Working Voltage at 25°C)

Dissipation Factor : at 120 Hz, 25°C

| | | | | | | | | | | | |
|-----------|-----|----|----|----|----|----|----|----|-----|-----------|-----------|
| WV (V): | 6.3 | 10 | 16 | 25 | 35 | 50 | 63 | 80 | 100 | 160 ~ 250 | 350 ~ 450 |
| D.F (%) : | 26 | 22 | 18 | 16 | 14 | 12 | 10 | 10 | 10 | 15 | 20 |

For capacitor whose capacitance exceeds 1000 µF. The value of DF(%) is increased by 2% for every addition of 1000 µF.

Load Life : 1000 Hours at Assured with Full Rated Maximum Ripple Current Applied

- (a) Capacitance Change : Within 20% of Initial Value
- (b) Dissipation Factor : Not Exceed 200% of Initial Requirement
- (c) Leakage Current : Not Exceed the Initial Requirement

Shelf Life : 500 Hours, No Voltage Applied

- (a) Capacitance Change : Within 20% of Initial Value
- (b) Dissipation Factor : Not Exceed 200% of Initial Requirement
- (c) Leakage Current : Not Exceed 200% of Initial Requirement

DIAGRAM OF DIMENSIONS

| Dø | F | dø |
|------|------|------|
| 4.0 | 1.5 | 0.45 |
| 5.0 | 2.0 | 0.5 |
| 6.0 | 2.5 | |
| 8.0 | 3.5 | |
| 10.0 | 5.0 | 0.6 |
| 12.0 | | |
| 13.0 | | |
| 16.0 | 7.5 | 0.8 |
| 18.0 | | |
| 22.0 | 10.0 | 0.8 |

Rubber Stand-off



L ≤ 12 L + 1.5Max.
 13 ≤ L ≤ 15 L +1.0 / L -0.5
 L ≥ 16 L + 2.0Max.

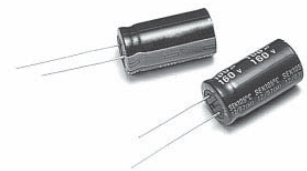

DESCRIPTION

Lower-cost capacitors expressly intended for high density printed circuit board.

Very High Volumetric Efficiency

Ideally suited for general-purpose applications, coupling, decoupling, by pass, and filtering circuit in entertainment electronics.

Feature High CV Product with Moderate Cost

Multiplier for Ripple Current

Frequency coefficient

| Frequency (Hz) | 120 | 300 | 1K | 10K~100K |
|-----------------------|------|------|------|----------|
| 6.3~100V Below~68µF | 1.00 | 1.20 | 1.30 | 1.45 |
| 6.3~100V 100~680µF | 1.00 | 1.10 | 1.15 | 1.25 |
| 6.3~110V 1000~22000µF | 1.00 | 1.05 | 1.10 | 1.15 |
| 160~450V ALL Cap(µF) | 1.00 | 1.05 | 1.10 | 1.50 |

Temperature coefficient

| Temperature(°C) | 65 | 85 | 105 |
|-----------------|------|------|------|
| Factor | 1.80 | 1.40 | 1.00 |

Dimensions : mm





CASE SIZE & PERMISSIBLE RIPPLE CURRENT OF STANDARD PRODUCTS

| CAP. (μF) | RATED VOLTAGE WV | | | | | | | | | | | | | | | |
|-----------|------------------|--------|---------|--------|---------|--------|---------|--------|---------|--------|---------|--------|---------|--------|--|--|
| | 6.3 | | 10 | | 16 | | 25 | | 35 | | 50 | | 63 | | | |
| | Size | Ripple | Size | Ripple | Size | Ripple | Size | Ripple | Size | Ripple | Size | Ripple | Size | Ripple | | |
| 0.47 | | | | | | | | | | | 5 × 11 | 7 | 5 × 11 | 8 | | |
| 1.0 | | | | | | | | | | | 5 × 11 | 12 | 5 × 11 | 13 | | |
| 2.2 | | | | | | | | | | | 5 × 11 | 18 | 5 × 11 | 20 | | |
| 3.3 | | | | | | | | | | | 5 × 11 | 25 | 5 × 11 | 27 | | |
| 4.7 | | | | | | | 5 × 11 | 20 | 5 × 11 | 25 | 5 × 11 | 30 | 5 × 11 | 34 | | |
| 6.8 | | | | | | | 5 × 11 | 25 | 5 × 11 | 30 | 5 × 11 | 32 | 5 × 11 | 37 | | |
| 10 | | | | | 5 × 11 | 25 | 5 × 11 | 30 | 5 × 11 | 40 | 5 × 11 | 50 | 5 × 11 | 55 | | |
| 15 | | | | | 5 × 11 | 40 | 5 × 11 | 45 | 5 × 11 | 50 | 5 × 11 | 60 | 5 × 11 | 65 | | |
| 22 | | | 5 × 11 | 45 | 5 × 11 | 55 | 5 × 11 | 60 | 5 × 11 | 65 | 5 × 11 | 75 | 6 × 11 | 90 | | |
| 33 | | | 5 × 11 | 60 | 5 × 11 | 70 | 5 × 11 | 75 | 5 × 11 | 85 | 6 × 11 | 105 | 6 × 11 | 110 | | |
| | | | | | | | | | | | | | 8 × 11 | 120 | | |
| 47 | 5 × 11 | 60 | 5 × 11 | 75 | 5 × 11 | 85 | 5 × 11 | 90 | 5 × 11 | 95 | 6 × 11 | 100 | 8 × 11 | 155 | | |
| | | | | | | | | | 6 × 11 | 115 | 8 × 11 | 125 | | | | |
| 68 | 5 × 11 | 75 | 5 × 11 | 80 | 5 × 11 | 100 | 6 × 11 | 125 | 8 × 11 | 130 | 8 × 11 | 159 | 10 × 12 | 198 | | |
| 100 | 5 × 11 | 100 | 5 × 11 | 110 | 5 × 11 | 110 | 6 × 11 | 145 | 6 × 11 | 150 | 8 × 11 | 160 | 8 × 15 | 230 | | |
| | | | | | | | 6 × 11 | 135 | 8 × 11 | 190 | 10 × 12 | 210 | 10 × 12 | 260 | | |
| 150 | 5 × 11 | 120 | 5 × 11 | 110 | 8 × 11 | 180 | 8 × 11 | 200 | 10 × 12 | 240 | 10 × 12 | 289 | 10 × 15 | 330 | | |
| | | | 6 × 11 | 130 | | | | | | | | | | | | |
| 220 | 5 × 11 | 140 | 6 × 11 | 180 | 6 × 11 | 180 | 8 × 11 | 200 | 8 × 11 | 230 | 10 × 12 | 340 | 10 × 15 | 400 | | |
| | 6 × 11 | 165 | | | 8 × 11 | 235 | 10 × 12 | 250 | 8 × 15 | 280 | 10 × 15 | 400 | 10 × 19 | 460 | | |
| | | | | | | | | | 10 × 12 | 315 | | | | | | |
| 330 | 6 × 11 | 160 | 6 × 11 | 205 | 8 × 11 | 285 | 8 × 11 | 265 | 8 × 15 | 345 | 10 × 15 | 450 | 10 × 19 | 520 | | |
| | 8 × 11 | 200 | 8 × 11 | 255 | | | 8 × 15 | 320 | 8 × 20 | 420 | 10 × 19 | 535 | 13 × 20 | 650 | | |
| | | | | | | | 10 × 12 | 355 | 10 × 12 | 380 | | | | | | |
| | | | | | | | | | 10 × 15 | 440 | | | | | | |
| 470 | 6 × 11 | 220 | 6 × 11 | 245 | 8 × 11 | 310 | 8 × 15 | 365 | 10 × 15 | 415 | 10 × 19 | 580 | 13 × 20 | 700 | | |
| | 8 × 11 | 280 | 8 × 11 | 305 | 8 × 15 | 360 | 10 × 12 | 400 | 10 × 19 | 490 | 13 × 20 | 730 | 13 × 25 | 800 | | |
| | | | | | 10 × 12 | 395 | 10 × 15 | 470 | 13 × 20 | 580 | | | | | | |
| 680 | 8 × 11 | 255 | 8 × 11 | 335 | 10 × 12 | 455 | 10 × 19 | 650 | 13 × 20 | 730 | 13 × 25 | 860 | 13 × 25 | 840 | | |
| | 10 × 12 | 320 | 8 × 15 | 385 | 10 × 15 | 530 | | | | | | | 16 × 25 | 1000 | | |
| | | | 10 × 12 | 420 | | | | | | | | | | | | |
| 1000 | 8 × 11 | 370 | 8 × 11 | 390 | 8 × 20 | 600 | 10 × 19 | 680 | 13 × 20 | 850 | 13 × 25 | 930 | 16 × 25 | 1020 | | |
| | 10 × 12 | 470 | 8 × 15 | 450 | 10 × 15 | 590 | 12 × 20 | 775 | 13 × 25 | 995 | 16 × 25 | 1110 | 16 × 32 | 1200 | | |
| | | | 10 × 12 | 490 | 10 × 19 | 700 | 13 × 20 | 855 | | | | | | | | |
| | | | 10 × 15 | 570 | | | | | | | | | | | | |
| 1500 | 10 × 15 | 600 | 10 × 19 | 750 | 10 × 19 | 680 | 13 × 25 | 1020 | 13 × 25 | 935 | 16 × 32 | 1350 | 16 × 32 | 1300 | | |
| | | | | | 13 × 20 | 860 | | | 16 × 25 | 1110 | | | 16 × 36 | 1450 | | |
| 2200 | 10 × 19 | 740 | 10 × 19 | 800 | 10 × 25 | 895 | 13 × 25 | 1030 | 16 × 25 | 1230 | 16 × 36 | 1360 | 18 × 36 | 1455 | | |
| | 13 × 20 | 930 | 13 × 20 | 1010 | 12 × 25 | 1040 | 16 × 25 | 1230 | 16 × 32 | 1450 | 18 × 36 | 1530 | | | | |
| | | | | | 13 × 20 | 990 | | | | | | | | | | |
| | | | | | 13 × 25 | 1150 | | | | | | | | | | |
| 3300 | 10 × 19 | 880 | 10 × 25 | 950 | 13 × 25 | 1140 | 13 × 25 | 1035 | 16 × 36 | 1470 | 18 × 36 | 1540 | | | | |
| | 13 × 20 | 1100 | 10 × 30 | 1090 | 16 × 25 | 1350 | 16 × 25 | 1230 | 18 × 36 | 1660 | 18 × 40 | 1700 | | | | |
| | | | 13 × 20 | 1050 | | | 16 × 32 | 1450 | | | | | | | | |
| | | | 13 × 25 | 1220 | | | | | | | | | | | | |
| 4700 | 13 × 25 | 1100 | 13 × 25 | 1190 | 16 × 25 | 1330 | 16 × 32 | 1420 | 18 × 36 | 1580 | 22 × 35 | 1900 | | | | |
| | 16 × 25 | 1320 | 16 × 25 | 1410 | 16 × 32 | 1560 | 18 × 36 | 1690 | 18 × 40 | 1750 | | | | | | |
| 6800 | 13 × 25 | 1250 | 16 × 25 | 1370 | 16 × 36 | 1590 | 18 × 36 | 1850 | 22 × 40 | 1885 | | | | | | |
| | 16 × 25 | 1490 | 16 × 32 | 1610 | 16 × 40 | 1670 | | | | | | | | | | |
| | | | | | 18 × 36 | 1790 | | | | | | | | | | |
| 10000 | 16 × 25 | 1560 | 16 × 36 | 1760 | 18 × 36 | 2100 | | | | | | | | | | |
| | 16 × 32 | 1830 | 18 × 36 | 1980 | | | | | | | | | | | | |
| 15000 | 18 × 36 | 2280 | 18 × 40 | 1960 | | | | | | | | | | | | |

Note : * I. D × L : mm

* 2. mA rms at 85°C, 120Hz



CASE SIZE & PERMISSIBLE RIPPLE CURRENT OF STANDARD PRODUCTS

| CAP. (μF) | RATED VOLTAGE WV | | | | | | | | | | | | | |
|-----------|------------------|--------|---------|--------|---------|--------|---------|--------|---------|--------|---------|--------|---------|--------|
| | 100 | | 160 | | 200 | | 250 | | 350 | | 400 | | 450 | |
| | Size | Ripple | Size | Ripple | Size | Ripple | Size | Ripple | Size | Ripple | Size | Ripple | Size | Ripple |
| 0.47 | 5 × 11 | 10 | 5 × 11 | 12 | 5 × 11 | 14 | 5 × 11 | 14 | 5 × 11 | 14 | 6 × 11 | 14 | 6 × 11 | 14 |
| 1.0 | 5 × 11 | 15 | 5 × 11 | 17 | 5 × 11 | 19 | 6 × 11 | 19 | 6 × 11 | 20 | 6 × 11 | 16 | 8 × 11 | 20 |
| | | | | | | | | | | | 8 × 11 | 20 | | |
| 2.2 | 5 × 11 | 22 | 6 × 11 | 25 | 6 × 11 | 22 | 6 × 11 | 23 | 8 × 11 | 35 | 8 × 11 | 28 | 10 × 12 | 35 |
| | | | | | | 8 × 11 | 28 | 8 × 11 | 29 | | 10 × 12 | 35 | | |
| 3.3 | 5 × 11 | 29 | 6 × 11 | 30 | 6 × 11 | 32 | 8 × 11 | 33 | 8 × 11 | 37 | 8 × 11 | 38 | 10 × 15 | 54 |
| | | | 8 × 11 | 36 | 8 × 11 | 40 | 10 × 12 | 42 | 10 × 12 | 47 | 10 × 12 | 50 | | |
| 4.7 | 5 × 11 | 37 | 6 × 11 | 34 | 8 × 11 | 40 | 8 × 11 | 41 | 10 × 12 | 47 | 8 × 15 | 45 | 10 × 15 | 60 |
| | | | 8 × 11 | 43 | 10 × 12 | 50 | 10 × 12 | 52 | 10 × 15 | 55 | 10 × 12 | 49 | | |
| | | | | | | | | | | | 10 × 15 | 57 | | |
| 6.8 | 5 × 11 | 46 | 10 × 12 | 54 | 10 × 12 | 60 | 8 × 15 | 57 | 10 × 15 | 65 | 10 × 15 | 60 | 10 × 19 | 80 |
| | | | | | | | 10 × 12 | 62 | | | 10 × 19 | 72 | | |
| 10 | 5 × 11 | 55 | 8 × 11 | 56 | 10 × 12 | 69 | 10 × 15 | 88 | 10 × 15 | 95 | 10 × 15 | 65 | 13 × 20 | 85 |
| | 6 × 11 | 65 | 10 × 12 | 70 | 10 × 15 | 80 | | | | | 10 × 19 | 77 | 13 × 25 | 100 |
| | | | | | | | | | | | 13 × 20 | 97 | | |
| 15 | 8 × 11 | 82 | 10 × 15 | 90 | 10 × 15 | 110 | 10 × 15 | 120 | 10 × 19 | 140 | 10 × 19 | 100 | 16 × 25 | 160 |
| | | | | | | | | | | | 13 × 20 | 125 | | |
| | | | | | | | | | | | 13 × 25 | 150 | | |
| 22 | 8 × 11 | 115 | 8 × 20 | 125 | 10 × 15 | 140 | 10 × 19 | 155 | 13 × 20 | 165 | 13 × 20 | 150 | 13 × 25 | 125 |
| | | | 10 × 15 | 130 | | | | | | | 13 × 25 | 175 | 16 × 25 | 150 |
| | | | | | | | | | | | | | 16 × 32 | 180 |
| 33 | 8 × 11 | 120 | 10 × 19 | 180 | 10 × 19 | 190 | 13 × 20 | 170 | 13 × 25 | 220 | 13 × 25 | 190 | 16 × 25 | 190 |
| | 10 × 12 | 160 | | | | | 13 × 25 | 200 | | | 16 × 20 | 195 | 16 × 36 | 240 |
| | | | | | | | | | | | 16 × 25 | 230 | | |
| 47 | 10 × 12 | 180 | 13 × 20 | 270 | 13 × 20 | 240 | 13 × 25 | 330 | 16 × 25 | 340 | 16 × 25 | 280 | 16 × 36 | 300 |
| | 10 × 15 | 210 | | | 13 × 25 | 290 | | | | | 16 × 32 | 315 | 18 × 40 | 360 |
| | | | | | | | | | | | 16 × 36 | 350 | | |
| | | | | | | | | | | | 18 × 20 | 275 | | |
| | | | | | | | | | | | 18 × 25 | 300 | | |
| 68 | 10 × 15 | 241 | 13 × 25 | 300 | 13 × 25 | 330 | 16 × 25 | 350 | 16 × 32 | 370 | 16 × 32 | 320 | 18 × 32 | 305 |
| | | | | | | | | | | | 16 × 36 | 335 | 22 × 40 | 400 |
| | | | | | | | | | | | 18 × 25 | 305 | | |
| | | | | | | | | | | | 18 × 36 | 380 | | |
| 100 | 10 × 19 | 385 | 13 × 25 | 330 | 13 × 25 | 340 | 16 × 32 | 430 | 18 × 36 | 460 | 16 × 36 | 425 | | |
| | | | 16 × 25 | 400 | 16 × 25 | 410 | | | | | 18 × 32 | 430 | | |
| | | | | | | | | | | | 18 × 36 | 480 | | |
| 120 | | | | | | | | | | | 18 × 36 | 480 | | |
| 150 | 13 × 25 | 414 | 16 × 32 | 435 | 16 × 36 | 450 | 18 × 40 | 460 | 22 × 40 | 480 | 22 × 40 | 450 | | |
| 220 | 13 × 25 | 590 | 16 × 32 | 550 | 18 × 32 | 520 | 22 × 40 | 680 | | | | | | |
| | | | 16 × 36 | 620 | 18 × 36 | 580 | | | | | | | | |
| | | | | | 18 × 40 | 650 | | | | | | | | |
| 330 | 13 × 25 | 600 | 18 × 36 | 770 | 18 × 36 | 705 | | | | | | | | |
| | 16 × 25 | 720 | 18 × 40 | 850 | 18 × 40 | 780 | | | | | | | | |
| | | | | | 22 × 40 | 920 | | | | | | | | |
| 470 | 16 × 25 | 740 | 22 × 40 | 980 | | | | | | | | | | |
| | 16 × 32 | 875 | | | | | | | | | | | | |
| 680 | 16 × 36 | 1200 | | | | | | | | | | | | |
| 1000 | 18 × 40 | 1340 | | | | | | | | | | | | |
| | 22 × 40 | 1500 | | | | | | | | | | | | |

Note : * I. D × L : mm

* 2. mA rms at 105°C, 120Hz

Miniature Size Aluminum Electrolytic Capacitors

SH [For General]

105°C Single-Ended Lead Aluminum Electrolytic Capacitors
for the Rated Voltage up to 450V



DESCRIPTION

Long life for 2,000 hours at 105°C, ideally suited for high quality and high reliability applications.

Feature High CV Product

Multiplier for Ripple Current

Frequency coefficient

| Frequency (Hz) | 120 | 300 | 1K | 10K~100K |
|----------------------|------|------|------|----------|
| 6.3~100V Below~68μF | 1.00 | 1.30 | 1.57 | 2.00 |
| 6.3~100V 100~470μF | 1.00 | 1.23 | 1.34 | 1.50 |
| 6.3~100V 471~22000μF | 1.00 | 1.10 | 1.13 | 1.15 |
| 160~450V ALL Cap(μF) | 1.00 | 1.25 | 1.40 | 1.60 |

Temperature coefficient

| Temperature(°C) | 65 | 85 | 105 |
|-----------------|------|------|------|
| Factor | 1.70 | 1.40 | 1.00 |

DIAGRAM OF DIMENSIONS



ELECTRICAL CHARACTERISTICS

Operating Temperature : -40° ~ +105°C / -25° ~ +105°C

Working Voltage : 6.3 ~ 100V / 160 ~ 450V

Rate Capacitance Range : 0.47 ~ 15000μF / 0.47 ~ 470μF

Capacitance Tolerance : -20 ~ +20%

DC Leakage Current (μA) : 0.01CV + 3 / 0.03CV + 10

(After 2 Minutes Application of DC Working Voltage at 25°C)

Dissipation Factor : at 120 Hz, 25°C

| WV (V) : | 6.3 | 10 | 16 | 25 | 35 | 50 | 63 ~ 100 | 160 ~ 250 | 350 ~ 450 |
|-----------|-----|----|----|----|----|----|----------|-----------|-----------|
| D.F (%) : | 26 | 22 | 18 | 16 | 14 | 12 | 10 | 15 | 20 |

For capacitor whose capacitance exceeds 1000μF. The value of DF(%) is increased by 2% for every addition of 1000μF.

| WV (V) : | 6.3 | 10 | 16 | 25 | 35 ~ 100 | 160 ~ 250 | 350 ~ 450 |
|---------------------------------|-----|----|----|----|----------|-----------|-----------|
| Impedance : Z - 25°C / Z + 25°C | 4 | 3 | 2 | 2 | 2 | 4 | 4 |
| Z - 40°C / Z + 20°C | 8 | 6 | 4 | 3 | 3 | 6 | 8 |

Load Life : 2000 Hours at 105°C Assured with Full Rated Maximum Ripple Current Applied

(a) Capacitance Change : Within 20% of Initial Value

(b) Dissipation Factor : Not Exceed 200% of Initial Requirement

(c) Leakage Current : Not Exceed the Initial Requirement

Shelf Life : 1000 Hours, No Voltage Applied

(a) Capacitance Change : Within 20% of Initial Value

(b) Dissipation Factor : Not Exceed 200% of Initial Requirement

(c) Leakage Current : Not Exceed 200% of Initial Requirement

Rubber Stand-off

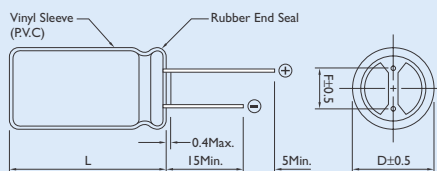

L ≤ 12 L + 1.5Max.
13 ≤ L ≤ 15 L + 1.0
L ≥ 16 L + 2.0Max.

Dimensions : mm

| Dø | F | dø |
|------|------|------|
| 4.0 | 1.5 | 0.45 |
| 5.0 | 2.0 | 0.5 |
| 6.0 | 2.5 | |
| 8.0 | 3.5 | |
| 10.0 | 5.0 | 0.6 |
| 12.0 | | |
| 13.0 | | |
| 16.0 | 7.5 | 0.8 |
| 18.0 | | |
| 22.0 | 10.0 | 0.8 |



CASE SIZE & PERMISSIBLE RIPPLE CURRENT OF STANDARD PRODUCTS

| CAP. (μF) | RATED VOLTAGE WV | | | | | | | | | | | | | | | |
|-----------|------------------|--------|---------|--------|---------|--------|---------|--------|---------|--------|---------|--------|---------|--------|--|--|
| | 6.3 | | 10 | | 16 | | 25 | | 35 | | 50 | | 63 | | | |
| | Size | Ripple | Size | Ripple | Size | Ripple | Size | Ripple | Size | Ripple | Size | Ripple | Size | Ripple | | |
| 0.47 | | | | | | | | | | | 5 × 11 | 7 | 5 × 11 | 8 | | |
| 1.0 | | | | | | | | | | | 5 × 11 | 12 | 5 × 11 | 12 | | |
| 2.2 | | | | | | | | | | | 5 × 11 | 18 | 5 × 11 | 20 | | |
| 3.3 | | | | | | | | | | | 5 × 11 | 25 | 5 × 11 | 27 | | |
| 4.7 | | | | | | | | | | | 5 × 11 | 30 | 5 × 11 | 34 | | |
| 6.8 | | | | | | | | | | | 5 × 11 | 30 | 5 × 11 | 37 | | |
| 10 | | | | | | | | | 5 × 11 | 44 | 5 × 11 | 50 | 5 × 11 | 55 | | |
| 15 | | | | | | | | | 5 × 11 | 50 | 5 × 11 | 50 | 5 × 11 | 65 | | |
| 22 | | | | | | | 5 × 11 | 60 | 5 × 11 | 65 | 5 × 11 | 75 | 6 × 11 | 90 | | |
| 33 | | | | | 5 × 11 | 70 | 5 × 11 | 75 | 5 × 11 | 85 | 6 × 11 | 105 | 8 × 11 | 110 | | |
| 47 | | | 5 × 11 | 75 | 5 × 11 | 85 | 5 × 11 | 90 | 6 × 11 | 115 | 8 × 11 | 125 | 8 × 11 | 155 | | |
| 68 | | | 5 × 11 | 80 | 5 × 11 | 100 | 6 × 11 | 125 | 8 × 11 | 130 | 8 × 11 | 159 | 10 × 12 | 198 | | |
| 100 | 5 × 11 | 100 | 5 × 11 | 110 | 6 × 11 | 135 | 6 × 11 | 145 | 8 × 11 | 190 | 10 × 12 | 210 | 10 × 12 | 260 | | |
| 150 | 5 × 11 | 120 | 6 × 11 | 130 | 8 × 11 | 180 | 8 × 11 | 200 | 10 × 12 | 240 | 10 × 12 | 289 | 10 × 15 | 330 | | |
| 220 | 6 × 11 | 165 | 6 × 11 | 180 | 6 × 11 | 180 | 10 × 12 | 250 | 10 × 12 | 315 | 10 × 15 | 400 | 10 × 19 | 465 | | |
| | | | | | 8 × 11 | 235 | | | | | | | | | | |
| 330 | 8 × 11 | 200 | 8 × 11 | 255 | 10 × 12 | 285 | 10 × 12 | 355 | 10 × 15 | 440 | 10 × 19 | 535 | 13 × 20 | 650 | | |
| 470 | 8 × 11 | 280 | 8 × 11 | 305 | 8 × 11 | 315 | 10 × 15 | 470 | 10 × 19 | 460 | 13 × 20 | 730 | 13 × 25 | 800 | | |
| | | | | | 10 × 12 | 395 | | | 13 × 20 | 580 | | | | | | |
| 680 | 10 × 12 | 320 | 10 × 12 | 420 | 10 × 15 | 530 | 10 × 19 | 650 | 13 × 20 | 730 | 13 × 25 | 860 | 16 × 25 | 1000 | | |
| 1000 | 10 × 12 | 470 | 10 × 12 | 490 | 10 × 19 | 700 | 13 × 20 | 855 | 13 × 25 | 995 | 16 × 25 | 1110 | 16 × 32 | 1200 | | |
| | | | 10 × 15 | 570 | | | | | | | | | | | | |
| 1500 | 10 × 15 | 600 | 10 × 19 | 750 | 13 × 20 | 860 | 13 × 25 | 1020 | 16 × 25 | 1110 | 16 × 32 | 1350 | 18 × 40 | 1450 | | |
| 2200 | 13 × 20 | 930 | 10 × 19 | 800 | 13 × 25 | 1150 | 16 × 25 | 1230 | 16 × 32 | 1450 | 18 × 36 | 1530 | | | | |
| | | | 13 × 20 | 1010 | | | | | | | | | | | | |
| 3300 | 13 × 20 | 1100 | 13 × 25 | 1220 | 16 × 25 | 1350 | 16 × 32 | 1450 | 18 × 36 | 1660 | | | | | | |
| 4700 | 16 × 25 | 1320 | 16 × 25 | 1410 | 16 × 25 | 1330 | 18 × 36 | 1690 | | | | | | | | |
| | | | | | 16 × 32 | 1560 | | | | | | | | | | |
| 6800 | 16 × 25 | 1490 | 16 × 32 | 1610 | 18 × 36 | 1790 | | | | | | | | | | |
| 10000 | 16 × 32 | 1830 | 18 × 36 | 1980 | | | | | | | | | | | | |
| 15000 | 18 × 36 | 2280 | | | | | | | | | | | | | | |

Note : * 1. D × L : mm

* 2. mA rms at 105°C, 120Hz



CASE SIZE & PERMISSIBLE RIPPLE CURRENT OF STANDARD PRODUCTS

| CAP. (μF) | RATED VOLTAGE WV | | | | | | | | | | | | | |
|-----------|------------------|--------|---------|--------|---------|--------|---------|--------|---------|--------|---------|--------|---------|--------|
| | 100 | | 160 | | 200 | | 250 | | 350 | | 400 | | 450 | |
| | Size | Ripple | Size | Ripple | Size | Ripple | Size | Ripple | Size | Ripple | Size | Ripple | Size | Ripple |
| 0.47 | 5 × 11 | 10 | 5 × 11 | 12 | 5 × 11 | 12 | 5 × 11 | 12 | 6 × 11 | 14 | 6 × 11 | 14 | 6 × 11 | 16 |
| 1.0 | 5 × 11 | 15 | 5 × 11 | 17 | 6 × 11 | 17 | 6 × 11 | 17 | 8 × 11 | 20 | 8 × 11 | 20 | 8 × 11 | 22 |
| 2.2 | 5 × 11 | 22 | 6 × 11 | 25 | 6 × 11 | 25 | 8 × 11 | 29 | 10 × 12 | 35 | 10 × 12 | 35 | 10 × 12 | 37 |
| 3.3 | 5 × 11 | 29 | 8 × 11 | 36 | 8 × 11 | 36 | 10 × 12 | 42 | 10 × 15 | 47 | 10 × 12 | 42 | 10 × 15 | 51 |
| | | | | | | | | | | | 10 × 15 | 49 | | |
| 4.7 | 5 × 11 | 37 | 8 × 11 | 43 | 10 × 12 | 50 | 10 × 12 | 52 | 10 × 15 | 55 | 10 × 15 | 57 | 10 × 15 | 59 |
| 6.8 | 5 × 11 | 46 | 10 × 12 | 54 | 10 × 12 | 60 | 10 × 12 | 62 | 10 × 19 | 65 | 10 × 15 | 67 | 13 × 20 | 69 |
| 10 | 6 × 11 | 65 | 10 × 12 | 70 | 10 × 15 | 80 | 10 × 15 | 75 | 13 × 20 | 95 | 10 × 19 | 75 | 13 × 25 | 99 |
| | | | | | | | 10 × 19 | 88 | | | 13 × 20 | 97 | | |
| 15 | 8 × 11 | 82 | 10 × 15 | 90 | 10 × 19 | 110 | 13 × 20 | 120 | 13 × 20 | 140 | 13 × 25 | 145 | 16 × 25 | 150 |
| 22 | 8 × 11 | 115 | 10 × 15 | 130 | 10 × 15 | 140 | 13 × 20 | 130 | 16 × 25 | 165 | 13 × 20 | 120 | 16 × 25 | 145 |
| | | | | | | | 13 × 25 | 155 | | | 13 × 25 | 140 | 16 × 32 | 175 |
| | | | | | | | | | | | 16 × 25 | 170 | | |
| 33 | 10 × 12 | 160 | 13 × 20 | 180 | 13 × 20 | 160 | 13 × 25 | 200 | 16 × 32 | 195 | 16 × 25 | 190 | 18 × 36 | 250 |
| | | | | | 13 × 25 | 190 | | | | | 16 × 32 | 230 | | |
| 47 | 10 × 15 | 210 | 13 × 25 | 250 | 13 × 20 | 220 | 16 × 25 | 270 | 16 × 36 | 210 | 16 × 25 | 200 | 18 × 40 | 350 |
| | | | | | 13 × 25 | 260 | | | 18 × 36 | 240 | 16 × 32 | 250 | | |
| | | | | | | | | | | | 18 × 36 | 300 | | |
| 68 | 10 × 15 | 241 | 13 × 25 | 270 | 16 × 25 | 280 | 16 × 32 | 300 | 16 × 36 | 320 | 18 × 36 | 325 | 22 × 40 | 380 |
| 100 | 10 × 19 | 305 | 16 × 25 | 390 | 16 × 32 | 400 | 18 × 36 | 440 | 18 × 40 | 300 | 18 × 36 | 290 | | |
| | 13 × 20 | 385 | | | | | | | 22 × 40 | 360 | 22 × 40 | 365 | | |
| 120 | | | | | | | | | | | 18 × 36 | 320 | | |
| | | | | | | | | | | | 18 × 40 | 350 | | |
| 150 | 13 × 25 | 414 | 16 × 32 | 435 | 16 × 36 | 450 | 18 × 40 | 600 | 22 × 40 | 480 | 22 × 40 | 465 | | |
| 220 | 13 × 25 | 495 | 16 × 36 | 700 | 18 × 36 | 675 | 22 × 40 | 800 | | | | | | |
| | 16 × 25 | 590 | | | 18 × 40 | 750 | | | | | | | | |
| 330 | 16 × 25 | 720 | 18 × 40 | 850 | 18 × 40 | 780 | | | | | | | | |
| | | | | | 22 × 40 | 920 | | | | | | | | |
| 470 | 16 × 32 | 875 | 22 × 40 | 980 | | | | | | | | | | |
| 680 | 16 × 36 | 1200 | | | | | | | | | | | | |

Note : * I. D × L : mm

* 2. mA rms at 105°C, 120Hz

SG [Electronic Ballast]

105°C Single-Ended Lead Aluminum Electrolytic Capacitors

Miniature Size Aluminum Electrolytic Capacitors

ELECTRICAL CHARACTERISTICS

Operating Temperature : -40 ~ +105°C / -25 ~ +105°C

Working Voltage : 160 ~ 400V / 450V

Rate Capacitance Range : 4.7 ~ 330μF / 3.3~100μF

Capacitance Tolerance : -20 ~ +20%

DC Leakage Current (μA) : I = 0.06 CV + 10

(After 2 Minute Application of DC Working Voltage at 25°C)

Dissipation Factor : at 120 Hz, 25°C

| | | | | | | |
|-----------|-----|-----|-----|-----|-----|-----|
| WV (V) : | 160 | 200 | 250 | 350 | 400 | 450 |
| D.F (%) : | 15 | 15 | 15 | 20 | 24 | 24 |

For capacitor whose capacitance exceeds 1000μF. The value of D.F(%) is increased by 2% for every addition of 1000μF.

Load Life : 5000 Hours at Assured with Full Rated Maximum Ripple Current Applied

- (a) Capacitance Change : Within 20% of Initial Value
- (b) Dissipation Factor : Not Exceed 200% of Initial Requirement
- (c) Leakage Current : Not Exceed the Initial Requirement

Shelf Life : Hours, No Voltage Applied

- (a) Capacitance Change : Within 20% of Initial Value
- (b) Dissipation Factor : Not Exceed 200 % of Initial Requirement
- (c) Leakage Current : Not Exceed 200% of Initial Requirement



Multiplier for Ripple Current

Frequency coefficient

| Frequency (Hz) | 50,60 | 120 | 300 | 1K | 10K~100K |
|---------------------|-------|------|------|------|----------|
| 6.3~100V Below~68μF | 0.80 | 1.00 | 1.20 | 1.40 | 1.6 |

Temperature coefficient

| Temperature(°C) | 65 | 85 | 105 |
|-----------------|------|------|------|
| Factor | 1.70 | 1.40 | 1.00 |

DIAGRAM OF DIMENSIONS

| Dø | F | dø |
|------|------|------|
| 4.0 | 1.5 | 0.45 |
| 5.0 | 2.0 | 0.5 |
| 6.0 | 2.5 | |
| 8.0 | 3.5 | |
| 10.0 | 5.0 | 0.6 |
| 12.0 | | |
| 13.0 | | |
| 16.0 | 7.5 | 0.8 |
| 18.0 | | |
| 22.0 | 10.0 | 0.8 |

Rubber Stand-off

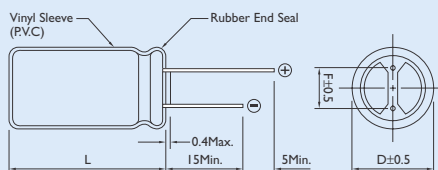

$L \leq 12$ $L + 1.5\text{Max.}$
 $13 \leq L \leq 15$ $L^{+1.0}_{-0.5}$
 $L \geq 16$ $L + 2.0\text{Max.}$

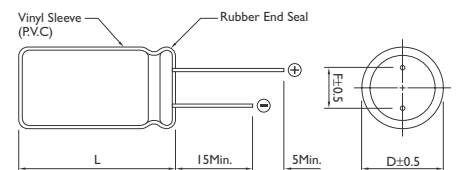

Dimensions : mm



CASE SIZE OF STANDARD PRODUCTS

| CAP. (μF) | RATED VOLTAGE | | | | | | | | |
|-----------|---------------|---------------|-----------|----------|---------------|-----------|----------|---------------|-----------|
| | SIZE | 160 Ripple | Impedance | SIZE | 200 Ripple | Impedance | SIZE | 250 Ripple | Impedance |
| 10 | | | | *10 × 15 | 100 | 2.50 | *10 × 15 | 85 | 4.10 |
| | | | | | | | 10 × 19 | 100 | 3.50 |
| 15 | | | | *10 × 15 | 80 | 5.00 | | | |
| 22 | 10 × 19 | 160 | 1.52 | 10 × 19 | 160 | 1.50 | *10 × 25 | 145 | 2.75 |
| | | | | | | | 13 × 20 | 160 | 2.50 |
| 33 | 10 × 19 | 210 | 1.30 | *10 × 19 | 160 | 1.20 | 13 × 20 | 210 | 1.90 |
| | | | | 13 × 20 | 210 | 0.95 | | | |
| 47 | 13 × 20 | 260 | 0.95 | 13 × 20 | 260 | 0.91 | 13 × 25 | 270 | 1.70 |
| | | | | | | | 16 × 20 | 275 | 1.50 |
| 68 | 13 × 25 | 360 | 0.60 | 13 × 25 | 360 | 0.60 | 16 × 25 | 380 | 0.80 |
| | 16 × 20 | 430 | 0.55 | 16 × 20 | 430 | 0.55 | 18 × 20 | 375 | 0.90 |
| 100 | 16 × 25 | 475 | 0.30 | 16 × 25 | 475 | 0.30 | 16 × 32 | 520 | 0.65 |
| | 18 × 20 | 465 | 0.31 | 18 × 20 | 465 | 0.31 | 18 × 25 | 500 | 0.65 |
| 150 | 16 × 32 | 650 | 0.22 | 18 × 25 | 650 | 0.27 | 18 × 32 | 650 | 0.45 |
| | 18 × 25 | 625 | 0.24 | | | | | | |
| 220 | 16 × 32 | 750 | 0.22 | 18 × 32 | 780 | 0.22 | 18 × 40 | 820 | 0.35 |
| | 18 × 25 | 725 | 0.24 | | | | | | |
| 330 | 18 × 32 | 960 | 0.22 | | | | | | |

Note : * I. D × L : mm

* 2. mA rms at 105°C, 100KHz

* 3. Impedance Spec : 100KHz / 25°C (Ω MAX)

* 4. Down Size : 3000Hrs



CASE SIZE OF STANDARD PRODUCTS

| CAP. (μF) | RATED VOLTAGE | | | | | | | | |
|-----------|---------------|--------|-----------|----------|--------|-----------|----------|--------|-----------|
| | SIZE | 350 | | SIZE | 400 | | SIZE | 450 | |
| | | Ripple | Impedance | | Ripple | Impedance | | Ripple | Impedance |
| 3.3 | | | | | | | 10 × 19 | 60 | 6.50 |
| 4.7 | | | | *10 × 15 | 60 | 3.50 | 13 × 20 | 80 | 3.60 |
| 6.8 | | | | *10 × 15 | 72 | 3.40 | *10 × 19 | 90 | 3.40 |
| 10 | 10 × 19 | 100 | 3.00 | 10 × 19 | 100 | 2.90 | 13 × 20 | 110 | 3.00 |
| 22 | 13 × 20 | 160 | 2.10 | 13 × 25 | 170 | 1.35 | 16 × 25 | 190 | 1.80 |
| | | | | 16 × 20 | 200 | 1.00 | 18 × 20 | 200 | 2.20 |
| 33 | 13 × 25 | 230 | 1.00 | 16 × 25 | 230 | 0.95 | 16 × 32 | 275 | 1.30 |
| | 16 × 20 | 250 | 0.91 | 18 × 20 | 250 | 0.91 | 18 × 25 | 280 | 1.20 |
| 47 | 16 × 25 | 300 | 0.75 | 16 × 32 | 300 | 0.75 | 18 × 32 | 340 | 1.00 |
| | 18 × 20 | 315 | 0.80 | 18 × 25 | 325 | 0.80 | | | |
| 68 | 16 × 32 | 400 | 0.50 | 18 × 36 | 420 | 0.49 | 18 × 40 | 460 | 0.80 |
| | 18 × 25 | 380 | 0.55 | | | | | | |
| 100 | 18 × 32 | 530 | 0.40 | 18 × 40 | 545 | 0.34 | 22 × 40 | 580 | 0.60 |
| 150 | | | | 22 × 40 | 650 | 0.30 | | | |

Note : * 1. D × L : mm

* 2. mA rms at 105°C, 100KHz

* 3. Impedance Spec : 100KHz / 25°C (Ω MAX)

* 4. Down Size : 3000Hrs

Miniature Size Aluminum Electrolytic Capacitors

SA [High Ripple Current and Long load life]

105°C Single-Ended Lead Aluminum Electrolytic Capacitors



DESCRIPTION

High Temperature Load Life at 105°C for 3000~8000 Hours

Frequency coefficient

| Rated voltage(V) | Freq.(Hz) Cap(μF) | 50 | | | | | 120 | | | | | 300 | | | | | 1K | | | | | 10K- | | | | | | | | | |
|------------------|----------------------|------|------|------|------|------|------|------|------|------|------|------|------|------|------|------|------|------|------|------|------|------|------|------|------|------|------|------|------|------|------|
| | | -47 | 0.75 | 1.00 | 1.35 | 1.57 | 2.00 | 0.80 | 1.00 | 1.23 | 1.34 | 1.50 | 0.85 | 1.00 | 1.10 | 1.13 | 1.15 | 0.80 | 1.00 | 1.25 | 1.40 | 1.60 | 0.80 | 1.00 | 1.25 | 1.40 | 1.60 | 0.80 | 1.00 | 1.25 | 1.40 |
| 6.3~100V | -47 | 0.75 | 1.00 | 1.35 | 1.57 | 2.00 | 0.80 | 1.00 | 1.23 | 1.34 | 1.50 | 0.85 | 1.00 | 1.10 | 1.13 | 1.15 | 0.80 | 1.00 | 1.25 | 1.40 | 1.60 | 0.80 | 1.00 | 1.25 | 1.40 | 1.60 | 0.80 | 1.00 | 1.25 | 1.40 | 1.60 |
| | 100~470 | 0.80 | 1.00 | 1.23 | 1.34 | 1.50 | 0.85 | 1.00 | 1.10 | 1.13 | 1.15 | 0.80 | 1.00 | 1.25 | 1.40 | 1.60 | 0.80 | 1.00 | 1.25 | 1.40 | 1.60 | 0.80 | 1.00 | 1.25 | 1.40 | 1.60 | 0.80 | 1.00 | 1.25 | 1.40 | 1.60 |
| | ≥560 | 0.85 | 1.00 | 1.10 | 1.13 | 1.15 | 0.80 | 1.00 | 1.25 | 1.40 | 1.60 | 0.80 | 1.00 | 1.25 | 1.40 | 1.60 | 0.80 | 1.00 | 1.25 | 1.40 | 1.60 | 0.80 | 1.00 | 1.25 | 1.40 | 1.60 | 0.80 | 1.00 | 1.25 | 1.40 | 1.60 |
| 160~450 | 0.47~220 | 0.80 | 1.00 | 1.25 | 1.40 | 1.60 | 0.80 | 1.00 | 1.25 | 1.40 | 1.60 | 0.80 | 1.00 | 1.25 | 1.40 | 1.60 | 0.80 | 1.00 | 1.25 | 1.40 | 1.60 | 0.80 | 1.00 | 1.25 | 1.40 | 1.60 | 0.80 | 1.00 | 1.25 | 1.40 | 1.60 |
| | ≥270 | 0.90 | 1.00 | 1.10 | 1.13 | 1.15 | 0.80 | 1.00 | 1.25 | 1.40 | 1.60 | 0.80 | 1.00 | 1.25 | 1.40 | 1.60 | 0.80 | 1.00 | 1.25 | 1.40 | 1.60 | 0.80 | 1.00 | 1.25 | 1.40 | 1.60 | 0.80 | 1.00 | 1.25 | 1.40 | 1.60 |

Temperature coefficient

| Temperature(°C) | ~55 | 60 | 70 | 85 | 105 |
|-----------------|------|------|------|------|------|
| Factor | 2.23 | 2.17 | 2.00 | 1.75 | 1.00 |

DIAGRAM OF DIMENSIONS

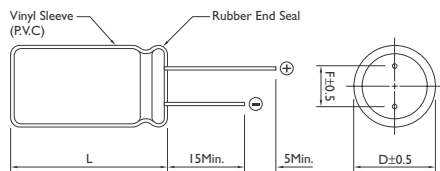

ELECTRICAL CHARACTERISTICS

Operating Temperature : -40° ~ +105°C -25° ~ +105°C

Working Voltage : 6.3 ~ 100V 160 ~ 450V

Rate Capacitance Range : 0.1 ~ 22000μF

Capacitance Tolerance : -20 ~ +20%

DC Leakage Current (μA) : $I \leq 0.03 CV$ or $4(\mu A)$ after 1 minute, $I \leq 0.04 CV + 40(\mu A)$ after 1 minute (Measurements shall be Made After a 1 Minute Charge at Rated Working Voltage)

Dissipation Factor : at 120 Hz, 25°C

| WV (V) | 6.3 | 10 | 16 | 25 | 35 | 50 | 63 | 100 | 160 | 200 | 250 | 315 | 400 | 450 |
|---------|-----|----|----|----|----|----|----|-----|-----|-----|-----|-----|-----|-----|
| D.F (%) | 28 | 24 | 20 | 16 | 14 | 12 | 10 | 8 | 20 | 20 | 20 | 25 | 25 | 25 |

For capacitor whose capacitance exceeds 1000μF. The value of D.F(%) is increased by 2% for every addition of 1000μF.

| WV (V) | 6.3 | 10 | 16 | 25 | 35 | 50 | 63 | 100 |
|-------------------------------|-----|----|----|----|----|----|----|-----|
| Impedance : Z -25°C / Z +20°C | 5 | 4 | 3 | 2 | 2 | 2 | 2 | 2 |
| Impedance : Z -40°C / Z +20°C | 12 | 10 | 8 | 5 | 4 | 3 | 3 | 3 |

| WV (V) | 160 | 200 | 250 | 350 | 400 | 450 |
|-------------------------------|-----|-----|-----|-----|-----|-----|
| Impedance : Z -25°C / Z +20°C | 3 | 3 | 4 | 4 | 6 | 15 |

Load Life : At 105°C Assured with Full Rated Maximum Ripple Current Applied

ø5~ø6=3000 hours.

ø8~ø10=5000 hours.

>ø12=8000 hours.

(a) Capacitance Change : Within 20% of Initial Value

(b) Dissipation Factor : Not Exceed 200% of Initial Requirement

(c) Leakage Current : Not Exceed the Initial Requirement

Shelf Life : 1000 Hours, No Voltage Applied, at 105°C

(a) Capacitance Change : Within 20% of Initial Value

(b) Dissipation Factor : Not Exceed 200 % of Initial Requirement

(c) Leakage Current : Not Exceed 200% of Initial Requirement

Dimensions : mm

Rubber Stand-off

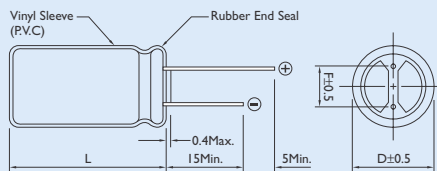

| | |
|---------------------|----------------------|
| $L \leq 12$ | $L + 1.5\text{Max.}$ |
| $13 \leq L \leq 15$ | $L^{+1.0}_{-0.5}$ |
| $L \geq 16$ | $L + 2.0\text{Max.}$ |

| Dø | F | dø |
|------|------|------|
| 4.0 | 1.5 | 0.45 |
| 5.0 | 2.0 | 0.5 |
| 6.0 | 2.5 | |
| 8.0 | 3.5 | |
| 10.0 | 5.0 | 0.6 |
| 12.0 | | |
| 13.0 | | |
| 16.0 | 7.5 | 0.8 |
| 18.0 | | |
| 22.0 | 10.0 | 0.8 |



CASE SIZE OF STANDARD PRODUCTS $D\phi \geq 6\text{mm}$ with Safety Vent at Can Bottom

| CAP. (μF) | RATED VOLTAGE WV | | | | | | | | | |
|------------------------|--------------------|--------------|--------------------|--------------|--------------------|--------------|--------------------|--------------|--------------------|--------------|
| | 6.3 | | 10 | | 16 | | 25 | | 35 | |
| | Size | Ripple | Size | Ripple | Size | Ripple | Size | Ripple | Size | Ripple |
| 0.1 | | | | | | | | | | |
| 0.22 | | | | | | | | | | |
| 0.33 | | | | | | | | | | |
| 0.47 | | | | | | | | | | |
| 1 | | | | | | | | | | |
| 2.2 | | | | | | | | | | |
| 3.3 | | | | | | | | | | |
| 4.7 | | | | | | | 5 x 11 | 18 | 5 x 11 | 21 |
| 10 | | | | | 5 x 11 | 24 | 5 x 11 | 30 | 5 x 11 | 33 |
| 22 | 5 x 11 | 21 | 5 x 11 | 33 | 5 x 11 | 45 | 5 x 11 | 48 | 5 x 11 | 51 |
| 33 | 5 x 11 | 33 | 5 x 11 | 48 | 5 x 11 | 54 | 5 x 11 | 57 | 5 x 11 | 63 |
| 47 | 5 x 11 | 45 | 5 x 11 | 57 | 5 x 11 | 66 | 5 x 11 | 69 | 6 x 11 | 84 |
| 100 | 5 x 11 | 78 | 5 x 11 | 87 | 6 x 11 | 105 | 6 x 11 | 111 | 8 x 11 | 138 |
| 220 | 6 x 11 | 129 | 6 x 11 | 138 | 8 x 11 | 180 | 8 x 11 | 192 | 10 x 12 | 222 |
| 330 | 6 x 11 | 159 | 8 x 11 | 198 | 8 x 11 | 216 | 10 x 12 | 252 | 10 x 15 | 294 |
| 470 | 8 x 11 | 216 | 8 x 11 | 234 | 10 x 12 | 282 | 10 x 15 | 324 | 10 x 19 | 384 |
| 1000 | 10 x 12 | 342 | 10 x 15 | 378 | 10 x 19 | 474 | 12 x 20 | 570 | 13 x 25 | 660 |
| 2200 | 13 x 20 | 630 | 13 x 20 | 660 | 13 x 25 | 810 | 16 x 25 | 730 | 16 x 32 | 708 |
| 3300 | 13 x 20 | 750 | 13 x 25 | 840 | 16 x 25 | 1020 | 16 x 32 | 1170 | 18 x 36 22 x 30 | 1330 1330 |
| 4700 | 16 x 25 | 1020 | 16 x 25 | 1080 | 16 x 32 | 260 | 18 x 36 22 x 30 | 1410 1410 | 18 x 40 22 x 35 | 1490 1470 |
| 6800 | 16 x 25 | 1140 | 16 x 32 | 1290 | 18 x 36 22 x 30 | 1500 1480 | 22 x 40 | 1550 | | |
| 10000 | 16 x 32 | 1350 | 18 x 36 22 x 30 | 1500 1480 | 18 x 40 22 x 35 | 1580 1560 | | | | |
| 12000 | 16 x 36 | 1470 | 18 x 36 22 x 30 | 1560 1530 | 22 x 40 | 1640 | | | | |
| 15000 | 18 x 36 22 x 30 | 1508 1590 | 18 x 40 22 x 35 | 1632 1600 | | | | | | |
| 18000 | 18 x 40 22 x 35 | 1650 1650 | 22 x 40 | 1710 | | | | | | |
| 22000 | 22 x 40 | 1710 | | | | | | | | |

Note : * 1. D x L : mm

* 2. mA rms at 105°C, 120Hz



CASE SIZE OF STANDARD PRODUCTS $D\phi \geq 6\text{mm}$ with Safety Vent at Can Bottom

| CAP. (μF) | RATED VOLTAGE WV | | | | | | | | | |
|------------------------|------------------|--------|---------|--------|---------|--------|---------|--------|---------|--------|
| | 50 | | 63 | | 100 | | 160 | | 200 | |
| | Size | Ripple | Size | Ripple | Size | Ripple | Size | Ripple | Size | Ripple |
| 0.1 | 5 x 11 | 1.1 | | | 5 x 11 | 1.1 | | | | |
| 0.22 | 5 x 11 | 2.3 | | | 5 x 11 | 2.3 | | | | |
| 0.33 | 5 x 11 | 3.5 | | | 5 x 11 | 3.5 | | | | |
| 0.47 | 5 x 11 | 5 | | | 5 x 11 | 5 | 6 x 11 | 7.2 | 6 x 11 | 7.2 |
| 1 | 5 x 11 | 10 | | | 5 x 11 | 10 | 6 x 11 | 10.2 | 6 x 11 | 10.2 |
| 2.2 | 5 x 11 | 14 | | | 5 x 11 | 18 | 6 x 11 | 16 | 6 x 11 | 16 |
| 3.3 | 5 x 11 | 21 | | | 5 x 11 | 24 | 8 x 11 | 21 | 8 x 11 | 21 |
| 4.7 | 5 x 11 | 24 | 5 x 11 | 27 | 5 x 11 | 27 | 8 x 11 | 24 | 10 x 12 | 27 |
| 10 | 5 x 11 | 39 | 5 x 11 | 42 | 6 x 11 | 45 | 10 x 12 | 39 | 10 x 15 | 42 |
| 22 | 6 x 11 | 57 | 6 x 11 | 69 | 8 x 11 | 78 | 10 x 19 | 66 | 10 x 22 | 66 |
| 33 | 6 x 11 | 75 | 8 x 11 | 84 | 10 x 12 | 102 | 13 x 20 | 90 | 13 x 25 | 96 |
| 47 | 6 x 11 | 90 | 8 x 11 | 114 | 10 x 15 | 138 | 13 x 25 | 108 | 13 x 25 | 108 |
| 100 | 8 x 11 | 150 | 10 x 12 | 180 | 13 x 20 | 240 | 16 x 25 | 180 | 16 x 32 | 198 |
| 150 | | | | | | | 16 x 36 | 252 | 18 x 36 | 270 |
| | | | | | | | | | 22 x 30 | 270 |
| 220 | 10 x 15 | 264 | 10 x 19 | 294 | 16 x 25 | 436 | 18 x 36 | 306 | 18 x 40 | 312 |
| | | | | | | | 22 x 30 | 306 | 22 x 35 | 312 |
| 270 | | | | | | | 18 x 40 | 324 | 22 x 40 | 342 |
| | | | | | | | 22 x 35 | 324 | | |
| 330 | 10 x 19 | 398 | 13 x 20 | 408 | 16 x 25 | 516 | 22 x 40 | 360 | | |
| 470 | 13 x 20 | 456 | 13 x 25 | 528 | 16 x 32 | 660 | | | | |
| 1000 | 16 x 25 | 810 | 18 x 32 | 930 | 18 x 40 | 1010 | | | | |
| | | | | | 22 x 35 | 1010 | | | | |
| 2200 | 18 x 36 | 1250 | 18 x 40 | 1320 | | | | | | |
| | 22 x 30 | 1250 | 22 x 35 | 1350 | | | | | | |
| 3300 | 22 x 40 | 1420 | | | | | | | | |

Note : * 1. D x L : mm

* 2. mA rms at 105°C, 120Hz



CASE SIZE OF STANDARD PRODUCTS $D\phi \geq 6\text{mm}$ with Safety Vent at Can Bottom

| CAP. (μF) | RATED VOLTAGE WV | | | | | | | | | |
|------------------------|------------------|--------|---------|--------|---------|--------|---------|--------|---------|--------|
| | 250 | | 315 | | 350 | | 400 | | 450 | |
| | Size | Ripple | Size | Ripple | Size | Ripple | Size | Ripple | Size | Ripple |
| 0.47 | 6 x 11 | 7.2 | | | | | | | | |
| 1 | 6 x 11 | 10.2 | 6 x 11 | 10.2 | 8 x 11 | 10.8 | 8 x 11 | 10.8 | 10 x 12 | 11.4 |
| 2.2 | 8 x 11 | 18 | 8 x 11 | 18 | 10 x 12 | 18 | 10 x 12 | 18 | 10 x 19 | 17.4 |
| 3.3 | 10 x 12 | 21 | 10 x 12 | 21 | 10 x 15 | 21 | 10 x 19 | 21 | 10 x 19 | 21 |
| 4.7 | 10 x 12 | 27 | 10 x 15 | 45 | 10 x 15 | 27 | 10 x 19 | 27 | 13 x 20 | 30 |
| 10 | 10 x 19 | 42 | 10 x 19 | 42 | 13 x 20 | 42 | 13 x 20 | 42 | 13 x 25 | 45 |
| 22 | 13 x 25 | 78 | 13 x 25 | 72 | 13 x 25 | 66 | 16 x 25 | 66 | 16 x 32 | 66 |
| 33 | 13 x 25 | 96 | 16 x 25 | 90 | 16 x 32 | 84 | 16 x 32 | 84 | 18 x 36 | 90 |
| | | | | | | | | | 22 x 30 | 84 |
| 47 | 16 x 25 | 126 | 16 x 30 | 144 | 18 x 36 | 132 | 18 x 36 | 132 | 22 x 40 | 138 |
| | | | | | 22 x 30 | 132 | 22 x 30 | 132 | | |
| 100 | 18 x 36 | 204 | 18 x 40 | 204 | 22 x 40 | 216 | | | | |
| | 22 x 30 | 204 | 22 x 35 | 204 | | | | | | |
| 150 | 18 x 40 | 276 | 22 x 40 | 270 | | | | | | |
| | 22 x 35 | 276 | | | | | | | | |
| 220 | 22 x 40 | 320 | | | | | | | | |

Note : * 1. D x L : mm

* 2. mA rms at 105°C, 120Hz

Miniature Size Aluminum Electrolytic Capacitors

SP [Miniature and Long Life]

105°C Single-Ended Lead Aluminum Electrolytic Capacitors For Electronic Ballast



DESCRIPTION

Applicable for Electronic Ballast

High Temperature Load Life at 105°C for 8000~10000 Hours

Frequency coefficient

| | | | | |
|---------------|------|------|------|------|
| Frequency(Hz) | 120 | 1K | 10K | 100K |
| Coefficient | 0.50 | 0.80 | 0.90 | 1.00 |

Temperature coefficient

| | | | |
|-----------------|------|------|------|
| Temperature(°C) | 65 | 85 | 105 |
| Factor | 1.70 | 1.40 | 1.00 |

DIAGRAM OF DIMENSIONS



ELECTRICAL CHARACTERISTICS

Operating Temperature : -40° ~ +105°C -25° ~ +105°C

Working Voltage : 160 ~ 400V 450V

Rate Capacitance Range : 3.3 ~ 330μF

Capacitance Tolerance : -20 ~ +20%

DC Leakage Current (μA) : I = 0.04 + 100 CV(μA)

(Measurements shall be Made After a 2 Minute Charge at Rated Working Voltage)

Dissipation Factor : at 120 Hz, 25°C

| | | | | |
|-----------|-----|-----|-----|-----|
| WV (V) : | 160 | 200 | 400 | 450 |
| D.F (%) : | 20 | 20 | 24 | 24 |

| | | | | |
|---------------------|-----|-----|-----|-----|
| WV (V) : | 160 | 200 | 400 | 450 |
| Z - 25°C / Z + 20°C | 3 | 3 | 5 | 6 |
| Z - 40°C / Z + 20°C | 6 | 6 | 6 | |

Load Life : 8000~10000 Hours at 105°C Assured with Full Rated Maximum Ripple Current Applied

- (a) Capacitance Change : Within 20% of Initial Value
- (b) Dissipation Factor : Not Exceed 200% of Initial Requirement
- (c) Leakage Current : Not Exceed the Initial Requirement

Shelf Life : 1000 Hours, No Voltage Applied, at 105°C

- (a) Capacitance Change : Within 20% of Initial Value
- (b) Dissipation Factor : Not Exceed 200 % of Initial Requirement
- (c) Leakage Current : Not Exceed 200% of Initial Requirement

Dimensions : mm

Rubber Stand-off



L ≤ 12 L + 1.5Max.
 13 ≤ L ≤ 15 L +1.0
 L -0.5
 L ≥ 16 L + 2.0Max.

| Dø | F | dø |
|------|------|------|
| 4.0 | 1.5 | 0.45 |
| 5.0 | 2.0 | 0.5 |
| 6.0 | 2.5 | |
| 8.0 | 3.5 | |
| 10.0 | 5.0 | 0.6 |
| 12.0 | | |
| 13.0 | | |
| 16.0 | 7.5 | 0.8 |
| 18.0 | | |
| 22.0 | 10.0 | 0.8 |



CASE SIZE OF STANDARD PRODUCTS AND PERMISSIBLE RIPPLE CURRENT

| CAP. (μ F) | RATED VOLTAGE WV | | | | | |
|-----------------|------------------|--------|-----------|---------|--------|-----------|
| | 160 | | | 200 | | |
| | Size | Ripple | Impedance | Size | Ripple | Impedance |
| 22 | | | | 10 x 19 | 440 | 1.30 |
| 33 | 10 x 19 | 500 | 1.30 | 10 x 19 | 520 | 0.91 |
| | | | | 13 x 20 | 580 | 0.91 |
| 47 | 10 x 19 | 580 | 0.96 | 13 x 20 | 660 | 0.91 |
| | 13 x 20 | 660 | 0.96 | | | |
| 68 | 12 x 25 | 720 | 0.64 | 13 x 25 | 720 | 0.63 |
| | 16 x 20 | 760 | 0.64 | 16 x 20 | 760 | 0.56 |
| 100 | 13 x 25 | 970 | 0.48 | 16 x 25 | 1120 | 0.27 |
| | 16 x 20 | 1120 | 0.56 | | | |
| | 16 x 25 | 1120 | 0.48 | | | |
| | 18 x 20 | 1120 | 0.56 | | | |
| 150 | 16 x 25 | 1200 | 0.40 | 16 x 32 | 1280 | 0.22 |
| | 16 x 32 | 1300 | 0.40 | | | |
| | 18 x 25 | 1300 | 0.40 | | | |
| 220 | 16 x 32 | 1300 | 0.27 | | | |
| | 18 x 25 | 1300 | 0.36 | | | |
| 330 | 18 x 36 | 1380 | 0.21 | | | |

Note : * 1. D x L : mm

* 2. mA rms at 105°C, 120Hz



CASE SIZE OF STANDARD PRODUCTS AND PERMISSIBLE RIPPLE CURRENT

| CAP. (μ F) | RATED VOLTAGE WV | | | | | |
|-----------------|------------------|--------|-----------|---------|--------|-----------|
| | 400 | | | 450 | | |
| | Size | Ripple | Impedance | Size | Ripple | Impedance |
| 3.3 | | | | 10 x 15 | 100 | 7.00 |
| 4.7 | | | | 10 x 19 | 140 | 5.10 |
| 6.8 | 10 x 19 | 150 | 4.80 | 10 x 19 | 150 | 4.80 |
| | | | | 13 x 20 | 180 | 4.20 |
| 10 | 10 x 19 | 180 | 2.90 | 13 x 20 | 310 | 2.50 |
| 22 | 16 x 20 | 300 | 0.95 | 16 x 25 | 560 | 1.70 |
| | | | | 18 x 20 | 550 | 2.10 |
| 33 | 16 x 25 | 520 | 0.91 | 16 x 32 | 620 | 1.10 |
| | | | | 18 x 25 | 590 | 1.10 |
| 47 | 16 x 32 | 700 | 0.68 | 16 x 36 | 880 | 0.93 |
| | | | | 18 x 32 | 880 | 0.93 |
| 68 | 18 x 32 | 870 | 0.63 | | | |

Note : * 1. D x L : mm

* 2. mA rms at 105°C, 120Hz

Miniature Size Aluminum Electrolytic Capacitors

SB [For Low Leakage Current]

105°C Single-Ended Lead Aluminum Electrolytic Capacitors

ELECTRICAL CHARACTERISTICS

Operating Temperature : -40° ~ +105°C

Working Voltage : 6.3 ~ 100V

Rate Capacitance Range : 0.1 ~ 4700μF

Capacitance Tolerance : -20 ~ +20%

DC Leakage Current (μA) : I = 0.002CV (μA) or 0.4μA Whichever is greater.
(After 2 Minutes Application of DC Working Voltage at 25°C)

Equivalent Series Resistance (E.S.R, at 120Hz):

When measured at 25°C and 1 KHz E.S.R value shall not exceed the value given in the table on the next page.

| | | | | | |
|-----------|-----|----|----|----|----------|
| WV (V) : | 6.3 | 10 | 16 | 25 | 35 ~ 100 |
| D.F (%) : | 20 | 16 | 13 | 12 | 10 |

For capacitor whose capacitance exceeds 1000μF. The value of D.F(%) is increased by 2% for every addition of 1000μF.

Load Life : 1000 Hours at 105°C Assured with Full Rated Maximum Ripple Current Applied

- (a) Capacitance Change : Within 25% of Initial Value
- (b) Dissipation Factor : Not Exceed 200% of Initial Requirement
- (c) Leakage Current : Not Exceed the Initial Requirement

Shelf Life : 500 Hours, No Voltage Applied, at 105°C

- (a) Capacitance Change : Within 25% of Initial Value
- (b) Dissipation Factor : Not Exceed 200% of Initial Requirement
- (c) Leakage Current : Not Exceed 200% of Initial Requirement

| | | | | | |
|---------------------------------|-----|----|----|----|----------|
| WV (V) : | 6.3 | 10 | 16 | 25 | 35 ~ 100 |
| Impedance : Z - 40°C / Z + 20°C | 4 | 4 | 3 | 3 | 3 |



DESCRIPTION

Used in where low leakage current is essential as in coupling of pre-amplifies.

Very low leakage current remains even after prolonged storage.

Multiplier for Ripple Current

Frequency coefficient

| Frequency(Hz) | 50 | 120 | 300 | 1K | 10K | 100K |
|---------------|------|------|------|------|------|------|
| 6.3~25V | 0.85 | 1.00 | 1.04 | 1.08 | 1.19 | 1.19 |
| 26~50V | 0.80 | 1.00 | 1.30 | 1.40 | 1.43 | 1.43 |
| 50~100V | 0.77 | 1.00 | 1.34 | 1.43 | 1.48 | 1.48 |

Temperature coefficient

| Temperature(°C) | 65 | 85 | 105 |
|-----------------|------|------|------|
| Factor | 1.50 | 1.20 | 1.00 |

DIAGRAM OF DIMENSIONS



Dimensions : mm

| Dø | F | dø |
|------|------|------|
| 4.0 | 1.5 | 0.45 |
| 5.0 | 2.0 | 0.5 |
| 6.0 | 2.5 | |
| 8.0 | 3.5 | |
| 10.0 | 5.0 | 0.6 |
| 12.0 | | |
| 13.0 | | |
| 16.0 | 7.5 | 0.8 |
| 18.0 | | |
| 22.0 | 10.0 | 0.8 |



CASE SIZE OF STANDARD PRODUCTS $D\phi \geq 6\text{mm}$ with Safety Vent at Can Bottom

| CAP. (μF) | RATED VOLTAGE WV | | | | | | | | | | | | | |
|------------------------|------------------|---------------------|--------------------|------|------|-----------------|---------------------|--------------------|------|------|-----------------|---------------------|--------------------|-------------|
| | SIZE | 6.3 | | | | SIZE | 10 | | | | SIZE | 16 | | |
| | Ripple 120Hz | Impedance 10K Hz | ESR 120Hz 1K Hz | | | Ripple 120Hz | Impedance 10K Hz | ESR 120Hz 1K Hz | | | Ripple 120Hz | Impedance 10K Hz | ESR 120Hz 1K Hz | |
| 0.1 | | | | | | | | | | | | | | |
| 0.15 | | | | | | | | | | | | | | |
| 0.22 | | | | | | | | | | | | | | |
| 0.33 | | | | | | | | | | | | | | |
| 0.47 | | | | | | | | | | | | | | |
| 0.56 | | | | | | | | | | | | | | |
| 0.68 | | | | | | | | | | | | | | |
| 1.0 | | | | | | | | | | | | | | |
| 1.5 | | | | | | | | | | | | | | |
| 2.2 | | | | | | | | | | | | | | |
| 3.3 | | | | | | | | | | | | | | |
| 4.7 | | | | | | | | | | | | | | |
| 6.8 | | | | | | | | | | | | | | |
| 10 | | | | | | | | | | | 5x11 | 40 | 5.00 | 17.00 11.30 |
| 15 | | | | | | | | | | | 5x11 | 56 | 4.43 | 10.60 7.07 |
| 22 | | | | | | 5x11 | 68 | 4.01 | 7.83 | 5.22 | 6x11 | 70 | 3.70 | 7.23 4.82 |
| 33 | | | | | | 6x11 | 78 | 2.67 | 5.22 | 3.48 | 6x11 | 95 | 2.46 | 4.82 3.21 |
| 47 | | | | | | 6x11 | 106 | 1.87 | 3.66 | 2.44 | 8x11 | 122 | 1.73 | 3.38 2.25 |
| 68 | 6x11 | 80 | 1.50 | 3.00 | 2.00 | 6x11 | 142 | 1.29 | 2.53 | 1.68 | 8x11 | 168 | 1.20 | 2.34 1.56 |
| 100 | 6x11 | 126 | 0.88 | 1.72 | 1.15 | 8x11 | 179 | 0.87 | 1.72 | 1.14 | 10x12 | 264 | 0.81 | 1.59 1.06 |
| 150 | 8x11 | 196 | 0.59 | 1.15 | 0.77 | 10x12 | 280 | 0.58 | 1.14 | 0.76 | 10x15 | 416 | 0.53 | 1.06 0.70 |
| 220 | 10x12 | 272 | 0.40 | 0.78 | 0.52 | 10x15 | 355 | 0.40 | 0.78 | 0.52 | 10x19 | 553 | 0.36 | 0.72 0.48 |
| 330 | 10x15 | 388 | 0.26 | 0.52 | 0.34 | 10x19 | 480 | 0.26 | 0.52 | 0.34 | 13x20 | 732 | 0.24 | 0.48 0.32 |
| 470 | 10x19 | 507 | 0.18 | 0.36 | 0.24 | 13x20 | 640 | 0.18 | 0.36 | 0.24 | 13x20 | 1040 | 0.16 | 0.33 0.22 |
| 680 | 13x20 | 700 | 0.12 | 0.25 | 0.16 | 13x25 | 848 | 0.12 | 0.25 | 0.16 | 13x25 | 1280 | 0.11 | 0.23 0.15 |
| 820 | 13x25 | 850 | 0.11 | 0.21 | 0.14 | 13x25 | 980 | 0.11 | 0.21 | 0.14 | 16x25 | 1450 | 0.09 | 0.18 0.12 |
| 1000 | 13x25 | 896 | 0.08 | 0.17 | 0.11 | 13x25 | 1081 | 0.08 | 0.17 | 0.11 | 16x25 | 1700 | 0.06 | 0.14 0.10 |
| 1500 | 13x25 | 1204 | 0.05 | 0.11 | 0.07 | 16x25 | 1376 | 0.05 | 0.11 | 0.07 | 16x32 | 1750 | 0.06 | 0.10 0.06 |
| 2200 | 16x25 | 1513 | 0.04 | 0.09 | 0.06 | 16x32 | 1680 | 0.04 | 0.09 | 0.06 | 18x36 | 1900 | 0.05 | 0.08 0.06 |
| 3300 | 16x36 | 1902 | 0.04 | 0.06 | 0.04 | 16x36 | 2155 | 0.03 | 0.06 | 0.04 | 18x40 | 2250 | 0.04 | 0.06 0.04 |
| 4700 | 18x36 | 2272 | 0.02 | 0.05 | 0.03 | 18x36 | 2560 | 0.02 | 0.05 | 0.03 | | | | |

Note : * 1. D x L : mm
 * 2. Ripple Current mA rms at 105°C, 100Hz
 * 3. Impedance : (ohm) 25°C/10KHz
 * 4. ESR : (ohm) 25°C/120Hz and 1KHz



CASE SIZE OF STANDARD PRODUCTS $D\phi \geq 6\text{mm}$ with Safety Vent at Can Bottom

CAP. (μF) RATED VOLTAGE WV

| | 25 | | | | 35 | | | | 50 | | | | | | |
|------|-------|-----------------|---------------------|--------------------|-------|-----------------|---------------------|--------------------|-------|-----------------|---------------------|--------------------|-------|-------|------|
| | SIZE | Ripple 120Hz | Impedance 10K Hz | ESR 120Hz 1K Hz | SIZE | Ripple 120Hz | Impedance 10K Hz | ESR 120Hz 1K Hz | SIZE | Ripple 120Hz | Impedance 10K Hz | ESR 120Hz 1K Hz | | | |
| 0.1 | | | | | | | | | 5x11 | 1 | 323.00 | 510.0 | 215.0 | | |
| 0.15 | | | | | | | | | 5x11 | 4 | 270.00 | 355.0 | 126.0 | | |
| 0.22 | | | | | | | | | 5x11 | 4 | 235.00 | 223.0 | 80.00 | | |
| 0.33 | | | | | | | | | 5x11 | 6 | 175.00 | 185.0 | 65.20 | | |
| 0.47 | | | | | | | | | 5x11 | 7 | 90.00 | 96.00 | 45.70 | | |
| 0.56 | | | | | | | | | 5x11 | 7 | 40.00 | 50.00 | 33.00 | | |
| 0.68 | | | | | | | | | 5x11 | 9 | 38.50 | 47.00 | 31.20 | | |
| 1.0 | | | | | | | | | 5x11 | 18 | 32.70 | 43.40 | 25.30 | | |
| 1.5 | | | | | | | | | 5x11 | 24 | 28.50 | 35.20 | 21.70 | | |
| 2.2 | | | | | | | | | 5x11 | 30 | 22.40 | 32.50 | 17.50 | | |
| 3.3 | | | | | | | | | 5x11 | 36 | 17.40 | 24.30 | 13.20 | | |
| 4.7 | 5x11 | 27 | 8.00 | 20.00 | 13.00 | 5x11 | 40 | 14.40 | 28.20 | 18.80 | 6x11 | 45 | 12.50 | 20.70 | 9.20 |
| 6.8 | 5x11 | 42 | 7.60 | 19.50 | 11.00 | 5x11 | 45 | 10.00 | 19.50 | 13.00 | 6x11 | 55 | 10.00 | 19.50 | 9.00 |
| 10 | 6x11 | 63 | 6.80 | 13.20 | 8.84 | 6x11 | 67 | 6.80 | 13.20 | 8.84 | 8x11 | 82 | 6.80 | 13.20 | 8.84 |
| 15 | 6x11 | 67 | 4.53 | 8.84 | 5.89 | 8x11 | 75 | 4.53 | 8.80 | 5.89 | 8x11 | 97 | 4.56 | 8.84 | 5.89 |
| 22 | 8x11 | 84 | 3.08 | 6.02 | 4.01 | 8x11 | 97 | 3.08 | 6.02 | 4.01 | 10x12 | 127 | 3.08 | 6.02 | 4.01 |
| 33 | 8x11 | 102 | 2.05 | 4.01 | 2.67 | 10x12 | 139 | 2.05 | 4.01 | 2.67 | 10x15 | 156 | 2.05 | 4.01 | 2.67 |
| 47 | 10x12 | 141 | 1.44 | 2.82 | 1.88 | 10x12 | 166 | 1.44 | 2.82 | 1.88 | 10x15 | 217 | 1.44 | 2.82 | 1.88 |
| 68 | 10x12 | 190 | 1.00 | 1.95 | 1.30 | 10x15 | 238 | 1.00 | 1.95 | 1.30 | 10x19 | 300 | 1.00 | 1.95 | 1.30 |
| 100 | 10x15 | 277 | 0.67 | 1.32 | 0.88 | 10x19 | 310 | 0.67 | 1.32 | 0.88 | 13x25 | 390 | 0.67 | 1.32 | 0.88 |
| 150 | 10x19 | 455 | 0.44 | 0.88 | 0.58 | 13x20 | 491 | 0.44 | 0.88 | 0.58 | 13x25 | 569 | 0.44 | 0.88 | 0.58 |
| 220 | 13x20 | 590 | 0.30 | 0.60 | 0.40 | 13x25 | 630 | 0.30 | 0.60 | 0.40 | 16x25 | 910 | 0.30 | 0.60 | 0.40 |
| 330 | 13x25 | 754 | 0.20 | 0.40 | 0.26 | 16x25 | 771 | 0.20 | 0.40 | 0.26 | 16x32 | 986 | 0.20 | 0.40 | 0.26 |
| 470 | 16x25 | 1110 | 0.13 | 0.28 | 0.18 | 16x25 | 1150 | 0.15 | 0.28 | 0.18 | 16x36 | 1249 | 0.13 | 0.28 | 0.18 |
| 680 | 16x32 | 1385 | 0.09 | 0.19 | 0.12 | 16x3 | 1462 | 0.09 | 0.19 | 0.12 | 16x36 | 1870 | 0.09 | 0.19 | 0.12 |
| 820 | 16x32 | 1540 | 0.08 | 0.15 | 0.10 | 16x36 | 1630 | 0.08 | 0.15 | 0.10 | 16x36 | 1950 | 0.08 | 0.15 | 0.10 |
| 1000 | 16x36 | 1710 | 0.06 | 0.13 | 0.08 | 18x36 | 1723 | 0.06 | 0.13 | 0.08 | 18x40 | 2070 | 0.06 | 0.13 | 0.08 |
| 1500 | 16x36 | 1779 | 0.03 | 0.08 | 0.05 | 18x4 | 2006 | 0.03 | 0.08 | 0.05 | | | | | |
| 2200 | 18x40 | 2174 | 0.03 | 0.06 | 0.04 | | | | | | | | | | |
| 3300 | | | | | | | | | | | | | | | |
| 4700 | | | | | | | | | | | | | | | |

Note : * 1. D x L : mm

* 2. Ripple Current mA rms at 105°C, 100Hz

* 3. Impedance : (ohm) 25°C/10KHz

* 4. ESR : (ohm) 25°C/120Hz and 1KHz

Miniature Size Aluminum Electrolytic Capacitors

SR [For Horizontal Deflection]

Bi-Polarized Capacitors for Horizontal Deflection Circuits of TV Sets



DESCRIPTION

Non-Polar Type for Used in Horizontal Deflection Current

Correction at High Frequency and High Ripple Currents

Frequency coefficient

| | | | | |
|---------------|------|------|--------|--------|
| Frequency(Hz) | 60 | 120 | 400~1K | 15.75K |
| Coefficient | 0.40 | 0.40 | 0.80 | 1.00 |

Temperature coefficient

| | | | |
|-----------------|------|------|------|
| Temperature(°C) | 65 | 70 | 85 |
| Factor | 1.15 | 1.00 | 0.80 |

DIAGRAM OF DIMENSIONS

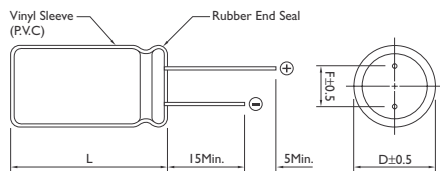

ELECTRICAL CHARACTERISTICS

Operating Temperature : -40° ~ +85°C

Working Voltage : 25, 35, 50V

Rate Capacitance Range : 2.2 ~ 47μF

Capacitance Tolerance : -20 ~ +20%

DC Leakage Current (μA) : 100μA Max.

(After 5 Minutes in Both Direction, at 25°C)

Dissipation Factor : at 120 Hz, 25°C

| | | | |
|-----------|----|----|----|
| WV (V) : | 25 | 35 | 50 |
| D.F (%) : | 5 | 5 | 5 |

Load Life : 1000 Hours at 70°C with Permissible Ripple Current at 15.75 KHz

(Polarity Inverted Every 250 Hours)

- (a) Capacitance Change : Within 20% of Initial Value
- (b) Dissipation Factor : Not Exceed 200% of Initial Requirement
- (c) Leakage Current : Not Exceed the Initial Requirement

Shelf Life : 500 Hours, No Voltage Applied, at 85°C

- (a) Capacitance Change : Within 20% of Initial Value
- (b) Dissipation Factor : Not Exceed 200% of Initial Requirement
- (c) Leakage Current : Not Exceed 200% of Initial Requirement

Rubber Stand-off

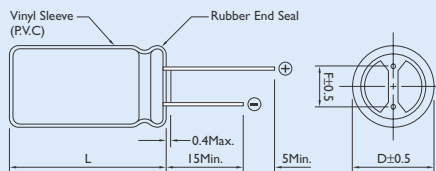

L ≤ 12 L + 1.5Max.
 13 ≤ L ≤ 15 L +1.0 / -0.5
 L ≥ 16 L + 2.0Max.

Dimensions : mm

| Dø | F | dø |
|------|------|------|
| 4.0 | 1.5 | 0.45 |
| 5.0 | 2.0 | 0.5 |
| 6.0 | 2.5 | |
| 8.0 | 3.5 | |
| 10.0 | 5.0 | 0.6 |
| 12.0 | | |
| 13.0 | | |
| 16.0 | 7.5 | 0.8 |
| 18.0 | | |
| 22.0 | 10.0 | 0.8 |



CASE SIZE & PERMISSIBLE RIPPLE CURRENT OF STANDARD PRODUCTS

| CAP. (μ F) | RATED VOLTAGE WV | | | | | |
|-----------------|------------------|--------|---------|--------|---------|--------|
| | 25 | | 35 | | 50 | |
| | Size | Ripple | Size | Ripple | Size | Ripple |
| 2.2 | 16 x 25 | 6 | 16 x 25 | 6 | 16 x 25 | 6 |
| 3.3 | 16 x 25 | 7 | 16 x 25 | 7 | 16 x 25 | 7 |
| 4.7 | 16 x 25 | 7 | 16 x 25 | 7 | 16 x 25 | 7 |
| 5.6 | 16 x 32 | 7 | 16 x 32 | 7 | 16 x 32 | 7 |
| 6.8 | 16 x 36 | 8 | 16 x 36 | 8 | 16 x 36 | 8 |
| 8.2 | 16 x 36 | 8 | 16 x 36 | 8 | 16 x 36 | 8 |
| 10 | 18 x 40 | 12 | 18 x 40 | 12 | 18 x 40 | 12 |
| 13 | 18 x 40 | 12 | 18 x 40 | 12 | 18 x 40 | 12 |
| 15 | 18 x 40 | 12 | 18 x 40 | 12 | 18 x 40 | 12 |
| 18 | 22 x 40 | 13 | 22 x 40 | 13 | 22 x 40 | 13 |
| 20 | 22 x 40 | 13 | 22 x 40 | 13 | 22 x 40 | 13 |
| 22 | 22 x 40 | 13 | 22 x 40 | 13 | 22 x 40 | 13 |
| 25 | 22 x 40 | 13 | 22 x 40 | 13 | 22 x 40 | 13 |
| 47 | 22 x 40 | 13 | 22 x 40 | 13 | | |

Note : * 1. D x L : mm

* 2. mA rms at 105°C, 120Hz

Miniature Size Aluminum Electrolytic Capacitors

SN [For Non Polar]

105°C Single-Ended Lead Aluminum Electrolytic Capacitors For Non-Polar General Purpose



DESCRIPTION

Non-polar miniature type for used in reversing polarity DC voltage circuits.

Frequency coefficient

| | | | | | |
|---------------|------|------|------|------|----------|
| Frequency(Hz) | 60 | 120 | 300 | 1K | 10K~100K |
| Factor | 0.75 | 1.00 | 1.20 | 1.32 | 1.65 |

Temperature coefficient

| | | | |
|-----------------|------|------|------|
| Temperature(°C) | 65 | 85 | 105 |
| Factor | 1.30 | 1.20 | 1.00 |

DIAGRAM OF DIMENSIONS



ELECTRICAL CHARACTERISTICS

Operating Temperature : -40°C ~ +105°C

Working Voltage : 6.3 ~ 100V

Rate Capacitance Range : 0.47 ~ 2200μF

Capacitance Tolerance : -20 ~ +20%

DC Leakage Current (μA) : $I = 0.03 CV + 3\mu A$

(After 5 Minutes Application of DC Working Voltage at 25°C)

Dissipation Factor : at 120Hz, 25°C

| | | | | | | | |
|---------|-----|----|----|----|----|----|-----|
| WV (V) | 6.3 | 10 | 16 | 25 | 35 | 50 | 100 |
| D.F (%) | 24 | 20 | 17 | 15 | 14 | 12 | 10 |

For capacitor whose capacitance exceeds 1000μF. The value of D.F.(%) is increased by 2% for every addition of 1000μF.

Load Life : 1000 Hours at 105°C with the Polarity Inverted Every 250 Hours

- (a) Capacitance Change : Within 25% of Initial Value
- (b) Dissipation Factor : Not Exceed 150% of Initial Requirement
- (c) Leakage Current : Not Exceed the Initial Requirement

Shelf Life : 500 Hours, No Voltage Applied, at 105°C

- (a) Capacitance Change : Within 25% of Initial Value
- (b) Dissipation Factor : Not Exceed 200% of Initial Requirement
- (c) Leakage Current : Not Exceed 200% of Initial Requirement

Dimensions : mm

Rubber Stand-off



$L \leq 12$ $L + 1.5\text{Max.}$
 $13 \leq L \leq 15$ $L^{+1.0}_{-0.5}$
 $L \geq 16$ $L + 2.0\text{Max.}$

| Dø | F | dø |
|------|------|------|
| 4.0 | 1.5 | 0.45 |
| 5.0 | 2.0 | 0.5 |
| 6.0 | 2.5 | |
| 8.0 | 3.5 | |
| 10.0 | 5.0 | 0.6 |
| 12.0 | | |
| 13.0 | | |
| 16.0 | 7.5 | 0.8 |
| 18.0 | | |
| 22.0 | 10.0 | 0.8 |



CASE SIZE & PERMISSIBLE RIPPLE CURRENT OF STANDARD PRODUCTS

| CAP. (μF) | RATED VOLTAGE WV | | | | | | | | | | | | | | | | | |
|-----------|------------------|--------|-------|--------|-------|--------|-------|--------|-------|--------|-------|--------|-------|--------|-------|--------|-------|--------|
| | 6.3 | | 10 | | 16 | | 25 | | 35 | | 50 | | 63 | | 80 | | 100 | |
| | Size | Ripple | Size | Ripple | Size | Ripple | Size | Ripple | Size | Ripple | Size | Ripple | Size | Ripple | Size | Ripple | Size | Ripple |
| 0.22 | | | | | | | | | | | 5x11 | 5 | | | | | | |
| 0.47 | | | | | | | | | | | 5x11 | 5 | 5x11 | 11 | 5x11 | 11 | 5x11 | 14 |
| 1 | | | | | | | | | | | 5x11 | 17 | 5x11 | 17 | 5x11 | 17 | 5x11 | 21 |
| 2.2 | | | | | | | | | | | 5x11 | 25 | 5x11 | 25 | 5x11 | 29 | 6x11 | 34 |
| 3.3 | | | | | | | | | | | 6x11 | 31 | 6x11 | 37 | 6x11 | 39 | 8x11 | 49 |
| 4.7 | | | | | | | | | 5x11 | 34 | 5x11 | 34 | 5x11 | 37 | 8x11 | 47 | 8x11 | 58 |
| | | | | | | | | | | | 6x11 | 41 | 6x11 | 44 | | | | |
| 10 | | | | | 6x11 | 45 | 5x11 | 42 | 6x11 | 54 | 6x11 | 56 | 8x11 | 74 | 10x12 | 88 | 8x11 | 80 |
| | | | | | | | 6x11 | 50 | | | 8x11 | 70 | | | | | 10x12 | 100 |
| | | | 5x11 | 57 | 5x11 | 59 | 6x11 | 69 | 8x11 | 94 | 6x11 | 75 | 8x11 | 95 | 10x19 | 150 | 13x20 | 180 |
| 22 | | | | | 6x11 | 69 | 8x11 | 86 | | | 8x11 | 97 | 10x15 | 130 | | | | |
| | | | | | | | | | | | 10x12 | 115 | | | | | | |
| 33 | 5x11 | 63 | 6x11 | 77 | 8x11 | 98 | 8x11 | 105 | 10x12 | 125 | 8x11 | 110 | 8x11 | 115 | 13x20 | 205 | 13x20 | 220 |
| | | | | | | | | | | | 10x15 | 150 | 10x19 | 175 | | | | |
| 47 | 6x11 | 84 | 6x11 | 93 | 8x11 | 115 | 10x12 | 140 | 10x15 | 165 | 8x11 | 130 | 13x20 | 230 | 13x20 | 245 | 13x25 | 285 |
| | | | | | | | | | | | 10x19 | 190 | | | | | | |
| 100 | 8x11 | 140 | 8x11 | 193 | 8x11 | 140 | 10x19 | 240 | 13x20 | 285 | 13x20 | 310 | 16x25 | 410 | 16x25 | 435 | 16x32 | 510 |
| | | | | | 10x12 | 175 | | | | | | | | | | | | |
| | | | | | 10x15 | 205 | | | | | | | | | | | | |
| 220 | 10x12 | 235 | 10x15 | 255 | 10x19 | 330 | 13x20 | 390 | 16x25 | 520 | 16x25 | 570 | 16x32 | 660 | | | | |
| 330 | 10x15 | 310 | 10x19 | 380 | 13x20 | 445 | 16x25 | 580 | 16x25 | 630 | 16x36 | 790 | | | | | | |
| 470 | 10x19 | 400 | 13x20 | 470 | 13x25 | 570 | 16x25 | 690 | 16x32 | 820 | | | | | | | | |
| 1000 | 13x25 | 690 | 16x25 | 885 | 16x32 | 1020 | | | | | | | | | | | | |
| 2200 | 16x32 | 1250 | 16x36 | 1450 | | | | | | | | | | | | | | |

Note : * 1. D × L : mm

* 2. Ripple Current mA rms at 105°C, 120KHz

Miniature Size Aluminum Electrolytic Capacitors

SC [For Low Impedance and Low E.S.R
Suitable for Output of Mother Board]

105°C Single-Ended Lead Aluminum Electrolytic Capacitors For High Frequency Applications



DESCRIPTION

Used in switching regulator applications in computers. Especially for high frequency.

Low impedance and E.S.R., high permissible ripple current at high frequency and higher operating temperature (-40°C to +105°C).

High Temperature Load Life at 105°C for 3000 Hours

Multiplier for Ripple Current

Frequency coefficient

| Frequency(Hz) | 50 | 120 | 300 | 1K | 10K | 100K |
|---------------|------|------|------|------|------|------|
| ~4.7μF | 0.30 | 0.40 | 0.50 | 0.70 | 0.80 | 1.00 |
| 5.6~33μF | 0.40 | 0.50 | 0.60 | 0.80 | 0.90 | 1.00 |
| 34~330μF | 0.60 | 0.70 | 0.80 | 0.90 | 0.95 | 1.00 |
| 331~1000μF | 0.65 | 0.95 | 0.90 | 0.98 | 1.00 | 1.00 |
| 1200μF Higher | 0.85 | 0.90 | 0.95 | 0.98 | 1.00 | 1.00 |

Temperature coefficient

| Temperature(°C) | 65 | 85 | 105 |
|-----------------|------|------|------|
| Factor | 1.80 | 1.50 | 1.00 |

DIAGRAM OF DIMENSIONS



ELECTRICAL CHARACTERISTICS

Operating Temperature : -40° ~ +105°C

Working Voltage : 6.3 ~ 100V

Rate Capacitance Range : 4.7 ~ 15000μF

Capacitance Tolerance : -20 ~ +20%

DC Leakage Current (μA) : I = 0.01 CV(μA) or 3μA Whichever is greater.

(Measurements shall be Made After a 2 Minute Charge at Rated Working Voltage)

Dissipation Factor : at 120 Hz, 25°C

| | | | | | | | | | |
|-----------|-----|----|----|----|----|----|----|----|-----|
| WV (V) : | 6.3 | 10 | 16 | 25 | 35 | 50 | 63 | 80 | 100 |
| D.F (%) : | 15 | 14 | 12 | 10 | 10 | 8 | 8 | 7 | 7 |

For capacitor whose capacitance exceeds 1000μF. The value of D.F(%) is increased by 2% for every addition of 1000μF.

| | | | | | | | | |
|-------------------------------|-----|----|----|----|----|----|----|-----|
| WV (V) : | 6.3 | 10 | 16 | 25 | 35 | 50 | 63 | 100 |
| Impedance : Z -40°C / Z +20°C | 10 | 8 | 5 | 4 | 4 | 4 | 4 | 4 |

Load Life : 3000 Hours at 105°C Assured with Full Rated Maximum Ripple Current Applied

5 x 11 ~ 10 x 12 : Life = 2000 Hours

10 x 15 or Higher : Life = 3000 Hours

(a) Capacitance Change : Within 20% of Initial Value

(b) Dissipation Factor : Not Exceed 200% of Initial Requirement

(c) Leakage Current : Not Exceed the Initial Requirement

Shelf Life : 1000 Hours, No Voltage Applied, at 105°C

(a) Capacitance Change : Within 20% of Initial Value

(b) Dissipation Factor : Not Exceed 200 % of Initial Requirement

(c) Leakage Current : Not Exceed 200% of Initial Requirement

Dimensions : mm

Rubber Stand-off



L ≤ 12 L + 1.5Max.
13 ≤ L ≤ 15 L +1.0
L -0.5
L ≥ 16 L + 2.0Max.

| Dø | F | dø |
|------|------|------|
| 4.0 | 1.5 | 0.45 |
| 5.0 | 2.0 | 0.5 |
| 6.0 | 2.5 | |
| 8.0 | 3.5 | |
| 10.0 | 5.0 | 0.6 |
| 12.0 | | |
| 13.0 | | |
| 16.0 | 7.5 | 0.8 |
| 18.0 | | |
| 22.0 | 10.0 | 0.8 |



CASE SIZE OF STANDARD PRODUCTS $D\phi \geq 6\text{mm}$ with Safety Vent at Can Bottom

| CAP. (μF) | RATED VOLTAGE WV | | | | | | | | | | | |
|------------------------|------------------|---------------|-------|----------|--------------|-------|----------|--------------|-------|----------|--------------|-------|
| | Size | 6.3 Ripple | ESR | Size | 10 Ripple | ESR | Size | 16 Ripple | ESR | Size | 25 Ripple | ESR |
| 4.7 | | | | | | | | | | | | |
| 6.8 | | | | | | | | | | | | |
| 10 | | | | | | | | | | *4 × 7 | 40 | 2.000 |
| | | | | | | | | | | 5 × 11 | 50 | 0.550 |
| 22 | | | | | | | | | | | | |
| 33 | | | | | | | | | | | | |
| 47 | | | | | | | | | | 5 × 11 | 150 | 0.420 |
| 56 | | | | | | | | | | | | |
| 68 | | | | | | | 5 × 11 | 150 | 0.420 | 6 × 11 | 200 | 0.370 |
| 100 | | | | 5 × 11 | 150 | 0.420 | 5 × 11 | 200 | 0.370 | 6 × 11 | 250 | 0.220 |
| 120 | | | | 5 × 11 | 200 | 0.370 | 6 × 11 | 250 | 0.320 | 8 × 11 | 300 | 0.200 |
| 150 | 5 × 11 | 200 | 0.420 | 6 × 11 | 250 | 0.320 | 6 × 11 | 300 | 0.220 | 8 × 11 | 550 | 0.140 |
| 220 | 6 × 11 | 250 | 0.320 | 6 × 11 | 300 | 0.220 | 8 × 11 | 550 | 0.140 | *8 × 11 | 620 | 0.120 |
| | | | | | | | | | | 8 × 15 | 750 | 0.100 |
| 270 | *6 × 11 | 300 | 0.220 | | | | | | | | | |
| | *6 × 11 | 320 | 0.230 | 8 × 11 | 550 | 0.140 | *8 × 11 | 620 | 0.120 | *8 × 15 | 660 | 0.100 |
| 330 | 8 × 11 | 400 | 0.180 | | | | 8 × 15 | 750 | 0.100 | 8 × 20 | 800 | 0.069 |
| | | | | | | | | | | 10 × 15 | 900 | 0.086 |
| | *6 × 11 | 440 | 0.160 | *8 × 11 | 620 | 0.120 | *8 × 15 | 730 | 0.093 | *8 × 20 | 1000 | 0.067 |
| 470 | 8 × 11 | 550 | 0.140 | 8 × 15 | 750 | 0.100 | 10 × 12 | 800 | 0.085 | *10 × 12 | 900 | 0.086 |
| | | | | | | | | | | 10 × 15 | 1050 | 0.064 |
| 680 | *8 × 11 | 580 | 0.120 | *8 × 11 | 640 | 0.110 | 10 × 15 | 1050 | 0.064 | 10 × 19 | 1100 | 0.039 |
| | 8 × 15 | 700 | 0.100 | 10 × 12 | 800 | 0.085 | | | | | | |
| 820 | 8 × 20 | 750 | 0.085 | 10 × 15 | 1050 | 0.064 | 10 × 19 | 1100 | 0.044 | 10 × 19 | 1250 | 0.039 |
| | *8 × 11 | 580 | 0.150 | 8 × 20 | 1080 | 0.065 | *10 × 15 | 1140 | 0.043 | *10 × 19 | 1160 | 0.047 |
| 1000 | *8 × 15 | 670 | 0.069 | 10 × 12 | 930 | 0.075 | 10 × 19 | 1250 | 0.039 | *10 × 25 | 1310 | 0.042 |
| | 8 × 20 | 800 | 0.069 | 10 × 15 | 990 | 0.085 | | | | 13 × 20 | 1450 | 0.038 |
| | 10 × 12 | 690 | 0.080 | 10 × 19 | 1100 | 0.050 | | | | | | |
| 1200 | 10 × 15 | 1000 | 0.064 | 10 × 19 | 1250 | 0.044 | *10 × 25 | 1310 | 0.042 | | | |
| | | | | | | | 13 × 20 | 1450 | 0.038 | | | |
| | *8 × 15 | 980 | 0.085 | 10 × 9 | 1450 | 0.039 | *10 × 19 | 1200 | 0.045 | *12 × 30 | 1750 | 0.032 |
| 1500 | *8 × 20 | 1070 | 0.051 | | | | 13 × 20 | 1600 | 0.034 | 16 × 25 | 2000 | 0.028 |
| | *10 × 15 | 1070 | 0.055 | | | | | | | | | |
| | 10 × 19 | 1250 | 0.044 | | | | | | | | | |
| | *10 × 19 | 1220 | 0.051 | *10 × 19 | 1330 | 0.047 | *10 × 30 | 1780 | 0.032 | *13 × 30 | 1810 | 0.029 |
| 2200 | *10 × 25 | 1310 | 0.048 | *10 × 25 | 1450 | 0.025 | *13 × 20 | 1720 | 0.033 | *16 × 25 | 1660 | 0.032 |
| | 13 × 20 | 1450 | 0.043 | 13 × 20 | 1600 | 0.038 | 13 × 25 | 2000 | 0.028 | 16 × 32 | 2200 | 0.024 |
| | *10 × 25 | 1400 | 0.043 | *10 × 30 | 1740 | 0.032 | *13 × 40 | 2200 | 0.026 | 16 × 36 | 2550 | 0.019 |
| 3300 | 13 × 25 | 1700 | 0.035 | 13 × 25 | 2000 | 0.028 | 16 × 25 | 2200 | 0.024 | | | |
| 3900 | 13 × 25 | 1750 | 0.032 | | | | | | | | | |
| | *12 × 30 | 1570 | 0.033 | *13 × 25 | 1860 | 0.028 | 16 × 6 | 2550 | 0.019 | 18 × 36 | 2800 | 0.019 |
| 4700 | *13 × 25 | 1570 | 0.032 | 16 × 25 | 2200 | 0.024 | | | | | | |
| | 16 × 25 | 1800 | 0.028 | | | | | | | | | |
| 6800 | 16 × 32 | 2000 | 0.024 | 16 × 36 | 2550 | 0.019 | 18 × 36 | 2800 | 0.019 | 18 × 36 | 2800 | 0.019 |
| 8200 | 16 × 32 | 2350 | 0.019 | 18 × 36 | 2800 | 0.019 | | | | | | |
| 10000 | 16 × 36 | 2550 | 0.019 | | | | | | | | | |
| 15000 | 18 × 36 | 3000 | 0.019 | | | | | | | | | |

Note : * 1. D × L : mm

*2. Ripple Current :(mA r.m.s 105°C / 100KHz), ESR (Ω Max20°C/100KHz)

3. "" is down size, Edurance is less 1000 hrs than standard



CASE SIZE OF STANDARD PRODUCTS $D\phi \geq 6\text{mm}$ with Safety Vent at Can Bottom

| CAP. (μF) | RATED VOLTAGE WV | | | | | | | | | | | |
|------------------------|------------------|--------------|-------|----------|--------------|-------|---------|--------------|-------|---------|---------------|-------|
| | Size | 35 Ripple | ESR | Size | 50 Ripple | ESR | Size | 63 Ripple | ESR | Size | 100 Ripple | ESR |
| 4.7 | 5 x 11 | 115 | 1.200 | 5 x 11 | 115 | 2.000 | 5 x 11 | 115 | 2.200 | 5 x 11 | 120 | 2.000 |
| 6.8 | 5 x 11 | 120 | 1.000 | 5 x 11 | 120 | 1.850 | 5 x 11 | 200 | 2.000 | 5 x 11 | 140 | 1.850 |
| 10 | 5 x 11 | 140 | 0.900 | 5 x 11 | 140 | 1.700 | 5 x 11 | 140 | 1.850 | 6 x 11 | 200 | 1.500 |
| 15 | 5 x 11 | 170 | 0.690 | 5 x 11 | 180 | 1.200 | 5 x 11 | 200 | 1.700 | 6 x 11 | 250 | 1.200 |
| 22 | 5 x 11 | 190 | 0.420 | 5 x 11 | 200 | 0.700 | 6 x 11 | 250 | 1.200 | 8 x 11 | 300 | 0.790 |
| 33 | 5 x 11 | 200 | 0.420 | 6 x 11 | 250 | 0.600 | 6 x 11 | 300 | 0.900 | 8 x 15 | 450 | 0.590 |
| 47 | 6 x 11 | 250 | 0.370 | 6 x 11 | 300 | 0.520 | 8 x 11 | 450 | 0.700 | 10 x 15 | 550 | 0.350 |
| 68 | 6 x 11 | 300 | 0.220 | 8 x 11 | 450 | 0.350 | 8 x 11 | 550 | 0.520 | 10 x 9 | 650 | 0.240 |
| 100 | *6 x 11 | 360 | 0.180 | *8 x 11 | 480 | 0.290 | 8 x 20 | 650 | 0.350 | 13 x 20 | 800 | 0.180 |
| | 8 x 11 | 450 | 0.140 | 8 x 15 | 550 | 0.250 | | | | | | |
| 120 | 8 x 11 | 550 | 0.130 | 8 x 20 | 650 | 0.210 | 10 x 15 | 800 | 0.300 | 13 x 25 | 1050 | 0.150 |
| 150 | 8 x 15 | 650 | 0.100 | 10 x 12 | 800 | 0.160 | 10 x 15 | 1050 | 0.200 | 13 x 5 | 1300 | 0.110 |
| 220 | *8 x 15 | 730 | 0.075 | 10 x 15 | 1050 | 0.100 | 10 x 19 | 1300 | 0.150 | 16 x 25 | 1400 | 0.071 |
| | 10 x 12 | 800 | 0.069 | | | | | | | | | |
| 330 | *10 x 15 | 900 | 0.052 | 10 x 9 | 1300 | 0.072 | 13 x 0 | 1400 | 0.100 | 16 x 2 | 1550 | 0.049 |
| | 10 x 19 | 1050 | 0.044 | | | | | | | | | |
| 470 | 10 x 19 | 1300 | 0.039 | *10 x 19 | 1390 | 0.075 | 13 x 25 | 1550 | 0.064 | 18 x 36 | 1700 | 0.038 |
| | | | | 13 x 20 | 1400 | 0.060 | | | | | | |
| 680 | 13 x 20 | 1400 | 0.038 | 13 x 25 | 1550 | 0.050 | 16 x 25 | 1700 | 0.052 | | | |
| 820 | 13 x 20 | 1550 | 0.034 | 16 x 25 | 1700 | 0.040 | 16 x 32 | 1900 | 0.048 | | | |
| 1000 | 13 x 25 | 1700 | 0.029 | 16 x 25 | 1900 | 0.039 | 16 x 32 | 2100 | 0.042 | | | |
| 1200 | 16 x 25 | 1900 | 0.028 | 16 x 32 | 2100 | 0.025 | 16 x 36 | 2550 | 0.036 | | | |
| 1500 | 16 x 25 | 2100 | 0.024 | 16 x 36 | 2550 | 0.025 | 18 x 36 | 2800 | 0.033 | | | |
| 2200 | *16 x 32 | 2300 | 0.021 | 18 x 40 | 2800 | 0.025 | | | | | | |
| | 16 x 36 | 2550 | 0.019 | | | | | | | | | |
| 3300 | 18 x 36 | 2880 | 0.019 | | | | | | | | | |
| 3900 | | | | | | | | | | | | |
| 4700 | | | | | | | | | | | | |
| 6800 | | | | | | | | | | | | |
| 8200 | | | | | | | | | | | | |
| 10000 | | | | | | | | | | | | |
| 15000 | | | | | | | | | | | | |

Note : * 1. D x L : mm

*2. Ripple Current : (mA r.m.s 105°C / 100KHz), ESR (Ω Max20°C / 100KHz)

3. "" is down size, Edurance is less 1000 hrs than standard

Miniature Size Aluminum Electrolytic Capacitors

SM [For Very Low Impedance and Very Low E.S.R Suitable for Output of Mother Board]

105°C Single-Ended Lead Aluminum Electrolytic Capacitors For High Frequency Applications

ELECTRICAL CHARACTERISTICS

Operating Temperature : -40° ~ +105°C

Working Voltage : 6.3 ~ 25V

Rate Capacitance Range : 470 ~ 4700μF

Capacitance Tolerance : -20 ~ +20%

DC Leakage Current (μA) : I = 0.01 CV(μA)

(Measurements shall be Made After a 2 Minute Charge at Rated Working Voltage)

Dissipation Factor : at 120 Hz, 25°C

WV (V) : $\frac{6.3}{15}$ - $\frac{10}{14}$ - $\frac{16}{12}$ -

For capacitor whose capacitance exceeds 1000μF. The value of D.F(%) is increased by 2% for every addition of 1000μF.

Load Life : 2000 Hours for D = 8ø; 3000 Hours for D ≥ 10ø at 105°C

- (a) Capacitance Change : Within 20% of Initial Value
- (b) Dissipation Factor : Not Exceed 200% of Initial Requirement
- (c) Leakage Current : Not Exceed the Initial Requirement

Shelf Life : 1000 Hours, No Voltage Applied, at 105°C

- (a) Capacitance Change : Within 20% of Initial Value
- (b) Dissipation Factor : Not Exceed 200 % of Initial Requirement
- (c) Leakage Current : Not Exceed 200% of Initial Requirement

DIAGRAM OF DIMENSIONS

| Dø | F | dø |
|------|------|------|
| 4.0 | 1.5 | 0.45 |
| 5.0 | 2.0 | 0.5 |
| 6.0 | 2.5 | |
| 8.0 | 3.5 | |
| 10.0 | 5.0 | 0.6 |
| 12.0 | | |
| 13.0 | | |
| 16.0 | 7.5 | 0.8 |
| 18.0 | | |
| 22.0 | 10.0 | 0.8 |

Rubber Stand-off



L ≤ 12 L + 1.5Max.
 13 ≤ L ≤ 15 L +1.0
 L -0.5
 L ≥ 16 L + 2.0Max.

DESCRIPTION



Used in switching regulator applications in computers. Especially for high frequency.

Very low impedance and E.S.R., high permissible ripple current at high frequency and higher operating temperature (-40°C to +105°C).

High Temperature Load Life at 105°C for 3000 Hours

Multiplier for Ripple Current

Frequency coefficient

| Frequency(Hz) | 60 | 120 | 1K | 10K | 100K |
|---------------|------|------|------|------|------|
| 5.6~33μF | 0.45 | 0.55 | 0.75 | 0.90 | 1.00 |
| 39~330μF | 0.6 | 0.70 | 0.85 | 0.95 | 1.00 |
| 470~1000μF | 0.65 | 0.75 | 0.90 | 0.98 | 1.00 |
| 1200~6800μF | 0.75 | 0.80 | 0.95 | 1.00 | 1.00 |

Temperature coefficient

| Temperature(°C) | 65 | 85 | 105 |
|-----------------|------|------|------|
| Factor | 2.00 | 1.60 | 1.00 |

Dimensions : mm





CASE SIZE OF STANDARD PRODUCTS $D\phi \geq 6\text{mm}$ with Safety Vent at Can Bottom

| CAP. (μF) | RATED VOLTAGE | | | | | | | | |
|------------------------|---------------|---------------|-------|----------|--------------|-------|----------|--------------|-------|
| | SIZE | 6.3 Ripple | ESR | SIZE | 10 Ripple | ESR | SIZE | 16 Ripple | ESR |
| 330 | | | | | | | *8 x 11 | | 0.066 |
| 470 | 8 x 11 | 582 | 0.100 | 8 x 11 | 760 | 0.072 | 8 x 15 | 995 | 0.056 |
| | | | | | | | 10 x 12 | 1030 | 0.053 |
| 680 | | | | 8 x 11 | 760 | 0.056 | 8 x 20 | 1250 | 0.041 |
| | | | | 8 x 15 | 995 | 0.067 | 10 x 15 | 1430 | 0.038 |
| 1000 | 8 x 15 | 950 | 0.053 | 8 x 20 | 1250 | 0.041 | 10 x 19 | 1820 | 0.023 |
| | | | | 10 x 15 | 1430 | 0.038 | | | |
| | 8 x 20 | 1250 | 0.041 | 10 x 19 | 1820 | 0.023 | *10 x 19 | 1900 | 0.023 |
| 1200 | 10 x 12 | 1240 | 0.044 | | | | 10 x 22 | 2150 | 0.022 |
| | 10 x 15 | 1430 | 0.038 | | | | | | |
| 1500 | 10 x 19 | 1820 | 0.023 | *10 x 22 | 1920 | 0.025 | 13 x 20 | 2360 | 0.028 |
| | | | | 10 x 25 | 2150 | 0.022 | | | |
| 2200 | 10 x 22 | 2150 | 0.023 | 13 x 20 | 2360 | 0.021 | 13 x 25 | 2770 | 0.025 |
| 2700 | 10 x 25 | 2200 | 0.022 | | | | 13 x 30 | 3290 | 0.023 |
| 3300 | *10 x 25 | 2200 | 0.024 | 13 x 25 | 2770 | 0.018 | | | |
| | 13 x 20 | 2360 | 0.021 | | | | | | |
| 3900 | | | | 13 x 30 | 3290 | 0.016 | | | |
| 4700 | 13 x 30 | 3290 | 0.016 | | | | | | |

Note : * I. D x L : mm

*2. Ripple Current :(mA r.m.s 105°C / 100KHz), ESR (Ω Max20°C / 100KHz)

3. "" is down size, Edurance is less 1000 hrs than standard



CASE SIZE OF STANDARD PRODUCTS $D\phi \geq 6\text{mm}$ with Safety Vent at Can Bottom

CAP. (μF) RATED VOLTAGE

| | 25 | | | 35 | | |
|------|----------|--------|-------|---------|--------|-------|
| | SIZE | Ripple | ESR | SIZE | Ripple | ESR |
| 220 | 8 x 11 | 760 | 0.072 | 8 x 15 | 995 | 0.056 |
| | | | | 10 x 12 | 1030 | 0.053 |
| 270 | *8 x 15 | | 0.057 | 8 x 20 | 1250 | 0.041 |
| 330 | 10 x 12 | 1030 | 0.053 | 10 x 15 | 1430 | 0.038 |
| 470 | 8 x 20 | 1250 | 0.041 | 10 x 19 | 1820 | 0.023 |
| | 10 x 15 | 1430 | 0.038 | | | |
| 680 | 10 x 19 | 1820 | 0.028 | 13 x 20 | 2360 | 0.021 |
| 820 | 10 x 22 | 2150 | 0.024 | | | |
| | 10 x 25 | 2200 | 0.021 | | | |
| | *10 x 30 | 2200 | 0.024 | 13 x 25 | 2770 | 0.025 |
| 1000 | 12 x 20 | 2360 | 0.025 | | | |
| | 13 x 25 | | 0.021 | | | |
| 1200 | | | | 13 x 30 | 3290 | 0.016 |
| 1500 | 13 x 30 | 2700 | 0.029 | | | |
| 2200 | | | | | | |
| 2700 | | | | | | |
| 3300 | | | | | | |
| 3900 | | | | | | |
| 4700 | | | | | | |

Note : * 1. D x L : mm

*2. Ripple Current :(mA r.m.s 105°C / 100KHz), ESR (Ω Max20°C / 100KHz)

3. "" is down size, Edurance is less 1000 hrs than standard

SX [For Low Impedance & Low E.S.R]

105°C Single-Ended Lead Aluminum Electrolytic Capacitors For High Frequency Applications

Miniature Size Aluminum Electrolytic Capacitors

ELECTRICAL CHARACTERISTICS

Operating Temperature : -40° ~ +105°C

Working Voltage : 6.3 ~ 100V

Rate Capacitance Range : 22 ~ 15000μF

Capacitance Tolerance : -20 ~ +20%

DC Leakage Current (μA) : I = 0.01 CV or 3(μA) Whichever is greater.

(Measurements shall be Made After a 2 Minute Charge at Rated Working Voltage)

Dissipation Factor : at 120 Hz, 25°C

| | | | | | | | | | |
|-----------|-----|----|----|----|----|----|----|----|-----|
| WV (V) : | 6.3 | 10 | 16 | 25 | 35 | 50 | 63 | 80 | 100 |
| D.F (%) : | 19 | 16 | 14 | 12 | 10 | 8 | 8 | 7 | 7 |

For capacitor whose capacitance exceeds 1000μF. The value of D.F(%) is increased by 2% for every addition of 1000μF.

Temperature Characteristics : at 120 Hz

| | | | | | | | | |
|-------------------------------|-----|----|----|----|----|----|----|-----|
| WV (V) : | 6.3 | 10 | 16 | 25 | 35 | 50 | 63 | 100 |
| Impedance : Z -40°C / Z +20°C | 10 | 6 | 5 | 4 | 4 | 4 | 4 | 4 |

Load Life : At 105°C Assured with Full Rated Maximum Ripple Current Applied

| | | | |
|----------|--------|---------|---------|
| Case Dia | øD ≤ 8 | øD = 10 | øD ≥ 12 |
|----------|--------|---------|---------|

| | | | |
|-----------|------|------|------|
| Load Life | 2000 | 3000 | 5000 |
|-----------|------|------|------|

- (a) Capacitance Change : Within 20% of Initial Value
- (b) Dissipation Factor : Not Exceed 200% of Initial Requirement
- (c) Leakage Current : Not Exceed the Initial Requirement

Shelf Life : 1000 Hours, No Voltage Applied, at 105°C

- (a) Capacitance Change : Within 20% of Initial Value
- (b) Dissipation Factor : Not Exceed 200 % of Initial Requirement
- (c) Leakage Current : Not Exceed 200% of Initial Requirement

DIAGRAM OF DIMENSIONS

| Dø | F | dø |
|------|------|------|
| 4.0 | 1.5 | 0.45 |
| 5.0 | 2.0 | 0.5 |
| 6.0 | 2.5 | |
| 8.0 | 3.5 | |
| 10.0 | 5.0 | 0.6 |
| 12.0 | | |
| 13.0 | | |
| 16.0 | 7.5 | 0.8 |
| 18.0 | | |
| 22.0 | 10.0 | 0.8 |

Rubber Stand-off

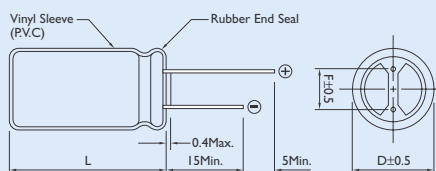

L ≤ 12 L + 1.5Max.
 13 ≤ L ≤ 15 L + 1.0Max.
 L ≥ 16 L + 2.0Max.

DESCRIPTION

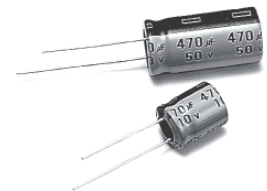

Used in switching regulator applications in computers. Especially for high frequency.

Low impedance and E.S.R., high permissible ripple current at high frequency and higher operation temperature (-40°C to +105°C).

High Temperature Load Life at 105°C for 2000 ~ 5000 Hours

Multiplier for Ripple Current

Frequency coefficient

| Frequency(Hz) | 50 | 120 | 300 | 1K | 10K | 100K |
|---------------|------|------|------|------|------|------|
| ~4.4μF | 0.30 | 0.40 | 0.50 | 0.70 | 0.80 | 1.00 |
| 5.6~33μF | 0.40 | 0.50 | 0.60 | 0.80 | 0.90 | 1.00 |
| 34~330μF | 0.60 | 0.70 | 0.80 | 0.90 | 0.95 | 1.00 |
| 331~1000μF | 0.65 | 0.90 | 0.90 | 0.98 | 1.00 | 1.00 |
| 1200μF higher | 0.85 | 0.90 | 0.95 | 0.98 | 1.00 | 1.00 |

Temperature coefficient

| Temperature(°C) | 65 | 85 | 105 |
|-----------------|------|------|------|
| Factor | 1.80 | 1.50 | 1.00 |

Dimensions : mm



CASE SIZE OF STANDARD PRODUCTS $D\varnothing \geq 6\text{mm}$ with Safety Vent at Can Bottom

| CAP. (μF) | RATED VOLTAGE | | | | | | | | |
|------------------------|---------------|---------------|-------|---------|--------------|-------|---------|--------------|-------|
| | SIZE | 6.3 Ripple | ESR | SIZE | 10 Ripple | ESR | SIZE | 16 Ripple | ESR |
| 4.7 | | | | | | | | | |
| 6.8 | | | | | | | | | |
| 10 | | | | 5 × 11 | 20 | 5.900 | | | |
| | | | | | | | 5 × 11 | 42 | 1.180 |
| 22 | | | | 5 × 11 | 44 | 5.400 | 5 × 11 | 53 | 3.300 |
| 33 | | | | 5 × 11 | 66 | 3.300 | 5 × 11 | 79 | 2.100 |
| 47 | | | | 5 × 11 | 94 | 2.200 | 5 × 11 | 113 | 1.300 |
| 68 | | | | 5 × 11 | 136 | 1.300 | 5 × 11 | 145 | 0.920 |
| | | | | | | | 6 × 11 | 163 | 0.920 |
| 100 | 5 × 11 | 166 | 1.500 | 5 × 11 | 170 | 1.150 | 6 × 11 | 190 | 1.100 |
| | | | | 6 × 11 | 200 | 1.150 | 8 × 11 | 241 | 0.890 |
| 120 | 5 × 11 | 175 | 1.300 | 6 × 11 | 240 | 0.910 | 8 × 11 | 290 | 0.580 |
| 150 | 6 × 11 | 225 | 0.920 | 6 × 11 | 265 | 0.700 | 8 × 11 | 380 | 0.470 |
| 220 | 8 × 11 | 285 | 0.610 | 6 × 11 | 290 | 0.590 | 8 × 11 | 410 | 0.330 |
| | | | | 8 × 11 | 370 | 0.480 | | | |
| 330 | 8 × 11 | 410 | 0.400 | 8 × 11 | 470 | 0.330 | 10 × 12 | 600 | 0.230 |
| 470 | 10 × 12 | 550 | 0.280 | 8 × 11 | 480 | 0.300 | 8 × 20 | 710 | 0.180 |
| | | | | 10 × 12 | 590 | 0.240 | 10 × 15 | 750 | 0.180 |
| 680 | 10 × 15 | 735 | 0.220 | 8 × 20 | 790 | 0.180 | 10 × 19 | 1050 | 0.140 |
| | | | | 10 × 15 | 750 | 0.170 | | | |
| 820 | 10 × 15 | 795 | 0.190 | 10 × 19 | 990 | 0.140 | 10 × 25 | 1220 | 0.120 |
| 1000 | 10 × 19 | 950 | 0.170 | 10 × 15 | 900 | 0.135 | 10 × 30 | 1400 | 0.091 |
| | | | | 10 × 19 | 1060 | 0.120 | | | |
| 1200 | 10 × 19 | 1020 | 0.140 | 10 × 25 | 1290 | 0.120 | 10 × 25 | 1240 | 0.100 |
| | | | | | | | 12 × 25 | 1450 | 0.086 |
| 1500 | 10 × 19 | 1000 | 0.140 | 10 × 30 | 1450 | 0.093 | 12 × 25 | 1650 | 0.072 |
| | 10 × 25 | 1200 | 0.120 | | | | | | |
| 2200 | 10 × 30 | 1450 | 0.095 | 12 × 30 | 1570 | 0.087 | 12 × 30 | 1820 | 0.069 |
| | | | | 13 × 20 | 1900 | 0.073 | 13 × 25 | 2000 | 0.063 |
| 3300 | 12 × 35 | 1700 | 0.081 | 10 × 30 | 1690 | 0.077 | 13 × 40 | 2400 | 0.055 |
| | | | | 12 × 35 | 2110 | 0.062 | | | |
| 4700 | 12 × 35 | 2110 | 0.063 | 13 × 40 | 2300 | 0.057 | 16 × 6 | 2650 | 0.046 |
| | | | | 16 × 32 | 2450 | 0.054 | | | |
| 6800 | 16 × 32 | 2350 | 0.055 | 16 × 36 | 2680 | 0.046 | 18 × 36 | 2900 | 0.040 |
| 8200 | 16 × 36 | 2550 | 0.047 | 16 × 40 | 2850 | 0.038 | 18 × 40 | 3050 | 0.036 |
| 10000 | 16 × 40 | 2750 | 0.039 | 16 × 40 | 3050 | 0.037 | | | |
| 15000 | 18 × 40 | 2950 | 0.037 | | | | | | |

Note : * 1. D × L : mm

*2. Ripple Current : (mA r.m.s 105°C / 100kHz)

*3. ESR (Ω Max20°C / 100kHz)



CASE SIZE OF STANDARD PRODUCTS $D\varnothing \geq 6\text{mm}$ with Safety Vent at Can Bottom

| CAP. (μF) | RATED VOLTAGE | | | | | | | | |
|-----------|---------------|--------------|-------|---------|--------------|-------|---------|--------------|-------|
| | SIZE | 25 Ripple | ESR | SIZE | 35 Ripple | ESR | SIZE | 50 Ripple | ESR |
| 4.7 | | | | | | | | | |
| 6.8 | | | | | | | 5 × 11 | 39 | 3.100 |
| 10 | | | | 5 × 11 | 42 | 3.100 | 5 × 1 | 58 | 2.000 |
| 22 | 5 × 11 | 66 | 3.300 | 5 × 11 | 101 | 1.300 | 6 × 11 | 129 | 0.900 |
| 33 | 5 × 11 | 99 | 1.300 | 6 × 11 | 151 | 0.870 | 8 × 11 | 194 | 0.720 |
| 47 | 5 × 1 | 141 | 1.100 | 8 × 11 | 216 | 0.870 | 8 × 11 | 276 | 0.660 |
| 68 | 8 × 11 | 204 | 0.570 | 8 × 11 | 312 | 0.370 | 10 × 12 | 400 | 0.310 |
| 100 | 6 × 11 | 240 | 0.530 | 8 × 11 | 370 | 0.390 | 8 × 15 | 530 | 0.240 |
| | 8 × 11 | 300 | 0.420 | 10 × 12 | 460 | 0.320 | 10 × 15 | 635 | 0.200 |
| 120 | 8 × 11 | 400 | 0.380 | 10 × 12 | 550 | 0.260 | 10 × 15 | 670 | 0.170 |
| 150 | 10 × 12 | 460 | 0.330 | 10 × 12 | 600 | 0.230 | 10 × 19 | 860 | 0.150 |
| 220 | 10 × 15 | 630 | 0.230 | 10 × 12 | 690 | 0.210 | 10 × 15 | 780 | 0.150 |
| | | | | 10 × 15 | 800 | 0.180 | 10 × 25 | 1030 | 0.110 |
| 330 | 10 × 12 | 690 | 0.220 | 10 × 19 | 1060 | 0.130 | 10 × 30 | 1070 | 0.110 |
| | 10 × 15 | 800 | 0.190 | | | | 12 × 20 | 1220 | 0.092 |
| 470 | | | | | | | 13 × 25 | 1300 | 0.086 |
| | 10 × 15 | 890 | 0.165 | 10 × 30 | 990 | 0.089 | 12 × 25 | 1500 | 0.068 |
| 560 | 10 × 19 | 1050 | 0.140 | 13 × 25 | 1060 | 0.086 | | | |
| | 12 × 16 | 1200 | 0.120 | 12 × 20 | 1500 | 0.080 | | | |
| 680 | 10 × 30 | 1400 | 0.090 | 12 × 25 | 1650 | 0.070 | 12 × 35 | 1850 | 0.058 |
| 820 | 12 × 25 | 1450 | 0.085 | 12 × 30 | 1750 | 0.066 | 12 × 40 | 2020 | 0.052 |
| 1000 | 12 × 20 | 1420 | 0.091 | 12 × 30 | 2000 | 0.061 | 16 × 25 | 1800 | 0.060 |
| | 12 × 25 | 1650 | 0.078 | | | | 16 × 32 | 2120 | 0.050 |
| 1200 | 12 × 30 | 1700 | 0.070 | 12 × 35 | 2200 | 0.049 | 16 × 36 | 2260 | 0.043 |
| 1500 | 12 × 30 | 1950 | 0.062 | 12 × 40 | 2350 | 0.046 | 16 × 40 | 2420 | 0.035 |
| 2200 | 12 × 40 | 2360 | 0.054 | 16 × 36 | 2700 | 0.044 | | | |
| 3300 | 16 × 36 | 2700 | 0.045 | 18 × 40 | 3050 | 0.035 | | | |
| 3900 | | | | | | | | | |
| 4700 | 18 × 40 | 3000 | 0.036 | | | | | | |
| 6800 | | | | | | | | | |
| 8200 | | | | | | | | | |
| 10000 | | | | | | | | | |
| 15000 | | | | | | | | | |

Note : * 1. D × L : mm

*2. Ripple Current : (mA r.m.s 105°C / 100KHz)

*3. ESR (Ω Max20°C / 100KHz)



CASE SIZE OF STANDARD PRODUCTS $D\varnothing \geq 6\text{mm}$ with Safety Vent at Can Bottom

| CAP. (μF) | RATED VOLTAGE | | | | | | | | |
|------------------------|---------------|--------------|-------|---------|--------------|-------|---------|---------------|-------|
| | SIZE | 63 Ripple | ESR | SIZE | 80 Ripple | ESR | SIZE | 100 Ripple | ESR |
| 4.7 | 5 x 11 | 36 | 4.600 | 5 x 11 | 43 | 4.200 | 5 x 11 | 65 | 4.100 |
| 6.8 | 5 x 11 | 52 | 4.300 | 5 x 11 | 62 | 1.900 | 8 x 11 | 94 | 1.300 |
| 10 | 5 x 11 | 77 | 2.000 | 6 x 11 | 92 | 1.400 | 8 x 11 | 138 | 1.100 |
| 15 | 6 x 11 | 116 | 1.400 | 8 x 11 | 138 | 1.100 | 8 x 11 | 207 | 0.800 |
| 22 | 8 x 11 | 170 | 1.200 | 8 x 11 | 203 | 0.640 | 10 x 12 | 305 | 0.530 |
| 33 | 8 x 11 | 256 | 0.660 | 10 x 12 | 305 | 0.540 | 10 x 15 | 500 | 0.350 |
| 47 | 10 x 12 | 365 | 0.560 | 10 x 15 | 410 | 0.360 | 10 x 19 | 600 | 0.300 |
| 68 | 10 x 15 | 500 | 0.360 | 10 x 19 | 600 | 0.260 | 10 x 25 | 795 | 0.190 |
| 100 | 10 x 15 | 750 | 0.310 | 10 x 25 | 795 | 0.190 | 10 x 30 | 870 | 0.170 |
| | | | | | | | 13 x 20 | 955 | 0.150 |
| 120 | 10 x 19 | 820 | 0.270 | 10 x 30 | 900 | 0.170 | 12 x 30 | 1040 | 0.130 |
| 150 | 10 x 25 | 950 | 0.200 | 10 x 30 | 955 | 0.150 | 12 x 30 | 1200 | 0.110 |
| 180 | | | | | | | 13 x 25 | 1300 | 0.100 |
| 220 | 12 x 25 | 1150 | 0.160 | 12 x 30 | 1200 | 0.130 | 16 x 32 | 1440 | 0.086 |
| 330 | 12 x 30 | 1360 | 0.140 | 12 x 35 | 1450 | 0.088 | 16 x 32 | 1610 | 0.070 |
| | 13 x 25 | 1420 | 0.130 | | | | 16 x 36 | 1790 | 0.062 |
| 470 | 12 x 35 | 1780 | 0.091 | 16 x 32 | 1790 | 0.063 | 16 x 40 | 2160 | 0.048 |
| | | | | | | | 18 x 36 | 2200 | 0.047 |
| 560 | | | | | | | | | |
| 680 | 16 x 32 | 2050 | 0.065 | 16 x 40 | 1990 | 0.058 | | | |
| 820 | 16 x 36 | 2200 | 0.056 | 18 x 36 | 2200 | 0.050 | | | |
| 1000 | 18 x 36 | 2330 | 0.049 | 18 x 40 | 2370 | 0.044 | | | |
| 1200 | 18 x 40 | 2520 | 0.046 | | | | | | |
| 1500 | | | | | | | | | |
| 2200 | | | | | | | | | |
| 3300 | | | | | | | | | |
| 3900 | | | | | | | | | |
| 4700 | | | | | | | | | |
| 6800 | | | | | | | | | |
| 8200 | | | | | | | | | |
| 10000 | | | | | | | | | |
| 15000 | | | | | | | | | |

Note : * 1. D x L : mm

*2. Ripple Current : (mA r.m.s 105°C / 100kHz)

*3. ESR (Ω Max25°C / 100kHz)

Miniature Size Aluminum Electrolytic Capacitors

SY [For Low Impedance and Low E.S.R Suitable for Output of Mother Board]

105°C Single-Ended Lead Aluminum Electrolytic Capacitors For High Frequency Applications

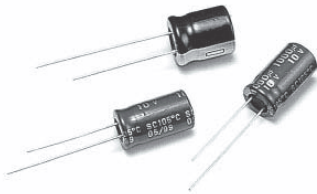

DESCRIPTION

Used in switching regulator applications in computers. Especially for high frequency.

Low impedance and E.S.R., high permissible ripple current at high frequency and higher operating temperature (-40°C to +105°C).

High Temperature Load Life at 105°C for 6000 Hours

Frequency coefficient

| Frequency(Hz) | 120 | 1K | 10K | 100K |
|---------------|------|------|------|------|
| 22~180μF | 0.40 | 0.75 | 0.90 | 1.00 |
| 220~560μF | 0.50 | 0.85 | 0.94 | 1.00 |
| 680~1800μF | 0.60 | 0.87 | 0.95 | 1.00 |
| 2200~3900μF | 0.75 | 0.90 | 0.95 | 1.00 |
| 4700μF Higher | 0.85 | 0.95 | 0.98 | 1.00 |

Temperature coefficient

| Temperature(°C) | 65 | 85 | 105 |
|-----------------|------|------|------|
| Factor | 1.80 | 1.50 | 1.00 |

DIAGRAM OF DIMENSIONS

■ Dimensions[mm]



ELECTRICAL CHARACTERISTICS

Operating Temperature : -40° ~ +105°C

Working Voltage : 6.3 ~ 50V

Rate Capacitance Range : 22 ~ 15000μF

Capacitance Tolerance : -20 ~ +20%

DC Leakage Current (μA) : I = 0.01 CV(μA) or 3μA. Whichever is greater.

(Measurements shall be Made After a 2 Minute Charge at Rated Working Voltage)

Dissipation Factor : at 120 Hz, 25°C

| | | | | | | |
|-----------|-----|----|----|----|----|----|
| WV (V) : | 6.3 | 10 | 16 | 25 | 35 | 50 |
| D.F (%) : | 22 | 19 | 16 | 14 | 12 | 10 |

For capacitor whose capacitance exceeds 1000μF. The value of D.F(%) is increased by 2% for every addition of 1000μF.

| | | | | | | | |
|-------------|---------------------|-----|----|----|----|----|----|
| WV (V) : | Rated Voltage (V) | 6.3 | 10 | 16 | 25 | 35 | 50 |
| Impedance : | Z - 25°C / Z + 20°C | 4 | 3 | 2 | 2 | 2 | 2 |
| Impedance : | Z - 40°C / Z + 20°C | 8 | 6 | 4 | 3 | 3 | 3 |

| | | | | |
|--------|---------|-----------|------------|---------|
| Dø : | 5ø-6.3ø | 8ø-10øx12 | 10øx15~12ø | 13ø-18ø |
| Life : | 3000hrs | 4000hrs | 5000hrs | 6000hrs |

If dimension is down size , Endurance will be less 1000 hrs than standard.

(a) Capacitance Change : Within 20% of Initial Value

(b) Dissipation Factor : Not Exceed 200% of Initial Requirement

(c) Leakage Current : Not Exceed the Initial Requirement

Shelf Life : 1000 Hours, No Voltage Applied, at 105°C

(a) Capacitance Change : Within 20% of Initial Value

(b) Dissipation Factor : Not more than 200% of specified value

(c) Leakage Current : Not more than 200% of specified value

Dimensions : mm

| Dø | F | dø |
|------|------|------|
| 4.0 | 1.5 | 0.45 |
| 5.0 | 2.0 | 0.5 |
| 6.0 | 2.5 | |
| 8.0 | 3.5 | |
| 10.0 | 5.0 | 0.6 |
| 12.0 | | |
| 13.0 | | |
| 16.0 | 7.5 | 0.8 |
| 18.0 | | |
| 22.0 | 10.0 | 0.8 |



CASE SIZE OF STANDARD PRODUCTS $D\phi \geq 6\text{mm}$ with Safety Vent at Can Bottom

| CAP. (μF) | RATED VOLTAGE | | | | | | | | |
|------------------------|---------------|--------|-----------|---------|--------|-----------|----------|--------|-----------|
| | 6.3 | | | 10 | | | 16 | | |
| | Size | Ripple | Impedance | Size | Ripple | Impedance | Size | Ripple | Impedance |
| 56 | | | | | | | 5 × 11 | 210 | 0.580 |
| 100 | | | | 5 × 11 | 210 | 0.580 | | | |
| 120 | | | | | | | 6.3 × 11 | 340 | 0.220 |
| 150 | 5 × 11 | 210 | 0.580 | | | | | | |
| 220 | 6 × 11 | 210 | 0.580 | 6 × 11 | 340 | 0.220 | | | |
| 330 | 6 × 11 | 340 | 0.220 | | | | 8 × 11 | 640 | 0.130 |
| 470 | | | | 8 × 11 | 640 | 0.130 | 8 × 15 | 840 | 0.087 |
| | | | | | | | 10 × 12 | 865 | 0.080 |
| 680 | 8 × 11 | 640 | 0.130 | 8 × 15 | 840 | 0.087 | 8 × 20 | 1050 | 0.069 |
| | | | | | | | 10 × 15 | 1210 | 0.060 |
| 820 | 10 × 12 | 865 | 0.080 | 10 × 12 | 865 | 0.080 | | | |
| 1000 | 8 × 15 | 840 | 0.087 | 8 × 20 | 1050 | 0.069 | 10 × 19 | 1400 | 0.046 |
| | | | | 10 × 15 | 1210 | 0.060 | 13 × 15 | 1450 | 0.049 |
| 1200 | 8 × 20 | 1050 | 0.069 | 10 × 19 | 1400 | 0.046 | 10 × 25 | 1650 | 0.042 |
| | 10 × 15 | 1210 | 0.060 | | | | | | |
| | 10 × 19 | 1400 | 0.046 | 10 × 25 | 1650 | 0.042 | 10 × 30 | 1910 | 0.031 |
| 1500 | | | | 13 × 15 | 1450 | 0.049 | 13 × 20 | 1900 | 0.035 |
| | | | | | | | 16 × 15 | 1940 | 0.042 |
| 1800 | 13 × 15 | 1450 | 0.049 | | | | | | |
| | 10 × 25 | 1650 | 0.042 | 10 × 30 | 1910 | 0.031 | 13 × 25 | 2230 | 0.027 |
| 2200 | | | | 13 × 20 | 1900 | 0.042 | 18 × 15 | 2210 | 0.043 |
| | | | | 16 × 15 | 1940 | 0.042 | | | |
| 2700 | 10 × 30 | 1910 | 0.031 | 18 × 15 | 2210 | 0.043 | 13 × 30 | 2650 | 0.024 |
| | 16 × 15 | 1940 | 0.042 | | | | 16 × 20 | 2530 | 0.027 |
| 3300 | 13 × 20 | 1900 | 0.035 | 13 × 25 | 2230 | 0.027 | 13 × 35 | 2880 | 0.020 |
| | 13 × 25 | 2230 | 0.027 | 13 × 30 | 2650 | 0.024 | 13 × 40 | 3350 | 0.017 |
| 3900 | 18 × 15 | 2210 | 0.043 | 16 × 20 | 2530 | 0.027 | 16 × 25 | 2930 | 0.021 |
| | | | | | | | 18 × 20 | 2860 | 0.026 |
| 4700 | 13 × 30 | 2650 | 0.024 | 13 × 35 | 2880 | 0.020 | 16 × 32 | 3450 | 0.017 |
| | | | | | | | 18 × 25 | 3140 | 0.019 |
| | 13 × 35 | 2880 | 0.020 | 13 × 40 | 3350 | 0.017 | 16 × 36 | 3610 | 0.015 |
| 5600 | 16 × 20 | 2530 | 0.027 | 16 × 25 | 2930 | 0.021 | 18 × 32 | 4170 | 0.015 |
| | | | | 18 × 20 | 2860 | 0.026 | | | |
| | 13 × 40 | 3350 | 0.017 | 16 × 32 | 3450 | 0.017 | 16 × 40 | 4080 | 0.013 |
| 6800 | 16 × 25 | 2930 | 0.021 | 18 × 25 | 3140 | 0.019 | | | |
| | 18 × 20 | 2860 | 0.026 | | | | | | |
| 8200 | 16 × 32 | 3450 | 0.017 | 16 × 36 | 3610 | 0.015 | 18 × 36 | 4220 | 0.014 |
| | | | | 18 × 32 | 4170 | 0.015 | | | |
| 10000 | 16 × 36 | 3610 | 0.015 | 16 × 40 | 4080 | 0.013 | 18 × 40 | 4280 | 0.012 |
| | 18 × 25 | 3140 | 0.017 | 18 × 36 | 4220 | 0.014 | | | |
| 12000 | 18 × 32 | 4170 | 0.015 | 18 × 40 | 4280 | 0.012 | | | |
| 15000 | 18 × 36 | 4220 | 0.014 | | | | | | |

Note : * 1. D × L : mm

*2. Ripple Current : (mA r.m.s 105°C / 100KHz), Impedance (Ω Max25°C / 100KHz)



CASE SIZE OF STANDARD PRODUCTS $D\phi \geq 6\text{mm}$ with Safety Vent at Can Bottom

| CAP. (μF) | RATED VOLTAGE | | | | | | | | |
|------------------------|---------------|--------------|-----------|---------|--------------|-----------|---------|--------------|-----------|
| | Size | 25 Ripple | Impedance | Size | 35 Ripple | Impedance | Size | 50 Ripple | Impedance |
| 22 | | | | | | | 5 × 11 | 180 | 0.700 |
| 33 | | | | 5 × 11 | 210 | 0.580 | | | |
| 47 | 5 × 11 | 210 | 0.580 | | | | | | |
| 56 | | | | 6 × 11 | 340 | 0.220 | 6 × 11 | 295 | 0.300 |
| 100 | 6 × 11 | 340 | 0.220 | | | | 8 × 11 | 555 | 0.170 |
| 120 | 6 × 11 | 340 | 0.220 | | | | 8 × 15 | 730 | 0.120 |
| 150 | | | | 8 × 11 | 640 | 0.130 | 10 × 12 | 760 | 0.120 |
| 180 | | | | | | | 8 × 20 | 910 | 0.091 |
| 220 | 8 × 11 | 640 | 0.130 | 8 × 15 | 840 | 0.087 | 10 × 15 | 1050 | 0.084 |
| | | | | 10 × 12 | 865 | 0.080 | | | |
| 270 | | | | 8 × 20 | 1050 | 0.069 | 10 × 19 | 1220 | 0.060 |
| | | | | | | | 13 × 15 | 1260 | 0.061 |
| 330 | 8 × 15 | 840 | 0.087 | 10 × 15 | 1210 | 0.060 | 10 × 25 | 1440 | 0.055 |
| | 10 × 12 | 865 | 0.080 | | | | | | |
| | 8 × 20 | 1050 | 0.069 | 10 × 19 | 1400 | 0.046 | 10 × 30 | 1690 | 0.043 |
| 470 | 10 × 15 | 1210 | 0.060 | 13 × 15 | 1450 | 0.049 | 13 × 20 | 1660 | 0.045 |
| | | | | | | | 16 × 15 | 1690 | 0.055 |
| 560 | | | | 10 × 25 | 1650 | 0.042 | 13 × 25 | 1950 | 0.034 |
| | | | | | | | 18 × 15 | 1930 | 0.054 |
| | 10 × 19 | 1400 | 0.046 | 10 × 30 | 1910 | 0.031 | 13 × 30 | 2310 | 0.030 |
| 680 | 13 × 15 | 1450 | 0.049 | 13 × 20 | 1900 | 0.035 | | | |
| | | | | 16 × 15 | 1940 | 0.042 | | | |
| 820 | 10 × 25 | 1650 | 0.042 | | | | 13 × 35 | 2510 | 0.025 |
| | | | | | | | 16 × 20 | 2210 | 0.034 |
| | 10 × 30 | 1910 | 0.031 | 13 × 25 | 2230 | 0.027 | 13 × 40 | 2920 | 0.021 |
| 1000 | 13 × 20 | 1900 | 0.035 | 18 × 15 | 2210 | 0.043 | 16 × 25 | 2555 | 0.025 |
| | 16 × 15 | 1940 | 0.042 | | | | 18 × 20 | 2490 | 0.036 |
| 1200 | 18 × 15 | 2210 | 0.043 | 13 × 30 | 2650 | 0.024 | 16 × 32 | 3010 | 0.022 |
| | | | | 16 × 20 | 2530 | 0.027 | 18 × 25 | 2740 | 0.026 |
| 1500 | 13 × 25 | 2230 | 0.027 | 13 × 35 | 2880 | 0.020 | 16 × 36 | 3150 | 0.019 |
| | 13 × 30 | 2650 | 0.024 | 13 × 40 | 3350 | 0.017 | 16 × 40 | 3710 | 0.016 |
| 1800 | 16 × 20 | 2530 | 0.027 | 16 × 25 | 2930 | 0.021 | 18 × 32 | 3635 | 0.021 |
| | | | | 18 × 20 | 2860 | 0.026 | | | |
| 2200 | 13 × 35 | 2880 | 0.020 | 16 × 32 | 3450 | 0.017 | 18 × 36 | 3680 | 0.017 |
| | 18 × 20 | 2860 | 0.026 | 18 × 25 | 3140 | 0.019 | | | |
| 2700 | 13 × 40 | 3350 | 0.017 | 16 × 36 | 3610 | 0.015 | 18 × 40 | 3800 | 0.014 |
| | 16 × 25 | 2930 | 0.021 | 18 × 32 | 4170 | 0.015 | | | |
| 3300 | 16 × 32 | 3450 | 0.017 | 16 × 40 | 4080 | 0.013 | | | |
| | 16 × 25 | 3140 | 0.019 | 18 × 36 | 4220 | 0.014 | | | |
| 3900 | 18 × 32 | 4170 | 0.015 | 18 × 40 | 4280 | 0.012 | | | |
| 4700 | 18 × 36 | 4220 | 0.014 | | | | | | |
| 5600 | 18 × 40 | 4280 | 0.012 | | | | | | |

Note : * 1. D × L : mm

*2. Ripple Current : (mA r.m.s 105°C / 100KHz), Impedance (Ω Max25°C / 100KHz)

Miniature Size Aluminum Electrolytic Capacitors

SZ [Ultra Low ESR]

105°C Single-Ended Lead Aluminum Electrolytic Capacitors For High Frequency Applications



DESCRIPTION

Used in switching regulator applications in computers. Especially for high frequency.

Low impedance and E.S.R., high permissible ripple current at high frequency and higher operating temperature (-40°C to +105°C).

High Temperature Load Life at 105°C for 2000 Hours

Frequency coefficient

| | | | | |
|---------------|------|------|------|--------|
| Frequency(Hz) | 120 | 1K | 10K | 100K ≤ |
| Factor | 0.50 | 0.80 | 0.90 | 1.00 |

Temperature coefficient

| | | | |
|-----------------|------|------|------|
| Temperature(°C) | 65 | 85 | 105 |
| Factor | 2.10 | 1.70 | 1.00 |

DIAGRAM OF DIMENSIONS



ELECTRICAL CHARACTERISTICS

Operating Temperature : -40° ~ +105°C

Working Voltage : 6.3 ~ 16V

Rate Capacitance Range : 470 ~ 3300μF

Capacitance Tolerance : -20 ~ +20%

DC Leakage Current (μA) : I = 0.03 CV Whichever is greater.

(Measurements shall be Made After a 2 Minute Charge at Rated Working Voltage)

Dissipation Factor : at 120 Hz, 25°C

WV (V) : $\frac{6.3}{22}$ - $\frac{10}{19}$ - $\frac{16}{16}$
 D.F (%) :

For capacitor whose capacitance exceeds 1000μF. The value of D.F.(%) is increased by 2% for every addition of 1000μF.

WV (V) : Rated Voltage (V) $\frac{6.3}{2}$ - $\frac{10}{2}$ - $\frac{16}{3}$
 Impedance : Z - 25°C / Z + 20°C $\frac{2}{3}$ - $\frac{2}{3}$ - $\frac{2}{3}$
 Impedance : Z - 40°C / Z + 20°C $\frac{2}{3}$ - $\frac{2}{3}$ - $\frac{2}{3}$

Load Life : 2000 Hours at 105°C Assured with Full Rated Maximum Ripple Current Applied

- (a) Capacitance Change : Within 20% of Initial Value
- (b) Dissipation Factor : Not Exceed 200% of Initial Requirement
- (c) Leakage Current : Not Exceed the Initial Requirement

Shelf Life : 1000 Hours, No Voltage Applied, at 105°C

- (a) Capacitance Change : Within 20% of Initial Value
- (b) Dissipation Factor : Not Exceed 200 % of Initial Requirement
- (c) Leakage Current : Not Exceed 200% of Initial Requirement

Dimensions : mm

Rubber Stand-off



L ≤ 12 L + 1.5Max.
 13 ≤ L ≤ 15 L $\frac{+1.0}{-0.5}$
 L ≥ 16 L + 2.0Max.

| Dø | F | dø |
|------|------|------|
| 4.0 | 1.5 | 0.45 |
| 5.0 | 2.0 | 0.5 |
| 6.0 | 2.5 | |
| 8.0 | 3.5 | |
| 10.0 | 5.0 | 0.6 |
| 12.0 | | |
| 13.0 | | |
| 16.0 | 7.5 | 0.8 |
| 18.0 | | |
| 22.0 | 10.0 | 0.8 |



CASE SIZE OF STANDARD PRODUCTS $D\phi \geq 6\text{mm}$ with Safety Vent at Can Bottom

| CAP. (μF) | RATED VOLTAGE WV | | | | | | | | |
|------------------------|------------------|---------------|-----|---------|--------------|-----|---------|--------------|-----|
| | SIZE | 6.3 Ripple | ESR | SIZE | 10 Ripple | ESR | SIZE | 16 Ripple | ESR |
| 470 | | | | | | | 8 x 11 | 1140 | 36 |
| 680 | | | | 8 x 11 | 1140 | 36 | 8 x 15 | 1490 | 28 |
| | | | | | | | 10 x 12 | 1540 | 26 |
| 820 | 8 x 11 | 1140 | 36 | | | | | | |
| 1000 | | | | 8 x 15 | 1490 | 28 | 8 x 20 | 1870 | 19 |
| | | | | 10 x 12 | 1540 | 26 | 10 x 15 | 2000 | 19 |
| 1200 | 8 x 15 | 1490 | 28 | | | | | | |
| 1500 | 10 x 12 | 1540 | 26 | 8 x 20 | 1870 | 19 | 10 x 19 | 2550 | 13 |
| | | | | 10 x 15 | 2000 | 19 | | | |
| 1800 | 8 x 20 | 1870 | 19 | 10 x 19 | 2550 | 13 | 10 x 22 | 2800 | 12 |
| | 10 x 15 | 2000 | 19 | | | | | | |
| 2200 | 10 x 19 | 2550 | 13 | 10 x 22 | 2800 | 12 | | | |
| 3300 | 10 x 22 | 2800 | 12 | | | | | | |

Note : * 1. D x L : mm

*2. Ripple Current : (mA r.m.s 105°C / 100KHz), ESR ($M\Omega$ Max25°C / 100KHz)

Miniature Size Aluminum Electrolytic Capacitors

SQ [High Temperature for +125°C]

125°C Single-Ended Lead Aluminum Electrolytic Capacitors For High Frequency Applications



DESCRIPTION

Wide operating temperature range it as long load life product at 125°C

Suit for use in DC or pulse circuits in various electronic and industrial

ELECTRICAL CHARACTERISTICS

Operating Temperature : -40° ~ +125°C

Working Voltage : 10 ~ 50V

Rate Capacitance Range : 4.7 ~ 3900μF

Capacitance Tolerance : -20 ~ +20%

DC Leakage Current (μA) : $1 \leq 0.03 CV(\mu A)$ or $4\mu A$ Whichever is greater.

(Measurements shall be Made After a 2 Minute Charge at Rated Working Voltage)

Dissipation Factor : at 120 Hz, 25°C

| | | | | | | |
|-----------|----|----|----|----|----|-------|
| WV (V) : | 10 | 16 | 25 | 35 | 50 | ----- |
| D.F (%) : | 15 | 12 | 10 | 10 | 8 | ----- |

Value in () are applicable for products which dimensions are in ().

| | | | | | | |
|-------------|---------------------|----|----|----|----|----|
| WV (V) : | Rated Voltage (V) | 10 | 16 | 25 | 35 | 50 |
| Impedance : | Z - 25°C / Z + 20°C | 3 | 2 | 2 | 2 | 2 |
| Impedance : | Z - 40°C / Z + 20°C | 6 | 4 | 4 | 4 | 4 |

Load Life : 1000 Hours at 125°C Assured with Full Rated Maximum Ripple Current Applied

- (a) Capacitance Change : Within 20% of Initial Value
- (b) Dissipation Factor : Not Exceed 200% of Initial Requirement
- (c) Leakage Current : Not Exceed the Initial Requirement

Shelf Life : 1000 Hours, No Voltage Applied, at 125°C

- (a) Capacitance Change : Within 20% of Initial Value
- (b) Dissipation Factor : Not Exceed 200 % of Initial Requirement
- (c) Leakage Current : Not Exceed 200% of Initial Requirement

DIAGRAM OF DIMENSIONS



Rubber Stand-off

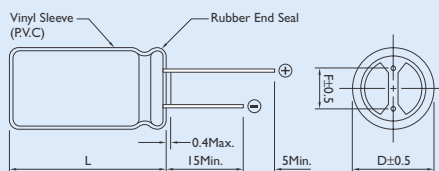

$L \leq 12$ $L + 1.5\text{Max.}$
 $13 \leq L \leq 15$ $L^{+1.0}_{-0.5}$
 $L \geq 16$ $L + 2.0\text{Max.}$

Dimensions : mm

| Dø | F | dø |
|------|------|------|
| 4.0 | 1.5 | 0.45 |
| 5.0 | 2.0 | 0.5 |
| 6.0 | 2.5 | |
| 8.0 | 3.5 | |
| 10.0 | 5.0 | 0.6 |
| 12.0 | | |
| 13.0 | | |
| 16.0 | 7.5 | 0.8 |
| 18.0 | | |
| 22.0 | 10.0 | 0.8 |



CASE SIZE & PERMISSIBLE RIPPLE CURRENT OF STANDARD PRODUCTS

| CAP. (μ F) | RATED VOLTAGE WV | | | | |
|-----------------|------------------|---------|---------|---------|---------|
| | 10 | 16 | 25 | 35 | 50 |
| 0.47 | | | | | 8 x 11 |
| 1 | | | | | 8 x 11 |
| 2.2 | | | | | 8 x 11 |
| 3.3 | | | | | 8 x 11 |
| 4.7 | | | | | 8 x 11 |
| 10 | | | | | 8 x 11 |
| 22 | | | | 8 x 11 | 10 x 12 |
| 33 | | | 8 x 11 | 10 x 12 | 10 x 15 |
| 47 | | 8 x 11 | 10 x 12 | 10 x 15 | 10 x 19 |
| 100 | 10 x 12 | 10 x 15 | 10 x 19 | 13 x 20 | 13 x 25 |
| 220 | 10 x 19 | 13 x 20 | 13 x 25 | 16 x 25 | |
| 330 | 13 x 20 | 13 x 25 | 16 x 25 | | |
| 470 | 13 x 25 | 16 x 25 | | | |
| 1000 | | | 16 x 32 | | |
| 2200 | | | 16 x 32 | | |
| 3900 | | | 18 x 36 | | |

Note : * L, D x L : mm

Miniature Size Aluminum Electrolytic Capacitors

SV [For adapter and power supply applications Series]

105°C Single-Ended Lead Aluminum Electrolytic Capacitors For High Frequency Applications



DESCRIPTION

Used in switching regulator applications in computers. Especially for high frequency.

Low impedance and E.S.R., high permissible ripple current at high frequency and higher operating temperature (-40°C to +105°C).

Frequency coefficient

| | | | | |
|---------------|------|------|------|----------|
| Frequency(Hz) | 120 | 500 | 1K | 10K~100K |
| Coefficient | 1.00 | 1.20 | 1.40 | 1.50 |

Temperature coefficient

| | | | |
|-----------------|------|------|------|
| Temperature(°C) | 65 | 85 | 105 |
| Factor | 2.10 | 1.70 | 1.00 |

DIAGRAM OF DIMENSIONS



Rubber Stand-off



$L \leq 12$ $L + 1.5\text{Max.}$
 $13 \leq L \leq 15$ $L^{+1.0}_{-0.5}$
 $L \geq 16$ $L + 2.0\text{Max.}$

Dimensions : mm

| Dø | F | dø |
|------|------|------|
| 4.0 | 1.5 | 0.45 |
| 5.0 | 2.0 | 0.5 |
| 6.0 | 2.5 | |
| 8.0 | 3.5 | |
| 10.0 | 5.0 | 0.6 |
| 12.0 | | |
| 13.0 | | |
| 16.0 | 7.5 | 0.8 |
| 18.0 | | |
| 22.0 | 10.0 | 0.8 |

ELECTRICAL CHARACTERISTICS

Operating Temperature : -40° ~ +105°C -25° ~ +105°C

Working Voltage : 200V 400V

Rate Capacitance Range : 22 ~ 220µF 10 ~ 150µF

Capacitance Tolerance : -20 ~ +20%

DC Leakage Current (µA) : $I = 0.06 CV + 10(\mu A)$

whichever is greater.(After 2 minutes application of rated voltage at 25°C)

Dissipation Factor : at 120 Hz, 25°C

$\frac{WV(V)}{D.F.(\%)} : \frac{200}{15} \quad \frac{400}{20}$

$\frac{WV(V)}{\text{Impedance}} : \frac{200}{3} \quad \frac{400}{5}$
 $\frac{WV(V)}{\text{Impedance}} : \frac{200}{6} \quad \frac{400}{-}$

Load Life : After apply rated voltage with rated ripple current for 2000hrs at 105°C the capacitors shall meet the following requirements.

- (a) Capacitance Change : Within 20% of Initial Value
- (b) Dissipation Factor : Not Exceed 200% of Initial Requirement
- (c) Leakage Current : Not Exceed the Initial Requirement

Shelf Life : 1000 Hours, No Voltage Applied, at 105°C

- (a) Capacitance Change : Within 20% of Initial Value
- (b) Dissipation Factor : Not Exceed 200 % of Initial Requirement
- (c) Leakage Current : Not Exceed 200% of Initial Requirement



PERMISSIBLE RIPPLE CURRENT (mA, rms) at 105°C, 120HZ

| CAP. (μF) | RATED VOLTAGE WV | | | |
|-----------|------------------|---------------|---------|---------------|
| | Size | 200 Ripple | Size | 400 Ripple |
| 10 | | | 10 × 15 | 64 |
| | | | 10 × 19 | 120 |
| | | | 13 × 25 | 200 |
| 22 | 10 × 19 | 233 | 12 × 25 | 190 |
| | | | 13 × 25 | 225 |
| | | | 16 × 25 | 300 |
| 33 | 13 × 20 | 366 | 16 × 20 | 360 |
| | | | 16 × 25 | 400 |
| | | | 16 × 32 | 437 |
| 47 | 13 × 25 | 400 | 13 × 30 | 370 |
| | | | 16 × 25 | 450 |
| | | | 18 × 25 | 470 |
| | | | 18 × 32 | 538 |
| 68 | 13 × 25 | 600 | 13 × 40 | 480 |
| | | | 18 × 25 | 480 |
| 82 | | | 16 × 32 | 520 |
| | | | 18 × 32 | 520 |
| 100 | 16 × 32 | 800 | 18 × 32 | 580 |
| 120 | | | 18 × 32 | 670 |
| | | | 18 × 32 | 670 |
| 150 | | | 18 × 36 | 700 |
| 220 | 16 × 36 | 933 | | |

Note : * 1. D × L : mm

*2. Ripple Current : (mA rms 105°C / 120Hz)

Miniature Size Aluminum Electrolytic Capacitors

SF [For Photo Flash Applications]

105°C Single-Ended Lead, 5.0mm Height Type Aluminum Electrolytic Capacitors



DESCRIPTION

Applications : Digital Camera

ELECTRICAL CHARACTERISTICS

Operating Temperature : -25° ~ +55°C

Working Voltage : 300, 330, 360V

Rate Capacitance Range : 36 ~ 300μF

Capacitance Tolerance : -10 ~ +20%

DC Leakage Current : $I = 1 \times C (\mu A)$ max.(After 5 minute)

Dissipation Factor : Less than 0.06

Charge and Discharge Characteristics :

Test condition : For 5000 times at room temperature (5~35°C)

Charge & discharge cycles : 30 sec

Leakage current : $\leq 150\%$ of initial specified value

Capacitance change : within $\pm 10\%$ of initial value

tan d(DF) : $\leq 150\%$ of initial specified value

Shelf Life:

Storage without voltage applied at 55°C for 1000 hours and measured at 25°C

(a) Leakage current : $\leq 150\%$ of initial specified value

(b) Capacitance change : within $\pm 20\%$ of initial value

(c) tan δ (DF) : $\leq 150\%$ of initial specified value

DIAGRAM OF DIMENSIONS

Dimensions : mm

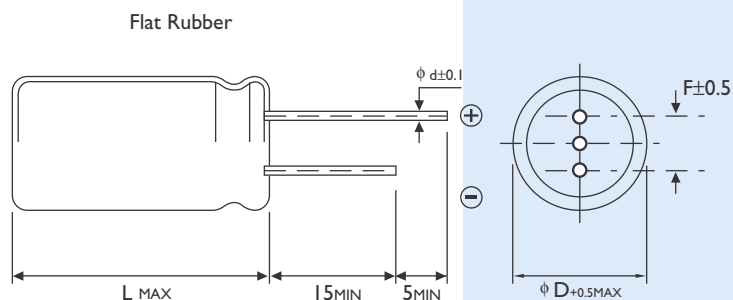

| Dø | F | dø |
|------|-----|-----|
| 10 | 5.0 | 0.6 |
| 12.5 | 5.0 | 0.8 |
| 13 | 5.0 | 0.8 |
| 14.5 | 7.5 | 0.8 |
| 16 | 7.5 | 0.8 |
| 18 | 7.5 | 0.8 |
| 20 | 7.5 | 0.8 |



CASE SIZE & PERMISSIBLE RIPPLE CURRENT OF STANDARD PRODUCTS

| CAP. (μ F) | RATED VOLTAGE WV | | | | | | |
|-----------------|------------------|-----------|---------|-----------|---------|---------|---------|
| | 10 | 12.5 | 13 | 14.5 | 16 | 18 | 20 |
| 36 | 10 x 27 | | | | | | |
| 47 | 10 x 30 | 12.5 x 20 | | | | | |
| 60 | 10 x 34 | 12.5 x 23 | | | | | |
| 80 | | 12.5 x 27 | | | | | |
| 100 | | 12.5 x 34 | 13 x 34 | 14.5 x 26 | | | |
| 120 | | 12.5 x 37 | 13 x 34 | 14.5 x 30 | 16 x 27 | | |
| 140 | | 12.5 x 42 | 13 x 39 | 14.5 x 33 | 16 x 29 | 18 x 25 | |
| 160 | | 12.5 x 47 | 13 x 43 | 14.5 x 36 | 16 x 32 | 18 x 27 | |
| 180 | | | | 14.5 x 40 | 16 x 35 | 18 x 29 | |
| 200 | | | | 14.5 x 43 | 16 x 38 | 18 x 31 | |
| 220 | | | | 14.5 x 47 | 16 x 40 | 18 x 33 | |
| 240 | | | | | 16 x 43 | 18 x 36 | |
| 250 | | | | | | 18 x 37 | 20 x 31 |
| 300 | | | | | | 18 x 42 | 20 x 35 |

Note : * 1. D x L : mm

* 2. Flat Rubbet

Miniature Size Aluminum Electrolytic Capacitors

LH [For 85°C, 2000 Hours Miniature]

For Printed Circuit Board High-Performance Aluminum Electrolytic Power Supply Input and Output Filter Capacitors

ELECTRICAL CHARACTERISTICS

| | | |
|-----------------------------|--|---|
| Operating Temperature Range | -40 to +85°C | -25 to +85°C |
| Rated Voltage Range | 6.3 to 100VDC | 160 to 450VDC |
| Capacitance Tolerance | ±20% (at 25°C, 120Hz) | |
| Leakage Current | I = 0.02CV or 3mA Whichever is smaller. (At 25°C, After 5 Minutes Application of DC Working Voltage at 25°C) | |
| Dissipation Factor | Where, I; Leakage Current (μA) C: Nominal Capacitance (μF) V; Rated Voltage (V) | |
| | Rate Voltage (V) | 6.3 10 16 25 35 50~80 100 160~250 315~450 |
| | D.F (%) | 60 50 40 25 25 20 15 10* 15 |
| | Note: * (15%) For Case Size D = 35m/m or L = 20m/m (At 120Hz, 25°C) | |
| | (WV = 6.3 ~ 100V For Capacitor Whose Capacitance Exceeds 1000μF) | |
| Load Life | The value of D.F.(%) is increased by 2% for every addition of 1000μF. | |
| | Rated Voltage(v) | 6.3~16 25 35 50~63 80~100 160~400 450 |
| | Z(-25°C) / Z(20°C) | 3 3 3 2 2 4 8 |
| | Z(-40°C) / Z(20°C) | 12 10 8 6 5 - - |
| Shelf Life | After the capacitors are subjected to DC with the full rated ripple current applied at 85°C for 2000 hours. The following specifications shall be satisfied when the capacitors are restored to 25°C the sum of DC voltage and peak AC voltage must not exceed their full rated voltage. | |
| | Capacitance Change | ≤ ±20% of the Initial Value |
| | D.F (tanδ) | ≤ 200% of the Initial Specified Value |
| | Leakage Current | ≤ the Initial Specified Value |
| Shelf Life | The following specifications shall be satisfied when the capacitor are restored to 25°C after exposing them for 1000 hours at 85°C without voltage applied. | |
| | Capacitance Change | ≤ ±20% of the Initial Value |
| | D.F (%) | ≤ 150% of the Initial Specified Value |
| | Leakage Current | ≤ 150% of the Initial Specified Value |

DIAGRAM OF DIMENSIONS



DESCRIPTION



LH type capacitors, size are combined with snap-lock terminals for easy to mount on P.C. Board.

They are ideally suitable to be used in switching.

Power Supplies and Orther Industrial or Commercial Applications

Multiplier for Ripple Current

Frequency coefficient

| Frequency(Hz) | 50 | 60 | 120 | 1K | 10K~00K |
|---------------|------|------|------|------|---------|
| 6.3~100V | 0.88 | 0.90 | 1.00 | 1.15 | 1.16 |
| 160~250V | 0.75 | 0.78 | 1.00 | 1.16 | 1.23 |
| 350~450V | 0.74 | 0.76 | 1.00 | 1.10 | 1.15 |

Temperature coefficient

| Temperature(°C) | 60 | 70 | 85 |
|-----------------|------|------|------|
| Factor | 1.42 | 1.30 | 1.00 |

Unit : mm

Location of P.C.B. Holes





CASE SIZE OF STANDARD PRODUCTS AND PERMISSIBLE RIPPLE CURRENT

| CAP. (μF) | RATED VOLTAGE WV | | | | | | | |
|-----------|--|------------------------------|--|------------------------------|--|------------------------------|--|------------------------------|
| | 6.3 | | 10 | | 16 | | 25 | |
| | Size | Ripple | Size | Ripple | Size | Ripple | Size | Ripple |
| 5600 | | | | | | | 22 × 25 | 2.20 |
| 6800 | | | | | | | 22 × 30 25 × 25 | 2.40 2.45 |
| 8200 | | | | | 22 × 25 | 2.60 | 22 × 35 25 × 25 | 2.70 2.75 |
| 10000 | | | | | 22 × 30 25 × 25 | 2.70 2.75 | 22 × 40 25 × 30 30 × 25 | 3.10 3.15 3.20 |
| 12000 | | | 22 × 25 | 2.40 | 22 × 30 25 × 25 | 2.90 2.95 | 22 × 45 25 × 35 30 × 30 35 × 25 | 3.50 3.45 3.50 3.55 |
| 15000 | 22 × 25 | 2.44 | 22 × 30 25 × 25 | 2.75 2.75 | 22 × 35 25 × 30 30 × 25 | 3.30 3.45 3.50 | 22 × 50 25 × 40 30 × 35 35 × 30 | 4.00 3.95 4.00 4.05 |
| 18000 | 22 × 30 25 × 25 | 2.60 2.62 | 22 × 35 25 × 25 | 3.15 3.05 | 22 × 40 25 × 35 30 × 30 | 3.70 3.75 3.80 | 25 × 45 30 × 35 35 × 30 | 4.45 4.45 4.60 |
| 22000 | 22 × 30 25 × 25 | 3.06 3.07 | 22 × 40 25 × 30 30 × 25 | 3.55 3.50 3.55 | 22 × 50 25 × 40 30 × 30 35 × 25 | 4.35 4.30 4.25 4.20 | 30 × 40 35 × 35 | 5.20 5.15 |
| 27000 | 22 × 35 25 × 30 30 × 25 | 3.49 3.52 3.57 | 22 × 45 25 × 35 30 × 30 | 4.05 4.00 4.05 | 25 × 45 30 × 35 35 × 30 | 4.70 4.65 4.65 | 30 × 45 35 × 40 | 5.95 5.90 |
| 33000 | 22 × 40 25 × 35 30 × 30 35 × 25 | 3.97 4.02 4.05 4.10 | 22 × 50 25 × 40 30 × 30 35 × 25 | 4.60 4.55 4.50 4.50 | 30 × 40 35 × 30 | 5.35 5.40 | 30 × 50 35 × 45 | 6.70 6.75 |
| 39000 | 22 × 50 25 × 40 30 × 30 35 × 25 | 4.56 4.50 4.46 4.51 | 25 × 45 30 × 35 35 × 30 | 5.10 5.05 5.05 | 30 × 45 35 × 35 | 6.00 5.95 | 35 × 50 | 7.55 |
| 47000 | 25 × 45 30 × 35 35 × 30 | 5.09 5.06 5.03 | 25 × 50 30 × 40 35 × 30 | 5.75 5.70 5.65 | 30 × 50 35 × 40 | 6.80 6.75 | | |
| 56000 | 25 × 50 30 × 40 35 × 30 | 5.71 5.70 5.75 | 30 × 45 35 × 35 | 6.45 6.40 | 35 × 45 | 7.60 | | |
| 68000 | 30 × 45 35 × 35 | 6.48 6.42 | 30 × 50 35 × 40 | 7.05 7.10 | 35 × 50 | 8.00 | | |
| 82000 | 30 × 50 35 × 40 | 7.32 7.29 | 35 × 50 | 7.50 | | | | |
| 100000 | 35 × 45 | 8.31 | | | | | | |
| 120000 | 35 × 50 | 8.60 | | | | | | |

Note : *1. D × L : mm

*2. Ripple Current : (mA r.m.s 85°C / 120Hz)



CASE SIZE OF STANDARD PRODUCTS AND PERMISSIBLE RIPPLE CURRENT

| CAP. (μF) | RATED VOLTAGE WV | | | | | | | |
|-----------|------------------|--------|---------|---------|---------|--------|---------|--------|
| | 35 | | 50 | | 63 | | 80 | |
| | Size | Ripple | Size | Ripple | Size | Ripple | Size | Ripple |
| 1200 | | | | | | | 22 × 25 | 1.65 |
| 1500 | | | | | | | 22 × 30 | 1.90 |
| | | | | | | | 25 × 25 | 1.90 |
| 1800 | | | | | 22 × 25 | 1.85 | 22 × 35 | 2.20 |
| | | | | | | | 25 × 30 | 2.20 |
| | | | | | | | 30 × 25 | 2.20 |
| 2200 | | | 22 × 25 | 1.90 | 22 × 30 | 2.30 | 22 × 40 | 2.45 |
| | | | | | 25 × 25 | 2.30 | 25 × 30 | 2.45 |
| | | | | | | | 30 × 25 | 2.50 |
| 2700 | | | 22 × 30 | 2.10 | 22 × 35 | 2.45 | 22 × 45 | 2.80 |
| | | | 25 × 25 | 2.20 | 25 × 30 | 2.45 | 25 × 35 | 2.80 |
| | | | | | 30 × 25 | 2.50 | 30 × 30 | 2.85 |
| | | | | | | | 35 × 25 | 2.85 |
| 3000 | | | 22 × 30 | 2.35 | 22 × 40 | 2.60 | 22 × 50 | 3.15 |
| | | | 25 × 25 | 2.35 | 25 × 30 | 2.65 | 25 × 40 | 3.20 |
| | | | | | 30 × 25 | 2.70 | 30 × 30 | 3.20 |
| | | | | | | | 35 × 25 | 3.20 |
| 3900 | 22 × 25 | 2.20 | 22 × 35 | 2.65 | 22 × 45 | 2.95 | 25 × 45 | 3.60 |
| | | | 25 × 30 | 2.65 | 25 × 35 | 2.95 | 30 × 35 | 3.60 |
| | | | 30 × 25 | 2.65 | 30 × 30 | 3.00 | 35 × 30 | 3.60 |
| 4700 | 22 × 30 | 2.40 | 22 × 40 | 3.00 | 22 × 50 | 3.40 | 25 × 50 | 4.05 |
| | 25 × 25 | 2.40 | 25 × 35 | 3.00 | 25 × 40 | 3.35 | 30 × 40 | 4.05 |
| | | | 30 × 25 | 2.95 | 30 × 30 | 3.35 | 35 × 35 | 4.10 |
| | | | | 35 × 25 | 3.40 | | | |
| 5600 | 22 × 35 | 2.75 | 22 × 45 | 3.35 | 25 × 45 | 3.70 | 30 × 45 | 4.55 |
| | 25 × 25 | 2.75 | 25 × 40 | 3.35 | 30 × 35 | 3.75 | 35 × 35 | 4.50 |
| | | | 30 × 30 | 3.35 | 35 × 30 | 3.75 | | |
| | | | 35 × 25 | 3.40 | | | | |
| 6800 | 22 × 40 | 2.85 | 22 × 50 | 3.80 | 30 × 40 | 4.25 | 30 × 50 | 5.15 |
| | 25 × 30 | 2.85 | 25 × 40 | 3.80 | 35 × 30 | 4.20 | 35 × 40 | 5.15 |
| | 30 × 25 | 2.90 | 30 × 30 | 3.80 | | | | |
| | | | 30 × 35 | 3.85 | | | | |
| | | | 35 × 30 | 3.85 | | | | |
| 8200 | 22 × 45 | 3.15 | 25 × 50 | 4.35 | 30 × 45 | 4.80 | 35 × 45 | 5.85 |
| | 25 × 35 | 3.10 | 30 × 40 | 4.35 | 35 × 35 | 4.80 | | |
| | 30 × 30 | 3.15 | 35 × 30 | 4.40 | | | | |
| 10000 | 22 × 50 | 3.55 | 30 × 45 | 5.00 | 30 × 50 | 5.50 | 35 × 50 | 6.60 |
| | 25 × 40 | 3.50 | 35 × 35 | 4.95 | 35 × 40 | 5.45 | | |
| | 30 × 30 | 3.45 | | | | | | |
| | 35 × 25 | 3.40 | | | | | | |
| 12000 | 25 × 45 | 3.95 | 30 × 50 | 5.60 | 35 × 45 | 6.20 | | |
| | 30 × 35 | 4.00 | 35 × 40 | 5.55 | | | | |
| | 35 × 30 | 4.05 | | | | | | |
| 15000 | 25 × 50 | 4.95 | 35 × 45 | 6.45 | | | | |
| | 30 × 40 | 4.95 | | | | | | |
| | 35 × 35 | 5.00 | | | | | | |
| 18000 | 30 × 45 | 5.50 | 35 × 50 | 6.70 | | | | |
| | 35 × 40 | 5.55 | | | | | | |
| 22000 | 30 × 50 | 6.00 | | | | | | |
| | 35 × 45 | 6.05 | | | | | | |
| 27000 | 35 × 50 | 6.90 | | | | | | |

Note : *1. D × L : mm

*2. Ripple Current : (mA r.m.s 85°C / 120Hz)



CASE SIZE OF STANDARD PRODUCTS AND PERMISSIBLE RIPPLE CURRENT

| CAP. (μF) | RATED VOLTAGE WV | | | | | | | |
|-----------|------------------|--------|---------|--------|---------|--------|---------|--------|
| | 100 | | 160 | | 180 | | 200 | |
| | Size | Ripple | Size | Ripple | Size | Ripple | Size | Ripple |
| 180 | | | | | 22 × 20 | 1.00 | 22 × 25 | 0.95 |
| 220 | | | | | 22 × 25 | 1.10 | 22 × 25 | 1.10 |
| 270 | | | 22 × 25 | 1.15 | 22 × 25 | 1.25 | 22 × 25 | 1.25 |
| | | | | | 25 × 20 | 1.25 | 22 × 30 | 1.25 |
| | | | | | | | 25 × 25 | 1.25 |
| 330 | | | 22 × 25 | 1.40 | 22 × 25 | 1.40 | 22 × 25 | 1.45 |
| | | | 25 × 20 | 1.35 | 22 × 30 | 1.40 | 22 × 30 | 1.45 |
| | | | | | 25 × 25 | 1.40 | 25 × 25 | 1.45 |
| 390 | | | 22 × 30 | 1.55 | 22 × 30 | 1.60 | 22 × 30 | 1.60 |
| | | | 25 × 25 | 1.55 | 25 × 25 | 1.60 | 25 × 25 | 1.55 |
| | | | 30 × 25 | 1.50 | | | | |
| 470 | | | 22 × 30 | 1.75 | 22 × 35 | 1.80 | 22 × 35 | 1.80 |
| | | | 25 × 25 | 1.75 | 25 × 30 | 1.80 | 25 × 30 | 1.80 |
| | | | 30 × 25 | 1.70 | 30 × 25 | 1.80 | 30 × 25 | 1.80 |
| 560 | | | 22 × 30 | 1.95 | 22 × 35 | 2.00 | 22 × 40 | 2.00 |
| | | | 25 × 30 | 1.95 | 22 × 40 | 2.00 | 25 × 35 | 2.00 |
| | | | 30 × 25 | 1.90 | 25 × 30 | 1.95 | 30 × 25 | 2.00 |
| | | | | | 30 × 25 | 2.00 | | |
| 680 | | | 22 × 40 | 2.20 | 22 × 45 | 2.25 | 22 × 45 | 2.35 |
| | | | 25 × 30 | 2.20 | 25 × 35 | 2.20 | 25 × 35 | 2.30 |
| | | | 30 × 25 | 2.15 | 30 × 30 | 2.20 | 30 × 30 | 2.30 |
| | | | | | 30 × 25 | 2.20 | 35 × 25 | 2.30 |
| 820 | 22 × 25 | 1.85 | 22 × 45 | 2.50 | 22 × 50 | 2.55 | 25 × 40 | 2.60 |
| | | | 25 × 35 | 2.55 | 25 × 40 | 2.55 | 25 × 45 | 2.60 |
| | | | 30 × 30 | 2.50 | 30 × 30 | 2.60 | 30 × 30 | 2.60 |
| | | | 35 × 25 | 2.50 | 30 × 35 | 2.60 | 30 × 35 | 2.60 |
| | | | | | 35 × 25 | 2.60 | 35 × 30 | 2.60 |
| 1000 | 22 × 30 | 2.10 | 22 × 50 | 2.85 | 25 × 45 | 2.85 | 25 × 45 | 3.00 |
| | 25 × 25 | 2.10 | 25 × 40 | 2.80 | 30 × 35 | 2.85 | 25 × 50 | 3.00 |
| | | | 30 × 35 | 2.80 | 35 × 30 | 2.90 | 30 × 35 | 3.05 |
| | | | 35 × 25 | 2.80 | | | 30 × 40 | 3.05 |
| | | | | | | | 35 × 30 | 3.00 |
| 1200 | 22 × 35 | 2.40 | 25 × 45 | 3.15 | 30 × 40 | 3.25 | 25 × 50 | 3.30 |
| | 25 × 30 | 2.45 | 30 × 35 | 3.15 | 35 × 30 | 3.30 | 30 × 40 | 3.30 |
| | | | 35 × 30 | 3.20 | 35 × 35 | 3.30 | 30 × 45 | 3.30 |
| | | | | | | | 35 × 30 | 3.30 |
| | | | | | | | 35 × 35 | 3.30 |
| 1500 | 22 × 40 | 2.70 | 30 × 45 | 3.75 | 30 × 45 | 3.85 | 30 × 50 | 3.80 |
| | 25 × 30 | 2.75 | 35 × 30 | 3.70 | 35 × 35 | 3.80 | 35 × 40 | 3.80 |
| | 30 × 25 | 2.75 | 35 × 35 | 3.70 | 35 × 40 | 3.80 | | |
| 1800 | 22 × 45 | 3.10 | 30 × 50 | 4.20 | 35 × 40 | 4.30 | 35 × 45 | 4.35 |
| | 25 × 35 | 3.15 | 35 × 40 | 4.20 | 35 × 45 | 4.30 | | |
| | 30 × 30 | 3.15 | | | | | | |
| | 35 × 25 | 3.15 | | | | | | |
| 2200 | 22 × 50 | 3.50 | 35 × 40 | 4.60 | 35 × 45 | 4.90 | 35 × 45 | 4.95 |
| | 25 × 40 | 3.55 | 35 × 45 | 4.80 | 35 × 50 | 4.90 | 35 × 50 | 4.95 |
| | 30 × 30 | 3.55 | | | | | | |
| | 35 × 25 | 3.60 | | | | | | |
| 2700 | 25 × 45 | 4.10 | 35 × 50 | 5.45 | | | | |
| | 30 × 35 | 4.05 | | | | | | |
| | 35 × 25 | 4.05 | | | | | | |
| 3300 | 25 × 50 | 4.50 | | | | | | |
| | 30 × 40 | 4.55 | | | | | | |
| | 35 × 30 | 4.50 | | | | | | |
| 3900 | 30 × 45 | 5.15 | | | | | | |
| | 35 × 35 | 5.10 | | | | | | |
| 4700 | 35 × 40 | 5.75 | | | | | | |
| 5600 | 35 × 50 | 6.20 | | | | | | |

Note : *1. D × L : mm

*2. Ripple Current : (mA r.m.s 85°C / 120Hz)



CASE SIZE OF STANDARD PRODUCTS AND PERMISSIBLE RIPPLE CURRENT

| CAP. (μF) | 250 | | 350 | | 400 | | 450 | |
|-----------|---------|--------|---------|--------|---------|--------|---------|--------|
| | Size | Ripple | Size | Ripple | Size | Ripple | Size | Ripple |
| 47 | | | | | | | 22 × 25 | 0.50 |
| 56 | | | | | 22 × 20 | 0.55 | 25 × 25 | 0.65 |
| 68 | | | 22 × 20 | 0.55 | 22 × 25 | 0.60 | 22 × 30 | 0.70 |
| | | | | | 22 × 20 | 0.60 | 22 × 25 | 0.70 |
| 82 | | | 22 × 25 | 0.65 | 22 × 25 | 0.80 | 22 × 30 | 0.80 |
| | | | 25 × 20 | 0.65 | 25 × 20 | 0.80 | 25 × 25 | 0.80 |
| 100 | | | 22 × 30 | 0.90 | 22 × 30 | 0.90 | 22 × 35 | 0.95 |
| | | | 25 × 20 | 0.90 | 25 × 25 | 0.90 | 25 × 30 | 0.95 |
| | | | | | | | 30 × 25 | 0.95 |
| 120 | 22 × 20 | 0.78 | 22 × 30 | 1.00 | 22 × 35 | 1.05 | 22 × 40 | 1.05 |
| | | | 25 × 25 | 1.00 | 25 × 25 | 1.05 | 25 × 30 | 1.05 |
| | | | | | | | 30 × 25 | 1.05 |
| 150 | 22 × 25 | 0.90 | 22 × 35 | 1.15 | 22 × 35 | 1.15 | 22 × 45 | 1.20 |
| | | | 25 × 30 | 1.15 | 25 × 30 | 1.15 | 25 × 35 | 1.20 |
| | | | 30 × 25 | 1.15 | 30 × 25 | 1.15 | 30 × 30 | 1.20 |
| 180 | 22 × 25 | 1.05 | 22 × 40 | 1.30 | 22 × 45 | 1.30 | 25 × 40 | 1.35 |
| | 25 × 20 | 1.00 | 25 × 30 | 1.25 | 25 × 35 | 1.30 | 30 × 35 | 1.35 |
| | | | 30 × 25 | 1.25 | 30 × 30 | 1.35 | 35 × 25 | 1.35 |
| 220 | 22 × 30 | 1.15 | 22 × 45 | 1.45 | 22 × 50 | 1.50 | 25 × 50 | 1.55 |
| | 22 × 35 | 1.15 | 25 × 35 | 1.45 | 25 × 40 | 1.50 | 30 × 40 | 1.55 |
| | 25 × 25 | 1.15 | 30 × 30 | 1.45 | 30 × 30 | 1.50 | 35 × 30 | 1.55 |
| | | | 35 × 25 | 1.45 | 35 × 25 | 1.50 | | |
| 270 | 22 × 30 | 1.30 | 25 × 40 | 1.65 | 25 × 40 | 1.65 | 30 × 45 | 1.75 |
| | 25 × 25 | 1.30 | 30 × 35 | 1.65 | 30 × 35 | 1.65 | 35 × 35 | 1.70 |
| | | | 35 × 25 | 1.65 | 35 × 30 | 1.65 | | |
| 330 | 22 × 35 | 1.50 | 25 × 50 | 1.80 | 25 × 50 | 1.90 | 30 × 50 | 2.00 |
| | 25 × 25 | 1.50 | 30 × 40 | 1.80 | 30 × 40 | 1.90 | 35 × 40 | 2.00 |
| | 30 × 25 | 1.50 | 35 × 30 | 1.80 | 35 × 30 | 1.85 | | |
| 390 | 22 × 40 | 1.65 | 30 × 40 | 2.00 | 30 × 45 | 2.15 | 35 × 45 | 2.25 |
| | 25 × 35 | 1.65 | 35 × 30 | 2.00 | 35 × 35 | 2.10 | | |
| | 30 × 25 | 1.65 | | | | | | |
| 470 | 22 × 40 | 1.85 | 30 × 45 | 2.25 | 30 × 50 | 2.40 | 35 × 50 | 2.50 |
| | 25 × 35 | 1.85 | 35 × 35 | 2.25 | 35 × 40 | 2.40 | | |
| | 30 × 30 | 1.90 | | | | | | |
| | 35 × 25 | 1.90 | | | | | | |
| 560 | 22 × 45 | 2.10 | 35 × 40 | 2.50 | 35 × 45 | 2.70 | | |
| | 25 × 40 | 2.10 | | | | | | |
| | 30 × 30 | 2.10 | | | | | | |
| | 35 × 25 | 2.10 | | | | | | |
| 680 | 25 × 45 | 2.45 | 35 × 45 | 2.90 | 35 × 50 | 2.90 | 35 × 60 | 2.9 |
| | 30 × 35 | 2.45 | | | | | | |
| | 35 × 30 | 2.45 | | | | | | |
| 820 | 30 × 45 | 2.75 | | | | | | |
| | 35 × 30 | 2.75 | | | | | | |
| 1000 | 30 × 50 | 3.30 | | | | | | |
| | 35 × 40 | 3.30 | | | | | | |
| 1200 | 35 × 40 | 3.55 | | | | | | |
| 1500 | 35 × 45 | 4.05 | | | | | | |

Note : *1. D × L : mm

*2. Ripple Current : (mA r.m.s 85°C / 120Hz)

Miniature Size Aluminum Electrolytic Capacitors

LG [For 105°C, 2000 Hours General]

For Printed Circuit Board High-Performance Aluminum Electrolytic Power Supply Input and Output Filter Capacitors



DESCRIPTION (LG Series 105°C 2000 Hours Assured)

LG type capacitors are combined with snaplock terminals for easy to mount on P.C. Board.

They are ideally suitable to be used in switching power supplies and other industrial or commercial applications.

Multiplier for Ripple Current

Frequency coefficient

| Frequency(Hz) | 50 | 60 | 120 | 1K | 10K~00K |
|---------------|------|------|------|------|---------|
| 6.3~100V | 0.88 | 0.90 | 1.00 | 1.15 | 1.16 |
| 160~250V | 0.85 | 0.88 | 1.00 | 1.15 | 1.20 |
| 315~450V | 0.88 | 0.9 | 1.00 | 1.10 | 1.15 |

Temperature coefficient

| Temperature(°C) | 60 | 70 | 85 | 105 |
|-----------------|------|------|------|------|
| Factor | 2.37 | 2.17 | 1.67 | 1.00 |

DIAGRAM OF DIMENSIONS

Location of P.C.B. Holes



ELECTRICAL CHARACTERISTICS

| | | |
|---|--|---|
| Rated Voltage Range | 6.3 to 100VDC | 160 to 450VDC |
| Operating Temperature Range | -40 to +105°C | -25 to +105°C |
| Capacitance Tolerance | ±20% (At 25°C, 120Hz) | |
| Leakage Current | I = 0.02CV, L = 20m/m, I = 0.03CV or 3mA Whichever is smaller. (At 25°C, After 5 Minutes) | |
| Dissipation Factor (tanδ) | Where, I; Leakage Current (μA) C: Nominal Capacitance (μF) V; Rated Voltage (V) | |
| | Rate Voltage (V) | 6.3 10 16 25 35 50~80 100 160~250 315~450 |
| | D.F (%) | 60 50 40 25 25 20 15 10* 15 |
| | * Note : 15% For D = 35m/m or L = 20m/m (At 25°C, 120Hz) | |
| | (WV = 6.3 ~ 100V For Capacitor Whose Capacitance Exceeds 1000μF) | |
| | The value of D.F (%) is increased by 2% for every addition of 1000μF) | |
| Low Temperature Characteristics (120Hz) | Rated Voltage (V) | 6.3~16 25 35 50~63 80~100 160~400 450 |
| | Z(-25°C) / Z(20°C) | 4 3 3 2 2 4 8 |
| | Z(-40°C) / Z(20°C) | 15 10 8 6 5 - - |
| Load Life | The following specifications shall be satisfied when the capacitors are restored to 25°C after the rated voltage with maximum ripple current is applied for 2000 hours at 105°C. | |
| | Capacitance Change | ≤ ±20% of the Initial Value |
| | D.F | ≤ 200% of the Initial Specified Value |
| | Leakage Current | ≤ the Initial Specified Value |
| Shelf Life | The following specifications shall be satisfied when the capacitor are restored to 25°C after exposing them for 1000 hours at 105°C without voltage applied. | |
| | Capacitance Change | ≤ ±20% of the Initial Value |
| | D.F | ≤ 150% of the Initial Specified Value |
| | Leakage Current | ≤ 150% of Initial Specified Value |

Unit : mm





CASE SIZE OF STANDARD PRODUCTS AND PERMISSIBLE RIPPLE CURRENT

| CAP. (μF) | RATED VOLTAGE WV | | | | | | | |
|-----------|--|------------------------------|--|------------------------------|--|------------------------------|--|------------------------------|
| | 6.3 | | 10 | | 16 | | 25 | |
| | Size | Ripple | Size | Ripple | Size | Ripple | Size | Ripple |
| 4700 | | | | | | | 22 × 25 | 1.50 |
| 5600 | | | | | | | 22 × 30 25 × 25 | 1.65 1.65 |
| 6800 | | | | | 22 × 25 | 1.55 | 22 × 30 25 × 25 | 1.85 1.85 |
| 8200 | | | | | 22 × 30 25 × 25 | 1.70 1.70 | 22 × 35 25 × 30 30 × 25 | 2.10 2.10 2.15 |
| 10000 | | | 25 × 25 | 1.55 | 22 × 30 25 × 25 | 1.95 1.95 | 22 × 40 25 × 35 30 × 30 35 × 25 | 2.40 2.40 2.40 2.40 |
| 12000 | 22 × 25 | 1.55 | 22 × 30 | 1.75 | 22 × 35 25 × 30 30 × 25 | 2.20 2.25 2.30 | 22 × 45 25 × 40 30 × 30 35 × 25 | 2.70 2.75 2.70 2.75 |
| 15000 | 22 × 30 25 × 25 | 1.70 1.70 | 22 × 30 25 × 25 | 1.90 1.90 | 22 × 40 25 × 35 30 × 30 35 × 25 | 2.55 2.60 2.60 2.65 | 25 × 45 30 × 35 35 × 30 | 3.15 3.15 3.25 |
| 18000 | 22 × 30 25 × 25 | 1.95 1.95 | 22 × 35 25 × 30 | 2.20 2.25 | 22 × 45 25 × 40 30 × 30 35 × 25 | 2.90 2.90 2.90 2.95 | 25 × 50 30 × 40 35 × 35 | 3.55 3.55 3.55 |
| 22000 | 22 × 35 25 × 30 30 × 25 | 2.25 2.25 2.25 | 22 × 40 25 × 35 30 × 25 | 2.50 2.55 2.45 | 25 × 45 30 × 35 35 × 30 | 3.30 3.30 3.30 | 30 × 45 35 × 35 | 4.05 3.80 |
| 27000 | 22 × 40 25 × 35 30 × 30 35 × 25 | 2.55 2.55 2.55 2.55 | 22 × 50 25 × 40 30 × 30 35 × 25 | 2.95 2.90 2.85 2.80 | 25 × 50 30 × 40 35 × 30 | 3.80 3.75 3.75 | 35 × 45 | 4.70 |
| 33000 | 22 × 45 25 × 40 30 × 30 35 × 25 | 2.90 2.95 2.90 2.95 | 25 × 45 30 × 35 35 × 30 | 3.30 3.30 3.30 | 30 × 45 35 × 35 | 4.30 4.25 | 35 × 50 | 5.40 |
| 39000 | 25 × 50 30 × 35 35 × 30 | 3.25 3.25 3.30 | 25 × 50 30 × 40 35 × 30 | 3.70 3.70 3.65 | 30 × 50 35 × 40 | 4.80 4.80 | | |
| 47000 | 25 × 50 30 × 40 | 3.70 3.70 | 30 × 45 35 × 35 | 4.20 3.80 | 35 × 45 | 5.45 | | |
| 56000 | 30 × 45 35 × 35 | 4.15 4.10 | 30 × 50 35 × 40 | 4.65 4.65 | | | | |
| 68000 | 30 × 50 35 × 40 | 4.70 4.70 | 35 × 50 | 5.50 | | | | |
| 82000 | 35 × 45 | 5.30 | | | | | | |

Note : *1. D × L : mm

*2. Ripple Current : (mA r.m.s 105°C / 120Hz)



CASE SIZE OF STANDARD PRODUCTS AND PERMISSIBLE RIPPLE CURRENT

| CAP. (μF) | RATED VOLTAGE WV | | | | | | | |
|-----------|--|------------------------------|--|------------------------------|--|------------------------------|--|------------------------------|
| | 35 | | 50 | | 63 | | 80 | |
| | Size | Ripple | Size | Ripple | Size | Ripple | Size | Ripple |
| 820 | | | | | | | 22 × 25 | 1.10 |
| 1000 | | | | | | | 22 × 30 25 × 25 | 1.20 1.20 |
| 1200 | | | | | 22 × 25 | 1.20 | 22 × 30 25 × 25 | 1.40 1.40 |
| 1500 | | | | | 22 × 30 25 × 25 | 1.30 1.30 | 22 × 35 25 × 30 30 × 25 | 1.60 1.60 1.65 |
| 1800 | | | 22 × 25 | 1.30 | 22 × 30 25 × 25 | 1.50 1.50 | 22 × 40 25 × 35 30 × 25 | 1.80 1.85 1.80 |
| 2200 | | | 22 × 30 25 × 25 | 1.55 1.55 | 22 × 35 25 × 30 30 × 25 | 1.70 1.75 1.80 | 22 × 45 25 × 35 30 × 30 35 × 25 | 2.05 2.00 2.05 2.05 |
| 2700 | | | 22 × 30 25 × 25 | 1.70 1.70 | 22 × 40 25 × 35 30 × 25 | 2.00 2.00 1.95 | 25 × 45 30 × 35 35 × 30 | 2.35 2.35 2.35 |
| 3300 | 22 × 25 | 1.40 | 22 × 35 25 × 30 | 1.95 1.85 | 22 × 50 25 × 40 30 × 30 35 × 25 | 2.30 2.30 2.25 2.10 | 25 × 50 30 × 40 35 × 30 | 2.70 2.70 2.55 |
| 3900 | 22 × 30 25 × 25 | 1.55 1.55 | 22 × 40 25 × 35 30 × 25 | 2.15 2.20 1.95 | 25 × 45 30 × 35 35 × 30 | 2.55 2.55 2.55 | 30 × 45 35 × 35 | 3.00 3.00 |
| 4700 | 22 × 35 25 × 25 | 1.80 1.80 | 22 × 45 25 × 40 30 × 30 35 × 25 | 2.45 2.45 2.45 2.50 | 25 × 50 30 × 40 35 × 30 | 2.85 2.85 2.80 | 30 × 50 35 × 40 | 3.40 3.40 |
| 5600 | 22 × 35 25 × 30 30 × 25 | 1.95 1.95 2.00 | 22 × 50 25 × 40 30 × 35 35 × 30 | 2.75 2.70 2.75 2.75 | 30 × 45 35 × 35 | 3.20 3.20 | 35 × 45 | 3.80 |
| 6800 | 22 × 40 25 × 35 30 × 30 35 × 25 | 2.20 2.25 2.30 2.35 | 25 × 50 30 × 40 35 × 30 | 3.30 3.30 3.25 | 30 × 50 35 × 40 | 3.65 3.65 | 35 × 50 | 3.90 |
| 8200 | 22 × 50 25 × 40 30 × 30 35 × 25 | 2.55 2.50 2.75 2.75 | 30 × 45 35 × 35 | 3.60 3.55 | 35 × 45 | 3.90 | | |
| 10000 | 22 × 45 30 × 35 35 × 30 | 2.85 2.90 2.95 | 30 × 50 35 × 40 | 4.50 4.00 | 35 × 50 | 4.40 | | |
| 12000 | 25 × 50 30 × 40 35 × 30 | 3.25 3.25 3.15 | 35 × 45 | 4.55 | | | | |
| 15000 | 30 × 45 35 × 35 | 3.70 3.65 | | | | | | |
| 18000 | 35 × 40 | 4.35 | | | | | | |
| 22000 | 35 × 50 | 4.90 | | | | | | |

Note : *1. D × L : mm

*2. Ripple Current : (mA r.m.s 105°C / 120Hz)



CASE SIZE OF STANDARD PRODUCTS AND PERMISSIBLE RIPPLE CURRENT

| CAP. (μF) | RATED VOLTAGE WV | | | | | | | |
|-----------|--|------------------------------|--|------------------------------|--|--|--|------------------------------|
| | 100 | | 160 | | 180 | | 200 | |
| | Size | Ripple | Size | Ripple | Size | Ripple | Size | Ripple |
| 150 | | | | | | | 22 × 20 | 0.65 |
| 180 | | | | | 22 × 20 | 0.75 | 22 × 20 | 0.70 |
| 220 | | | 22 × 20 | 0.80 | 22 × 25 | 0.85 | 22 × 25 25 × 20 | 0.80 0.80 |
| 270 | | | 22 × 25 | 1.00 | 22 × 25 25 × 20 | 0.95 0.90 | 22 × 25 25 × 25 | 0.85 0.85 |
| 330 | | | 22 × 25 25 × 20 | 1.20 1.15 | 22 × 25 22 × 30 25 × 25 | 1.20 1.10 1.10 | 22 × 30 25 × 25 | 1.20 1.20 |
| 390 | | | 22 × 30 25 × 25 | 1.30 1.30 | 22 × 30 25 × 25 | 1.30 1.30 | 22 × 30 22 × 35 25 × 30 30 × 25 | 1.30 1.30 1.30 1.30 |
| 470 | | | 22 × 30 25 × 25 | 1.30 1.40 | 22 × 30 22 × 35 25 × 30 30 × 25 | 1.30 1.35 1.40 1.40 | 22 × 35 22 × 40 25 × 30 30 × 25 | 1.40 1.40 1.40 1.50 |
| 560 | 22 × 25 | 1.05 | 22 × 40 25 × 30 30 × 25 | 1.50 1.50 1.50 | 22 × 40 25 × 35 30 × 25 | 1.50 1.55 1.50 | 22 × 45 25 × 35 30 × 30 | 1.55 1.55 1.55 |
| 680 | 22 × 25 | 1.20 | 22 × 45 25 × 35 30 × 25 | 1.70 1.70 1.70 | 22 × 45 22 × 50 25 × 35 25 × 40 30 × 30 35 × 25 | 1.70 1.70 1.70 1.75 1.70 1.70 | 22 × 50 25 × 40 30 × 30 35 × 25 | 1.75 1.75 1.75 1.70 |
| 820 | 22 × 30 25 × 25 | 1.30 1.33 | 22 × 50 25 × 40 30 × 30 35 × 25 | 1.95 2.00 2.00 1.90 | 22 × 50 25 × 40 25 × 45 30 × 35 35 × 25 | 1.95 2.00 2.00 2.00 1.90 | 25 × 50 30 × 35 35 × 30 | 2.05 2.00 2.05 |
| 1000 | 22 × 35 25 × 30 | 1.50 1.50 | 25 × 45 30 × 35 35 × 30 | 2.20 2.20 2.20 | 25 × 45 25 × 50 30 × 35 30 × 40 35 × 30 | 2.20 2.20 2.25 2.25 2.25 | 20 × 40 30 × 45 35 × 30 35 × 35 | 2.30 2.30 2.30 2.30 |
| 1200 | 22 × 40 25 × 35 30 × 25 | 1.70 1.70 1.70 | 25 × 50 30 × 40 35 × 30 | 2.45 2.45 2.45 | 25 × 50 30 × 40 30 × 45 35 × 35 | 2.45 2.45 2.50 2.50 | 30 × 50 35 × 40 | 2.60 2.65 |
| 1500 | 22 × 45 25 × 40 30 × 30 35 × 25 | 1.95 2.00 1.95 2.00 | 30 × 45 35 × 35 | 2.80 2.80 | 30 × 45 30 × 50 35 × 40 | 2.80 2.90 2.90 | 35 × 45 | 3.10 |
| 1800 | 25 × 45 30 × 35 35 × 30 | 2.20 2.50 2.45 | 30 × 50 35 × 45 | 3.30 3.30 | 30 × 50 35 × 50 | 3.30 3.30 | 35 × 50 | 3.15 |
| 2200 | 25 × 50 30 × 40 35 × 30 | 2.55 2.70 2.55 | 35 × 50 | 3.75 | 35 × 50 | 3.60 | | |
| 2700 | 30 × 45 35 × 35 | 2.90 2.85 | | | | | | |
| 3300 | 30 × 50 35 × 40 | 3.25 3.25 | | | | | | |
| 3900 | 35 × 40 | 3.70 | | | | | | |
| 4700 | 30 × 50 35 × 50 | 3.80 3.80 | | | | | | |

Note : *1. D × L : mm

*2. Ripple Current : (mA r.m.s 105°C / 120Hz)



CASE SIZE OF STANDARD PRODUCTS AND PERMISSIBLE RIPPLE CURRENT

| CAP. (μF) | RATED VOLTAGE WV | | | | | | | |
|-----------|------------------|--------|---------|--------|---------|--------|---------|--------|
| | 250 | | 350 | | 400 | | 450 | |
| | Size | Ripple | Size | Ripple | Size | Ripple | Size | Ripple |
| 47 | | | | | 22 × 20 | 0.35 | | |
| 56 | | | 22 × 20 | 0.40 | 22 × 20 | 0.40 | 22 × 25 | 0.40 |
| 68 | | | 22 × 25 | 0.45 | 22 × 25 | 0.50 | 22 × 30 | 0.50 |
| | | | | | 25 × 20 | 0.50 | 25 × 25 | 0.50 |
| 82 | | | 22 × 25 | 0.55 | 22 × 30 | 0.60 | 22 × 35 | 0.55 |
| | | | 25 × 20 | 0.50 | 25 × 25 | 0.65 | 25 × 30 | 0.55 |
| | | | | | | | 30 × 25 | 0.55 |
| 100 | | | 22 × 30 | 0.70 | 22 × 35 | 0.65 | 22 × 40 | 0.65 |
| | | | 25 × 25 | 0.70 | 25 × 30 | 0.65 | 25 × 30 | 0.60 |
| 120 | | | | | | | 30 × 25 | 0.65 |
| | 22 × 20 | 0.60 | 22 × 35 | 0.75 | 22 × 35 | 0.70 | 22 × 45 | 0.70 |
| | | | 25 × 30 | 0.75 | 25 × 30 | 0.70 | 25 × 35 | 0.70 |
| | | | 30 × 25 | 0.75 | 30 × 25 | 0.75 | 30 × 30 | 0.70 |
| | | | | | | | 35 × 25 | 0.70 |
| 150 | 22 × 25 | 0.65 | 22 × 40 | 0.80 | 22 × 40 | 0.80 | 22 × 50 | 0.80 |
| | | | 25 × 30 | 0.80 | 25 × 30 | 0.85 | 25 × 40 | 0.80 |
| | | | 30 × 25 | 0.85 | 25 × 35 | 0.85 | 30 × 30 | 0.75 |
| | | | | | 30 × 30 | 0.85 | 35 × 25 | 0.75 |
| | | | | | 35 × 25 | 0.80 | | |
| 180 | 22 × 25 | 0.80 | 22 × 45 | 0.90 | 25 × 50 | 0.95 | 25 × 45 | 0.85 |
| | 25 × 20 | 0.75 | 25 × 35 | 0.90 | 25 × 40 | 0.95 | 30 × 35 | 0.85 |
| | | | 30 × 30 | 0.90 | 30 × 30 | 0.90 | 35 × 30 | 0.85 |
| 220 | 22 × 30 | 0.95 | 22 × 50 | 1.05 | 25 × 45 | 1.05 | 25 × 50 | 1.00 |
| | 25 × 25 | 0.95 | 25 × 40 | 1.05 | 30 × 35 | 1.05 | 30 × 40 | 1.00 |
| | | | 30 × 30 | 1.00 | 35 × 30 | 1.10 | 35 × 30 | 1.00 |
| | | | 35 × 25 | 1.05 | | | | |
| 270 | 22 × 35 | 1.15 | 25 × 45 | 1.20 | 25 × 50 | 1.20 | 30 × 45 | 1.15 |
| | 25 × 30 | 1.15 | 30 × 35 | 1.20 | 30 × 40 | 1.20 | 35 × 35 | 1.15 |
| | 30 × 25 | 1.15 | 35 × 30 | 1.20 | 35 × 35 | 1.20 | | |
| 330 | 22 × 40 | 1.25 | 30 × 40 | 1.35 | 30 × 45 | 1.40 | 30 × 50 | 1.40 |
| | 25 × 30 | 1.20 | 35 × 35 | 1.35 | 35 × 35 | 1.35 | 35 × 40 | 1.40 |
| | 30 × 25 | 1.25 | | | | | | |
| 390 | 22 × 45 | 1.50 | 30 × 45 | 1.50 | 30 × 50 | 1.55 | 35 × 45 | 1.55 |
| | 25 × 35 | 1.50 | 35 × 35 | 1.50 | 35 × 40 | 1.55 | | |
| | 30 × 30 | 1.50 | | | | | | |
| 470 | 22 × 50 | 1.55 | 35 × 40 | 1.70 | 30 × 50 | 1.75 | 35 × 50 | 1.70 |
| | 25 × 40 | 1.55 | | | 35 × 45 | 1.75 | | |
| | 30 × 30 | 1.55 | | | | | | |
| | 35 × 25 | 1.55 | | | | | | |
| 560 | 25 × 45 | 1.80 | 35 × 45 | 1.90 | 30 × 50 | 1.90 | | |
| | 30 × 35 | 1.80 | | | 35 × 45 | 1.90 | | |
| | 35 × 30 | 1.80 | | | | | | |
| 680 | 25 × 50 | 1.95 | | | 35 × 50 | 2.15 | | |
| | 30 × 40 | 2.00 | | | | | | |
| | 35 × 35 | 2.00 | | | | | | |
| 820 | 30 × 45 | 2.15 | | | | | | |
| | 35 × 35 | 2.10 | | | | | | |
| 1000 | 35 × 40 | 2.30 | | | | | | |
| 1500 | 35 × 50 | 3.63 | | | | | | |

Note : *1. D × L : mm

*2. Ripple Current : (mA r.m.s 105°C / 120Hz)

Miniature Size Aluminum Electrolytic Capacitors

LV [For 105°C, 3000 Hours General]

For Printed Circuit Board High-Performance Aluminum Electrolytic Power Supply Input and Output Filter Capacitors



DESCRIPTION (LG Series 105°C 2000 Hours Assured)

LV type capacitors are combined with snaplock terminals for easy to mount on P.C. Board.

Highly reliable capacitors that withstand under high ripple current. Two to Four dimensions with same ratings. Aluminum case designed explosion-proof vent.

Best for switching power supplies.

Multiplier for Ripple Current

Frequency coefficient

| Frequency(Hz) | 60 | 120 | 1K | 10~50K |
|---------------|-----|-----|------|--------|
| 10~100V | 0.9 | 1.0 | 1.15 | 1.25 |
| 160~250V | 0.8 | 1.0 | 1.25 | 1.47 |
| 315~450V | 0.8 | 1.0 | 1.30 | 1.47 |

Temperature coefficient

| Temperature(°C) | 20~45 | 65 | 85 | 105 |
|-----------------|-------|------|------|-----|
| Factor | 2-10 | 1.89 | 1.52 | 1.0 |

DIAGRAM OF DIMENSIONS

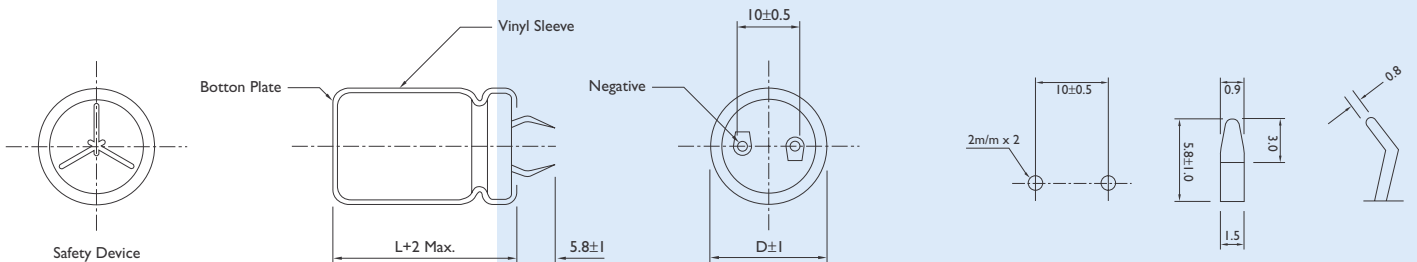

Unit : mm

ELECTRICAL CHARACTERISTICS

| | | |
|---|--|---------------|
| Operating Temperature Range | -40 to +105°C | -25 to +105°C |
| Rated Voltage Range | 10 to 100VDC | 160 to 450VDC |
| Nominal Capacitance Range | 47 to 56000µF | |
| Capacitance Tolerance | ±20% (At 25°C, 120Hz) | |
| Leakage Current | $I = 3\sqrt{CV}$ (µA) after 5 minutes application of rated working voltage at +20°C | |
| Dissipation Factor (tanδ) | Rate Voltage (V) 10 16 25 35 50 63 80 100 160 250 315~450 D.F (%) 55 50 45 40 35 30 25 20 15 15 25 | |
| | For capacitance value > 33000µF, add following calculated value : (rated capacitance) - 33000µF 10000µF × 0.1 | |
| Low Temperature Characteristics (120Hz) | Rated Voltage (V) 16~25 35 50 63~100 160 450 Z(-25°C) / Z(20°C) 6 6 4 3 8 8 Z(-40°C) / Z(20°C) 15 10 8 6 - - | |
| High Temperature Loading | Test conditions After 3000 hours application of rated voltage at +105°C the capacitor shall meet the following limits Post test requirements at +20°C Leakage current : ≤ Initial specified value Capacitance Change : within ±20% of the Initial measured value tan δ : ≤ 200% of initial specified value | |
| Shelf Life | The following specifications shall be satisfied when the capacitor are restored to 25°C after exposing them for 1000 hours at 105°C without voltage applied. Capacitance Change ≤ ±20% of the Initial Value D.F ≤ 200% of the Initial Specified Value Leakage Current ≤ 200% of Initial Specified Value | |



CASE SIZE OF STANDARD PRODUCTS AND PERMISSIBLE RIPPLE CURRENT

| CAP. (μF) | RATED VOLTAGE WV | | | | | | | | | | | |
|-----------|------------------|--------|---------|--------|---------|--------|---------|--------|---------|--------|---------|--------|
| | 10 | | 16 | | 25 | | 35 | | 50 | | 63 | |
| | Size | Ripple | Size | Ripple | Size | Ripple | Size | Ripple | Size | Ripple | Size | Ripple |
| 1000 | | | | | | | | | | | 20 × 25 | 1.10 |
| 1200 | | | | | | | | | | | 20 × 30 | 1.20 |
| | | | | | | | | | | | 22 × 25 | 1.20 |
| 1500 | | | | | | | | | 20 × 25 | 1.15 | 20 × 35 | 1.47 |
| | | | | | | | | | | | 22 × 30 | 1.47 |
| 1800 | | | | | | | | | 20 × 30 | 1.39 | 20 × 35 | 1.58 |
| | | | | | | | | | 22 × 25 | 1.34 | 22 × 30 | 1.58 |
| | | | | | | | | | | | 25 × 25 | 1.52 |
| 2200 | | | | | | | | | 20 × 35 | 1.60 | 20 × 40 | 1.80 |
| | | | | | | | | | 22 × 30 | 1.60 | 22 × 35 | 1.82 |
| | | | | | | | | | | | 25 × 30 | 1.75 |
| 2700 | | | | | | | 20 × 25 | 1.29 | 20 × 35 | 1.73 | 22 × 40 | 2.07 |
| | | | | | | | | | 22 × 30 | 1.70 | 25 × 35 | 2.11 |
| | | | | | | | | | 25 × 25 | 1.70 | 30 × 25 | 1.72 |
| 3300 | | | | | | | 20 × 30 | 1.57 | 20 × 40 | 1.97 | 22 × 45 | 2.33 |
| | | | | | | | 22 × 25 | 1.45 | 22 × 35 | 1.97 | 25 × 35 | 2.27 |
| | | | | | | | | | 25 × 30 | 1.88 | 30 × 30 | 2.24 |
| 3900 | | | | | 20 × 25 | 1.58 | 20 × 35 | 1.78 | 22 × 40 | 2.22 | 25 × 40 | 2.51 |
| | | | | | | | 22 × 30 | 1.69 | 25 × 30 | 2.20 | 30 × 35 | 2.55 |
| | | | | | | | | | 30 × 25 | 1.95 | | |
| 4700 | | | | | 20 × 30 | 1.65 | 20 × 40 | 2.02 | 22 × 45 | 2.43 | 25 × 50 | 2.91 |
| | | | | | 22 × 25 | 1.61 | 22 × 35 | 2.02 | 25 × 35 | 2.43 | 30 × 40 | 2.86 |
| | | | | | | | 25 × 25 | 1.62 | 30 × 30 | 2.25 | 35 × 30 | 2.80 |
| 5600 | | | 20 × 25 | 1.68 | 20 × 35 | 1.85 | 22 × 35 | 2.13 | 22 × 50 | 2.75 | 30 × 40 | 3.22 |
| | | | | | 22 × 30 | 1.80 | 25 × 30 | 2.00 | 25 × 40 | 2.72 | 35 × 35 | 3.20 |
| | | | | | | | | | 30 × 30 | 2.64 | | |
| 6800 | 20 × 25 | 1.31 | 20 × 30 | 1.80 | 20 × 40 | 2.11 | 22 × 40 | 2.41 | 25 × 45 | 3.30 | 30 × 50 | 3.65 |
| | | | 22 × 25 | 1.75 | 22 × 35 | 2.09 | 25 × 35 | 2.31 | 30 × 35 | 3.30 | 35 × 40 | 3.65 |
| | | | | | 25 × 25 | 1.87 | 30 × 25 | 2.31 | 35 × 30 | 3.25 | | |
| 8200 | 20 × 30 | 1.59 | 20 × 35 | 2.08 | 22 × 40 | 2.31 | 22 × 50 | 2.85 | 30 × 40 | 3.60 | 35 × 45 | 4.04 |
| | | | 22 × 30 | 2.00 | 25 × 30 | 2.34 | 25 × 40 | 2.73 | 35 × 35 | 3.60 | | |
| | | | | | 30 × 25 | 2.16 | 30 × 30 | 2.75 | | | | |
| 10000 | 20 × 30 | 1.88 | 20 × 40 | 2.15 | 22 × 45 | 2.65 | 25 × 45 | 3.05 | 30 × 50 | 4.05 | 35 × 50 | 4.48 |
| | 22 × 25 | 1.77 | 22 × 30 | 2.10 | 25 × 35 | 2.61 | 30 × 35 | 3.05 | 35 × 40 | 4.04 | | |
| | | | 25 × 25 | 2.05 | 30 × 30 | 2.61 | | | | | | |
| 12000 | 20 × 35 | 2.18 | 22 × 35 | 2.31 | 22 × 50 | 2.80 | 25 × 50 | 3.37 | 35 × 45 | 4.56 | | |
| | 22 × 30 | 2.10 | 25 × 30 | 2.30 | 25 × 40 | 2.81 | 30 × 40 | 3.23 | | | | |
| | 25 × 25 | 1.94 | | | 30 × 30 | 2.74 | 35 × 30 | 3.19 | | | | |
| 15000 | 20 × 40 | 2.27 | 22 × 40 | 2.68 | 25 × 45 | 3.27 | 30 × 45 | 3.72 | 35 × 50 | 4.77 | | |
| | 22 × 35 | 2.23 | 25 × 35 | 2.58 | 30 × 35 | 3.13 | 35 × 35 | 3.67 | | | | |
| | 25 × 30 | 2.10 | 30 × 25 | 2.30 | 35 × 30 | 3.26 | | | | | | |
| 18000 | 22 × 40 | 2.41 | 22 × 50 | 3.20 | 30 × 40 | 3.56 | 35 × 40 | 4.37 | | | | |
| | 25 × 30 | 2.34 | 25 × 40 | 3.16 | 35 × 35 | 3.84 | | | | | | |
| | 30 × 25 | 2.25 | 30 × 30 | 2.57 | | | | | | | | |
| 22000 | 22 × 45 | 2.58 | 25 × 45 | 3.36 | 30 × 45 | 4.04 | 35 × 45 | 4.92 | | | | |
| | 25 × 35 | 2.54 | 30 × 30 | 2.98 | 35 × 35 | 3.75 | | | | | | |
| | 30 × 30 | 2.50 | 35 × 30 | 3.25 | | | | | | | | |
| 27000 | 22 × 50 | 3.17 | 25 × 50 | 3.85 | 35 × 45 | 4.74 | | | | | | |
| | 25 × 40 | 3.07 | 30 × 35 | 3.30 | | | | | | | | |
| | 30 × 30 | 2.95 | 35 × 35 | 3.93 | | | | | | | | |
| 33000 | 25 × 45 | 3.39 | 30 × 40 | 3.80 | 35 × 50 | 5.50 | | | | | | |
| | 30 × 35 | 3.33 | 35 × 35 | 4.27 | | | | | | | | |
| | 35 × 30 | 3.21 | | | | | | | | | | |
| 39000 | 30 × 40 | 3.70 | 30 × 45 | 4.30 | | | | | | | | |
| | 35 × 35 | 3.68 | 35 × 40 | 4.80 | | | | | | | | |
| 47000 | 30 × 45 | 4.22 | 30 × 50 | 4.81 | | | | | | | | |
| | 35 × 40 | 4.16 | 35 × 45 | 5.53 | | | | | | | | |
| 56000 | 35 × 50 | 5.00 | | | | | | | | | | |

Note : *1. D × L : mm

*2. Ripple Current : (mA r.m.s 105°C / 120Hz)



CASE SIZE OF STANDARD PRODUCTS AND PERMISSIBLE RIPPLE CURRENT

| CAP. (μF) | RATED VOLTAGE WV | | | | | | | | | | | |
|-----------|------------------|--------|---------|--------|---------|--------|---------|--------|---------|--------|---------|--------|
| | 80 | | 100 | | 160 | | 180 | | 200 | | 220 | |
| | Size | Ripple | Size | Ripple | Size | Ripple | Size | Ripple | Size | Ripple | Size | Ripple |
| 180 | | | | | | | | | | | 20 × 25 | 0.81 |
| 220 | | | | | | | 20 × 25 | 0.81 | 20 × 25 | 0.83 | 20 × 30 | 0.94 |
| | | | | | | | | | | | 22 × 25 | 0.94 |
| 270 | | | | | 20 × 25 | 0.87 | 20 × 30 | 0.95 | 20 × 30 | 0.97 | 20 × 35 | 1.10 |
| | | | | | | | 22 × 25 | 0.97 | 22 × 25 | 0.99 | 22 × 30 | 1.09 |
| 330 | | | | | 20 × 30 | 1.02 | 20 × 35 | 1.09 | 20 × 35 | 1.17 | 20 × 40 | 1.18 |
| | | | | | 22 × 25 | 1.03 | 22 × 30 | 1.13 | 22 × 30 | 1.20 | 22 × 35 | 1.24 |
| | | | | | | | | | 25 × 25 | 1.20 | 25 × 25 | 1.14 |
| 390 | | | | | 20 × 35 | 1.15 | 20 × 35 | 1.28 | 20 × 40 | 1.27 | 20 × 45 | 1.33 |
| | | | | | 22 × 30 | 1.17 | 22 × 30 | 1.32 | 22 × 35 | 1.30 | 22 × 35 | 1.30 |
| | | | | | | | 25 × 25 | 1.33 | 25 × 30 | 1.34 | 25 × 25 | 1.26 |
| 470 | | | | | 20 × 40 | 1.25 | 22 × 40 | 1.34 | 22 × 40 | 1.44 | 22 × 40 | 1.41 |
| | | | | | 22 × 30 | 1.28 | 22 × 35 | 1.39 | 25 × 30 | 1.44 | 25 × 30 | 1.39 |
| | | | | | 25 × 25 | 1.29 | 25 × 30 | 1.43 | 30 × 25 | 1.48 | 30 × 25 | 1.37 |
| 560 | | | 20 × 25 | 0.95 | 22 × 35 | 1.45 | 22 × 40 | 1.56 | 22 × 45 | 1.60 | 22 × 45 | 1.60 |
| | | | | | 25 × 30 | 1.49 | 25 × 30 | 1.53 | 25 × 35 | 1.60 | 25 × 35 | 1.56 |
| | | | | | | | 30 × 25 | 1.56 | 30 × 30 | 1.60 | 30 × 30 | 1.61 |
| | | | | | | | | | | | 35 × 25 | 1.52 |
| 680 | | | 20 × 30 | 1.15 | 22 × 40 | 1.64 | 22 × 45 | 1.76 | 22 × 50 | 1.75 | 25 × 40 | 1.75 |
| | | | 22 × 25 | 1.09 | 25 × 35 | 1.70 | 25 × 35 | 1.76 | 25 × 40 | 1.76 | 30 × 35 | 1.76 |
| | | | | | 30 × 25 | 1.63 | 30 × 30 | 1.74 | 30 × 30 | 1.74 | 35 × 30 | 1.72 |
| 820 | 20 × 25 | 1.04 | 20 × 35 | 1.31 | 22 × 45 | 1.85 | 22 × 50 | 1.97 | 25 × 45 | 2.10 | 25 × 45 | 1.97 |
| | | | 22 × 30 | 1.32 | 25 × 40 | 1.92 | 25 × 40 | 1.99 | 30 × 35 | 2.11 | 30 × 40 | 2.06 |
| | | | | | 30 × 30 | 1.91 | 30 × 30 | 1.93 | 35 × 30 | 2.10 | 35 × 30 | 1.95 |
| 1000 | 20 × 30 | 1.24 | 20 × 35 | 1.43 | 25 × 45 | 2.17 | 25 × 45 | 2.24 | 25 × 50 | 2.36 | 30 × 45 | 2.44 |
| | 22 × 25 | 1.19 | 22 × 30 | 1.47 | 30 × 35 | 2.19 | 30 × 35 | 2.24 | 30 × 40 | 2.40 | 35 × 35 | 2.20 |
| | | | 25 × 25 | 1.45 | | | 35 × 30 | 2.20 | 35 × 35 | 2.30 | | |
| 1200 | 20 × 35 | 1.43 | 20 × 40 | 1.61 | 25 × 50 | 2.43 | 30 × 40 | 2.53 | 30 × 45 | 2.69 | 35 × 40 | 2.37 |
| | 22 × 30 | 1.44 | 22 × 35 | 1.69 | 30 × 40 | 2.48 | 35 × 35 | 2.54 | 35 × 35 | 2.53 | | |
| | | | 25 × 30 | 1.68 | 35 × 30 | 2.25 | | | | | | |
| 1500 | 20 × 35 | 1.57 | 22 × 40 | 1.97 | 30 × 45 | 2.82 | 30 × 50 | 3.03 | 35 × 40 | 2.97 | 35 × 45 | 2.64 |
| | 22 × 30 | 1.59 | 25 × 35 | 1.98 | 35 × 35 | 2.62 | 35 × 40 | 2.91 | | | | |
| | 25 × 25 | 1.59 | 30 × 25 | 1.95 | | | | | | | | |
| 1800 | 20 × 40 | 1.77 | 22 × 45 | 2.23 | 30 × 50 | 3.13 | 35 × 45 | 3.25 | 35 × 45 | 3.45 | | |
| | 22 × 35 | 1.79 | 25 × 40 | 2.20 | 35 × 40 | 2.97 | | | | | | |
| | 25 × 30 | 1.71 | 30 × 30 | 2.20 | | | | | | | | |
| 2200 | 22 × 40 | 2.03 | 25 × 45 | 2.53 | 35 × 45 | 3.34 | 35 × 50 | 3.62 | | | | |
| | 25 × 35 | 1.98 | 30 × 35 | 2.55 | | | | | | | | |
| | 30 × 25 | 1.98 | 35 × 30 | 2.50 | | | | | | | | |
| 2700 | 22 × 45 | 2.39 | 25 × 50 | 2.82 | | | | | | | | |
| | 25 × 40 | 2.35 | 30 × 40 | 2.86 | | | | | | | | |
| | 30 × 30 | 2.35 | 35 × 35 | 2.89 | | | | | | | | |
| 3300 | 25 × 45 | 2.64 | 30 × 45 | 3.30 | | | | | | | | |
| | 30 × 35 | 2.61 | 35 × 35 | 3.25 | | | | | | | | |
| | 35 × 30 | 2.47 | | | | | | | | | | |
| 3900 | 25 × 50 | 2.92 | 30 × 50 | 3.60 | | | | | | | | |
| | 30 × 40 | 2.82 | 35 × 40 | 3.67 | | | | | | | | |
| | 35 × 30 | 2.97 | | | | | | | | | | |
| 4700 | 30 × 45 | 3.34 | 35 × 45 | 3.80 | | | | | | | | |
| | 35 × 35 | 3.38 | | | | | | | | | | |
| 5600 | 30 × 50 | 3.80 | 35 × 50 | 4.05 | | | | | | | | |
| | 35 × 40 | 3.80 | | | | | | | | | | |
| 6800 | 35 × 45 | 3.90 | | | | | | | | | | |
| 8200 | 35 × 50 | 4.20 | | | | | | | | | | |

Note : *1. D × L : mm

*2. Ripple Current : (mA r.m.s 105°C / 120Hz)



CASE SIZE OF STANDARD PRODUCTS AND PERMISSIBLE RIPPLE CURRENT

| CAP. (μF) | RATED VOLTAGE WV | | | | | | | | | | | | | |
|-----------|------------------|--------|---------|--------|---------|--------|---------|--------|---------|--------|---------|--------|---------|--------|
| | 250 | | 315 | | 350 | | 385 | | 400 | | 420 | | 450 | |
| | Size | Ripple | Size | Ripple | Size | Ripple | Size | Ripple | Size | Ripple | Size | Ripple | Size | Ripple |
| 47 | | | | | | | | | | | | | 20 × 25 | 0.36 |
| 56 | | | | | | | 20 × 25 | 0.37 | 20 × 25 | 0.40 | 20 × 25 | 0.40 | 20 × 30 | 0.41 |
| | | | | | | | 22 × 25 | 0.42 | | | | | 22 × 25 | 0.42 |
| 68 | | | | | 20 × 25 | 0.41 | 20 × 30 | 0.44 | 20 × 30 | 0.48 | 20 × 30 | 0.48 | 20 × 35 | 0.47 |
| | | | | | | | 22 × 25 | 0.45 | 22 × 25 | 0.49 | 22 × 25 | 0.50 | 22 × 30 | 0.50 |
| | | | | | | | | | | | | | 25 × 25 | 0.50 |
| 82 | | | 20 × 25 | 0.39 | 20 × 30 | 0.45 | 20 × 30 | 0.50 | 20 × 30 | 0.54 | 20 × 35 | 0.53 | 20 × 40 | 0.53 |
| | | | | | | | 22 × 30 | 0.52 | 22 × 30 | 0.56 | 22 × 30 | 0.56 | 22 × 35 | 0.56 |
| | | | | | | | | | | | 25 × 25 | 0.56 | 25 × 30 | 0.57 |
| 100 | | | 20 × 30 | 0.45 | 20 × 30 | 0.51 | 20 × 35 | 0.56 | 20 × 35 | 0.60 | 20 × 35 | 0.58 | 22 × 40 | 0.64 |
| | | | | | 22 × 25 | 0.53 | 22 × 30 | 0.58 | 22 × 30 | 0.62 | 22 × 30 | 0.63 | 25 × 30 | 0.63 |
| | | | | | | | 25 × 25 | 0.57 | 25 × 25 | 0.61 | 25 × 25 | 0.63 | 30 × 25 | 0.67 |
| 120 | | | 20 × 30 | 0.54 | 20 × 35 | 0.59 | 20 × 40 | 0.66 | 20 × 40 | 0.71 | 20 × 45 | 0.71 | 22 × 45 | 0.72 |
| | | | 22 × 25 | 0.56 | 22 × 30 | 0.61 | 22 × 35 | 0.68 | 22 × 35 | 0.73 | 22 × 35 | 0.73 | 25 × 35 | 0.71 |
| | | | | | 25 × 25 | 0.62 | 25 × 30 | 0.68 | 25 × 30 | 0.73 | 25 × 30 | 0.72 | 30 × 30 | 0.77 |
| | | | | | | | | | | | 30 × 25 | 0.75 | | |
| 150 | 20 × 25 | 0.71 | 20 × 35 | 0.64 | 20 × 40 | 0.70 | 22 × 40 | 0.79 | 22 × 40 | 0.85 | 22 × 45 | 0.86 | 22 × 50 | 0.80 |
| | | | 22 × 30 | 0.66 | 22 × 35 | 0.73 | 25 × 30 | 0.78 | 25 × 35 | 0.85 | 25 × 35 | 0.83 | 25 × 40 | 0.82 |
| | | | 25 × 25 | 0.65 | 25 × 30 | 0.73 | 30 × 25 | 0.75 | 30 × 25 | 0.79 | 30 × 25 | 0.83 | 30 × 30 | 0.85 |
| 180 | 20 × 30 | 0.82 | 20 × 40 | 0.75 | 22 × 40 | 0.83 | 22 × 45 | 0.89 | 22 × 45 | 0.95 | 22 × 50 | 1.02 | 25 × 45 | 0.93 |
| | 22 × 25 | 0.84 | 22 × 35 | 0.78 | 25 × 30 | 0.80 | 25 × 35 | 0.86 | 25 × 35 | 0.92 | 25 × 40 | 0.94 | 30 × 35 | 0.97 |
| | | | 25 × 30 | 0.71 | 30 × 25 | 0.81 | 30 × 30 | 0.88 | 30 × 30 | 0.95 | 30 × 30 | 0.95 | | |
| | | | | | | | | | | | 35 × 25 | 0.90 | | |
| 220 | 20 × 35 | 0.95 | 22 × 40 | 0.89 | 22 × 45 | 0.94 | 22 × 50 | 1.01 | 22 × 50 | 1.08 | 25 × 45 | 1.13 | 25 × 50 | 1.05 |
| | 22 × 30 | 0.97 | 25 × 30 | 0.85 | 25 × 35 | 0.92 | 25 × 40 | 1.00 | 25 × 40 | 1.05 | 30 × 35 | 1.09 | 30 × 40 | 1.10 |
| | 25 × 25 | 0.99 | 30 × 25 | 0.83 | 30 × 30 | 0.98 | 30 × 30 | 1.00 | 30 × 35 | 1.24 | 35 × 30 | 1.05 | 35 × 30 | 1.01 |
| 270 | 20 × 40 | 1.08 | 22 × 45 | 1.01 | 22 × 50 | 1.07 | 25 × 45 | 1.13 | 25 × 50 | 1.29 | 25 × 50 | 1.37 | 30 × 45 | 1.25 |
| | 22 × 35 | 1.11 | 25 × 35 | 0.98 | 25 × 40 | 1.05 | 30 × 40 | 1.14 | 30 × 40 | 1.30 | 30 × 40 | 1.25 | 35 × 35 | 1.26 |
| | 25 × 30 | 1.15 | 30 × 30 | 1.01 | 30 × 30 | 1.03 | 35 × 30 | 1.10 | 35 × 30 | 1.18 | 35 × 35 | 1.25 | | |
| 330 | 22 × 40 | 1.26 | 22 × 50 | 1.14 | 25 × 45 | 1.24 | 30 × 45 | 1.31 | 30 × 45 | 1.47 | 30 × 45 | 1.49 | 30 × 50 | 1.42 |
| | 25 × 30 | 1.26 | 25 × 40 | 1.12 | 30 × 35 | 1.24 | 35 × 35 | 1.32 | 35 × 35 | 1.41 | 35 × 35 | 1.42 | 35 × 40 | 1.44 |
| | 30 × 25 | 1.31 | 30 × 35 | 1.21 | 35 × 30 | 1.18 | | | | | | | | |
| 390 | 22 × 45 | 1.41 | 25 × 45 | 1.31 | 25 × 50 | 1.38 | 30 × 50 | 1.48 | 30 × 50 | 1.64 | 30 × 50 | 1.67 | 35 × 45 | 1.61 |
| | 25 × 35 | 1.42 | 30 × 35 | 1.30 | 30 × 40 | 1.39 | 35 × 40 | 1.48 | 35 × 40 | 1.59 | 35 × 40 | 1.61 | | |
| | 30 × 30 | 1.50 | 35 × 30 | 1.23 | 35 × 35 | 1.39 | | | | | | | | |
| 470 | 22 × 50 | 1.58 | 30 × 40 | 1.53 | 30 × 45 | 1.57 | 35 × 45 | 1.76 | 35 × 45 | 1.87 | 35 × 45 | 1.86 | 35 × 45 | 1.80 |
| | 25 × 40 | 1.61 | 35 × 35 | 1.47 | 35 × 35 | 1.50 | | | | | | | | |
| | 30 × 30 | 1.61 | | | | | | | | | | | | |
| 560 | 25 × 45 | 1.80 | 30 × 45 | 1.65 | 30 × 50 | 1.75 | 35 × 50 | 1.95 | 35 × 50 | 2.09 | | | | |
| | 30 × 35 | 1.84 | 35 × 40 | 1.66 | 35 × 40 | 1.69 | | | | | | | | |
| 680 | 25 × 50 | 2.03 | 35 × 45 | 1.96 | 35 × 45 | 1.96 | | | | | | | | |
| | 30 × 40 | 2.09 | | | | | | | | | | | | |
| | 35 × 30 | 1.96 | | | | | | | | | | | | |
| 820 | 30 × 45 | 2.35 | 35 × 50 | 2.19 | | | | | | | | | | |
| | 35 × 35 | 2.26 | | | | | | | | | | | | |
| 1000 | 30 × 50 | 2.64 | | | | | | | | | | | | |
| | 35 × 40 | 2.57 | | | | | | | | | | | | |
| 1200 | 30 × 45 | 2.88 | | | | | | | | | | | | |

Note : *1. D × L : mm

*2. Ripple Current : (mA r.m.s 105°C / 120Hz)

Surface Mount Aluminum Electrolytic

CA Series

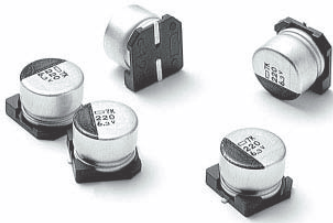

FEATURE

For General Purposes Series with 85°C 2000 Hours

Suitable for AV (TV, Video, Audio), Personal Computer, Home Appliance

MARKING



DIMENSIONS

Unit : mm



| SIZE CODE | DØ | L | A | H | I | W | P | K |
|-----------|------|------|------|-----------|-----|------------|-----|--|
| B | 4.0 | 5.4 | 4.3 | 5.5 Max. | 1.8 | 0.65 ± 0.1 | 1.0 | 0.35 ^{+0.15} _{-0.20} |
| C | 5.0 | 5.4 | 5.3 | 6.5 Max. | 2.2 | 0.65 ± 0.1 | 1.5 | 0.35 ^{+0.15} _{-0.20} |
| D | 6.3 | 5.4 | 6.6 | 7.8 Max. | 2.6 | 0.65 ± 0.1 | 2.2 | 0.35 ^{+0.15} _{-0.20} |
| E | 8.0 | 6.5 | 8.3 | 9.4 Max. | 3.4 | 0.65 ± 0.1 | 2.2 | 0.35 ^{+0.15} _{-0.20} |
| F | 8.0 | 10.5 | 8.3 | 10.0 Max. | 3.4 | 0.90 ± 0.2 | 3.1 | 0.70 ± 0.20 |
| G | 10.0 | 10.5 | 10.3 | 12.0 Max. | 3.5 | 0.90 ± 0.2 | 4.6 | 0.70 ± 0.20 |
| H | 6.3 | 7.7 | 6.6 | 0.8 Max. | 2.6 | 0.65 ± 0.1 | 2.2 | 0.35 ^{+0.15} _{-0.20} |

Surface Mount Aluminum Electrolytic

CB Series

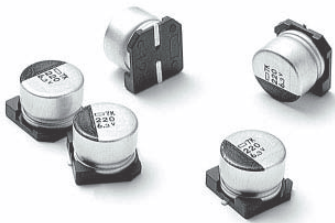

FEATURE

For General Purposes Series with 105°C 1000 Hours

Suitable for AV (TV, Video, Audio), Personal Computer, Home Appliance

MARKING



DIMENSIONS

Unit : mm



| SIZE CODE | DØ | L | A | H | I | W | P | K |
|-----------|------|------|------|-----------|-----|------------|-----|--|
| B | 4.0 | 5.4 | 4.3 | 5.5 Max. | 1.8 | 0.65 ± 0.1 | 1.0 | 0.35 ^{+0.15} _{-0.20} |
| C | 5.0 | 5.4 | 5.3 | 6.5 Max. | 2.2 | 0.65 ± 0.1 | 1.5 | 0.35 ^{+0.15} _{-0.20} |
| D | 6.3 | 5.4 | 6.6 | 7.8 Max. | 2.6 | 0.65 ± 0.1 | 2.2 | 0.35 ^{+0.15} _{-0.20} |
| E | 8.0 | 6.5 | 8.3 | 9.5 Max. | 3.4 | 0.65 ± 0.1 | 2.2 | 0.35 ^{+0.15} _{-0.20} |
| F | 8.0 | 10.5 | 8.3 | 10.0 Max. | 3.4 | 0.90 ± 0.2 | 3.1 | 0.70 ± 0.20 |
| G | 10.0 | 10.5 | 10.3 | 12.0 Max. | 3.5 | 0.90 ± 0.2 | 4.6 | 0.70 ± 0.20 |
| H | 6.3 | 7.7 | 6.6 | 0.8 Max. | 2.6 | 0.65 ± 0.1 | 2.2 | 0.35 ^{+0.15} _{-0.20} |



SPECIFICATION

| ITEM | CHARACTERISTIC | | | | | | | | | | | | | | | | | | | | | | | | |
|--|--|--------|----|-----|----|----|----|----|----|-------------------|----|----|----|----|----|----|----|-------------------|----|---|---|---|---|---|---|
| Operation Temperature Range | -40 to +105°C | | | | | | | | | | | | | | | | | | | | | | | | |
| Rated Working Voltage Range | 4 to 50V. DC | | | | | | | | | | | | | | | | | | | | | | | | |
| Rated Capacitance | Range = 0.1 ~ 1000μF | | | | | | | | | | | | | | | | | | | | | | | | |
| Capacitance Tolerance | ±20% (120Hz / +25°C) | | | | | | | | | | | | | | | | | | | | | | | | |
| Leakage Current (25°C) | Polarized : $I \leq 0.01CV$ or 3 (μA) Whichever is greater after 2 minutes application of DC rated working voltage at 25°C. I : Leakage Current (μA) C : Rated Capacitance (μF) V : Working Voltage (V) | | | | | | | | | | | | | | | | | | | | | | | | |
| Dissipation Factor (tanδ) (120Hz / +25°C) | Polarized () : D.F. of Downsized <table border="1"> <thead> <tr> <th>WV (V)</th> <th>4</th> <th>6.3</th> <th>10</th> <th>16</th> <th>25</th> <th>35</th> <th>50</th> </tr> </thead> <tbody> <tr> <td>D.F.</td> <td>35</td> <td>28</td> <td>24</td> <td>20</td> <td>16</td> <td>14</td> <td>12</td> </tr> </tbody> </table> | WV (V) | 4 | 6.3 | 10 | 16 | 25 | 35 | 50 | D.F. | 35 | 28 | 24 | 20 | 16 | 14 | 12 | | | | | | | | |
| WV (V) | 4 | 6.3 | 10 | 16 | 25 | 35 | 50 | | | | | | | | | | | | | | | | | | |
| D.F. | 35 | 28 | 24 | 20 | 16 | 14 | 12 | | | | | | | | | | | | | | | | | | |
| Low Temperature Stability | Impedance Ratio at 120Hz <table border="1"> <thead> <tr> <th>WV (V)</th> <th>4</th> <th>6.3</th> <th>10</th> <th>16</th> <th>25</th> <th>35</th> <th>50</th> </tr> </thead> <tbody> <tr> <td>Z(-25°C)/Z(+20°C)</td> <td>7</td> <td>4</td> <td>3</td> <td>2</td> <td>2</td> <td>2</td> <td>2</td> </tr> <tr> <td>Z(-40°C)/Z(+20°C)</td> <td>15</td> <td>8</td> <td>6</td> <td>4</td> <td>4</td> <td>3</td> <td>3</td> </tr> </tbody> </table> | WV (V) | 4 | 6.3 | 10 | 16 | 25 | 35 | 50 | Z(-25°C)/Z(+20°C) | 7 | 4 | 3 | 2 | 2 | 2 | 2 | Z(-40°C)/Z(+20°C) | 15 | 8 | 6 | 4 | 4 | 3 | 3 |
| WV (V) | 4 | 6.3 | 10 | 16 | 25 | 35 | 50 | | | | | | | | | | | | | | | | | | |
| Z(-25°C)/Z(+20°C) | 7 | 4 | 3 | 2 | 2 | 2 | 2 | | | | | | | | | | | | | | | | | | |
| Z(-40°C)/Z(+20°C) | 15 | 8 | 6 | 4 | 4 | 3 | 3 | | | | | | | | | | | | | | | | | | |
| Load Life | After 1000 hours application of WV at 105°C, the capacitor shall meet following limits. Capacitance Change ≤ ±20% of Initial Value Dissipation Factor ≤ 200% of Initial Specified Value Leakage Current ≤ Initial Specified Value | | | | | | | | | | | | | | | | | | | | | | | | |
| Shelf Life | At +105°C no voltage application after 1000 hours and then through the aging treatment, the capacitor shall meet limits for load life characteristics. | | | | | | | | | | | | | | | | | | | | | | | | |

CASE SIZE & MAX RIPPLE CURRENT

Max. Ripple Current (mA) r.m.s. (120Hz / +85°C)

POLARIZED

| μF | 4 | 6.3 | 10 | 16 | 25 | 35 | 50 |
|------|------------------|------------------|------------------|------------------|--------------------|------------------|------------------|
| 0.1 | | | | | | | 4 × 5.4 0.7 |
| 0.22 | | | | | | | 4 × 5.4 1.6 |
| 0.33 | | | | | | | 4 × 5.4 2.5 |
| 0.47 | | | | | | | 4 × 5.4 3.5 |
| 1.0 | | | | | | | 4 × 5.4 4 |
| 2.2 | | | | | | | 4 × 5.4 11 |
| 3.3 | | | | | | 4 × 5.4 13 | 4 × 5.4 13 |
| 4.7 | | | | | 4 × 5.4 13 | 4 × 5.4 14 | 5 × 5.4 16 |
| 10 | | | | | 4 × 5.4 13 | 4 × 5.4 21 | 6.3 × 5.4 24 |
| | | | | 4 × 5.4 18 | 5 × 5.4 20 | | |
| 22 | | 4 × 5.4 22 | 4 × 5.4 22 | 4 × 5.4 18 | 6.3 × 5.4 36 | 5 × 5.4 38 | 6.3 × 7.7 51 |
| | | | 4 × 5.4 25 | 5 × 5.4 37 | | | |
| 33 | 4 × 5.4 18 | 5 × 5.4 27 | 5 × 5.4 30 | 6.3 × 5.4 40 | 6.3 × 5.4 44 | 6.3 × 5.4 42 | 6.3 × 7.7 60 |
| 47 | 4 × 5.4 23 | 5 × 5.4 33 | 6.3 × 5.4 41 | 6.3 × 5.4 48 | 6.3 × 5.4 48 | 6.3 × 7.7 49 | 6.3 × 7.7 63 |
| 100 | 5 × 5.4 42 | 6.3 × 5.4 50 | 6.3 × 5.4 53 | 6.3 × 5.4 60 | 6.3 × 7.7 91 | 8 × 10.5 155 | 8 × 10.5 155 |
| 150 | 6.3 × 5.4 61 | 6.3 × 5.4 55 | 6.3 × 5.4 62 | 6.3 × 7.7 95 | 8 × 10.5 140 | 8 × 10.5 155 | 10 × 10.5 300 |
| 220 | 6.3 × 5.4 68 | 6.3 × 7.7 105 | 6.3 × 7.7 105 | 6.3 × 7.7 105 | 8 × 10.5 175 | 10 × 10.5 300 | |
| 330 | 6.3 × 7.7 73 | 6.3 × 7.7 105 | 8 × 10.5 175 | 8 × 10.5 195 | 10.5 × 10.5 220 | | |
| 470 | 6.3 × 7.7 105 | 8 × 10.5 170 | 8 × 10.5 210 | 8 × 10.5 310 | | | |
| 680 | 8 × 10.5 210 | 8 × 10.5 210 | 10 × 10.5 230 | 10 × 10.5 350 | | | |
| 1000 | 8 × 10.5 260 | 10 × 10.5 230 | | | | | |