

YAGEO

**Product Selection Tables
2005**

MLCC

Yageo brand



YAGEO



Table of Contents

Table of contents	
MLCC - NP0 / Yageo brand	2
NP0, 16V, general purpose	2
NP0, 25V, general purpose	3
NP0, 50V, general purpose	4
NP0, 100V, general purpose	6
NP0, 200V and 500V, medium voltage	7
MLCC - X7R / Yageo brand	8
X7R, 10V, general purpose	8
X7R, 16V and 25V, general purpose	9
X7R, 50V and 100V, general purpose	10
X7R, 200V, 250V and 500V, medium voltage	11
MLCC - Y5V / Yageo brand	12
Y5V, 10V to 50V, general purpose	12
General information	13
Ordering and packing	13
Yageo - A Global Company	15
Contact information	15

MLCC - NP0 / Yageo brand

NP0, 16V, general purpose

NP0 - 16V			
General purpose			
Capacitance	Last 3 digits of Yageo part number	16V	
		0402	0603
270 pF	271	0.5 ±0.05	
330 pF	331		
390 pF	391		
470 pF	471		
1.8 nF	182		0.8 ±0.07
2.2 nF	222		
2.7 nF	272		
3.3 nF	332		
Tape width		8mm	

Note: Values in shaded cells indicate thickness class (Unit: mm)

MLCC - NP0 / Yageo brand

NP0, 25V, general purpose

NP0 - 25V					
General purpose					
Capacitance	Last 3 digits of Yageo part number	25V			
		0603	0805	1206	1210
820 pF	821	0.8 ±0.07			
1000 pF	102				
1.2 nF	122				
1.5 nF	152				
3.3 nF	332		0.85 ±0.1		
3.9 nF	392		1.25 ±0.1		
4.7 nF	472				
8.2 nF	822			0.85 ±0.1	
10 nF	103				
12 nF	123				0.6 ±0.1
15 nF	153				0.85 ±0.1
18 nF	183				
22 nF	223				1.15 ±0.15
Tape width		8mm			

Note: Values in shaded cells indicate thickness class (Unit: mm)

MLCC - NP0 / Yageo brand

NP0, 50V, general purpose

NP0 - 50V							
General purpose							
Capacitance	Last 3 digits of Yageo part number	50V					
		0402	0603	0805	1206	1210	1812
0.47 pF	R47	0.5 ±0.05	0.8 ±0.07	0.6 ±0.1	0.6 ±0.1		
0.56 pF	R56						
0.68 pF	R68						
0.82 pF	R82						
1 pF	1R0						
1.2 pF	1R2						
1.5 pF	1R5						
1.8 pF	1R8						
2.2 pF	2R2						
2.7 pF	2R7						
3.3 pF	3R3						
3.9 pF	3R9						
4.7 pF	4R7						
5.6 pF	5R6						
6.8 pF	6R8						
8.2 pF	8R2						
10 pF	100						
12 pF	120						
15 pF	150						
18 pF	180						
22 pF	220						
27 pF	270						
33 pF	330						
39 pF	390						
47 pF	470					0.6 ±0.1	
56 pF	560						
68 pF	680						
82 pF	820						
100 pF	101						
120 pF	121						
150 pF	151						
180 pF	181						
220 pF	221						
270 pF	271						
330 pF	331						0.6 ±0.1
390 pF	391						
470 pF	471						
560 pF	561						
680 pF	681						
820 pF	821						
1000 pF	102						
1.2 nF	122			0.85 ±0.1			
1.5 nF	152						
1.8 nF	182						
2.2 nF	222			1.25 ±0.1			
2.7 nF	272						
3.3 nF	332				0.85 ±0.1		
3.9 nF	392						
4.7 nF	472						
5.6 nF	562				1.15 ±0.1	0.85 ±0.1	
6.8 nF	682						

MLCC - NP0 / Yageo brand

NP0, 50V, general purpose

NP0 - 50V								
General purpose								
Capacitance	Last 3 digits of Yageo part number	50V						
		0402	0603	0805	1206	1210	1812	
8.2 nF	822							
10 nF	103							
12 nF	123						0.85 ±0.1	
15 nF	153							
18 nF	183						1.15 ±0.15	
22 nF	223							
Tape width		8mm					12mm	

Note: Values in shaded cells indicate thickness class (Unit: mm)

MLCC - NP0 / Yageo brand

NP0, 100V, general purpose

NP0 - 100V						
General purpose						
Capacitance	Last 3 digits of Yageo part number	100V				
		0603	0805	1206	1210	1812
10 pF	100	0.8 ±0.07	0.6 ±0.1	0.6 ±0.1		
12 pF	120					
15 pF	150					
18 pF	180					
22 pF	220					
27 pF	270					
33 pF	330					
39 pF	390					
47 pF	470					
56 pF	560					
68 pF	680					
82 pF	820					
100 pF	101					
120 pF	121					
150 pF	151					
180 pF	181					
220 pF	221					
270 pF	271					
330 pF	331					
390 pF	391					
470 pF	471					
560 pF	561					
680 pF	681					
820 pF	821					
1000 pF	102					
1.2 nF	122		0.85 ±0.1			
1.5 nF	152					
1.8 nF	182					
2.2 nF	222		1.25 ±0.1			
2.7 nF	272					
3.3 nF	332			0.85 ±0.1		
3.9 nF	392					
4.7 nF	472					
5.6 nF	562			1.15 ±0.1		
6.8 nF	682					
8.2 nF	822				0.85 ±0.1	
10 nF	103					
12 nF	123					0.85 ±0.1
15 nF	153					
18 nF	183					1.15 ±0.15
22 nF	223					
Tape width		8mm				12mm

Note: Values in shaded cells indicate thickness class (Unit: mm)

MLCC - NP0 / Yageo brand

NP0, 200V and 500V, medium voltage

NP0 - 200V and 500V								
Medium voltage								
Capacitance	Last 3 digits of Yageo part number	200V				500V		
		0805	1206	1210	1812	1206	1210	1812
10 pF	100	0.6 ±0.1	0.6 ±0.1			0.6 ±0.1		
12 pF	120							
15 pF	150							
18 pF	180							
22 pF	220							
27 pF	270							
33 pF	330							
39 pF	390							
47 pF	470						0.85 ±0.1	
56 pF	560							
68 pF	680							
82 pF	820							
100 pF	101							
120 pF	121							
150 pF	151							
180 pF	181							
220 pF	221	0.85 ±0.1	0.85 ±0.1			0.85 ±0.1		
270 pF	271							
330 pF	331							
390 pF	391							
470 pF	471							
560 pF	561	1.25 ±0.1				1.15 ±0.1		
680 pF	681							
820 pF	821							
1000 pF	102						1.15 ±0.15	
1.2 nF	122							
1.5 nF	152		1.15 ±0.1					
1.8 nF	182			0.85 ±0.1				
2.2 nF	222							1.15 ±0.15
2.7 nF	272			1.15 ±0.15				
3.3 nF	332							
3.9 nF	392				0.85 ±0.1			
4.7 nF	472				1.15 ±0.15			
5.6 nF	562							
Tape width		8mm			12mm		12mm	

Note: Values in shaded cells indicate thickness class (Unit: mm)

MLCC - X7R / Yageo brand

X7R, 10V, general purpose

X7R - 10V				
General purpose				
Capacitance	Last 3 digits of Yageo part number	10V		
		0603	0805	1206
150 nF	154	0.8 ±0.07		
220 nF	224		0.6 ±0.1	
330 nF	334		0.85 ±0.1	
470 nF	474			
680 nF	684		1.25 ±0.1	
1000 nF	105			0.85 ±0.1
1.5 µF	155			1.15 ±0.1
2.2 µF	225			
4.7 µF	475			1.6 ±0.2
Tape width		8 mm		

Note: Values in shaded cells indicate thickness class (Unit: mm)

MLCC - X7R / Yageo brand

X7R, 16V and 25V, general purpose

X7R - 16V and 25V										
General purpose										
Capacitance	Last 3 digits of Yageo part number	16V				25V				
		0402	0603	0805	1206	0402	0603	0805	1206	1210
3.3 nF	332					0.5 ±0.05				
4.7 nF	472									
6.8 nF	682	0.5 ±0.05								
10 nF	103						0.8 ±0.07	0.6 ±0.1		
15 nF	153									
22 nF	223									
33 nF	333		0.8 ±0.07							
47 nF	473	0.5 ±0.05		0.6 ±0.1				0.85 ±0.1		
68 nF	683									
100 nF	104			0.85 ±0.1					0.85 ±0.1	
150 nF	154									
220 nF	224				0.85 ±0.1					0.85 ±0.1
330 nF	334			1.25 ±0.1					1.15 ±0.1	
470 nF	474				1.15 ±0.1					
680 nF	684									
1000 nF	105								1.6 ±0.2	
Tape width		8mm								

Note: Values in shaded cells indicate thickness class (Unit: mm)

MLCC - X7R / Yageo brand

X7R, 50V and 100V, general purpose

X7R - 50V and 100V												
General purpose												
Capacitance	Last 3 digits of Yageo part number	50V						100V				
		0402	0603	0805	1206	1210	1812	0805	1206	1210	1812	
100 pF	101	0.5 ±0.05	0.8 ±0.07									
150 pF	151											
220 pF	221			0.6 ±0.1	0.85 ±0.1			0.6 ±0.1	0.85 ±0.1			
330 pF	331											
470 pF	471											
680 pF	681											
1000 pF	102											
1.5 nF	152											
2.2 nF	222											
3.3 nF	332											
4.7 nF	472											
6.8 nF	682											
10 nF	103					0.85 ±0.1						
15 nF	153							0.85 ±0.1				
22 nF	223											
33 nF	333			0.85 ±0.1								
47 nF	473									0.85 ±0.1		
68 nF	683								1.15 ±0.1			
100 nF	104						1.15 ±0.1				1.15 ±0.1	
150 nF	154				1.15 ±0.1	1.15 ±0.1				1.15 ±0.1		
220 nF	224											
330 nF	334											
470 nF	474										1.6 ±0.2	
680 nF	684							1.6 ±0.2				
1000 nF	105											
Tape width		8mm					12mm		8mm			12mm

Note: Values in shaded cells indicate thickness class (Unit: mm)

MLCC - X7R / Yageo brand

X7R, 200V, 250V and 500V, medium voltage

X7R - 200 V and 500 V								
Medium voltage								
Capacitance	Last 3 digits of Yageo part number	200V				500V		
		0805	1206	1210	1812	1206	1210	1812
220 pF	221	0.85 ±0.1						
330 pF	331							
470 pF	471					1.15 ±0.1		
680 pF	681		0.85 ±0.1					
1000 pF	102							
1.5 nF	152							
2.2 nF	222							
3.3 nF	332						1.15 ±0.1	
4.7 nF	472							
6.8 nF	682	1.25 ±0.1						
10 nF	103							1.15 ±0.1
15 nF	153							
22 nF	223		1.15 ±0.1	1.15 ±0.1				
33 nF	333							
47 nF	473				1.15 ±0.1			
68 nF	683							
100 nF	104							
Tape width		8mm			12mm	8mm		12mm

Note: Values in shaded cells indicate thickness class (Unit: mm)

MLCC - Y5V / Yageo brand

Y5V, 10V to 50V, general purpose

Y5V - 16V to 50V											
General purpose											
Capacitance	Last 3 digits of Yageo part number	16V				25V			50V		
		0402	0603	0805	1206	0603	0805	1206	0603	0805	1206
10 nF	103	0.5 ±0.05				0.8 ±0.07			0.8 ±0.07	0.6 ±0.1	
22 nF	223										
47 nF	473										
100 nF	104						0.6 ±0.1	0.6 ±0.1			0.6 ±0.1
220 nF	224		0.8 ±0.07				0.85 ±0.1			0.85 ±0.1	
470 nF	474			0.85 ±0.1			1.25 ±0.1	0.85 ±0.1			0.85 ±0.1
1000 nF	105			1.25 ±0.1	0.85 ±0.1			1.15 ±0.1			1.15 ±0.1
Tape width		8mm									

Note: Values in shaded cells indicate thickness class (Unit: mm)

General information

Ordering and packing

Ordering Information:

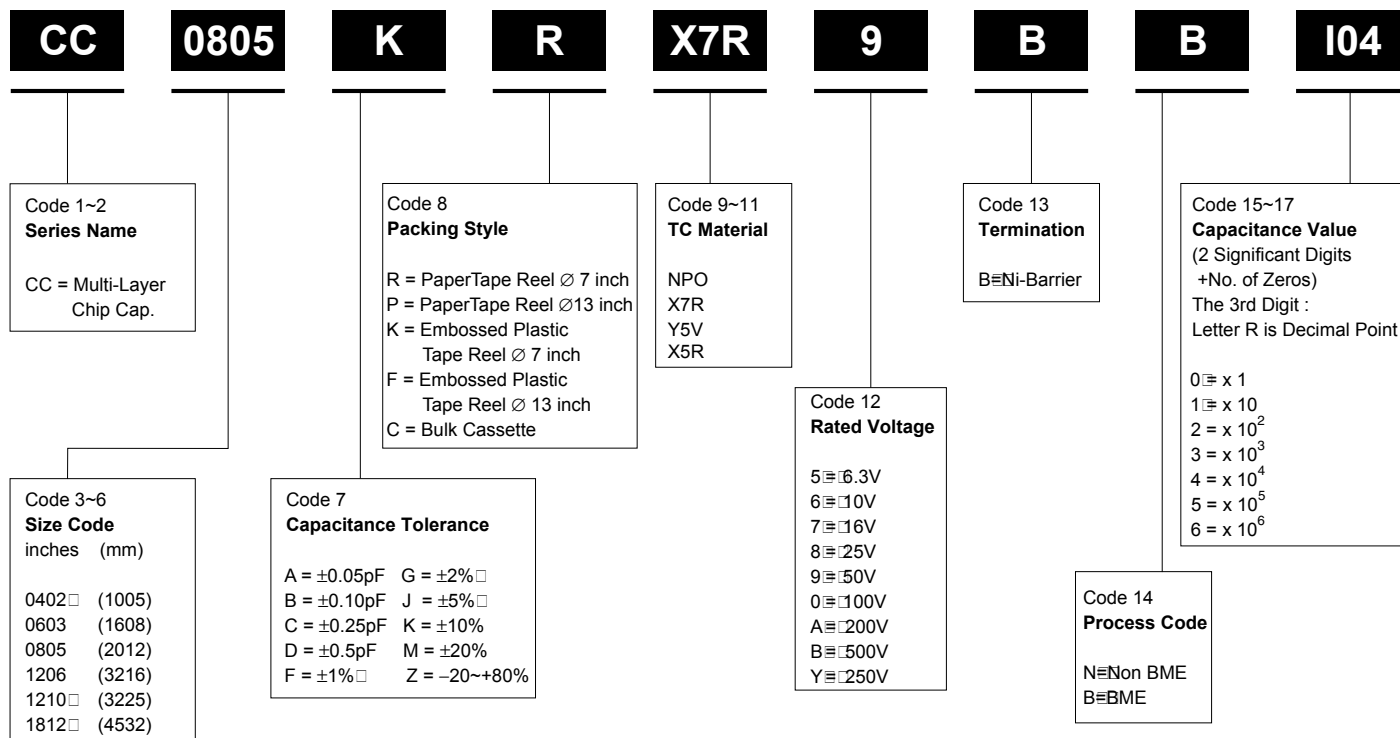

Thickness classes and packing quantities							
Size Code	Thickness Classification (mm)	Tape Width Quantity Per Reel	180 mm / 7"		330 mm / 13"		Quantity Per Bulk Case
			Paper	Blister	Paper	Blister	
CC0402	0.5±0.05	8 mm	10 000	---	50 000	---	50 000
CC0603	0.8±0.07	8 mm	4 000	---	15 000	---	15 000
CC0805	0.6±0.1	8 mm	4 000	---	20 000	---	10 000
	0.85±0.1	8 mm	4 000	---	15 000	---	8 000
	1.25±0.1	8 mm	---	3 000	---	10 000	5 000
CC1206	0.6±0.1	8 mm	4 000	---	20 000	---	---
	0.85±0.1	8 mm	4 000	---	15 000	---	---
	1.15±0.1	8 mm	---	3 000	---	10 000	---
	1.6±0.2	8 mm	---	2 000	---	10 000	---
CC1210	0.6±0.1	8 mm	---	4 000	---	15 000	---
	0.85±0.1	8 mm	---	4 000	---	10 000	---
	1.15±0.1	8 mm	---	3 000	---	10 000	---
	1.15±0.15	8 mm	---	3 000	---	10 000	---
	1.9±0.2	8 mm	---	2 000	---	---	---
CC1812	2.5±0.2	8 mm	---	1 000	---	---	---
	0.6/0.85±0.1	12 mm	---	2 000	---	---	---
	1.15±0.1	12 mm	---	1 500	---	---	---
	1.15±0.15	12 mm	---	1 500	---	---	---
	1.6±0.2	12 mm	---	1 000	---	---	---
	2.5±0.2	12 mm	---	1 000	---	---	---

INDEX

ALUMINUM ELECTROLYTIC CAPACITORS

MINIATURE ALUMINUM ELECTROLYTIC CAPACITORS

19	ST [For Super Miniature]-5mm L	1,000hrs. at 85°C
21	S7 [For Super Miniature]-7mm L	1,000hrs. at 85°C
23	S5 [For Super Miniature]-5mm L	1,000hrs. at 105°C
25	SS [For Super Miniature]-7mm L	1,000hrs. at 105°C
27	SK [For General]	2,000hrs. at 85°C
30	SE-K [For General]	1,000hrs. at 105°C
33	SH [For General]	2,000hrs. at 105°C
36	SG [For Electronic Ballast]	5,000hrs. at 105°C
39	SA [For High Temperature and Load Life]	8,000hrs. at 105°C
43	SP [High Ripple and Long Life]	10,000hrs. at 105°C
46	SB [For Low Leakage Current]	1,000hrs. at 105°C
49	SR [For Horizontal Deflection]	1,000hrs. at 85°C
51	SN [For Non Polar]	1,000hrs. at 105°C
53	SC [For Low Impedance and Low E.S.R Suitable for Output of Mother Board]	2,000~3,000hrs. at 105°C
56	SM [For very Low Impedance and very Low E.S.R Suitable for Output of Mother Board]	2,000~3,000hrs. at 105°C
59	SX [For Low Impedance & Low E.S.R]	2,000~5,000hrs. at 105°C
63	SY [For Low Impedance and Low E.S.R Suitable for Output of Mother Board]	3,000~6,000hrs. at 105°C
66	SZ [For Ultra Low ESR]	2,000hrs. at 105°C
68	SQ [High Temperature for +125°C]	1,000hrs. at 125°C
70	SV [For adapter and power supply applications Series]	2,000hrs. at 105°C
72	SF [For Photo Flash Application]	5,000hrs. at 55°C

LARGE CAN ALUMINUM ELECTROLYTIC CAPACITORS

74	LH Series	2,000 hrs. at 85°C
79	LG Series	2,000 hrs. at 105°C
84	LV Series	3,000 hrs. at 105°C

SURFACE MOUNT ALUMINUM ELECTROLYTIC CAPACITORS

88	CA Series	2,000 hrs. at 85°C
90	CB Series	1,000 hrs. at 105°C



1-1 Precautions in Using Aluminum Electrolytic Capacitors

Please note the following recommendations when use capacitors:

1. Electrolytic capacitors for DC applications require polarization .

Confirm the polarity before use . The circuit life may be shortened or the capacitor may be damaged if insert in reversed polarity . For use on circuits whose polarity is occasionally reversed , or whose polarity is unknown , use non-polar capacitors . Also note that the electrolytic capacitors cannot be used for AC applications .

2. Do not apply a voltage exceeding the capacitor's voltage rating.

If a voltage exceeding the capacitor's voltage rating is applied , the capacitor may be damaged by increased leakage current . When using the capacitor with AC voltage do not exceed the rated voltage .

3. Do not allow excessive ripple current passing.

Use the electrolytic capacitor at current value within the permissible ripple range . If the ripple exceeds the specified value , request capacitors for high ripple current applications .

4. Ascertain the operation temperature range .

Use the electrolytic capacitors according to the specified operation temperature range . Use at room temperature will ensure a longer life .

5. The electrolytic capacitor is not suitable for circuits which are charged and discharged repeatedly .

If used in circuits which are charged and discharged repeatedly , the capacitance value may drop or the capacitor may be damaged .

Please consult our engineering department for assistance in these applications .

6. When capacitors have been left unused for long time , use them only after due voltage treatments .

Long storage of capacitors tends to rise their leakage current levels . In such cases , be sure to provide the necessary voltage treatment before use .

7. Be careful of temperature and time when soldering .

When soldering a printed circuit board with various components , care must be taken that the soldering temperature is not too high and that the dipping time is not too long .

Otherwise , there will be adverse effect on the electrical characteristics and insulation sleeve of electrolytic capacitors . In the case of small -size electrolytic capacitors , nothing abnormal will be occurred if dipping is performed at less than 260°C for less than 10 seconds .

8. Cleaning circuit boards after soldering .

Halogenated hydrocarbon cleaning solvents are not recommended for use in cleaning capacitors supplied with exposed end seals .

Where cleaning with a halogenated solvent is desired , capacitors should be ordered with an Epoxy-coated end seal .

9. Do not apply excessive force to the lead wires or terminals .

If excessive force is applied to the lead wires and terminals , they may be broken or their connections on the internal elements may be affected . (For strength of terminals , please refer to JIS C5102 and C5141 .)

10. Keep the following clearance between the vent of the capacitor

and the case of the appliance . Do not block the operation of the vent , unless otherwise described on the catalogues or product specifications . The narrower clearance may adversely affect the vent operation and result in an explosion of the capacitor .

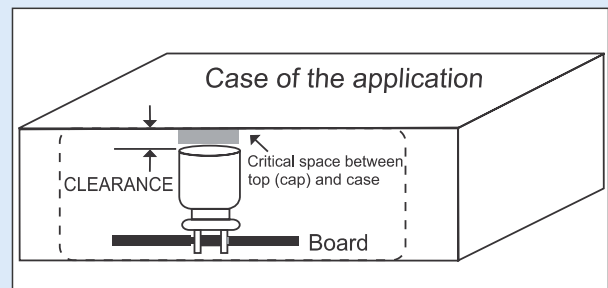

Case diameter	Clearance
ø 6.3 to ø 16 mm	2 mm minimum
ø 18 to ø 35 mm	3 mm minimum
ø 40 mm & up	5 mm minimum

Fig.1-1

Attention

- The description in this catalogue is subject to change without prior notice for product improvement . Therefore , please confirm the specification before ordering products .
- The general characteristics , reliability data , etc . , described in this catalogue should not be construed as guaranteed values , they are merely standard values .
- Before using the products , please read the notes in this catalogue carefully for proper use .

1-2 Technical Concepts

1. The material and structure of Electrolytic Capacitors

Electrolytic Capacitor is a simple module . It simply contains an insulator between relative conductors in an electrode. The major internal raw material contains an element constructed by an separator paper wrap around the anode foil and cathode foil , which is then impregnated with the electrolyte , inserted into an aluminum case and sealed.

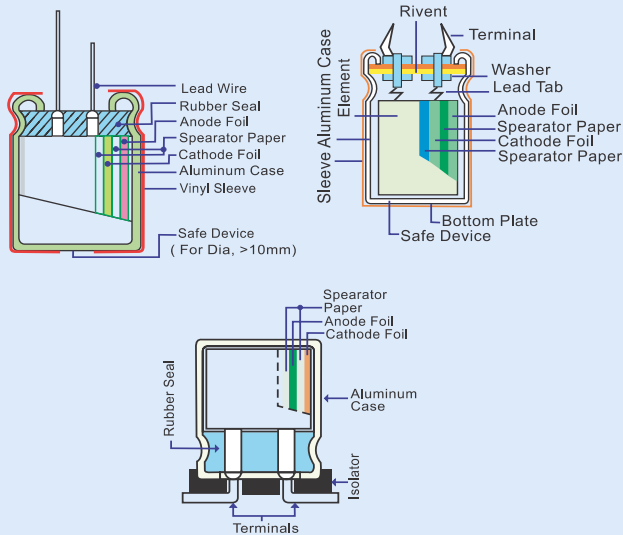

Fig.1-2

2. Production Processes

- Etching :** The process to increase surface area of aluminum foil by using chemical erosion or chemical corrosion method is called Etching . Normally chemical corrosion method uses the ripple current of electrolyte , combination of the liquid and temperature to determine the size, shape , and quantity of the dense network of microscopic channels on the aluminum foil surface .
- Forming :** The production process of the anode aluminum foil of electrolytic capacitors is by anodic oxidation of the etched aluminum foil . The production of the cathode aluminum foil sometimes involves oxidation in special purposes . This anodic oxidation process is called Forming . Boric acid or organic acid is used for high voltage forming and phosphoric acid or ammonium adipate is used for low voltage forming in order to obtain stable natural oxide layer of Al_2O_3 .
- Slitting :** The cutting of the aluminum foil and separator paper according to the required length .
- Winding :** The stitching or cold welding of cut anode and cathode foils and tab terminal , and wrap the electrolytic paper in between the anode and cathode , then fix the end with glue or sticky tape , and attached leads is called the capacitor "element" .
- Impregnation :** The process of eliminating the water from the elements by pressurizes or vacuum in order to soak the element with the electrolyte is called Impregnation . The elements fully filled with electrolyte is then centrifuged to remove excess electrolyte .
- Assembly :** The elements seal with rubber to stop the leakage of electrolyte then slip into a sleeve to form the final product .
- Aging :** The purpose of Aging is to repair the oxide film damage by recharging and electrolyte .

1-3 The Function of Electrolytic Capacitors

The electrolytic capacitors could be widely used in appliance (ie. TV , radio , audio equipment , watching machine and air conditioner.....etc .) , computer equipment (mother board, image device & the peripherals such as the printer , drawing device, scanner etc) , communication equipment , estate equipment , measure instrument and also the industrial instrument , air plane , firebomb , satellite... etc. as a piloting equipment.

*According to the inflict electric wave & using purpose , it basically with some classified purposes as below :

1. DC Voltage :

- For Momentary High Voltage :** For using to the impulse generator such as the shock wave resistance test of the heavy electric machine .
- For High Electric Current :** For using to the welding machine , X- Ray facility , copy machine and discharge processing device .
- For DC High Voltage :** The electrolytic capacitor and rectifier composing , a special DC high voltage been happened after charged , for using to the power of electronic microscope and accelerator .
- For Integration & Memory :** For either memory circuit or compare circuit inside the calculator .

2. The DC voltage that with alternate ingredient :

- For Wave Filter :** Combination with the chip resistor & inductor as a internet , to be past by DC current or some frequency to closure or decline some other frequency .
- For Bypass :** A parallel track that outside from the circuit element , the IC (integrated circuit) has been rapidly developing in this years and thus a miniaturization or chip of electrolytic capacitors for by pass was conducted .
- For Coupling :** Combination of the electrolytic capacitor , chip resistor and inductor and thus coupling together .
- For Arising of Toothed Wave :** Composing of RC charge/discharge circuit through the electrolytic capacitor as well as the resistor and a toothed wave to be created by the RC charge/discharge circuit .
- For Reverse (Change) of Circuit :** The equipment for change the AC voltage to DC voltage .

3. For AC voltage :

- For Power Improving :** Connect the end loading of layout transporting & electrolytic capacitor for power improving .
- For Wave Filter :** Prevention of external interference in SCR circuit , use the LC wave filter circuit to inhibit or erase the interference .
- For Phase Across :** Phase change of the inductive electromotor(motor) with single phase .



1-4 Basic Electrical Characteristics

1. Capacitance (E.S.C.)

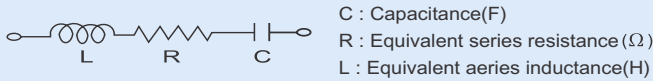

Fig.1-3 Simplified equivalent circuit diagram of an electrolytic capacitor

The capacitive component of the equivalent series circuit (equivalent series capacitance ESC) is determined by applying an alternate voltage of 0.5V at a frequency of 120 Hz .

Temperature dependence of the capacitance

The capacitance of an electrolytic capacitor depends on the temperature : with decreasing temperature , the viscosity of the electrolyte increases reducing its conductivity . The capacitance will decrease if the temperature decreases . Furthermore temperature drifts cause armature dilatation and the refore capacitance changes (up to 20% , depending on the series considered, from 0 to 80°C) . This phenomenon is more evident for electrolytic capacitors than for other types .

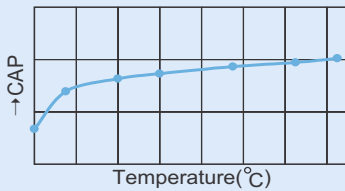

Fig 1-4 Capacitance change vs. temperature

Frequency dependence of the capacitance

The effective capacitance value is derived from the impedance curve , as long as the impedance is still in the range where the capacitance component is dominant .

$$C = \frac{1}{2\pi f Z}$$

C = Capacitance(F)
 f = Frequency(Hz)
 Z = Impedance(Ω)

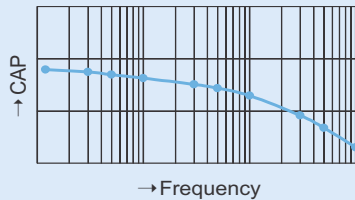

Fig 1-5 Capacitance change vs. frequency

2. Dissipation factor (tanδ)

The dissipation factor is the ratio between the active and the reactive power for a sinusoidal waveform voltage . It can be thought as a measurement of the gap between an actual and an ideal capacitor .

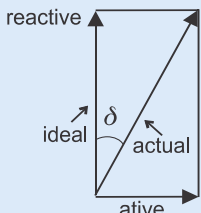

Fig 1-6

$$D.F. = \tan\delta \times 100 (\%) = \omega CR \times 100 (\%) = 2\pi fCR \times 100 (\%)$$

where: R = Equivalent Series Resistance
 C = Equivalent Series Capacitance
 $\omega = 2\pi f$

The tan δ is measured with the same set up as for the series capacitance ESC .

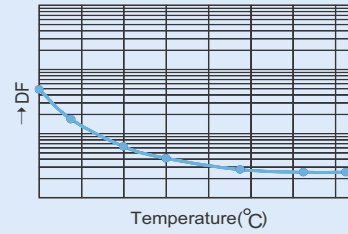

Fig 1-7 Dissipation factor vs. temperature

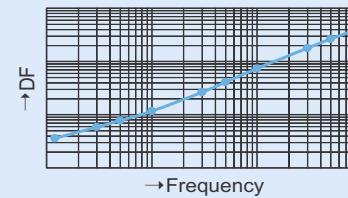

Fig 1-8 Dissipation factor vs. frequency

3. Equivalent series resistance (E.S.R.)

The equivalent series resistance is the resistive component of the equivalent series circuit . The ESR value depends on frequency and temperature and is related to the tan δ by the following equation :

$$ESR = \frac{\tan\delta}{2\pi f ESC}$$

ESR = Equivalent Series Resistance (Ω)
 tan δ = Dissipation Factor
 ESC = Equivalent Series Capacitance (F)
 f = Frequency (Hz)

The tolerance limits of the rated capacitance must be taken into account when calculating this value .

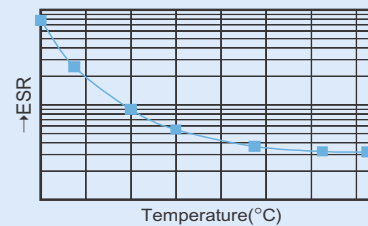

Fig 1-9 ESR change vs. temperature

The resistance of the electrolyte decreases strongly with increasing temperature.

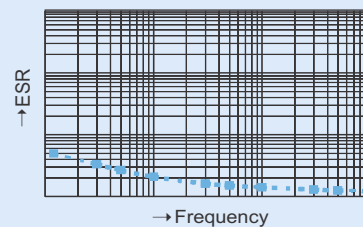

Fig 1-10 ESR change vs. frequency

4. Impedance (Z)

The impedance of an electrolytic capacitor results from here below circuit formed by the following individual equivalent series components :

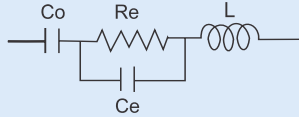

Fig 1-11

Co = Aluminum oxide capacitance (surface and thickness of the dielectric).

Re = Resistance of electrolyte and paper mixture (other resistances not depending on the frequency are not considered : tabs , plates , and so on).

Ce = Electrolyte soaked paper capacitance.

L = Inductive reactance of the capacitor winding and terminals.

The impedance of an electrolytic capacitor is not a constant quantity that retains its value under all the conditions : it changes depending on the frequency and the temperature .

The impedance as a function of frequency (sinusoidal waveform) for a certain temperature can be represented as follows :

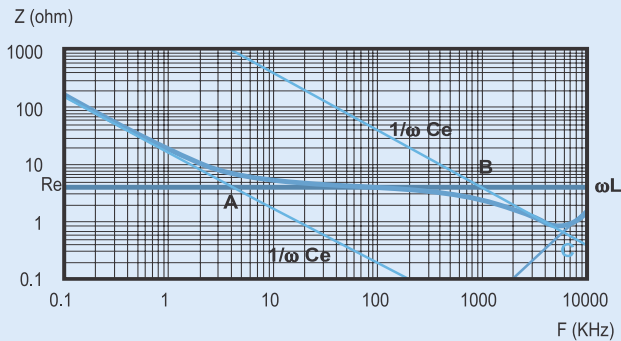

Fig 1-12

- Capacitive reactance predominates at low frequencies
 - With increasing frequency , the Capacitive reactance $X_c = 1/\omega C$ decreases until it reaches the order of magnitude of the electrolyte resistance Re (A)
 - At even higher frequencies , the resistance of the electrolyte predominates : $Z = Re$ (A - B)
 - When the capacitor's resonance frequency is reached ($\omega 0$) , capacitive and cancel each other $1/\omega C$ inductive reactance mutually cancel each other $1/\omega C = \omega L$, $\omega 0 = \text{SQR}(1/LC) = C$.
 - Above this frequency , the inductive reactance of the winding and its terminals ($X_L = Z = \omega L$) becomes effective and leads to an increase in impedance .
- Generally speaking it can be estimated that $C_e \approx 0.01 C_o$.

The impedance as a function of frequency (sinusoidal waveform) for different temperature values can be represented as follows (typical values) :

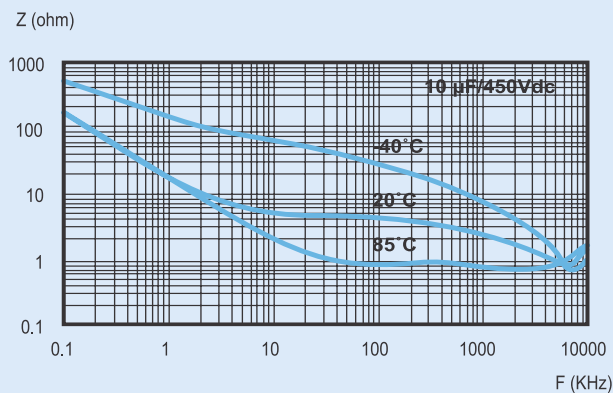

Fig 1-13

Re is the most temperature dependant component of electrolytic capacitor equivalent circuit . The electrolyte resistivity will decrease if the temperature rises . In order to obtain a low impedance value all over the temperature range , Re must be as little as possible , but too low Re values means a very aggressive electrolyte and then a shorter life of the electrolytic capacitor at the high temperatures . A compromise must be reached .

5. Leakage current (L.C.)

Due to the aluminum oxide layer that serves as a dielectric , a small current will continue to flow even after a DC voltage has been applied for long periods . This current is called leakage current . A high leakage current flows after applying a voltage to the capacitor and then decreases in few minutes (e.g. after a prolonged storage without any applied voltage) . In the course of the continuous operation , the leakage current will decrease and reach an almost constant value .

After a voltage free storage the oxide layer may deteriorate , especially at high temperature . Since there are no leakage current to transport oxygen ions to the anode , the oxide layer is not regenerated . The result is that a higher than normal leakage current will flow when a voltage is applied after prolonged storage . As the oxide layer is regenerated in use , the leakage current will gradually decrease to its normal level .

The relationship between the leakage current and the voltage applied at constant temperature can be shown schematically as follows :

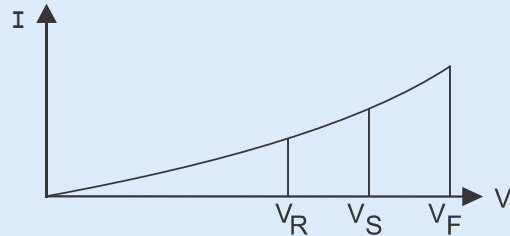

Fig 1-14

Where :

V_F = Forming voltage

If this level is exceeded a large quantity of heat and gas will be generated and the capacitor could be damaged .

V_R = Rated Voltage

This level represents the top of the linear part of the curve .

V_S = Surge voltage

It lies between V_R and V_F : the capacitor can be subjected to V_S for short periods only .



1-5 Reliability

(1) The bathtub curve:

Aluminum electrolytic capacitors feature failure rates shown by the following bathtub curve.

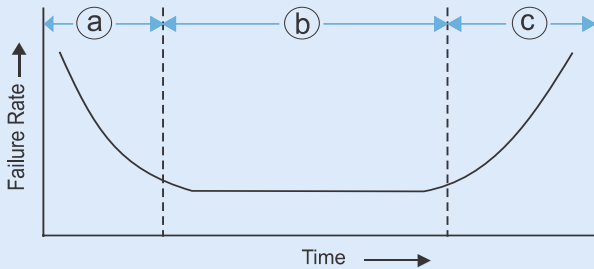

Fig.1-15 Bathtub curve

a. Initial failure period

Deficient Capacitors include any products before dispatch that may have some deficiency caused by the design, production process or used in inappropriate environments.

b. Random failure period

The capacitors have a low defect ratio in the period after it has been stabilized.

c. Wear out failure period

The performance of capacitors will decrease with an increase in usage period. The malfunction rate may vary due to the structural design.

(2) Failure types: (See Table-1)

a). Completely malfunction:

Capacitor is completely disabled to all functions, e.g.: short circuit, open circuit.

b). Malfunction cause by wear and tear gradual malfunctioning of the capacitor, the cause of the malfunction would depend on the environmental conditions.

pressure & vibration... etc. and mostly affected by temperature factor .

Electrical condition include voltage , ripple current and charge / discharge condition... etc.

1. Temperature & Life

The reduce capacitance & increase DF will be created by the influence from temperature on the life, such condition mostly caused by a slow evaporation from the electrolyte to seal position; the electric specificity that is affected by timing and surrounding temperature as following formula below and similar to the chemical kinetics of Arrhenius' rule and to be reputed as the connection rule of life in electrolytic capacitors.

$$L_x = L_0 \times B^{\frac{T_0 - T_x}{10}} \quad \text{Eq.1}$$

L_x : Expected Life at Operating Temperature T_x °C (hour)

L_0 : Load Life at Maximum Operating Temperature T_0 °C (hour)

T_0 : Maximum Operating Temperature (°C)

T_x : Actual Operating Temperature. (°C)

B : Accelerate Coefficient of Temperature (≈ 2)

From the Eq.1 , it means about double acceleration for temperature raising at 10 C . Therefore , it comes a longer working life once a temperature setting lower than T_x while products design .

2. Rated Voltage and Life

While working , the voltage under the input of rated voltage and for the reducing of volt age, although with little or more influence to electrolytic capacitors but, no necessary for special concern after compare with the influence by temperature.

1-6 Life of the Electrolytic Capacitors

A effects by using condition for the life of electrolytic capacitors which environmental condition & electrical condition .

Environmental condition include temperature , humidity , atmospheric

Table-1 Failure modes and causes

Failure Modes	Internal Causes	Primary Factors		
		Mismanaged Production	Mishandled Application	Unavoidable Factors in Normal Service
Short Circuit	Short Circuit Between Electrodes	Burred Foil/ Metal Particle	Mechanical Stress	Deterioration With Time
	Dielectrical Break of Oxide Layer	Local Deficiency in Oxide Layer		
Open Circuit	Dielectrical Break of Separator	Mechanical Stress	Poor Connection	
	Disconnection of Terminal Construction			
Capacitance Drop	Poor Terminal Connection	Electrochemical Reaction	Excessive Thermal Stress	
	Less Electrolyte			
tanδ (ESR) Increase	Electrolyte Vaporization	Excessive Operating Voltage	Reverse Voltage	
	Anode Foil Capacitance Drop			
Leakage Current Increase	Cathode Foil Capacitance Drop	Excessive Ripple Current	Excessive Charge-Discharge Duty	
	Deterioration of Oxide Layer			
Open Vent	Corrosion	Contamination By Chloride	Chloride Contamination By Assembly Board Cleaning	
	Internal Pressure Rise			
Electrolyte Leakage	Poor Sealing	Poor Sealing		



1-7 Cleaning Agings

3. Influence of Input Ripple Current Against Working life

Passing of some ripple current when the electrolytic capacitor has a wave filter or smoothing function, the internal temperature of electrolytic capacitor will be brought some more influence to working life as well. Hence, a maximum ripple current will be listed caused by such ripple current and directly specifically by each manufacturer; it has been considered as overlapping by DC voltage & AC voltage when incorporate electrolytic capacitors with a power that ripple current included. The losing electronic power caused by the alternate resistance & direct leakage current inside the electrolytic capacitors will be come to heat. Kindly refer to following for relation between in rated ripple current and temperature raising:

$$W = (I_{\text{Ripple}})^2 \cdot R_{\text{ESR}} + V \cdot I_{\text{Leakage}} \quad \text{Eq.3}$$

where W: Internal power loss

I Ripple : Ripple current

R ESR: Equivalent Series Resistance

V : Applied voltage

I Leakage : Leakage current

Normally the losing voltage power of DC leakage current that caused by the DC voltage which to be inflicted in the electrolytic capacitor will be lower than a losing voltage power caused by ripple current, therefore:

$$W \approx (I_{\text{RIPPLE}})^2 \cdot R_{\text{ESR}} \quad \text{Eq.4}$$

The formula for reaching of temperature balance on the internal temperature raising as well as the hot dissipation as below:

$$W \approx (I_{\text{RIPPLE}})^2 \cdot R_{\text{ESR}} = \beta \cdot A \cdot \Delta T \quad \text{Eq.5}$$

β : Heat radiation constant

A= Surface area of container (cm²)

A= $\pi/4 \cdot D \cdot (D + 4L)$

D: case diameter (cm)

L: case length (cm)

ΔT : Temperature raising created by internal heating (°C).

Through the formula above can see the temperature raising caused by the ripple current and:

$$\Delta T = \frac{(I_{\text{RIPPLE}})^2 \cdot R_{\text{ESR}}}{\beta A} = \frac{(I_{\text{RIPPLE}})^2 \cdot \tan \delta}{\beta A \omega C} \quad \text{Eq.6}$$

$$\text{Due to : } R_{\text{ESR}} = \frac{\tan \delta}{\omega C}$$

Tan δ : DF at 120HZ

ω : $2\pi f$ (f = 120HZ)

C : The static capacity (F) at 120HZ

In general, the allowed ripple current value would be specifically listed by the manufacturer - A revised coefficient of allowed ripple current & working frequency to the electrolytic capacitor.

Table-2 Snap-in terminal type capacitors (for input smoothing circuit)

Frequency (Hz)	50	60	120	1K	10K~100K	
Frequency	6.3~100V	0.88	0.90	1.00	1.15	1.16
Coefficient	160~250V	0.85	0.88	1.00	1.15	1.20
Kf	315~450V	0.88	0.90	1.00	1.10	1.15

Table-3 Lead type capacitors (for output smoothing circuit)

Frequency (Hz)	50	120	300	1K	10K	100K
~47 μ F	0.30	0.40	0.50	0.70	0.80	1.00
5.6~33 μ F	0.40	0.50	0.60	0.80	0.90	1.00
34~330 μ F	0.60	0.70	0.80	0.90	0.95	1.00
331~1000 μ F	0.65	0.90	0.90	0.98	1.00	1.00
1200 μ F~Higher	0.85	0.90	0.95	0.98	1.00	1.00

Table-4 The coefficient between allowed ripple current & working temperature to the electrolytic capacitors.

Surrounding Temp[°C]	Revised coefficient of Temperature				
	60	65	70	85	105
Snap-in terminal type	2.37		2.17	1.67	1.00
Lead type capacitors		1.80		1.50	1.00

Circuit Board Cleaning

1. Foreword

When a halide substance seeps into the aluminum electrolytic capacitor The halide dissolves and frees halogen ions.



Also the following reaction can occur

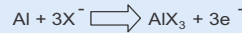

When this reaction is repeated. The leakage current increases and the safety vent will be activated and may lead to open vent. Because of this halogen type cleaning agents or adhesive material and coating material is not recommended for usage. The following explains the recommended condition for cleaning. When a halogen type cleaning agent will be used due to cleaning capabilities.

2. Recommended Cleaning Condition

Applicable : Any type.any ratings

Cleaning Agents : Pine Alpha ST-100S

Clean Through 750H,750L,710M

Sanelek B-12

Aquq Cleaner 210 SEP

Techno Care FRw 14~17

Isopropyl Alcohol

Cleaning Conditions : Total cleaning time shall be no greater than 5 minutes by immersion, ultrasonic or other method.

After cleaning, capacitors should be dried using hot air for minimum of 10 minutes along with the PC board.

Hot air temperature should be below the maximum operating temperature of the capacitor.

Insufficient dries after water runse may cause appearance problems, such as sleeve shrinking, bottom-plate bulging.

It is recommended to monitor conductivity, pH, and concentration of the agent. Please do not keep a product after cleaning in condition that cleaning agents exists as steam, or in non ventilated containers.

3. CFC substitute

The anti-solvent capacitor listed in the catalogue can be cleaned using AK-255AES. If used within the following condition.

Please monitor contamination of solution by measuring conductivity, pH, specific gravity, water content and such.

Furthermore, do not store capacitors in a cleaning agent atmosphere or sealed container after cleaning.

Also avoid using using ozone depleting substances for cleaning agents in difference to our global environments.

Applicable : Anti-solvent capacitors

Cleaning Agents : AK-255AES

Cleaning Conditions : Within 5 minutes, total cleaning time by immersion, vapor spray, or ultrasonic and such. For SMD and ultra-miniature type 2 minutes maximum of total cleaning time.

4. Fixing Material and Coating Material

- DO not use any affixing or coating materials, which contain halide substance.
- Remove flux and any contamination, which remains in the gap between the end seal and PC board.
- Remove flux and any contamination, which remains in the gap between the end seal and PC board.
- Please dry the cleaning agent on the PC board before using affixing or coating material.
- Please do not apply any material all around the end seal when using affixing or coating material.

There are variations of cleaning agents, fixing and coating material, so please contact those manufacture or our sales office to make sure that the material would not cause any problems.



RADIAL TYPE ORDERING CODE

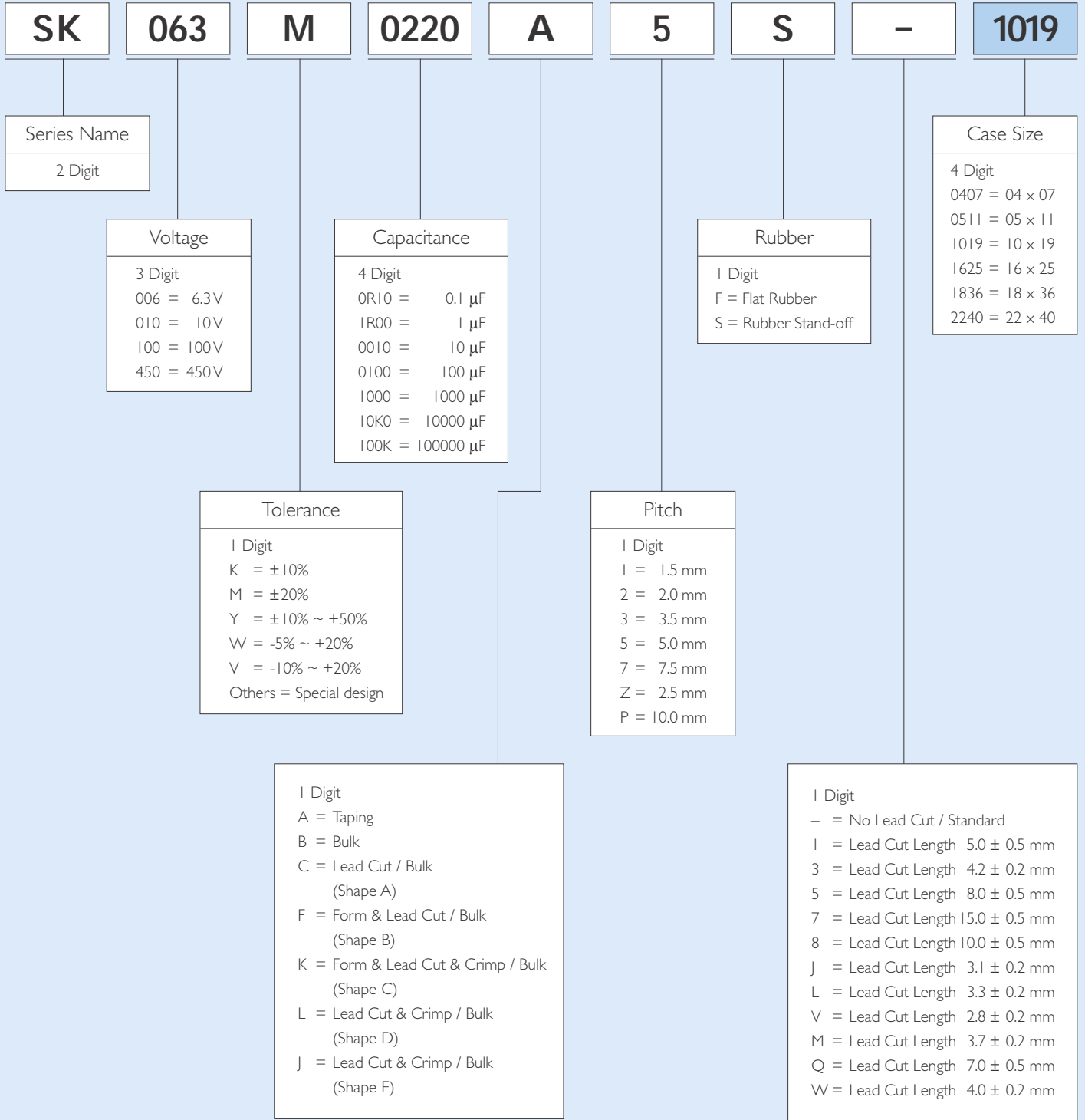



SNAP IN TYPE ORDERING CODE

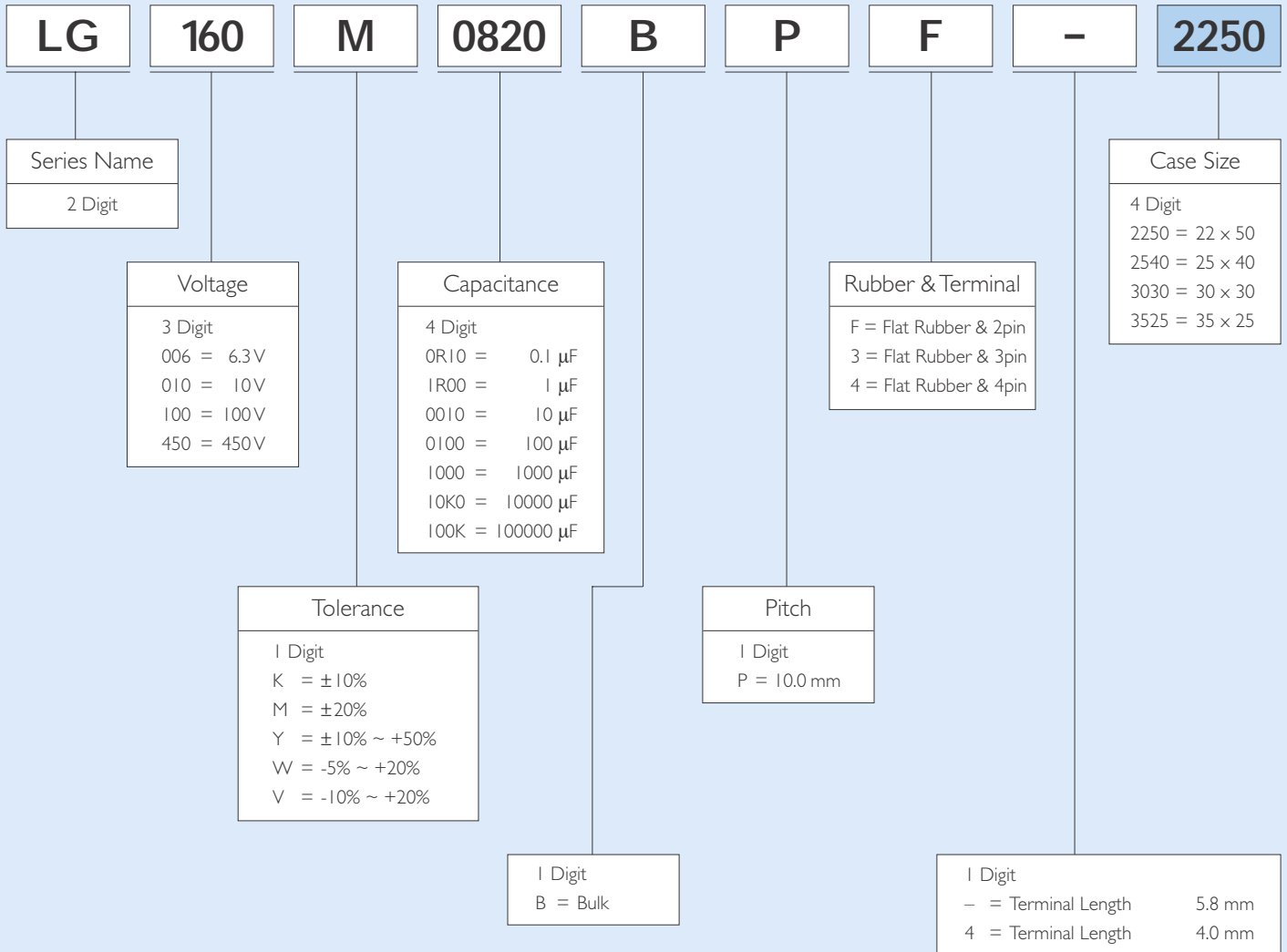



SMD TYPE ORDERING CODE

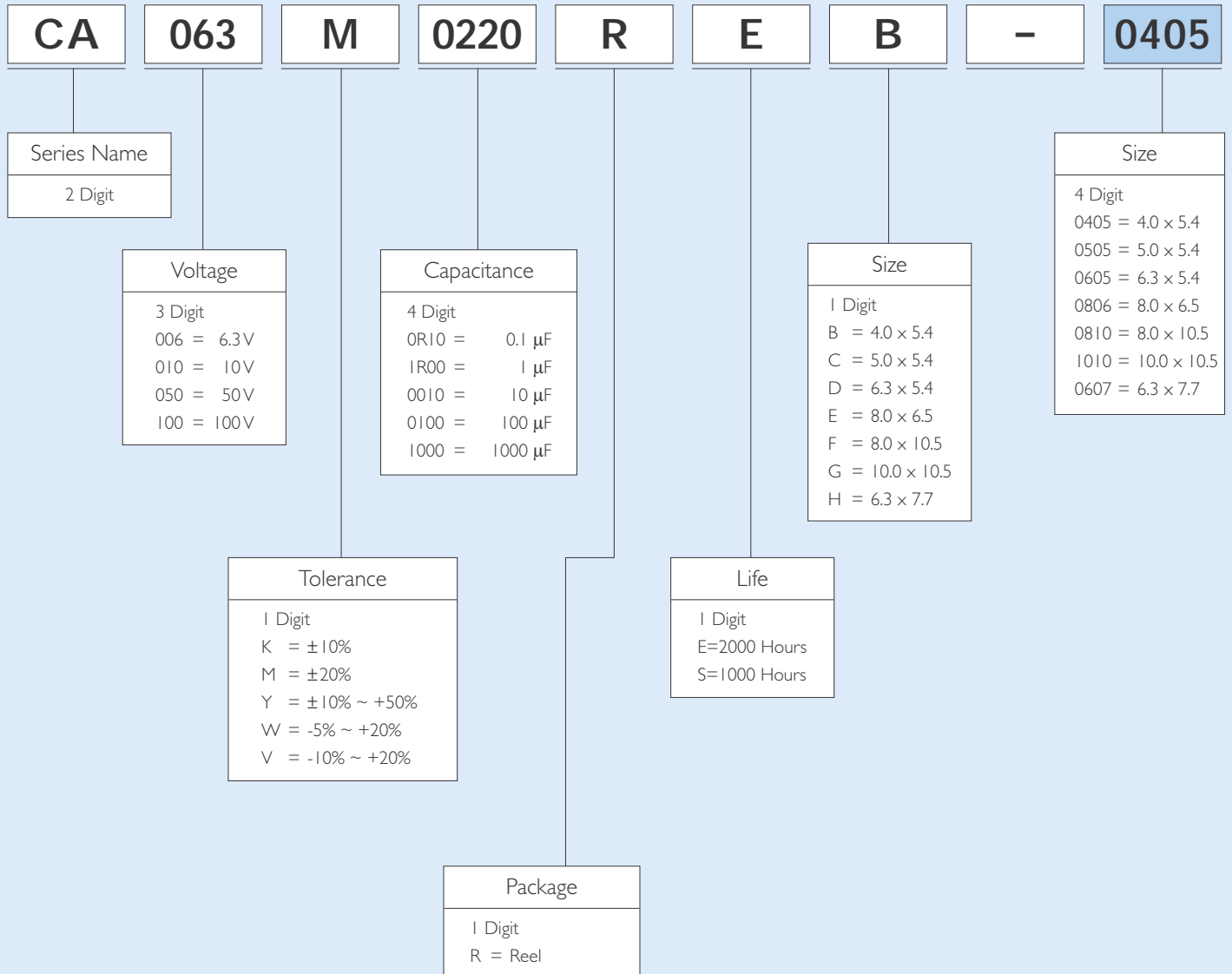



DIAGRAM OF TAPING DIMENSIONS

Unit : mm

Fig. 1

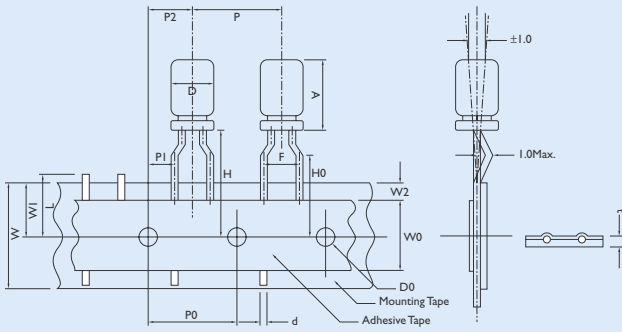

Fig. 4

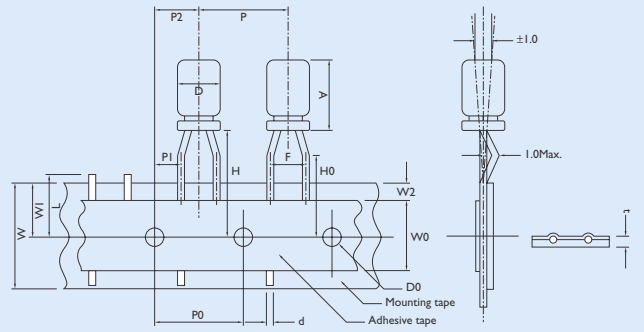

Fig. 2

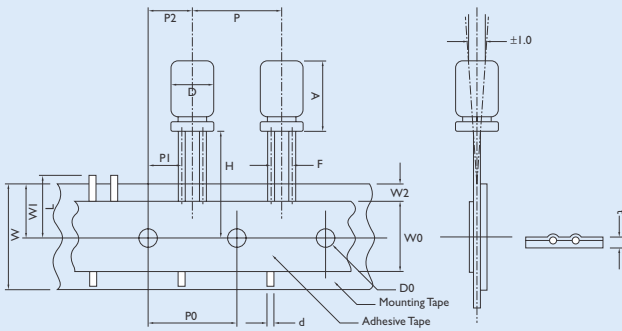

Fig. 5

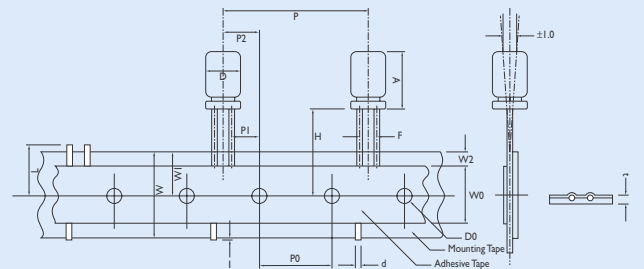

Fig. 3

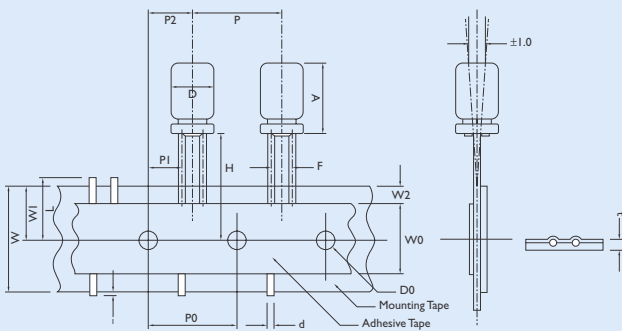
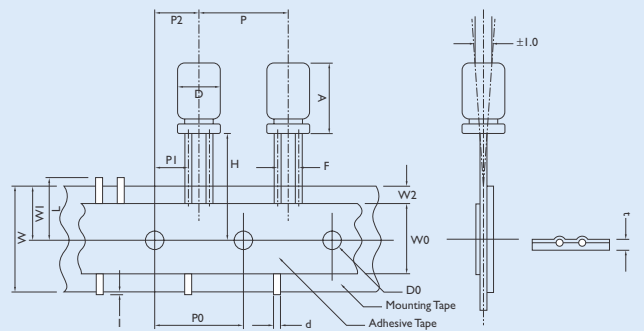

Fig. 6





SPECIFICATIONS INFORMATION

Unit : mm

ITEM	TOLERANCE	PH = 2.5		FORMED LEAD TYPE						STRAIGHT LEAD TYPE									
		L		L						L									
		5~7	≤7 >7	5~7	≤7 >7	≤7 >7	≤7 >7	≤7 >7	5~7	≤7 >7	≤7 >7	≤7 >7	≤7 >7	≤7 >7	12-25	15-25	15-25		
D	+0.5 -0	4ø	5ø	4ø	5ø	6ø	8ø		4ø	5ø	6ø	8ø		10ø	12ø	12.5ø	13ø	16ø	18ø
A	Max.	8.0	13	8.0	13	8.0	13	8.0	22.0	8.0	13	8.0	13	8.0	22.0	27.0			
d	±0.05	0.45	0.5	0.45	0.5	0.5	0.5	0.5	0.5	0.45	0.5	0.5	0.5	0.5	0.5	0.6			0.8
P	±1.0	12.7		12.7						12.7							15.0		30.0
P0	±0.3	12.7		12.7						12.7							15.0		
P1	±0.7	5.1		3.85						5.6	5.35	5.1	4.6	3.85					3.75
P2	±1.3	6.35		6.35						6.35						7.5			
F	+0.8, -0.2	2.5		5.0						1.5	2.0	2.5	3.5	5.0					7.5 ± 0.8
W	+1.0, -0.5	18.0		18.0						18.0									
W0	±0.5	12.0		12.0						12.0									
W1	±0.5	9.0		9.0						9.0									
W2	Max.	3.0		3.0						3.0									
H	±0.75	18.5		18.5						18.5									
H0	±0.5	16.0		16.0															
I	Max.	-		-										1.0					
D0	±0.2	4.0		4.0						4.0									
t	±0.2	0.7		0.7						0.7									
L	Max.	11.0		11.0						11.0									
Fig.		4		1						2						3, 6			5



DIAGRAM OF LEAD CUTTING AND FORMING

Unit : mm

Shape (A)

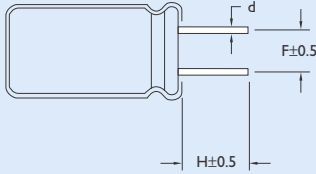

Shape (C)

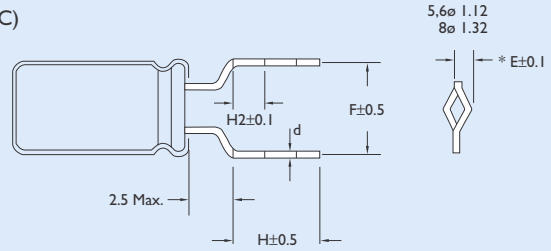

Shape (B)

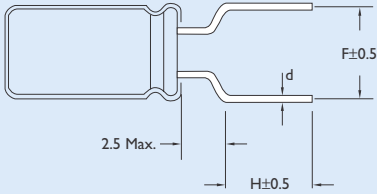

Shape (D)

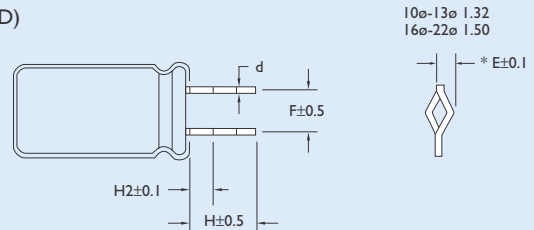

Shape (E)

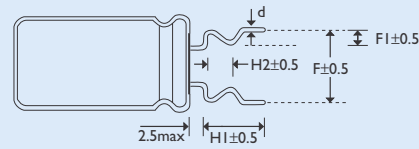

SPECIFICATIONS INFORMATION

Unit : mm

NO.CUTTING &

FORMING METHODS		Dø	4ø	5ø	6ø	8ø	10ø	12ø	13ø	16ø	18ø	22ø			
A	Lead Cut Only	F	1.5	2.0	2.5	3.5	5.0	5.0	5.0	7.5	7.5	10			
		H	5.0	5.0	5.0	5.0	5.0	5.0	5.0	5.0	5.0	5.0			
		d	0.45	0.5	0.5	0.5	0.6	0.6	0.6	0.8	0.8	0.8			
B	Lead Cut and Form	F	5.0	5.0	5.0	5.0									
		H	5.0	5.0	5.0	5.0									
		d	0.45	0.5	0.5	0.5									
C	Lead Cut, Crimp and Form	F	5.0	5.0	5.0	5.0	5.0	5.0	5.0	5.0	5.0	5.0			
		H1	5.0	4.2	5.0	4.2	4.0	5.0	4.2	4.0	5.0	4.2	4.0		
		H2	2.5	2.0	2.5	2.0	2.0	2.5	2.0	2.0	2.5	2.0	2.0		
		d	0.45	0.5	0.5	0.5	0.5	0.5	0.5	0.5	0.5	0.5	0.5		
D	Lead Cut and Crimp	F					5.0	5.0	5.0	7.5	7.5	7.5	10		
		H1					5.0	4.2	4.0	5.0	4.2	4.0	5.0	4.2	4.0
		H2					2.5	2.0	2.0	2.5	2.0	2.0	2.5	2.0	2.0
		d					0.6	0.6	0.6	0.8	0.8	0.8			
E	Lead Cut Form and Crimp	F	5.0	5.0	5.0	5.0									
		F1	1.2	1.2	1.2	1.2									
		H1	4.0	4.0	4.0	4.0									
		H2	1.8	1.8	1.8	1.8									
		d	0.45	0.5	0.5	0.5									



PACKAGE INFORMATION

TYPE	D x L	BULK			TAPING		LEAD CUTTING		
		I BAG/PCS	I INNER BOX	I CARTON	I INNER BOX	I CARTON	I BAG/PCS	I INNER BOX	I CARTON
RADIL	(mm)								
	04 x 05	1000	10,000	20,000	2,500	25,000	1000	15,000	30,000
	05 x 05	1000	10,000	20,000	2,000	20,000	1000	15,000	30,000
	06 x 05	1000	10,000	20,000	2,000	20,000	1000	15,000	30,000
	04 x 07	1000	10,000	20,000	2,500	25,000	1000	15,000	30,000
	05 x 07	1000	10,000	20,000	2,000	20,000	1000	15,000	30,000
	06 x 07	1000	10,000	20,000	2,000	20,000	1000	15,000	30,000
	05 x 11	500	10,000	20,000	2,000	20,000	500	15,000	30,000
	06 x 11	500	10,000	20,000	2,000	20,000	500	15,000	30,000
	08 x 11	500	6,000	12,000	1,000	10,000	500	8,000	16,000
	08 x 15	500	5,000	10,000	1,000	10,000	500	5,000	10,000
	08 x 20	200	4,000	8,000	1,000	10,000	200	4,000	8,000
	10 x 12	200	4,000	8,000	700	7,000	200	4,000	8,000
	10 x 15	200	3,000	6,000	700	7,000	200	4,000	8,000
	10 x 16	200	3,000	6,000	700	7,000	200	4,000	8,000
	10 x 19	200	2,400	4,800	700	7,000	200	3,000	6,000
	10 x 25	200	2,400	4,800	700	7,000	200	2,400	4,800
	10 x 27	200	2,000	4,000			200	2,000	4,000
	10 x 30	200	2,000	4,000			200	2,000	4,000
	12 x 20	200	2,000	4,000	500	5,000	200	2,000	4,000
	12 x 25	200	1,800	3,600	500	5,000	200	1,800	3,600
	12 x 30	200	1,600	3,200	500	5,000	200	1,600	3,200
	12 x 35	200	1,000	2,000	500	5,000		500	3,000
	12 x 40	200	1,000	2,000	500	5,000		500	3,000
	13 x 20	200	1,800	3,600	500	5,000	200	1,800	3,600
	13 x 25	200	1,400	2,800	500	5,000	200	1,400	2,800
	13 x 30	200	1,200	2,400	500	5,000		500	3,000
	13 x 40	200	1,000	2,000	500	5,000		500	3,000
	16 x 25	200	1,000	2,000	300	3,000		500	4,000
	16 x 32	200	800	1,600				500	3,000
	16 x 36	200	600	1,200				500	3,000
	16 x 40	200	600	1,200				500	3,000
	18 x 20	200	800	1,600			200	1,000	2,000
	18 x 25	200	800	1,600				500	2,000
	18 x 32	100	500	1,000				500	2,000
	18 x 36	100	500	1,000				500	2,000
	18 x 40	100	500	1,000				500	2,000
	22 x 40	100	300	600				400	800

TYPE	D x L	BULK		
		I BAG/PCS	I INNER BOX	I CARTON
SNAP-IN	(mm)			
	22 x 25 ~ 45		400	800
	25 x 25 ~ 50		200	400
	30 x 25 ~ 35		200	400
	30 x 40 ~ 50		200	400
	35 x 30 ~ 50		200	400



1. Carrier Tape Dimension

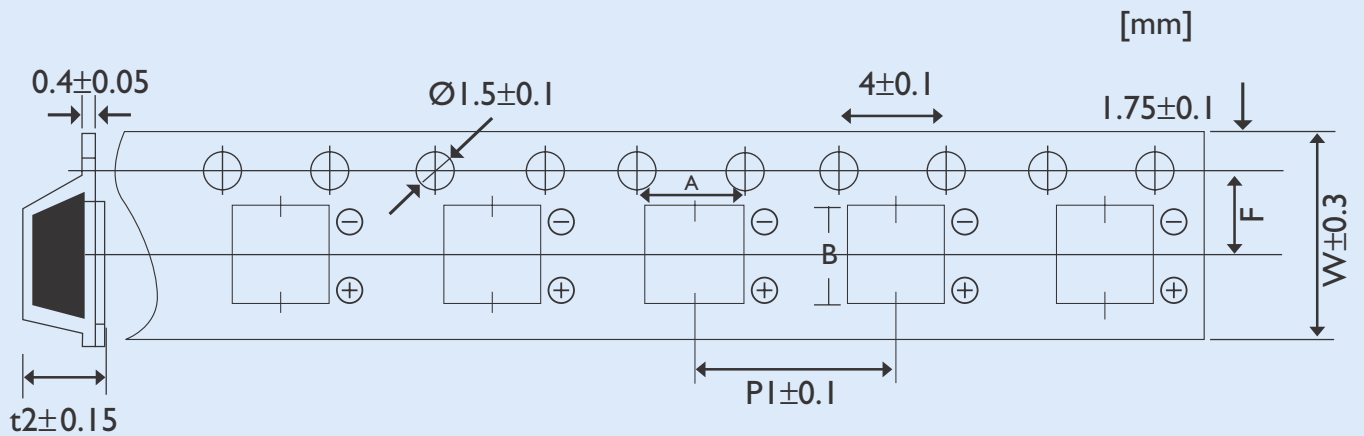

CASE SIZE	(ØD mm)	W	A	B	P1	F	t2
B	Ø4	12.0	4.7	4.7	8.0	5.5	5.75
C	Ø5	12.0	5.7	5.7	12.0	5.5	5.8
D	Ø6.3 × 5.4	16.0	7.0	7.0	12.0	7.5	5.75
E	Ø8 × 6.2	16.0	8.7	8.7	12.0	7.5	6.8
F	Ø8 × 10.2	24.0	8.7	8.7	16.0	11.5	11.0
G	Ø10 × 10.2	24.0	10.7	10.7	16.0	11.5	11.0
H	Ø6.3 × 7.7	16.0	7.0	7.0	12.0	7.5	8.0

2. Reel Dimension

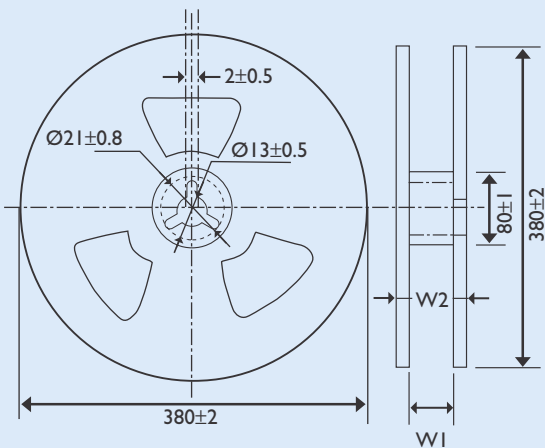

SIZE CODE	B	C	D	E	F	G
W1	14	14	18	18	26	26
W2	18	18	22	22	30	30



3. Details of Carrier Tape

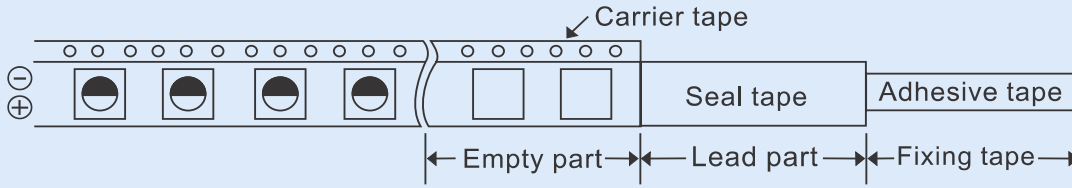

- (1)
 - a. Last reeling empty part of carrier tape shall be more than .10 cm
 - b. Leader part of seal tape shall be more than 20 cm.
 - c. First reeling Empty part of carrier tape shall be more than 10 cm
 - d. Adhesive tape fixing the end of the leader part shall be approx .10 cm

- (2) Deviation between carrier tape and seal tape
 - a. Deviation between carrier tape and seal tape shall be less than 0.5 mm.

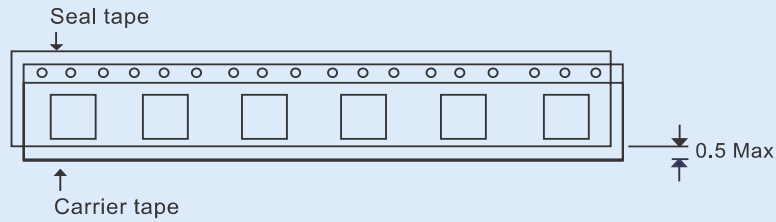

- b. Seal tape shall not cover on the feeding holes more than 0.75 mm.

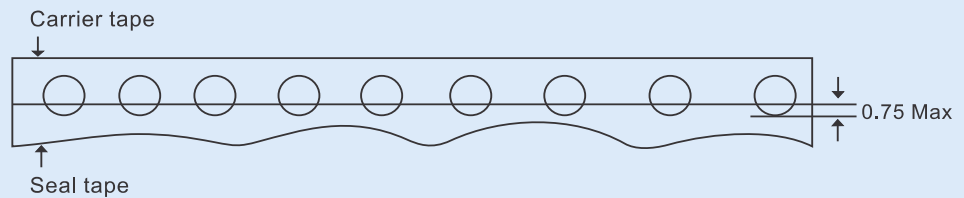

4. Adhesion Test

Reasonable pulling strength: 0.1~0.7N
Pulling speed: 300mm / min

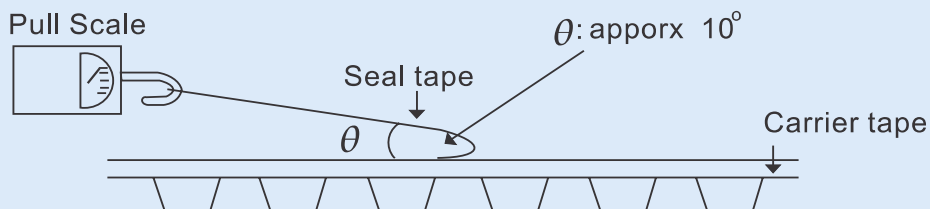

5. Packing Style

- (1) Carrier tape shall be reeled inside.(seal tape shall be outside)
- (2) End of the tape shall be inside to the reel physically as shown in the below figure and leader part of seal tape shall not be attached.

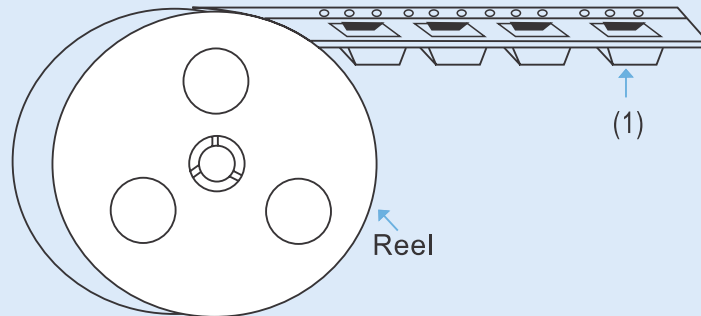

6. Packaging Quantity

Size Code	D x L	One Reel (pcs)	Total Quantity pcs)
B	4x5.4	2000	20000
C	5x5.4	1000	10000
D	6.3x5.4	1000	10000
E	6.3x7.7	1000	10000
F	8x6.2	1000	10000
G	8x10.2	500	3000
H	10x10.2	500	3000



Reflow soldering for chip capacitors

- (1) For reflow, use a thermal conduction system such as infrared radiation (IR) or hot blast. Vapor heat transfer systems (VPS) are not recommended.
- (2) Observe proper soldering conditions (temperature, time, etc.). Do not exceed the specified limits.
- (3) Reflow should be performed one time. Consult us for additional reflow restrictions.
- (4) Reflow soldering profile for standard :

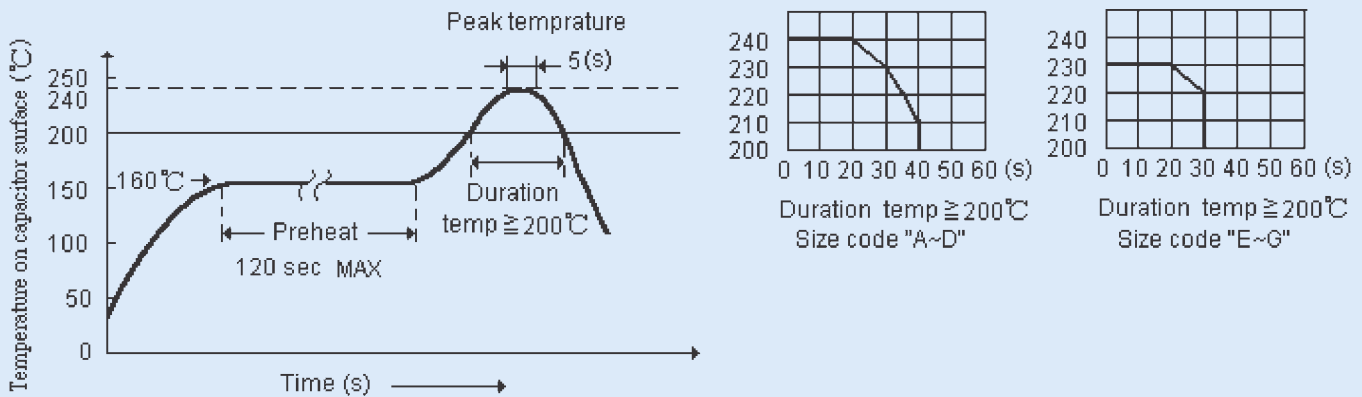

- (5) Reflow soldering profile for lead free :

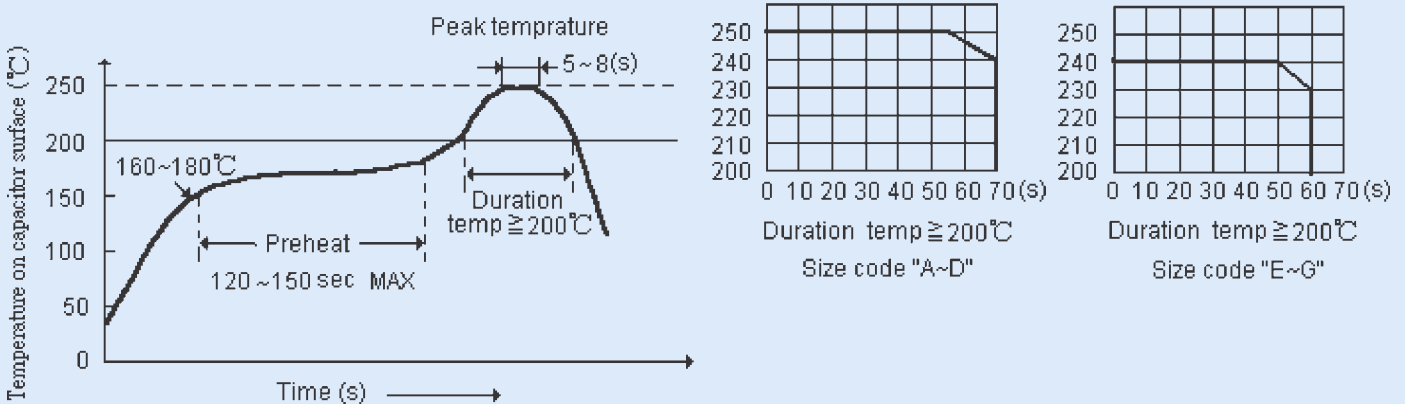

Manual Soldering

- (1) Observe temperature and time soldering specifications or do not exceed temperatures of 300°C for 3 seconds or less.
- (2) If a soldered capacitor must be removed and reinserted, avoid excessive stress on the capacitor leads.

Capacitor handling after soldering

- (1) Avoid moving the capacitor after soldering to prevent excessive stress on the lead wires where they enter the seal.
- (2) Do not use the capacitor as a handle when moving the circuit board assembly.
- (3) Avoid striking the capacitor after assembly to prevent failure due to excessive shock.

Miniature Size Aluminum Electrolytic Capacitors

ST [For Super Miniature]

85°C Single-Ended Lead, 5.0mm Height Type Aluminum Electrolytic Capacitors

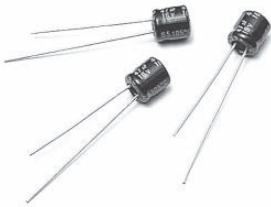

DESCRIPTION

This type is designed for saving space and high density insertion.

Applications : VTR, Camera, Car Audio, Mini Audio and Other Industrial and Commercial Applications

Cap(μF) \ Freq.(Hz)	50	120	300	1K	10K-
~47	0.75	1.00	1.35	1.57	2.00
100~300	0.80	1.00	1.23	1.34	1.50

Temperature coefficient

Temperature(°C)	-55	60	70	85
Factor	1.65	1.50	1.30	1.00

DIAGRAM OF DIMENSIONS

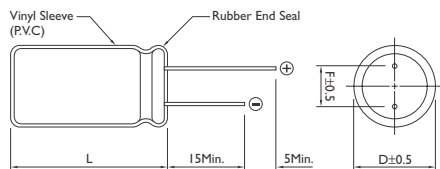

ELECTRICAL CHARACTERISTICS

Operating Temperature : -40° ~ +85°C

Working Voltage : 4 ~ 50V

Rate Capacitance Range : 0.1 ~ 330μF

Capacitance Tolerance : -20 ~ +20%

DC Leakage Current (μA) : I = 0.01CV (μA) or 3μA Whichever is greater.

(After 2 Minutes Application of DC Working Voltage at 25°C)

Dissipation Factor : at 120 Hz, 25°C

WV (V)	4	6.3	10	16	25	35	50
D.F (%)	40	38	30	23	17	15	13
	ø3	ø4~ø8	35	24	20	16	14
							12
							10

Load Life : 1000 Hours at 85°C Assured with Full Rated Maximum Ripple Current Applied

- (a) Capacitance Change : Within 20% of Initial Value
- (b) Dissipation Factor : Not Exceed 200% of Initial Requirement
- (c) Leakage Current : Not Exceed the Initial Requirement

Shelf Life : 500 Hours, No Voltage Applied, at 85°C

- (a) Capacitance Change : Within 20% of Initial Value
- (b) Dissipation Factor : Not Exceed 200% of Initial Requirement
- (c) Leakage Current : Not Exceed 200% of Initial Requirement

Dimensions : mm

Rubber Stand-off

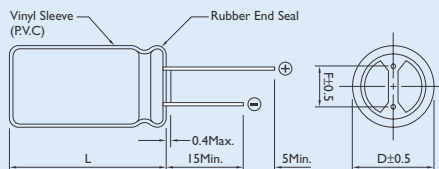

L ≤ 12 L + 1.5Max.
 13 ≤ L ≤ 15 L +1.0
 L -0.5
 L ≥ 16 L + 2.0Max.

Dø	F	dø
4.0	1.5	0.45
5.0	2.0	
6.3	2.5	
8.0	3.5	0.5



CASE SIZE & PERMISSIBLE RIPPLE CURRENT OF STANDARD PRODUCTS

CAP. (μF) RATED VOLTAGE WV

	4		6.3		10		16		25		35		50		
	Size	Ripple	Size	Ripple	Size	Ripple	Size	Ripple	Size	Ripple	Size	Ripple	Size	Ripple	
0.1													4 × 5	1.0	
0.22													4 × 5	2.0	
0.33													4 × 5	2.8	
0.47													4 × 5	4.0	
1.0													4 × 5	8.4	
2.2												3 × 5	8.4	4 × 5	13
3.3									3 × 5	10	4 × 5	15	4 × 5	17	
4.7							3 × 5	10	4 × 5	16	4 × 5	18	5 × 5	20	
10			3 × 5	15			4 × 5	23	5 × 5	27	5 × 5	29	6 × 5	33	
22	3 × 5	19	4 × 5	28	5 × 5	33	5 × 5	37	6 × 5	42	6 × 5	46	8 × 5	52	
33	4 × 5	28	4 × 5 5 × 5	37 37	5 × 5	41	6 × 5	49	6 × 5	52	8 × 5	62	8 × 5	71	
47	4 × 5	33	4 × 5 5 × 5	45 45	6 × 5	52	6 × 5	58	8 × 5	70	8 × 5	80			
100	5 × 5	56	6 × 5	70	8 × 5	80	8 × 5	92	8 × 5	110					
220	6 × 5	96	8 × 5	110	8 × 5	135									
330	8 × 5	145													

Note : * 1. D × L : mm

* 2. Size : 6 × 5 Actually is 6.3 × 5

* 3. mA rms at 85°C, 120Hz

Miniature Size Aluminum Electrolytic Capacitors

S7 [For Super Miniature]

85°C Single-Ended Lead, 5.0mm Height Type Aluminum Electrolytic Capacitors

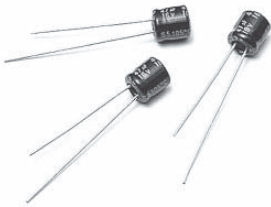

DESCRIPTION

This type is designed to meet the demand or equipments for greatly reduced size and thickness, such as: portable micro computer, disk driver, small calculator and audio equipment.

Frequency coefficient

Cap(μF) \ Freq.(Hz)	50	120	300	1K	10K-
~47	0.75	1.00	1.35	1.57	2.00
100~470	0.80	1.00	1.23	1.34	1.50

Temperature coefficient

Temperature(°C)	-55	60	70	85
Factor	1.65	1.50	1.30	1.00

DIAGRAM OF DIMENSIONS

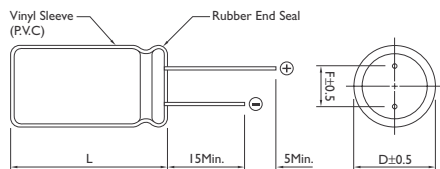

ELECTRICAL CHARACTERISTICS

Operating Temperature : -40° ~ +85°C

Working Voltage : 4 ~ 50V

Rate Capacitance Range : 0.1 ~ 470μF

Capacitance Tolerance : -20 ~ +20%

DC Leakage Current (μA) : I = 0.01 CV (μA) or 3μA Whichever is greater.

(After 2 Minutes Application of DC Working Voltage at 25°C)

Dissipation Factor : at 120 Hz, 25°C

WV (V) :	4	6.3	10	16	25	35	50
D.F (%) :	35	24	20	16	14	12	10

Load Life : 1000 Hours at 85°C Assured with Full Rated Maximum Ripple Current Applied

- (a) Capacitance Change : Within 20% of Initial Value
- (b) Dissipation Factor : Not Exceed 200% of Initial Requirement
- (c) Leakage Current : Not Exceed the Initial Requirement

Shelf Life : 500 Hours, No Voltage Applied, at 85°C

- (a) Capacitance Change : Within 20% of Initial Value
- (b) Dissipation Factor : Not Exceed 200% of Initial Requirement
- (c) Leakage Current : Not Exceed 200% of Initial Requirement

Dimensions : mm

Rubber Stand-off

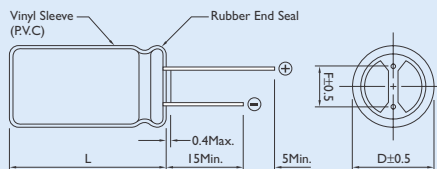

L ≤ 12 L + 1.5Max.
 13 ≤ L ≤ 15 L + 1.0
 L ≥ 16 L + 2.0Max.

Dø	F	dø
4.0	1.5	0.45
5.0	2.0	
6.3	2.5	
8.0	3.5	0.5



CASE SIZE & PERMISSIBLE RIPPLE CURRENT OF STANDARD PRODUCTS

CAP. (μF)	RATED VOLTAGE WV											
	6.3		10		16		25		35		50	
	Size	Ripple	Size	Ripple	Size	Ripple	Size	Ripple	Size	Ripple	Size	Ripple
0.1											4 × 7	10
0.22											4 × 7	2.3
0.33											4 × 7	3.5
0.47											4 × 7	5.0
1.0											4 × 7	10
2.2											4 × 7	19
3.3											4 × 7	24
4.7									4 × 7	24	4 × 7	28
10					4 × 7	28	4 × 7	28	4 × 7	31	5 × 7	38
22	4 × 7	34	4 × 7	35	4 × 7	39	5 × 7	48	5 × 7	52	6 × 7	58
33	4 × 7	40	4 × 7	43	5 × 7	59	5 × 7	58	6 × 7	65	8 × 7	75
47	4 × 7	48	5 × 7	59	5 × 7	65	6 × 7	71	8 × 7	85		
100	5 × 7	78	6 × 7	87	6 × 7	98	8 × 7	115				
220	6 × 7	120	8 × 7	145								
330	8 × 7	180	8 × 7	201								
470	8 × 7	215										

Note : * 1. D × L : mm

* 2. Size : 6 × 7 Actually is 6.3 × 7

* 3. mA rms at 85°C, 120Hz

Miniature Size Aluminum Electrolytic Capacitors

S5 [For Super Miniature]

105°C Single-Ended Lead, 5.0mm Height Type Aluminum Electrolytic Capacitors

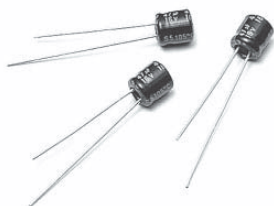

DESCRIPTION

The S5 series are smaller than SS series.

This type is designed for saving space and high density insertion.

Applications : VTR, Camera, Car Audio, Miniaudio and Other Industrial and Commercial Applications

Multiplier for Ripple Current

Frequency coefficient

Frequency (Hz)	20	300	1K	10K~100K
0.1~47μF	1.00	1.20	1.30	1.50
100~330μF	1.00	1.10	1.15	1.20

Temperature coefficient

Temperature(°C)	65	85	105
Factor	1.40	1.20	1.00

DIAGRAM OF DIMENSIONS

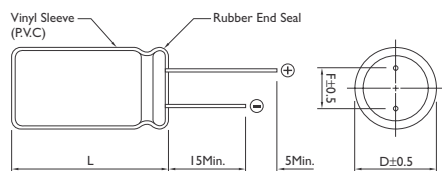

ELECTRICAL CHARACTERISTICS

Operating Temperature : -40° ~ +105°C

Working Voltage : 6.3 ~ 50V

Rate Capacitance Range : 0.1 ~ 470μF

Capacitance Tolerance : -20 ~ +20%

DC Leakage Current (μA) : I = 0.01 CV (μA) or 3μA Which ever is greater.

(After 2 Minutes Application of DC Working Voltage at 25°C)

Dissipation Factor : at 120 Hz, 25°C

WV (V) :	6.3	10	16	25	35	50
D.F (%) :	24	20	16	14	12	10

Load Life : 1000 Hours at 105°C Assured with Full Rated Maximum Ripple Current Applied

- (a) Capacitance Change : Within 20% of Initial Value
- (b) Dissipation Factor : Not Exceed 200% of Initial Requirement
- (c) Leakage Current : Not Exceed the Initial Requirement

Shelf Life : 500 Hours, No Voltage Applied, at 105°C

- (a) Capacitance Change : Within 20% of Initial Value
- (b) Dissipation Factor : Not Exceed 200% of Initial Requirement
- (c) Leakage Current : Not Exceed 200% of Initial Requirement

Dimensions : mm

Rubber Stand-off

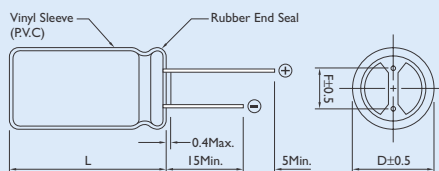

L ≤ 12 L + 1.5Max.
 13 ≤ L ≤ 15 L + 1.0
 L ≥ 16 L + 2.0Max.

Dø	F	dø
4.0	1.5	0.45
5.0	2.0	
6.3	2.5	
8.0	3.5	0.5



CASE SIZE & PERMISSIBLE RIPPLE CURRENT OF STANDARD PRODUCTS

CAP. (μF)	RATED VOLTAGE WV											
	6.3		10		16		25		35		50	
	Size	Ripple	Size	Ripple	Size	Ripple	Size	Ripple	Size	Ripple	Size	Ripple
0.1											4 × 5	1
0.22											4 × 5	2
0.33											4 × 5	3
0.47											4 × 5	4
1.0											4 × 5	9
2.2											4 × 5	13
3.3							4 × 5	13			4 × 5	17
4.7	4 × 5	16			4 × 5	20	4 × 5	16	4 × 5	18	4 × 5	17
											5 × 5	20
10	4 × 5	18	4 × 5	20	4 × 5	23	4 × 5	20	5 × 5	30	6 × 5	33
							5 × 5	27				
22	4 × 5	28	5 × 5	33	4 × 5	29	6 × 5	42	6 × 5	48	6.3 × 5	33
					5 × 5	37						
33	4 × 5	33	4 × 5	34	5 × 5	44	5 × 5	45				
			5 × 5	41	6 × 5	49	6 × 5	53				
47	4 × 5	35	5 × 5	46	5 × 5	54	5 × 5	55				
	5 × 5	45			6 × 5	58	6.3 × 5	65				
68			6 × 5	54								
100	5 × 5	55	6 × 5	80	6 × 5	85	8 × 5	90				
	6 × 5	70										
220	6 × 5	90	8 × 5	90								
330	8 × 5	115										
470	8 × 5	100										

Note : * 1. D × L : mm

* 2. Size : 6 × 5 Actually is 6.3 × 5

* 3. mA rms at 105°C, 120Hz

Miniature Size Aluminum Electrolytic Capacitors

SS [For Super Miniature]

105°C Single-Ended Lead Aluminum Electrolytic Capacitors

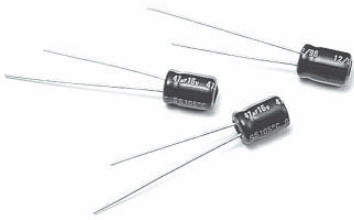

DESCRIPTION

This type is designed to meet the demand of equipments for greatly reduced size and thickness, such as: portable micro computer, disk driver, small calculator and audio equipment.

Application : Portable Micro Computer, Disk Driver, Small Calculator and Audio

Multiplier for Ripple Current

Frequency coefficient

Frequency (Hz)	50	120	300	1K	10K
0.1~47μF	0.75	1.00	1.20	1.30	1.50
100~330μF	0.75	1.00	1.10	1.15	1.20

Temperature coefficient

Temperature(°C)	65	85	105
Factor	1.70	1.30	1.00

DIAGRAM OF DIMENSIONS

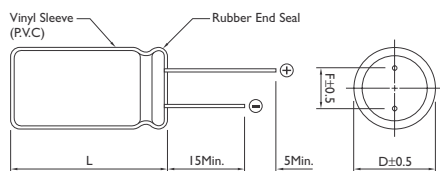

ELECTRICAL CHARACTERISTICS

Operating Temperature : -40° ~ +105°C

Working Voltage : 6.3 ~ 63V

Rate Capacitance Range : 0.1 ~ 470μF

Capacitance Tolerance : -20 ~ +20%

DC Leakage Current (μA) : I = 0.01 CV (μA) or 3μA Which ever is greater.

(After 2 Minutes Application of DC Working Voltage at 25°C)

Dissipation Factor : at 120 Hz, 25°C

WV (V):	6.3	10	16	25	35	50	63
D.F (%) :	24	20	17	15	12	10	8

Load Life : 1000 Hours at 105°C Assured with Full Rated Maximum Ripple Current Applied

- (a) Capacitance Change : Within 20% of Initial Value
- (b) Dissipation Factor : Not Exceed 200% of Initial Requirement
- (c) Leakage Current : Not Exceed the Initial Requirement

Shelf Life : 500 Hours, No Voltage Applied, at 105°C

- (a) Capacitance Change : Within 20% of Initial Value
- (b) Dissipation Factor : Not Exceed 200% of Initial Requirement
- (c) Leakage Current : Not Exceed 200% of Initial Requirement

Dimensions : mm

Rubber Stand-off

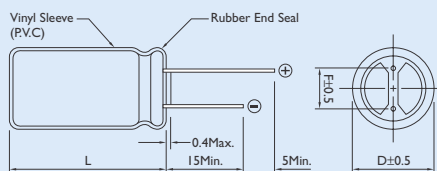

L ≤ 12 L + 1.5Max.
 13 ≤ L ≤ 15 L +1.0
 L -0.5
 L ≥ 16 L + 2.0Max.

Dø	F	dø
4.0	1.5	0.45
5.0	2.0	
6.3	2.5	
8.0	3.5	0.5



CASE SIZE & PERMISSIBLE RIPPLE CURRENT OF STANDARD PRODUCTS

CAP. (μF)	RATED VOLTAGE WV															
	6.3		10		16		25		35		50		63			
	Size	Ripple	Size	Ripple	Size	Ripple	Size	Ripple	Size	Ripple	Size	Ripple	Size	Ripple		
0.1											4 x 7	1	4 x 7	1		
0.22											4 x 7	2	4 x 7	2		
0.33											4 x 7	3	4 x 7	4		
0.47											4 x 7	5	4 x 7	6		
0.68											4 x 7	6				
1.0											4 x 7	10	4 x 7	13		
2.2					4 x 7	7					4 x 7	19	4 x 7	21		
3.3					4 x 7	13					4 x 7	24	4 x 7	26		
4.7					4 x 7	19	4 x 7	24	4 x 7	24	4 x 7	29	4 x 7	26		
									5 x 7	24	5 x 7	31	6 x 7	33		
			4 x 7		4 x 7	29	4 x 7	33	4 x 7	34	4 x 7	37	5 x 7	42		
10							5 x 7	35	5 x 7	36	5 x 7	45	6 x 7	50		
							6 x 7	35			6 x 7	45				
	4 x 7	37	4 x 7	31	4 x 7	36	4 x 7	43	5 x 7	48	6 x 7	65				
22			5 x 7	38	5 x 7	44	5 x 7	51	6 x 7	57						
							6 x 7	53								
	5 x 7	42	4 x 7	39	4 x 7	50	5 x 7	55	6 x 7	70						
33			5 x 7	47	5 x 7	57	6 x 7	55								
	4 x 7	46	4 x 7	50	5 x 7	75	5 x 7	67	6 x 7	81	8 x 7					
47	5 x 7	55	5 x 7	60	6 x 7	77	6 x 7	79								
			6 x 7	60												
68					5 x 7	84										
	5 x 7	75	5 x 7	85	5 x 7	94	6 x 7	120	8 x 7							
100	6 x 7	90	6 x 7	100	6 x 7	110	8 x 7	120								
150					6 x 7	120										
	6 x 7	130	6 x 7	135	8 x 7	140										
220					8 x 9	140										
330	8 x 7	140	8 x 7		8 x 9	155										
470	8 x 7		8 x 9	165												

Note : * 1. D x L : mm

* 2. Size : 6 x 7 Actually is 6.3 x 7

* 3. mA rms at 105°C, 120Hz

Miniature Size Aluminum Electrolytic Capacitors

SK [For General]

85°C Single-Ended Lead Aluminum Electrolytic Capacitors



DESCRIPTION

Lower-cost capacitors expressly intended for high density printed circuit board.

Very High Volumetric Efficiency

Ideally suited for general-purpose applications, decoupling, by pass, and filtering circuit in entertainment electronics.

Feature High CV Product with Moderate Cost

Multiplier for Ripple Current

Frequency coefficient

Frequency (Hz)	120	300	1K	10K~100K
6.3~100V Below~68μF	1.00	1.20	1.30	1.50
6.3~100V 100~680μF	1.00	1.10	1.15	1.20
6.3~110V 1000~22000μF	1.00	1.05	1.10	1.15
160~450V Below~220μF	1.00	1.25	1.40	1.40
160~450V 220μF Above	1.00	1.10	1.13	1.13

Temperature coefficient

Temperature(°C)	50	70	85
Factor	1.30	1.15	1.00

DIAGRAM OF DIMENSIONS

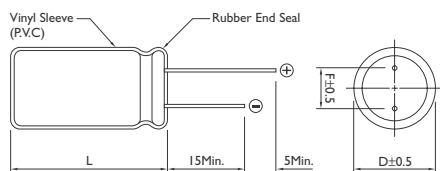

ELECTRICAL CHARACTERISTICS

Operating Temperature : -40° ~ +85°C / -25° ~ +85°C

Working Voltage : 6.3 ~ 100V / 160 ~ 450V

Rate Capacitance Range : 0.1 ~ 22000μF / 0.47 ~ 470μF

Capacitance Tolerance : -20 ~ +20%

DC Leakage Current (μA) : 0.01 CV or 3 μA / 0.03 CV +10 Whichever is greater.
(After 2 Minutes Application of DC Working Voltage at 25°C)

Dissipation Factor : at 120Hz, 25°C

WV (V):	6.3	10	16	25	35	50	63	100	160 ~ 250	350 ~ 450
D.F (%) :	22	19	16	14	12	10	9	8	15	20

For capacitor whose capacitance exceeds 1000μF. The value of DF(%) is increased by 2% for every addition of 1000μF.

Load Life : 2000 Hours at 85°C Assured with Full Rated Maximum Ripple Current Applied

- (a) Capacitance Change : Within 20% of Initial Value
- (b) Dissipation Factor : Not Exceed 200% of Initial Requirement
- (c) Leakage Current : Not Exceed the Initial Requirement

Shelf Life : 1000 Hours, No Voltage Applied at 85°C

- (a) Capacitance Change : Within 20% of Initial Value
- (b) Dissipation Factor : Not Exceed 200% of Initial Requirement
- (c) Leakage Current : Not Exceed 200% of Initial Requirement

Dimensions : mm

Rubber Stand-off

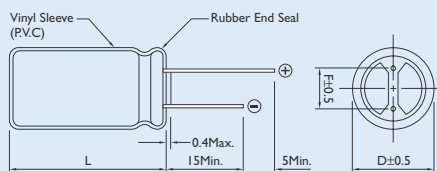

L ≤ 12 L + 1.5Max.
13 ≤ L ≤ 15 L +1.0 / -0.5
L ≥ 16 L + 2.0Max.

Dø	F	dø
4.0	1.5	0.45
5.0	2.0	0.5
6.0	2.5	
8.0	3.5	
10.0	5.0	0.6
12.0		
13.0		
16.0	7.5	0.8
18.0		
22.0	10.0	0.8



CASE SIZE & PERMISSIBLE RIPPLE CURRENT OF STANDARD PRODUCTS

CAP. (μF)	RATED VOLTAGE WV															
	6.3		10		16		25		35		50		63			
	Size	Ripple	Size	Ripple	Size	Ripple	Size	Ripple	Size	Ripple	Size	Ripple	Size	Ripple		
0.1											5 × 11	1				
0.22											5 × 11	2				
0.33											5 × 11	3	5 × 11	3		
0.47											5 × 11	5	5 × 11	5		
0.68											5 × 11	7				
1.0											5 × 11	10	5 × 11	10		
2.2											5 × 11	23	5 × 11	29		
3.3											5 × 11	35	5 × 11	40		
4.7			5 × 11	20	5 × 11	25	5 × 11	30	5 × 11	35	5 × 11	40	5 × 11	45		
6.8											5 × 11	50				
10			5 × 11	35	5 × 11	40	5 × 11	50	5 × 11	60	5 × 11	65	5 × 11	70		
15					5 × 11	50					5 × 11	80				
22	5 × 11	35	5 × 11	55	5 × 11	75	5 × 11	90	5 × 11	95	5 × 11	100	5 × 11	95		
33	5 × 11	55	5 × 11	80	5 × 11	110	5 × 11	115	5 × 11	120	5 × 11	105	6 × 11	115		
47	5 × 11	75	5 × 11	95	5 × 11	130	5 × 11	135	5 × 11	120	6 × 11	140	8 × 11	130		
68					5 × 11	150	5 × 11	135								
100	5 × 11	130	5 × 11	180	5 × 11	165	6 × 11	160	6 × 11	185	8 × 11	230	8 × 11	190		
					6 × 11	185			8 × 11	230	10 × 12	250	10 × 12	300		
220	5 × 11	200	5 × 11	180	6 × 11	260	8 × 11	290	10 × 12	370	10 × 12	380	10 × 15	410		
	6 × 11	240			8 × 11	320	10 × 12	340	10 × 15	370	10 × 15	440	10 × 19	490		
330	6 × 11	260	6 × 11	265	6 × 11	290	8 × 11	315	10 × 12	420	10 × 15	490	10 × 19	540		
	8 × 11	300	8 × 11	330	8 × 11	360			10 × 15	490	10 × 19	580	13 × 20	680		
							10 × 12	420								
470	6 × 11	330	6 × 11	320	8 × 11	400	8 × 15	420	10 × 15	430	10 × 19	610	13 × 20	755		
	8 × 11	380	8 × 11	440	10 × 12	470	10 × 12	460	10 × 19	510	13 × 20	760	13 × 25	880		
							10 × 15	540	13 × 12	640			16 × 25	8820		
680	8 × 11	410	10 × 12	460	10 × 12	510	10 × 15	540	13 × 20	705			13 × 25	965		
					10 × 15	565	10 × 19	595	13 × 25	780						
1000	8 × 11	460	10 × 12	580	10 × 15	630	10 × 19	760	13 × 20	950	13 × 25	1100	16 × 25	1310		
	10 × 12	580	10 × 15	630	10 × 19	790	12 × 16	760	13 × 25	1100	16 × 25	1350	16 × 32	1550		
							13 × 20	950								
1500			10 × 19	700					16 × 25	1240			18 × 36	2090		
2200	10 × 19	840	10 × 19	880	10 × 25	925	13 × 25	1300	16 × 25	1600	16 × 36	1850	18 × 40	2200		
	13 × 20	1050	13 × 20	1100	13 × 25	1350	16 × 25	1550	16 × 32	1800	18 × 36	2090	22 × 35	2200		
							18 × 20	1550								
3300	10 × 19	1000	13 × 20	1250	13 × 25	1400	16 × 25	1660	16 × 36	1970	18 × 36	2170	22 × 40	2500		
					16 × 25	1700	16 × 32	1950	18 × 36	2220	18 × 40	2400				
4700	13 × 20	1300	13 × 25	1500	16 × 25	1800	16 × 32	1950	18 × 36	2400	22 × 35	2240				
			16 × 25	1800	16 × 32	2100	18 × 36	2360			22 × 40	2500				
6800	16 × 25	1900	16 × 25	1900	16 × 32	1980	18 × 36	2550	22 × 40	2600						
			16 × 32	2150	16 × 36	2200										
					18 × 36	2500										
10000	16 × 25	1900	18 × 36	2500	18 × 36	2700	22 × 40	2800								
	16 × 32	2250														
15000	16 × 36	2500	18 × 36	2950	22 × 40	3150	22 × 40	3200								
22000	18 × 40	3650	22 × 40	3700	22 × 40	3800										

Note : * I. D × L : mm

* 2. mA rms at 85°C, 120Hz



CASE SIZE & PERMISSIBLE RIPPLE CURRENT OF STANDARD PRODUCTS

CAP. (μF)	RATED VOLTAGE WV													
	100		160		200		250		350		400		450	
	Size	Ripple	Size	Ripple	Size	Ripple	Size	Ripple	Size	Ripple	Size	Ripple	Size	Ripple
0.22	5 × 11	5												
0.47	5 × 11	10	5 × 11	12	5 × 11	14	5 × 11	14	5 × 11	14	6 × 11	14	6 × 11	14
1.0	5 × 11	21	5 × 11	17	5 × 11	19	5 × 11	17	6 × 11	19	6 × 11	16	8 × 11	19
			6 × 11	17			6 × 11	19			8 × 11	19		
2.2	5 × 11	30	6 × 11	26	6 × 11	22	6 × 11	24	8 × 11	33	8 × 11	26	10 × 12	33
			8 × 11	27	8 × 11	27	8 × 11	30	10 × 10	33	10 × 12	33		
3.3	5 × 11	45	6 × 11	30	6 × 11	30	8 × 11	30	8 × 11	33	10 × 12	40	10 × 15	42
			8 × 11	35	8 × 11	37	10 × 12	38	10 × 12	39				
4.7	5 × 11	50	6 × 11	32	8 × 11	36	8 × 11	36	10 × 12	39	8 × 15	33	10 × 15	50
			8 × 11	40	10 × 12	45	10 × 12	45	10 × 15	45	10 × 15	45	10 × 19	50
6.8	5 × 11	55					8 × 11	40					10 × 15	50
							10 × 12	50					10 × 19	56
10	5 × 11	65	8 × 11	50	10 × 12	57	10 × 15	70	10 × 15	70	10 × 15	50	10 × 19	56
	6 × 11	75	10 × 12	65	10 × 15	70	10 × 19	70	10 × 19	70	10 × 19	56	13 × 20	60
			10 × 15	65					13 × 20	70	13 × 20	70	13 × 25	75
15	8 × 11	93					10 × 19	75	10 × 19	90				
							13 × 20	90						
22	6 × 11	105	10 × 15	110	10 × 15	120	10 × 19	130	13 × 20	130	13 × 20	100	16 × 20	100
	8 × 11	130	10 × 19	110							13 × 25	110	16 × 25	110
											16 × 25	130	16 × 32	130
33	8 × 11	140	10 × 19	150	10 × 19	150	13 × 20	140	13 × 25	170	13 × 25	140	16 × 25	145
	10 × 12	170					13 × 25	160	16 × 25	170	16 × 20	145	16 × 32	160
											16 × 25	170	16 × 36	180
47	10 × 12	190	12 × 16	145	13 × 20	160	13 × 25	210	16 × 25	220	16 × 25	180	18 × 36	200
	10 × 15	230	12 × 25	180	13 × 25	190	16 × 25	210			16 × 32	220	18 × 40	230
			13 × 20	180							16 × 36	220		
68	10 × 15	280			13 × 25	230	16 × 25	210			16 × 32	220	18 × 32	265
100	10 × 19	400	13 × 25	250	16 × 25	330	16 × 32	310	16 × 36	320	18 × 36	360	22 × 40	370
			16 × 25	300					18 × 36	360	18 × 32	360		
150	13 × 20	500					18 × 40	410			18 × 40	410		
220	13 × 25	710	16 × 32	450	18 × 25	485	18 × 36	540						
			16 × 36	510	18 × 32	540	18 × 40	600						
					18 × 36	600								
330	13 × 25	720	18 × 36	540	16 × 40	710	18 × 40	600						
	16 × 25	860	18 × 40	600	16 × 45	750								
					18 × 32	685								
					18 × 36	725								
					18 × 40	800								
470	13 × 40	1100	22 × 40	900	18 × 40	750								
	16 × 25	1100			22 × 35	1000								
	16 × 32	1100												
680	16 × 36	1260												
1000	18 × 40	1350												
	22 × 35	1680												
2200	22 × 40	2300												

Note : * I. D × L : mm

* 2. mA rms at 85°C, 120Hz

SE-K [For General]

105°C Single-Ended Lead Aluminum Electrolytic Capacitors Rated Voltage up to 450V

Miniature Size Aluminum Electrolytic Capacitors

ELECTRICAL CHARACTERISTICS

Operating Temperature : -40° ~ +105°C / -25° ~ +105°C

Working Voltage : 6.3 ~ 250V / 350 ~ 450V

Rate Capacitance Range : 0.47 ~ 15000µF / 0.47 ~ 150µF

Capacitance Tolerance : -20 ~ +20%

DC Leakage Current (µA) : I = 0.01CV + 3 / 0.03CV + 10
(After 2 Minutes Application of DC Working Voltage at 25°C)

Dissipation Factor : at 120 Hz, 25°C

WV (V):	6.3	10	16	25	35	50	63	80	100	160 ~ 250	350 ~ 450
D.F (%) :	26	22	18	16	14	12	10	10	10	15	20

For capacitor whose capacitance exceeds 1000 µF. The value of DF(%) is increased by 2% for every addition of 1000 µF.

Load Life : 1000 Hours at Assured with Full Rated Maximum Ripple Current Applied

- (a) Capacitance Change : Within 20% of Initial Value
- (b) Dissipation Factor : Not Exceed 200% of Initial Requirement
- (c) Leakage Current : Not Exceed the Initial Requirement

Shelf Life : 500 Hours, No Voltage Applied

- (a) Capacitance Change : Within 20% of Initial Value
- (b) Dissipation Factor : Not Exceed 200% of Initial Requirement
- (c) Leakage Current : Not Exceed 200% of Initial Requirement

DIAGRAM OF DIMENSIONS

Dø	F	dø
4.0	1.5	0.45
5.0	2.0	0.5
6.0	2.5	
8.0	3.5	
10.0	5.0	0.6
12.0		
13.0		
16.0	7.5	0.8
18.0		
22.0	10.0	0.8

Rubber Stand-off

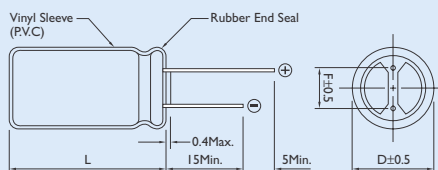

L ≤ 12 L + 1.5Max.
 13 ≤ L ≤ 15 L +1.0
 L -0.5
 L ≥ 16 L + 2.0Max.

DESCRIPTION

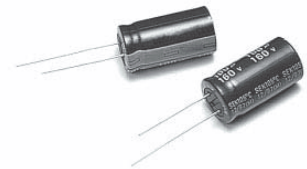

Lower-cost capacitors expressly intended for high density printed circuit board.

Very High Volumetric Efficiency

Ideally suited for general-purpose applications, coupling, decoupling, by pass, and filtering circuit in entertainment electronics.

Feature High CV Product with Moderate Cost

Multiplier for Ripple Current

Frequency coefficient

Frequency (Hz)	120	300	1K	10K~100K
6.3~100V Below~68µF	1.00	1.20	1.30	1.45
6.3~100V 100~680µF	1.00	1.10	1.15	1.25
6.3~110V 1000~22000µF	1.00	1.05	1.10	1.15
160~450V ALL Cap(µF)	1.00	1.05	1.10	1.50

Temperature coefficient

Temperature(°C)	65	85	105
Factor	1.80	1.40	1.00

Dimensions : mm

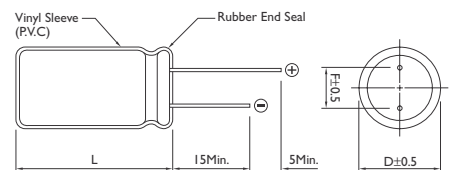



CASE SIZE & PERMISSIBLE RIPPLE CURRENT OF STANDARD PRODUCTS

CAP. (μF)	RATED VOLTAGE WV															
	6.3		10		16		25		35		50		63			
	Size	Ripple	Size	Ripple	Size	Ripple	Size	Ripple	Size	Ripple	Size	Ripple	Size	Ripple		
0.47											5 × 11	7	5 × 11	8		
1.0											5 × 11	12	5 × 11	13		
2.2											5 × 11	18	5 × 11	20		
3.3											5 × 11	25	5 × 11	27		
4.7							5 × 11	20	5 × 11	25	5 × 11	30	5 × 11	34		
6.8							5 × 11	25	5 × 11	30	5 × 11	32	5 × 11	37		
10					5 × 11	25	5 × 11	30	5 × 11	40	5 × 11	50	5 × 11	55		
15					5 × 11	40	5 × 11	45	5 × 11	50	5 × 11	60	5 × 11	65		
22			5 × 11	45	5 × 11	55	5 × 11	60	5 × 11	65	5 × 11	75	6 × 11	90		
33			5 × 11	60	5 × 11	70	5 × 11	75	5 × 11	85	6 × 11	105	6 × 11	110		
													8 × 11	120		
47	5 × 11	60	5 × 11	75	5 × 11	85	5 × 11	90	5 × 11	95	6 × 11	100	8 × 11	155		
									6 × 11	115	8 × 11	125				
68	5 × 11	75	5 × 11	80	5 × 11	100	6 × 11	125	8 × 11	130	8 × 11	159	10 × 12	198		
100	5 × 11	100	5 × 11	110	5 × 11	110	6 × 11	145	6 × 11	150	8 × 11	160	8 × 15	230		
							6 × 11	135	8 × 11	190	10 × 12	210	10 × 12	260		
150	5 × 11	120	5 × 11	110	8 × 11	180	8 × 11	200	10 × 12	240	10 × 12	289	10 × 15	330		
			6 × 11	130												
220	5 × 11	140	6 × 11	180	6 × 11	180	8 × 11	200	8 × 11	230	10 × 12	340	10 × 15	400		
	6 × 11	165			8 × 11	235	10 × 12	250	8 × 15	280	10 × 15	400	10 × 19	460		
									10 × 12	315						
330	6 × 11	160	6 × 11	205	8 × 11	285	8 × 11	265	8 × 15	345	10 × 15	450	10 × 19	520		
	8 × 11	200	8 × 11	255			8 × 15	320	8 × 20	420	10 × 19	535	13 × 20	650		
							10 × 12	355	10 × 12	380						
									10 × 15	440						
470	6 × 11	220	6 × 11	245	8 × 11	310	8 × 15	365	10 × 15	415	10 × 19	580	13 × 20	700		
	8 × 11	280	8 × 11	305	8 × 15	360	10 × 12	400	10 × 19	490	13 × 20	730	13 × 25	800		
					10 × 12	395	10 × 15	470	13 × 20	580						
680	8 × 11	255	8 × 11	335	10 × 12	455	10 × 19	650	13 × 20	730	13 × 25	860	13 × 25	840		
	10 × 12	320	8 × 15	385	10 × 15	530							16 × 25	1000		
			10 × 12	420												
1000	8 × 11	370	8 × 11	390	8 × 20	600	10 × 19	680	13 × 20	850	13 × 25	930	16 × 25	1020		
	10 × 12	470	8 × 15	450	10 × 15	590	12 × 20	775	13 × 25	995	16 × 25	1110	16 × 32	1200		
			10 × 12	490	10 × 19	700	13 × 20	855								
			10 × 15	570												
1500	10 × 15	600	10 × 19	750	10 × 19	680	13 × 25	1020	13 × 25	935	16 × 32	1350	16 × 32	1300		
					13 × 20	860			16 × 25	1110			16 × 36	1450		
2200	10 × 19	740	10 × 19	800	10 × 25	895	13 × 25	1030	16 × 25	1230	16 × 36	1360	18 × 36	1455		
	13 × 20	930	13 × 20	1010	12 × 25	1040	16 × 25	1230	16 × 32	1450	18 × 36	1530				
					13 × 20	990										
					13 × 25	1150										
3300	10 × 19	880	10 × 25	950	13 × 25	1140	13 × 25	1035	16 × 36	1470	18 × 36	1540				
	13 × 20	1100	10 × 30	1090	16 × 25	1350	16 × 25	1230	18 × 36	1660	18 × 40	1700				
			13 × 20	1050			16 × 32	1450								
			13 × 25	1220												
4700	13 × 25	1100	13 × 25	1190	16 × 25	1330	16 × 32	1420	18 × 36	1580	22 × 35	1900				
	16 × 25	1320	16 × 25	1410	16 × 32	1560	18 × 36	1690	18 × 40	1750						
6800	13 × 25	1250	16 × 25	1370	16 × 36	1590	18 × 36	1850	22 × 40	1885						
	16 × 25	1490	16 × 32	1610	16 × 40	1670										
					18 × 36	1790										
10000	16 × 25	1560	16 × 36	1760	18 × 36	2100										
	16 × 32	1830	18 × 36	1980												
15000	18 × 36	2280	18 × 40	1960												

Note : * I. D × L : mm

* 2. mA rms at 85°C, 120Hz



CASE SIZE & PERMISSIBLE RIPPLE CURRENT OF STANDARD PRODUCTS

CAP. (μF)	RATED VOLTAGE WV													
	100		160		200		250		350		400		450	
	Size	Ripple	Size	Ripple	Size	Ripple	Size	Ripple	Size	Ripple	Size	Ripple	Size	Ripple
0.47	5 × 11	10	5 × 11	12	5 × 11	14	5 × 11	14	5 × 11	14	6 × 11	14	6 × 11	14
1.0	5 × 11	15	5 × 11	17	5 × 11	19	6 × 11	19	6 × 11	20	6 × 11	16	8 × 11	20
											8 × 11	20		
2.2	5 × 11	22	6 × 11	25	6 × 11	22	6 × 11	23	8 × 11	35	8 × 11	28	10 × 12	35
						8 × 11	28	8 × 11	29		10 × 12	35		
3.3	5 × 11	29	6 × 11	30	6 × 11	32	8 × 11	33	8 × 11	37	8 × 11	38	10 × 15	54
			8 × 11	36	8 × 11	40	10 × 12	42	10 × 12	47	10 × 12	50		
4.7	5 × 11	37	6 × 11	34	8 × 11	40	8 × 11	41	10 × 12	47	8 × 15	45	10 × 15	60
			8 × 11	43	10 × 12	50	10 × 12	52	10 × 15	55	10 × 12	49		
											10 × 15	57		
6.8	5 × 11	46	10 × 12	54	10 × 12	60	8 × 15	57	10 × 15	65	10 × 15	60	10 × 19	80
							10 × 12	62			10 × 19	72		
10	5 × 11	55	8 × 11	56	10 × 12	69	10 × 15	88	10 × 15	95	10 × 15	65	13 × 20	85
	6 × 11	65	10 × 12	70	10 × 15	80					10 × 19	77	13 × 25	100
											13 × 20	97		
15	8 × 11	82	10 × 15	90	10 × 15	110	10 × 15	120	10 × 19	140	10 × 19	100	16 × 25	160
											13 × 20	125		
											13 × 25	150		
22	8 × 11	115	8 × 20	125	10 × 15	140	10 × 19	155	13 × 20	165	13 × 20	150	13 × 25	125
			10 × 15	130							13 × 25	175	16 × 25	150
													16 × 32	180
33	8 × 11	120	10 × 19	180	10 × 19	190	13 × 20	170	13 × 25	220	13 × 25	190	16 × 25	190
	10 × 12	160					13 × 25	200			16 × 20	195	16 × 36	240
											16 × 25	230		
47	10 × 12	180	13 × 20	270	13 × 20	240	13 × 25	330	16 × 25	340	16 × 25	280	16 × 36	300
	10 × 15	210			13 × 25	290					16 × 32	315	18 × 40	360
											16 × 36	350		
											18 × 20	275		
											18 × 25	300		
68	10 × 15	241	13 × 25	300	13 × 25	330	16 × 25	350	16 × 32	370	16 × 32	320	18 × 32	305
											16 × 36	335	22 × 40	400
											18 × 25	305		
											18 × 36	380		
100	10 × 19	385	13 × 25	330	13 × 25	340	16 × 32	430	18 × 36	460	16 × 36	425		
			16 × 25	400	16 × 25	410					18 × 32	430		
											18 × 36	480		
120											18 × 36	480		
150	13 × 25	414	16 × 32	435	16 × 36	450	18 × 40	460	22 × 40	480	22 × 40	450		
220	13 × 25	590	16 × 32	550	18 × 32	520	22 × 40	680						
			16 × 36	620	18 × 36	580								
					18 × 40	650								
330	13 × 25	600	18 × 36	770	18 × 36	705								
	16 × 25	720	18 × 40	850	18 × 40	780								
					22 × 40	920								
470	16 × 25	740	22 × 40	980										
	16 × 32	875												
680	16 × 36	1200												
1000	18 × 40	1340												
	22 × 40	1500												

Note: * I. D × L : mm

* 2. mA rms at 105°C, 120Hz

Miniature Size Aluminum Electrolytic Capacitors

SH [For General]

105°C Single-Ended Lead Aluminum Electrolytic Capacitors
for the Rated Voltage up to 450V

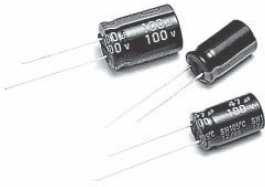

DESCRIPTION

Long life for 2,000 hours at 105°C, ideally suited for high quality and high reliability applications.

Feature High CV Product

Multiplier for Ripple Current

Frequency coefficient

Frequency (Hz)	120	300	1K	10K~100K
6.3~100V Below~68μF	1.00	1.30	1.57	2.00
6.3~100V 100~470μF	1.00	1.23	1.34	1.50
6.3~100V 471~22000μF	1.00	1.10	1.13	1.15
160~450V ALL Cap(μF)	1.00	1.25	1.40	1.60

Temperature coefficient

Temperature(°C)	65	85	105
Factor	1.70	1.40	1.00

DIAGRAM OF DIMENSIONS

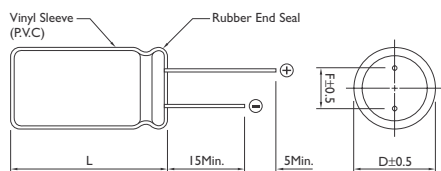

ELECTRICAL CHARACTERISTICS

Operating Temperature : -40° ~ +105°C / -25° ~ +105°C

Working Voltage : 6.3 ~ 100V / 160 ~ 450V

Rate Capacitance Range : 0.47 ~ 15000μF / 0.47 ~ 470μF

Capacitance Tolerance : -20 ~ +20%

DC Leakage Current (μA) : 0.01CV + 3 / 0.03CV + 10

(After 2 Minutes Application of DC Working Voltage at 25°C)

Dissipation Factor : at 120 Hz, 25°C

WV (V) :	6.3	10	16	25	35	50	63 ~ 100	160 ~ 250	350 ~ 450
D.F (%) :	26	22	18	16	14	12	10	15	20

For capacitor whose capacitance exceeds 1000μF. The value of DF(%) is increased by 2% for every addition of 1000μF.

WV (V) :	6.3	10	16	25	35 ~ 100	160 ~ 250	350 ~ 450
Impedance : Z - 25°C / Z + 25°C	4	3	2	2	2	4	4
Z - 40°C / Z + 20°C	8	6	4	3	3	6	8

Load Life : 2000 Hours at 105°C Assured with Full Rated Maximum Ripple Current Applied

- (a) Capacitance Change : Within 20% of Initial Value
- (b) Dissipation Factor : Not Exceed 200% of Initial Requirement
- (c) Leakage Current : Not Exceed the Initial Requirement

Shelf Life : 1000 Hours, No Voltage Applied

- (a) Capacitance Change : Within 20% of Initial Value
- (b) Dissipation Factor : Not Exceed 200% of Initial Requirement
- (c) Leakage Current : Not Exceed 200% of Initial Requirement

Dimensions : mm

Rubber Stand-off

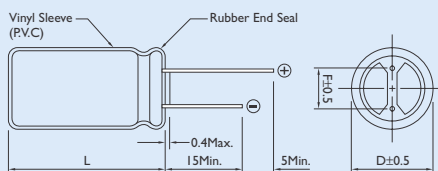

L ≤ 12 L + 1.5Max.
13 ≤ L ≤ 15 L + 1.0
L ≥ 16 L + 2.0Max.

Dø	F	dø
4.0	1.5	0.45
5.0	2.0	0.5
6.0	2.5	
8.0	3.5	
10.0	5.0	0.6
12.0		
13.0		
16.0	7.5	0.8
18.0		
22.0	10.0	0.8



CASE SIZE & PERMISSIBLE RIPPLE CURRENT OF STANDARD PRODUCTS

CAP. (μF)	RATED VOLTAGE WV															
	6.3		10		16		25		35		50		63			
	Size	Ripple	Size	Ripple	Size	Ripple	Size	Ripple	Size	Ripple	Size	Ripple	Size	Ripple		
0.47											5 × 11	7	5 × 11	8		
1.0											5 × 11	12	5 × 11	12		
2.2											5 × 11	18	5 × 11	20		
3.3											5 × 11	25	5 × 11	27		
4.7											5 × 11	30	5 × 11	34		
6.8											5 × 11	30	5 × 11	37		
10									5 × 11	44	5 × 11	50	5 × 11	55		
15									5 × 11	50	5 × 11	50	5 × 11	65		
22							5 × 11	60	5 × 11	65	5 × 11	75	6 × 11	90		
33					5 × 11	70	5 × 11	75	5 × 11	85	6 × 11	105	8 × 11	110		
47			5 × 11	75	5 × 11	85	5 × 11	90	6 × 11	115	8 × 11	125	8 × 11	155		
68			5 × 11	80	5 × 11	100	6 × 11	125	8 × 11	130	8 × 11	159	10 × 12	198		
100	5 × 11	100	5 × 11	110	6 × 11	135	6 × 11	145	8 × 11	190	10 × 12	210	10 × 12	260		
150	5 × 11	120	6 × 11	130	8 × 11	180	8 × 11	200	10 × 12	240	10 × 12	289	10 × 15	330		
220	6 × 11	165	6 × 11	180	6 × 11	180	10 × 12	250	10 × 12	315	10 × 15	400	10 × 19	465		
					8 × 11	235										
330	8 × 11	200	8 × 11	255	10 × 12	285	10 × 12	355	10 × 15	440	10 × 19	535	13 × 20	650		
470	8 × 11	280	8 × 11	305	8 × 11	315	10 × 15	470	10 × 19	460	13 × 20	730	13 × 25	800		
					10 × 12	395			13 × 20	580						
680	10 × 12	320	10 × 12	420	10 × 15	530	10 × 19	650	13 × 20	730	13 × 25	860	16 × 25	1000		
1000	10 × 12	470	10 × 12	490	10 × 19	700	13 × 20	855	13 × 25	995	16 × 25	1110	16 × 32	1200		
			10 × 15	570												
1500	10 × 15	600	10 × 19	750	13 × 20	860	13 × 25	1020	16 × 25	1110	16 × 32	1350	18 × 40	1450		
2200	13 × 20	930	10 × 19	800	13 × 25	1150	16 × 25	1230	16 × 32	1450	18 × 36	1530				
			13 × 20	1010												
3300	13 × 20	1100	13 × 25	1220	16 × 25	1350	16 × 32	1450	18 × 36	1660						
4700	16 × 25	1320	16 × 25	1410	16 × 25	1330	18 × 36	1690								
					16 × 32	1560										
6800	16 × 25	1490	16 × 32	1610	18 × 36	1790										
10000	16 × 32	1830	18 × 36	1980												
15000	18 × 36	2280														

Note : * 1. D × L : mm

* 2. mA rms at 105°C, 120Hz



CASE SIZE & PERMISSIBLE RIPPLE CURRENT OF STANDARD PRODUCTS

CAP. (μF)	RATED VOLTAGE WV													
	100		160		200		250		350		400		450	
	Size	Ripple	Size	Ripple	Size	Ripple	Size	Ripple	Size	Ripple	Size	Ripple	Size	Ripple
0.47	5 × 11	10	5 × 11	12	5 × 11	12	5 × 11	12	6 × 11	14	6 × 11	14	6 × 11	16
1.0	5 × 11	15	5 × 11	17	6 × 11	17	6 × 11	17	8 × 11	20	8 × 11	20	8 × 11	22
2.2	5 × 11	22	6 × 11	25	6 × 11	25	8 × 11	29	10 × 12	35	10 × 12	35	10 × 12	37
3.3	5 × 11	29	8 × 11	36	8 × 11	36	10 × 12	42	10 × 15	47	10 × 12	42	10 × 15	51
											10 × 15	49		
4.7	5 × 11	37	8 × 11	43	10 × 12	50	10 × 12	52	10 × 15	55	10 × 15	57	10 × 15	59
6.8	5 × 11	46	10 × 12	54	10 × 12	60	10 × 12	62	10 × 19	65	10 × 15	67	13 × 20	69
10	6 × 11	65	10 × 12	70	10 × 15	80	10 × 15	75	13 × 20	95	10 × 19	75	13 × 25	99
							10 × 19	88			13 × 20	97		
15	8 × 11	82	10 × 15	90	10 × 19	110	13 × 20	120	13 × 20	140	13 × 25	145	16 × 25	150
	8 × 11	115	10 × 15	130	10 × 15	140	13 × 20	130	16 × 25	165	13 × 20	120	16 × 25	145
22							13 × 25	155			13 × 25	140	16 × 32	175
											16 × 25	170		
33	10 × 12	160	13 × 20	180	13 × 20	160	13 × 25	200	16 × 32	195	16 × 25	190	18 × 36	250
					13 × 25	190					16 × 32	230		
47	10 × 15	210	13 × 25	250	13 × 20	220	16 × 25	270	16 × 36	210	16 × 25	200	18 × 40	350
					13 × 25	260			18 × 36	240	16 × 32	250		
											18 × 36	300		
68	10 × 15	241	13 × 25	270	16 × 25	280	16 × 32	300	16 × 36	320	18 × 36	325	22 × 40	380
100	10 × 19	305	16 × 25	390	16 × 32	400	18 × 36	440	18 × 40	300	18 × 36	290		
	13 × 20	385							22 × 40	360	22 × 40	365		
120											18 × 36	320		
											18 × 40	350		
150	13 × 25	414	16 × 32	435	16 × 36	450	18 × 40	600	22 × 40	480	22 × 40	465		
220	13 × 25	495	16 × 36	700	18 × 36	675	22 × 40	800						
	16 × 25	590			18 × 40	750								
330	16 × 25	720	18 × 40	850	18 × 40	780								
					22 × 40	920								
470	16 × 32	875	22 × 40	980										
680	16 × 36	1200												

Note : * I. D × L : mm

* 2. mA rms at 105°C, 120Hz

SG [Electronic Ballast]

105°C Single-Ended Lead Aluminum Electrolytic Capacitors

Miniature Size Aluminum Electrolytic Capacitors

ELECTRICAL CHARACTERISTICS

Operating Temperature : -40 ~ +105°C / -25 ~ +105°C

Working Voltage : 160 ~ 400V / 450V

Rate Capacitance Range : 4.7 ~ 330μF / 3.3~100μF

Capacitance Tolerance : -20 ~ +20%

DC Leakage Current (μA) : I = 0.06 CV + 10

(After 2 Minute Application of DC Working Voltage at 25°C)

Dissipation Factor : at 120 Hz, 25°C

WV (V) :	160	200	250	350	400	450
D.F (%) :	15	15	15	20	24	24

For capacitor whose capacitance exceeds 1000μF. The value of D.F(%) is increased by 2% for every addition of 1000μF.

Load Life : 5000 Hours at Assured with Full Rated Maximum Ripple Current Applied

(a) Capacitance Change : Within 20% of Initial Value

(b) Dissipation Factor : Not Exceed 200% of Initial Requirement

(c) Leakage Current : Not Exceed the Initial Requirement

Shelf Life : Hours, No Voltage Applied

(a) Capacitance Change : Within 20% of Initial Value

(b) Dissipation Factor : Not Exceed 200 % of Initial Requirement

(c) Leakage Current : Not Exceed 200% of Initial Requirement

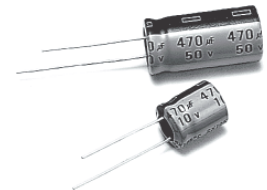

Multiplier for Ripple Current

Frequency coefficient

Frequency (Hz)	50,60	120	300	1K	10K~100K
6.3~100V Below~68μF	0.80	1.00	1.20	1.40	1.6

Temperature coefficient

Temperature(°C)	65	85	105
Factor	1.70	1.40	1.00

DIAGRAM OF DIMENSIONS

Dimensions : mm

Dø	F	dø
4.0	1.5	0.45
5.0	2.0	0.5
6.0	2.5	
8.0	3.5	
10.0	5.0	0.6
12.0		
13.0		
16.0	7.5	0.8
18.0		
22.0	10.0	0.8

Rubber Stand-off

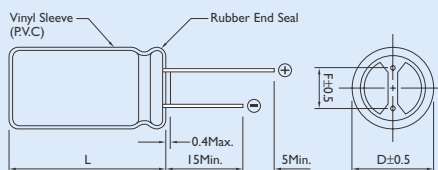

$L \leq 12$ $L + 1.5\text{Max.}$
 $13 \leq L \leq 15$ $L^{+1.0}_{-0.5}$
 $L \geq 16$ $L + 2.0\text{Max.}$

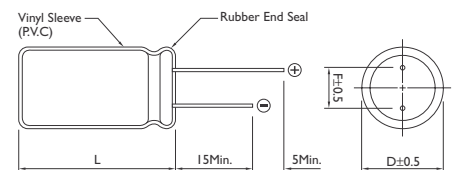



CASE SIZE OF STANDARD PRODUCTS

CAP. (μF)	RATED VOLTAGE								
	SIZE	160 Ripple	Impedance	SIZE	200 Ripple	Impedance	SIZE	250 Ripple	Impedance
10				*10 × 15	100	2.50	*10 × 15	85	4.10
							10 × 19	100	3.50
15				*10 × 15	80	5.00			
22	10 × 19	160	1.52	10 × 19	160	1.50	*10 × 25	145	2.75
							13 × 20	160	2.50
33	10 × 19	210	1.30	*10 × 19	160	1.20	13 × 20	210	1.90
				13 × 20	210	0.95			
47	13 × 20	260	0.95	13 × 20	260	0.91	13 × 25	270	1.70
							16 × 20	275	1.50
68	13 × 25	360	0.60	13 × 25	360	0.60	16 × 25	380	0.80
	16 × 20	430	0.55	16 × 20	430	0.55	18 × 20	375	0.90
100	16 × 25	475	0.30	16 × 25	475	0.30	16 × 32	520	0.65
	18 × 20	465	0.31	18 × 20	465	0.31	18 × 25	500	0.65
150	16 × 32	650	0.22	18 × 25	650	0.27	18 × 32	650	0.45
	18 × 25	625	0.24						
220	16 × 32	750	0.22	18 × 32	780	0.22	18 × 40	820	0.35
	18 × 25	725	0.24						
330	18 × 32	960	0.22						

Note : * I. D × L : mm

* 2. mA rms at 105°C, 100KHz

* 3. Impedance Spec : 100KHz / 25°C (Ω MAX)

* 4. Down Size : 3000Hrs



CASE SIZE OF STANDARD PRODUCTS

CAP. (μF)	RATED VOLTAGE								
	SIZE	350		SIZE	400		SIZE	450	
		Ripple	Impedance		Ripple	Impedance		Ripple	Impedance
3.3							10 × 19	60	6.50
4.7				*10 × 15	60	3.50	13 × 20	80	3.60
6.8				*10 × 15	72	3.40	*10 × 19	90	3.40
10	10 × 19	100	3.00	10 × 19	100	2.90	13 × 20	110	3.00
22	13 × 20	160	2.10	13 × 25	170	1.35	16 × 25	190	1.80
				16 × 20	200	1.00	18 × 20	200	2.20
33	13 × 25	230	1.00	16 × 25	230	0.95	16 × 32	275	1.30
	16 × 20	250	0.91	18 × 20	250	0.91	18 × 25	280	1.20
47	16 × 25	300	0.75	16 × 32	300	0.75	18 × 32	340	1.00
	18 × 20	315	0.80	18 × 25	325	0.80			
68	16 × 32	400	0.50	18 × 36	420	0.49	18 × 40	460	0.80
	18 × 25	380	0.55						
100	18 × 32	530	0.40	18 × 40	545	0.34	22 × 40	580	0.60
150				22 × 40	650	0.30			

Note : * 1. D × L : mm

* 2. mA rms at 105°C, 100KHz

* 3. Impedance Spec : 100KHz / 25°C (Ω MAX)

* 4. Down Size : 3000Hrs

Miniature Size Aluminum Electrolytic Capacitors

SA [High Ripple Current and Long load life]

105°C Single-Ended Lead Aluminum Electrolytic Capacitors

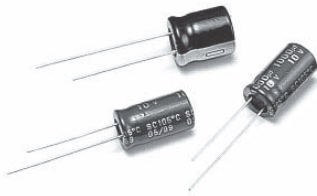

DESCRIPTION

High Temperature Load Life at 105°C for 3000~8000 Hours

Frequency coefficient

Rated voltage(V)	Freq.(Hz) Cap(μF)	Cap(μF)				
		50	120	300	1K	10K-
6.3~100V	-47	0.75	1.00	1.35	1.57	2.00
	100~470	0.80	1.00	1.23	1.34	1.50
	≥560	0.85	1.00	1.10	1.13	1.15
160~450	0.47~220	0.80	1.00	1.25	1.40	1.60
	≥270	0.90	1.00	1.10	1.13	1.15

Temperature coefficient

Temperature(°C)	~55	60	70	85	105
Factor	2.23	2.17	2.00	1.75	1.00

DIAGRAM OF DIMENSIONS

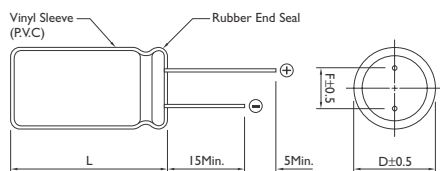

ELECTRICAL CHARACTERISTICS

Operating Temperature : -40° ~ +105°C -25° ~ +105°C

Working Voltage : 6.3 ~ 100V 160 ~ 450V

Rate Capacitance Range : 0.1 ~ 22000μF

Capacitance Tolerance : -20 ~ +20%

DC Leakage Current (μA) : $I \leq 0.03 CV$ or $4(\mu A)$ after 1 minute, $I \leq 0.04 CV + 40(\mu A)$ after 1 minute (Measurements shall be Made After a 1 Minute Charge at Rated Working Voltage)

Dissipation Factor : at 120 Hz, 25°C

WV (V)	6.3	10	16	25	35	50	63	100	160	200	250	315	400	450
D.F (%)	28	24	20	16	14	12	10	8	20	20	20	25	25	25

For capacitor whose capacitance exceeds 1000μF. The value of D.F(%) is increased by 2% for every addition of 1000μF.

WV (V)	6.3	10	16	25	35	50	63	100
Impedance : Z - 25°C / Z + 20°C	5	4	3	2	2	2	2	2
Impedance : Z - 40°C / Z + 20°C	12	10	8	5	4	3	3	3

WV (V)	160	200	250	350	400	450
Impedance : Z - 25°C / Z + 20°C	3	3	4	4	6	15

Load Life : At 105°C Assured with Full Rated Maximum Ripple Current Applied

ø5~ø6=3000 hours.

ø8~ø10=5000 hours.

>ø12=8000 hours.

(a) Capacitance Change : Within 20% of Initial Value

(b) Dissipation Factor : Not Exceed 200% of Initial Requirement

(c) Leakage Current : Not Exceed the Initial Requirement

Shelf Life : 1000 Hours, No Voltage Applied, at 105°C

(a) Capacitance Change : Within 20% of Initial Value

(b) Dissipation Factor : Not Exceed 200 % of Initial Requirement

(c) Leakage Current : Not Exceed 200% of Initial Requirement

Dimensions : mm

Rubber Stand-off

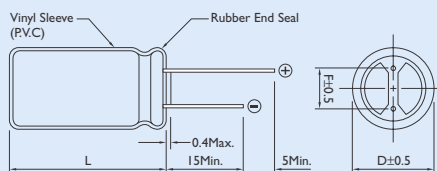

$L \leq 12$ $L + 1.5\text{Max.}$
 $13 \leq L \leq 15$ $L^{+1.0}_{-0.5}$
 $L \geq 16$ $L + 2.0\text{Max.}$

Dø	F	dø
4.0	1.5	0.45
5.0	2.0	0.5
6.0	2.5	
8.0	3.5	
10.0	5.0	0.6
12.0		
13.0		
16.0	7.5	0.8
18.0		
22.0	10.0	0.8



CASE SIZE OF STANDARD PRODUCTS $D\phi \geq 6\text{mm}$ with Safety Vent at Can Bottom

CAP. (μF)	RATED VOLTAGE WV									
	6.3		10		16		25		35	
	Size	Ripple	Size	Ripple	Size	Ripple	Size	Ripple	Size	Ripple
0.1										
0.22										
0.33										
0.47										
1										
2.2										
3.3										
4.7							5 x 11	18	5 x 11	21
10					5 x 11	24	5 x 11	30	5 x 11	33
22	5 x 11	21	5 x 11	33	5 x 11	45	5 x 11	48	5 x 11	51
33	5 x 11	33	5 x 11	48	5 x 11	54	5 x 11	57	5 x 11	63
47	5 x 11	45	5 x 11	57	5 x 11	66	5 x 11	69	6 x 11	84
100	5 x 11	78	5 x 11	87	6 x 11	105	6 x 11	111	8 x 11	138
220	6 x 11	129	6 x 11	138	8 x 11	180	8 x 11	192	10 x 12	222
330	6 x 11	159	8 x 11	198	8 x 11	216	10 x 12	252	10 x 15	294
470	8 x 11	216	8 x 11	234	10 x 12	282	10 x 15	324	10 x 19	384
1000	10 x 12	342	10 x 15	378	10 x 19	474	12 x 20	570	13 x 25	660
2200	13 x 20	630	13 x 20	660	13 x 25	810	16 x 25	730	16 x 32	708
3300	13 x 20	750	13 x 25	840	16 x 25	1020	16 x 32	1170	18 x 36 22 x 30	1330 1330
4700	16 x 25	1020	16 x 25	1080	16 x 32	260	18 x 36 22 x 30	1410 1410	18 x 40 22 x 35	1490 1470
6800	16 x 25	1140	16 x 32	1290	18 x 36 22 x 30	1500 1480	22 x 40	1550		
10000	16 x 32	1350	18 x 36 22 x 30	1500 1480	18 x 40 22 x 35	1580 1560				
12000	16 x 36	1470	18 x 36 22 x 30	1560 1530	22 x 40	1640				
15000	18 x 36 22 x 30	1508 1590	18 x 40 22 x 35	1632 1600						
18000	18 x 40 22 x 35	1650 1650	22 x 40	1710						
22000	22 x 40	1710								

Note : * 1. D x L : mm

* 2. mA rms at 105°C, 120Hz



CASE SIZE OF STANDARD PRODUCTS $D\phi \geq 6\text{mm}$ with Safety Vent at Can Bottom

CAP. (μF)	RATED VOLTAGE WV									
	50		63		100		160		200	
	Size	Ripple	Size	Ripple	Size	Ripple	Size	Ripple	Size	Ripple
0.1	5 x 11	1.1			5 x 11	1.1				
0.22	5 x 11	2.3			5 x 11	2.3				
0.33	5 x 11	3.5			5 x 11	3.5				
0.47	5 x 11	5			5 x 11	5	6 x 11	7.2	6 x 11	7.2
1	5 x 11	10			5 x 11	10	6 x 11	10.2	6 x 11	10.2
2.2	5 x 11	14			5 x 11	18	6 x 11	16	6 x 11	16
3.3	5 x 11	21			5 x 11	24	8 x 11	21	8 x 11	21
4.7	5 x 11	24	5 x 11	27	5 x 11	27	8 x 11	24	10 x 12	27
10	5 x 11	39	5 x 11	42	6 x 11	45	10 x 12	39	10 x 15	42
22	6 x 11	57	6 x 11	69	8 x 11	78	10 x 19	66	10 x 22	66
33	6 x 11	75	8 x 11	84	10 x 12	102	13 x 20	90	13 x 25	96
47	6 x 11	90	8 x 11	114	10 x 15	138	13 x 25	108	13 x 25	108
100	8 x 11	150	10 x 12	180	13 x 20	240	16 x 25	180	16 x 32	198
150							16 x 36	252	18 x 36	270
									22 x 30	270
220	10 x 15	264	10 x 19	294	16 x 25	436	18 x 36	306	18 x 40	312
							22 x 30	306	22 x 35	312
270							18 x 40	324	22 x 40	342
							22 x 35	324		
330	10 x 19	398	13 x 20	408	16 x 25	516	22 x 40	360		
470	13 x 20	456	13 x 25	528	16 x 32	660				
1000	16 x 25	810	18 x 32	930	18 x 40	1010				
					22 x 35	1010				
2200	18 x 36	1250	18 x 40	1320						
	22 x 30	1250	22 x 35	1350						
3300	22 x 40	1420								

Note: * 1. D x L : mm

* 2. mA rms at 105°C, 120Hz



CASE SIZE OF STANDARD PRODUCTS $D\phi \geq 6\text{mm}$ with Safety Vent at Can Bottom

CAP. (μF)	RATED VOLTAGE WV									
	250		315		350		400		450	
	Size	Ripple	Size	Ripple	Size	Ripple	Size	Ripple	Size	Ripple
0.47	6 x 11	7.2								
1	6 x 11	10.2	6 x 11	10.2	8 x 11	10.8	8 x 11	10.8	10 x 12	11.4
2.2	8 x 11	18	8 x 11	18	10 x 12	18	10 x 12	18	10 x 19	17.4
3.3	10 x 12	21	10 x 12	21	10 x 15	21	10 x 19	21	10 x 19	21
4.7	10 x 12	27	10 x 15	45	10 x 15	27	10 x 19	27	13 x 20	30
10	10 x 19	42	10 x 19	42	13 x 20	42	13 x 20	42	13 x 25	45
22	13 x 25	78	13 x 25	72	13 x 25	66	16 x 25	66	16 x 32	66
33	13 x 25	96	16 x 25	90	16 x 32	84	16 x 32	84	18 x 36	90
									22 x 30	84
47	16 x 25	126	16 x 30	144	18 x 36	132	18 x 36	132	22 x 40	138
					22 x 30	132	22 x 30	132		
100	18 x 36	204	18 x 40	204	22 x 40	216				
	22 x 30	204	22 x 35	204						
150	18 x 40	276	22 x 40	270						
	22 x 35	276								
220	22 x 40	320								

Note : * 1. D x L : mm

* 2. mA rms at 105°C, 120Hz

Miniature Size Aluminum Electrolytic Capacitors

SP [Miniature and Long Life]

105°C Single-Ended Lead Aluminum Electrolytic Capacitors For Electronic Ballast

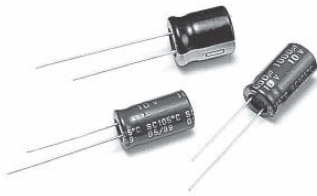

DESCRIPTION

Applicable for Electronic Ballast

High Temperature Load Life at 105°C for 8000~10000 Hours

Frequency coefficient

Frequency(Hz)	120	1K	10K	100K
Coefficient	0.50	0.80	0.90	1.00

Temperature coefficient

Temperature(°C)	65	85	105
Factor	1.70	1.40	1.00

DIAGRAM OF DIMENSIONS

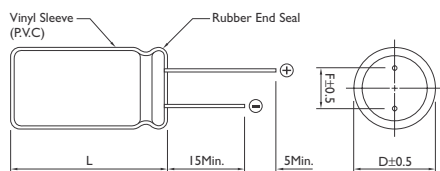

ELECTRICAL CHARACTERISTICS

Operating Temperature : -40° ~ +105°C -25° ~ +105°C

Working Voltage : 160 ~ 400V 450V

Rate Capacitance Range : 3.3 ~ 330μF

Capacitance Tolerance : -20 ~ +20%

DC Leakage Current (μA) : I = 0.04 + 100 CV(μA)

(Measurements shall be Made After a 2 Minute Charge at Rated Working Voltage)

Dissipation Factor : at 120 Hz, 25°C

WV (V) :	160	200	400	450
D.F (%) :	20	20	24	24

WV (V) :	160	200	400	450
Z - 25°C / Z + 20°C	3	3	5	6
Z - 40°C / Z + 20°C	6	6	6	

Load Life : 8000~10000 Hours at 105°C Assured with Full Rated Maximum Ripple Current Applied

- (a) Capacitance Change : Within 20% of Initial Value
- (b) Dissipation Factor : Not Exceed 200% of Initial Requirement
- (c) Leakage Current : Not Exceed the Initial Requirement

Shelf Life : 1000 Hours, No Voltage Applied, at 105°C

- (a) Capacitance Change : Within 20% of Initial Value
- (b) Dissipation Factor : Not Exceed 200 % of Initial Requirement
- (c) Leakage Current : Not Exceed 200% of Initial Requirement

Dimensions : mm

Rubber Stand-off

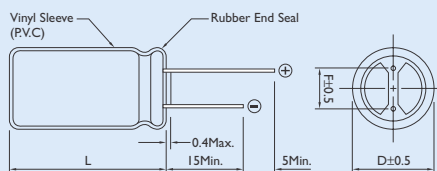

L ≤ 12 L + 1.5Max.
 13 ≤ L ≤ 15 L +1.0
 L -0.5
 L ≥ 16 L + 2.0Max.

Dø	F	dø
4.0	1.5	0.45
5.0	2.0	0.5
6.0	2.5	
8.0	3.5	
10.0	5.0	0.6
12.0		
13.0		
16.0	7.5	0.8
18.0		
22.0	10.0	0.8



CASE SIZE OF STANDARD PRODUCTS AND PERMISSIBLE RIPPLE CURRENT

CAP. (μ F)	RATED VOLTAGE WV					
	160			200		
	Size	Ripple	Impedance	Size	Ripple	Impedance
22				10 x 19	440	1.30
33	10 x 19	500	1.30	10 x 19	520	0.91
				13 x 20	580	0.91
47	10 x 19	580	0.96	13 x 20	660	0.91
	13 x 20	660	0.96			
68	12 x 25	720	0.64	13 x 25	720	0.63
	16 x 20	760	0.64	16 x 20	760	0.56
100	13 x 25	970	0.48	16 x 25	1120	0.27
	16 x 20	1120	0.56			
	16 x 25	1120	0.48			
	18 x 20	1120	0.56			
150	16 x 25	1200	0.40	16 x 32	1280	0.22
	16 x 32	1300	0.40			
	18 x 25	1300	0.40			
220	16 x 32	1300	0.27			
	18 x 25	1300	0.36			
330	18 x 36	1380	0.21			

Note : * 1. D x L : mm

* 2. mA rms at 105°C, 120Hz



CASE SIZE OF STANDARD PRODUCTS AND PERMISSIBLE RIPPLE CURRENT

CAP. (μ F)	RATED VOLTAGE WV					
	400			450		
	Size	Ripple	Impedance	Size	Ripple	Impedance
3.3				10 x 15	100	7.00
4.7				10 x 19	140	5.10
6.8	10 x 19	150	4.80	10 x 19	150	4.80
				13 x 20	180	4.20
10	10 x 19	180	2.90	13 x 20	310	2.50
22	16 x 20	300	0.95	16 x 25	560	1.70
				18 x 20	550	2.10
33	16 x 25	520	0.91	16 x 32	620	1.10
				18 x 25	590	1.10
47	16 x 32	700	0.68	16 x 36	880	0.93
				18 x 32	880	0.93
68	18 x 32	870	0.63			

Note : * 1. D x L : mm

* 2. mA rms at 105°C, 120Hz

Miniature Size Aluminum Electrolytic Capacitors

SB [For Low Leakage Current]

105°C Single-Ended Lead Aluminum Electrolytic Capacitors

ELECTRICAL CHARACTERISTICS

Operating Temperature : -40° ~ +105°C

Working Voltage : 6.3 ~ 100V

Rate Capacitance Range : 0.1 ~ 4700μF

Capacitance Tolerance : -20 ~ +20%

DC Leakage Current (μA) : I = 0.002CV (μA) or 0.4μA Whichever is greater.
(After 2 Minutes Application of DC Working Voltage at 25°C)

Equivalent Series Resistance (E.S.R, at 120Hz):

When measured at 25°C and 1 KHz E.S.R value shall not exceed the value given in the table on the next page.

WV (V) :	6.3	10	16	25	35 ~ 100
D.F (%) :	20	16	13	12	10

For capacitor whose capacitance exceeds 1000μF. The value of D.F(%) is increased by 2% for every addition of 1000μF.

Load Life : 1000 Hours at 105°C Assured with Full Rated Maximum Ripple Current Applied

- (a) Capacitance Change : Within 25% of Initial Value
- (b) Dissipation Factor : Not Exceed 200% of Initial Requirement
- (c) Leakage Current : Not Exceed the Initial Requirement

Shelf Life : 500 Hours, No Voltage Applied, at 105°C

- (a) Capacitance Change : Within 25% of Initial Value
- (b) Dissipation Factor : Not Exceed 200% of Initial Requirement
- (c) Leakage Current : Not Exceed 200% of Initial Requirement

WV (V) :	6.3	10	16	25	35 ~ 100
Impedance : Z - 40°C / Z + 20°C	4	4	3	3	3

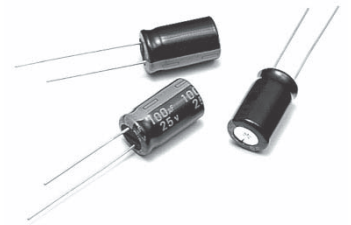

DESCRIPTION

Used in where low leakage current is essential as in coupling of pre-amplifies.

Very low leakage current remains even after prolonged storage.

Multiplier for Ripple Current

Frequency coefficient

Frequency(Hz)	50	120	300	1K	10K	100K
6.3~25V	0.85	1.00	1.04	1.08	1.19	1.19
26~50V	0.80	1.00	1.30	1.40	1.43	1.43
50~100V	0.77	1.00	1.34	1.43	1.48	1.48

Temperature coefficient

Temperature(°C)	65	85	105
Factor	1.50	1.20	1.00

DIAGRAM OF DIMENSIONS

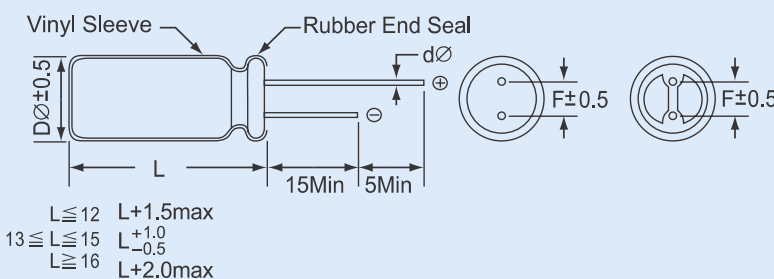

Dimensions : mm

Dø	F	dø
4.0	1.5	0.45
5.0	2.0	0.5
6.0	2.5	
8.0	3.5	
10.0	5.0	0.6
12.0		
13.0		
16.0	7.5	0.8
18.0		
22.0	10.0	0.8



CASE SIZE OF STANDARD PRODUCTS $D\phi \geq 6\text{mm}$ with Safety Vent at Can Bottom

CAP. (μF)	RATED VOLTAGE WV													
	SIZE	6.3				SIZE	10				SIZE	16		
	Ripple 120Hz	Impedance 10K Hz	ESR 120Hz 1K Hz			Ripple 120Hz	Impedance 10K Hz	ESR 120Hz 1K Hz			Ripple 120Hz	Impedance 10K Hz	ESR 120Hz 1K Hz	
0.1														
0.15														
0.22														
0.33														
0.47														
0.56														
0.68														
1.0														
1.5														
2.2														
3.3														
4.7														
6.8														
10											5x11	40	5.00	17.00 11.30
15											5x11	56	4.43	10.60 7.07
22						5x11	68	4.01	7.83	5.22	6x11	70	3.70	7.23 4.82
33						6x11	78	2.67	5.22	3.48	6x11	95	2.46	4.82 3.21
47						6x11	106	1.87	3.66	2.44	8x11	122	1.73	3.38 2.25
68	6x11	80	1.50	3.00	2.00	6x11	142	1.29	2.53	1.68	8x11	168	1.20	2.34 1.56
100	6x11	126	0.88	1.72	1.15	8x11	179	0.87	1.72	1.14	10x12	264	0.81	1.59 1.06
150	8x11	196	0.59	1.15	0.77	10x12	280	0.58	1.14	0.76	10x15	416	0.53	1.06 0.70
220	10x12	272	0.40	0.78	0.52	10x15	355	0.40	0.78	0.52	10x19	553	0.36	0.72 0.48
330	10x15	388	0.26	0.52	0.34	10x19	480	0.26	0.52	0.34	13x20	732	0.24	0.48 0.32
470	10x19	507	0.18	0.36	0.24	13x20	640	0.18	0.36	0.24	13x20	1040	0.16	0.33 0.22
680	13x20	700	0.12	0.25	0.16	13x25	848	0.12	0.25	0.16	13x25	1280	0.11	0.23 0.15
820	13x25	850	0.11	0.21	0.14	13x25	980	0.11	0.21	0.14	16x25	1450	0.09	0.18 0.12
1000	13x25	896	0.08	0.17	0.11	13x25	1081	0.08	0.17	0.11	16x25	1700	0.06	0.14 0.10
1500	13x25	1204	0.05	0.11	0.07	16x25	1376	0.05	0.11	0.07	16x32	1750	0.06	0.10 0.06
2200	16x25	1513	0.04	0.09	0.06	16x32	1680	0.04	0.09	0.06	18x36	1900	0.05	0.08 0.06
3300	16x36	1902	0.04	0.06	0.04	16x36	2155	0.03	0.06	0.04	18x40	2250	0.04	0.06 0.04
4700	18x36	2272	0.02	0.05	0.03	18x36	2560	0.02	0.05	0.03				

Note : * 1. D x L : mm

* 2. Ripple Current mA rms at 105°C, 100Hz

* 3. Impedance : (ohm) 25°C/10KHz

* 4. ESR : (ohm) 25°C/120Hz and 1KHz



CASE SIZE OF STANDARD PRODUCTS $D\phi \geq 6\text{mm}$ with Safety Vent at Can Bottom

CAP. (μF) RATED VOLTAGE WV

	25				35				50						
	SIZE	Ripple 120Hz	Impedance 10K Hz	ESR 120Hz 1K Hz	SIZE	Ripple 120Hz	Impedance 10K Hz	ESR 120Hz 1K Hz	SIZE	Ripple 120Hz	Impedance 10K Hz	ESR 120Hz 1K Hz			
0.1									5x11	1	323.00	510.0	215.0		
0.15									5x11	4	270.00	355.0	126.0		
0.22									5x11	4	235.00	223.0	80.00		
0.33									5x11	6	175.00	185.0	65.20		
0.47									5x11	7	90.00	96.00	45.70		
0.56									5x11	7	40.00	50.00	33.00		
0.68									5x11	9	38.50	47.00	31.20		
1.0									5x11	18	32.70	43.40	25.30		
1.5									5x11	24	28.50	35.20	21.70		
2.2									5x11	30	22.40	32.50	17.50		
3.3									5x11	36	17.40	24.30	13.20		
4.7	5x11	27	8.00	20.00	13.00	5x11	40	14.40	28.20	18.80	6x11	45	12.50	20.70	9.20
6.8	5x11	42	7.60	19.50	11.00	5x11	45	10.00	19.50	13.00	6x11	55	10.00	19.50	9.00
10	6x11	63	6.80	13.20	8.84	6x11	67	6.80	13.20	8.84	8x11	82	6.80	13.20	8.84
15	6x11	67	4.53	8.84	5.89	8x11	75	4.53	8.80	5.89	8x11	97	4.56	8.84	5.89
22	8x11	84	3.08	6.02	4.01	8x11	97	3.08	6.02	4.01	10x12	127	3.08	6.02	4.01
33	8x11	102	2.05	4.01	2.67	10x12	139	2.05	4.01	2.67	10x15	156	2.05	4.01	2.67
47	10x12	141	1.44	2.82	1.88	10x12	166	1.44	2.82	1.88	10x15	217	1.44	2.82	1.88
68	10x12	190	1.00	1.95	1.30	10x15	238	1.00	1.95	1.30	10x19	300	1.00	1.95	1.30
100	10x15	277	0.67	1.32	0.88	10x19	310	0.67	1.32	0.88	13x25	390	0.67	1.32	0.88
150	10x19	455	0.44	0.88	0.58	13x20	491	0.44	0.88	0.58	13x25	569	0.44	0.88	0.58
220	13x20	590	0.30	0.60	0.40	13x25	630	0.30	0.60	0.40	16x25	910	0.30	0.60	0.40
330	13x25	754	0.20	0.40	0.26	16x25	771	0.20	0.40	0.26	16x32	986	0.20	0.40	0.26
470	16x25	1110	0.13	0.28	0.18	16x25	1150	0.15	0.28	0.18	16x36	1249	0.13	0.28	0.18
680	16x32	1385	0.09	0.19	0.12	16x3	1462	0.09	0.19	0.12	16x36	1870	0.09	0.19	0.12
820	16x32	1540	0.08	0.15	0.10	16x36	1630	0.08	0.15	0.10	16x36	1950	0.08	0.15	0.10
1000	16x36	1710	0.06	0.13	0.08	18x36	1723	0.06	0.13	0.08	18x40	2070	0.06	0.13	0.08
1500	16x36	1779	0.03	0.08	0.05	18x4	2006	0.03	0.08	0.05					
2200	18x40	2174	0.03	0.06	0.04										
3300															
4700															

Note : * 1. D x L : mm

* 2. Ripple Current mA rms at 105°C, 100Hz

* 3. Impedance : (ohm) 25°C/10KHz

* 4. ESR : (ohm) 25°C/120Hz and 1KHz

Miniature Size Aluminum Electrolytic Capacitors

SR [For Horizontal Deflection]

Bi-Polarized Capacitors for Horizontal Deflection Circuits of TV Sets



DESCRIPTION

Non-Polar Type for Used in Horizontal Deflection Current

Correction at High Frequency and High Ripple Currents

Frequency coefficient

Frequency(Hz)	60	120	400~1K	15.75K
Coefficient	0.40	0.40	0.80	1.00

Temperature coefficient

Temperature(°C)	65	70	85
Factor	1.15	1.00	0.80

DIAGRAM OF DIMENSIONS

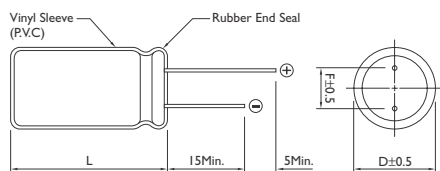

ELECTRICAL CHARACTERISTICS

Operating Temperature : -40° ~ +85°C

Working Voltage : 25, 35, 50V

Rate Capacitance Range : 2.2 ~ 47μF

Capacitance Tolerance : -20 ~ +20%

DC Leakage Current (μA) : 100μA Max.

(After 5 Minutes in Both Direction, at 25°C)

Dissipation Factor : at 120 Hz, 25°C

WV (V) :	25	35	50
D.F (%) :	5	5	5

Load Life : 1000 Hours at 70°C with Permissible Ripple Current at 15.75 KHz

(Polarity Inverted Every 250 Hours)

- (a) Capacitance Change : Within 20% of Initial Value
- (b) Dissipation Factor : Not Exceed 200% of Initial Requirement
- (c) Leakage Current : Not Exceed the Initial Requirement

Shelf Life : 500 Hours, No Voltage Applied, at 85°C

- (a) Capacitance Change : Within 20% of Initial Value
- (b) Dissipation Factor : Not Exceed 200% of Initial Requirement
- (c) Leakage Current : Not Exceed 200% of Initial Requirement

Rubber Stand-off

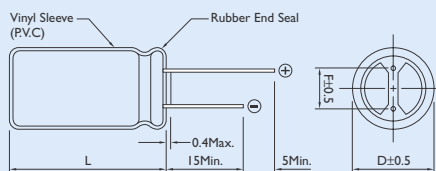

L ≤ 12 L + 1.5Max.
 13 ≤ L ≤ 15 L +1.0 / -0.5
 L ≥ 16 L + 2.0Max.

Dimensions : mm

Dø	F	dø
4.0	1.5	0.45
5.0	2.0	0.5
6.0	2.5	
8.0	3.5	
10.0	5.0	0.6
12.0		
13.0		
16.0	7.5	0.8
18.0		
22.0	10.0	0.8



CASE SIZE & PERMISSIBLE RIPPLE CURRENT OF STANDARD PRODUCTS

CAP. (μF)	RATED VOLTAGE WV					
	25		35		50	
	Size	Ripple	Size	Ripple	Size	Ripple
2.2	16 × 25	6	16 × 25	6	16 × 25	6
3.3	16 × 25	7	16 × 25	7	16 × 25	7
4.7	16 × 25	7	16 × 25	7	16 × 25	7
5.6	16 × 32	7	16 × 32	7	16 × 32	7
6.8	16 × 36	8	16 × 36	8	16 × 36	8
8.2	16 × 36	8	16 × 36	8	16 × 36	8
10	18 × 40	12	18 × 40	12	18 × 40	12
13	18 × 40	12	18 × 40	12	18 × 40	12
15	18 × 40	12	18 × 40	12	18 × 40	12
18	22 × 40	13	22 × 40	13	22 × 40	13
20	22 × 40	13	22 × 40	13	22 × 40	13
22	22 × 40	13	22 × 40	13	22 × 40	13
25	22 × 40	13	22 × 40	13	22 × 40	13
47	22 × 40	13	22 × 40	13		

Note : * 1. D × L : mm

* 2. mA rms at 105°C, 120Hz

Miniature Size Aluminum Electrolytic Capacitors

SN [For Non Polar]

105°C Single-Ended Lead Aluminum Electrolytic Capacitors For Non-Polar General Purpose



DESCRIPTION

Non-polar miniature type for used in reversing polarity DC voltage circuits.

Frequency coefficient

Frequency(Hz)	60	120	300	1K	10K~100K
Factor	0.75	1.00	1.20	1.32	1.65

Temperature coefficient

Temperature(°C)	65	85	105
Factor	1.30	1.20	1.00

DIAGRAM OF DIMENSIONS

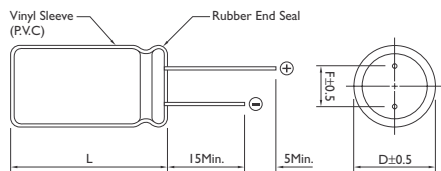

ELECTRICAL CHARACTERISTICS

Operating Temperature : -40°C ~ +105°C

Working Voltage : 6.3 ~ 100V

Rate Capacitance Range : 0.47 ~ 2200μF

Capacitance Tolerance : -20 ~ +20%

DC Leakage Current (μA) : $I = 0.03 CV + 3\mu A$

(After 5 Minutes Application of DC Working Voltage at 25°C)

Dissipation Factor : at 120Hz, 25°C

WV (V)	6.3	10	16	25	35	50	100
D.F (%)	24	20	17	15	14	12	10

For capacitor whose capacitance exceeds 1000μF. The value of D.F.(%) is increased by 2% for every addition of 1000μF.

Load Life : 1000 Hours at 105°C with the Polarity Inverted Every 250 Hours

- (a) Capacitance Change : Within 25% of Initial Value
- (b) Dissipation Factor : Not Exceed 150% of Initial Requirement
- (c) Leakage Current : Not Exceed the Initial Requirement

Shelf Life : 500 Hours, No Voltage Applied, at 105°C

- (a) Capacitance Change : Within 25% of Initial Value
- (b) Dissipation Factor : Not Exceed 200% of Initial Requirement
- (c) Leakage Current : Not Exceed 200% of Initial Requirement

Dimensions : mm

Rubber Stand-off

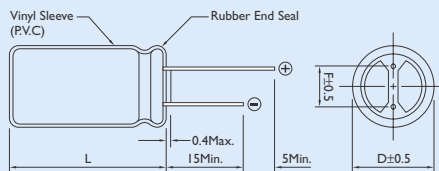

$L \leq 12$ $L + 1.5\text{Max.}$
 $13 \leq L \leq 15$ $L^{+1.0}_{-0.5}$
 $L \geq 16$ $L + 2.0\text{Max.}$

Dø	F	dø
4.0	1.5	0.45
5.0	2.0	0.5
6.0	2.5	
8.0	3.5	
10.0	5.0	0.6
12.0		
13.0		
16.0	7.5	0.8
18.0		
22.0	10.0	0.8



CASE SIZE & PERMISSIBLE RIPPLE CURRENT OF STANDARD PRODUCTS

CAP. (μF)	RATED VOLTAGE WV																	
	6.3		10		16		25		35		50		63		80		100	
	Size	Ripple	Size	Ripple	Size	Ripple	Size	Ripple	Size	Ripple	Size	Ripple	Size	Ripple	Size	Ripple	Size	Ripple
0.22											5x11	5						
0.47											5x11	5	5x11	11	5x11	11	5x11	14
1											5x11	17	5x11	17	5x11	17	5x11	21
2.2											5x11	25	5x11	25	5x11	29	6x11	34
3.3											6x11	31	6x11	37	6x11	39	8x11	49
4.7									5x11	34	5x11	34	5x11	37	8x11	47	8x11	58
											6x11	41	6x11	44				
10					6x11	45	5x11	42	6x11	54	6x11	56	8x11	74	10x12	88	8x11	80
							6x11	50			8x11	70					10x12	100
			5x11	57	5x11	59	6x11	69	8x11	94	6x11	75	8x11	95	10x19	150	13x20	180
22					6x11	69	8x11	86			8x11	97	10x15	130				
											10x12	115						
33	5x11	63	6x11	77	8x11	98	8x11	105	10x12	125	8x11	110	8x11	115	13x20	205	13x20	220
											10x15	150	10x19	175				
47	6x11	84	6x11	93	8x11	115	10x12	140	10x15	165	8x11	130	13x20	230	13x20	245	13x25	285
											10x19	190						
100	8x11	140	8x11	193	8x11	140	10x19	240	13x20	285	13x20	310	16x25	410	16x25	435	16x32	510
					10x12	175												
					10x15	205												
220	10x12	235	10x15	255	10x19	330	13x20	390	16x25	520	16x25	570	16x32	660				
330	10x15	310	10x19	380	13x20	445	16x25	580	16x25	630	16x36	790						
470	10x19	400	13x20	470	13x25	570	16x25	690	16x32	820								
1000	13x25	690	16x25	885	16x32	1020												
2200	16x32	1250	16x36	1450														

Note : * 1. D × L : mm

* 2. Ripple Current mA rms at 105°C, 120KHz

Miniature Size Aluminum Electrolytic Capacitors

SC [For Low Impedance and Low E.S.R
Suitable for Output of Mother Board]

105°C Single-Ended Lead Aluminum Electrolytic Capacitors For High Frequency Applications

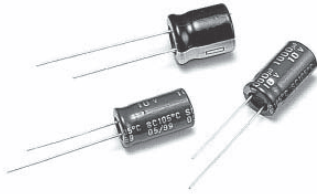

DESCRIPTION

Used in switching regulator applications in computers. Especially for high frequency.

Low impedance and E.S.R., high permissible ripple current at high frequency and higher operating temperature (-40°C to +105°C).

High Temperature Load Life at 105°C for 3000 Hours

Multiplier for Ripple Current

Frequency coefficient

Frequency(Hz)	50	120	300	1K	10K	100K
~4.7μF	0.30	0.40	0.50	0.70	0.80	1.00
5.6~33μF	0.40	0.50	0.60	0.80	0.90	1.00
34~330μF	0.60	0.70	0.80	0.90	0.95	1.00
331~1000μF	0.65	0.95	0.90	0.98	1.00	1.00
1200μF Higher	0.85	0.90	0.95	0.98	1.00	1.00

Temperature coefficient

Temperature(°C)	65	85	105
Factor	1.80	1.50	1.00

DIAGRAM OF DIMENSIONS

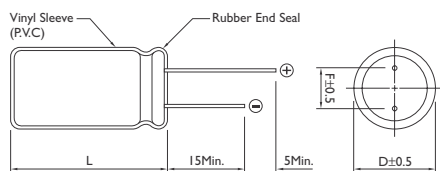

ELECTRICAL CHARACTERISTICS

Operating Temperature : -40° ~ +105°C

Working Voltage : 6.3 ~ 100V

Rate Capacitance Range : 4.7 ~ 15000μF

Capacitance Tolerance : -20 ~ +20%

DC Leakage Current (μA) : I = 0.01 CV(μA) or 3μA Whichever is greater.

(Measurements shall be Made After a 2 Minute Charge at Rated Working Voltage)

Dissipation Factor : at 120 Hz, 25°C

WV (V) : $\frac{6.3}{15}$ $\frac{10}{14}$ $\frac{16}{12}$ $\frac{25}{10}$ $\frac{35}{10}$ $\frac{50}{8}$ $\frac{63}{8}$ $\frac{80}{7}$ $\frac{100}{7}$ --

For capacitor whose capacitance exceeds 1000μF. The value of D.F(%) is increased by 2% for every addition of 1000μF.

WV (V) : $\frac{6.3}{10}$ $\frac{10}{8}$ $\frac{16}{5}$ $\frac{25}{4}$ $\frac{35}{4}$ $\frac{50}{4}$ $\frac{63}{4}$ $\frac{100}{4}$ --

Load Life : 3000 Hours at 105°C Assured with Full Rated Maximum Ripple Current Applied

5 x 11 ~ 10 x 12 : Life = 2000 Hours

10 x 15 or Higher : Life = 3000 Hours

(a) Capacitance Change : Within 20% of Initial Value

(b) Dissipation Factor : Not Exceed 200% of Initial Requirement

(c) Leakage Current : Not Exceed the Initial Requirement

Shelf Life : 1000 Hours, No Voltage Applied, at 105°C

(a) Capacitance Change : Within 20% of Initial Value

(b) Dissipation Factor : Not Exceed 200 % of Initial Requirement

(c) Leakage Current : Not Exceed 200% of Initial Requirement

Dimensions : mm

Rubber Stand-off

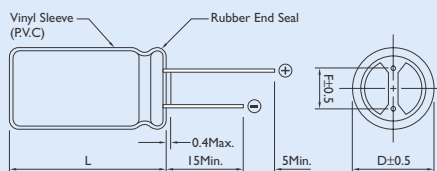

L ≤ 12 L + 1.5Max.
13 ≤ L ≤ 15 L +1.0
L -0.5
L ≥ 16 L + 2.0Max.

Dø	F	dø
4.0	1.5	0.45
5.0	2.0	0.5
6.0	2.5	
8.0	3.5	
10.0	5.0	0.6
12.0		
13.0		
16.0	7.5	0.8
18.0		
22.0	10.0	0.8



CASE SIZE OF STANDARD PRODUCTS $D\phi \geq 6\text{mm}$ with Safety Vent at Can Bottom

CAP. (μF)	RATED VOLTAGE WV											
	Size	6.3 Ripple	ESR	Size	10 Ripple	ESR	Size	16 Ripple	ESR	Size	25 Ripple	ESR
4.7												
6.8												
10										*4 x 7	40	2.000
										5 x 11	50	0.550
22												
33												
47										5 x 11	150	0.420
56												
68							5 x 11	150	0.420	6 x 11	200	0.370
100				5 x 11	150	0.420	5 x 11	200	0.370	6 x 11	250	0.220
120				5 x 11	200	0.370	6 x 11	250	0.320	8 x 11	300	0.200
150	5 x 11	200	0.420	6 x 11	250	0.320	6 x 11	300	0.220	8 x 11	550	0.140
220	6 x 11	250	0.320	6 x 11	300	0.220	8 x 11	550	0.140	*8 x 11	620	0.120
										8 x 15	750	0.100
270	*6 x 11	300	0.220									
	*6 x 11	320	0.230	8 x 11	550	0.140	*8 x 11	620	0.120	*8 x 15	660	0.100
330	8 x 11	400	0.180				8 x 15	750	0.100	8 x 20	800	0.069
										10 x 15	900	0.086
	*6 x 11	440	0.160	*8 x 11	620	0.120	*8 x 15	730	0.093	*8 x 20	1000	0.067
470	8 x 11	550	0.140	8 x 15	750	0.100	10 x 12	800	0.085	*10 x 12	900	0.086
										10 x 15	1050	0.064
680	*8 x 11	580	0.120	*8 x 11	640	0.110	10 x 15	1050	0.064	10 x 19	1100	0.039
	8 x 15	700	0.100	10 x 12	800	0.085						
820	8 x 20	750	0.085	10 x 15	1050	0.064	10 x 19	1100	0.044	10 x 19	1250	0.039
	*8 x 11	580	0.150	8 x 20	1080	0.065	*10 x 15	1140	0.043	*10 x 19	1160	0.047
1000	*8 x 15	670	0.069	10 x 12	930	0.075	10 x 19	1250	0.039	*10 x 25	1310	0.042
	8 x 20	800	0.069	10 x 15	990	0.085				13 x 20	1450	0.038
	10 x 12	690	0.080	10 x 19	1100	0.050						
1200	10 x 15	1000	0.064	10 x 19	1250	0.044	*10 x 25	1310	0.042			
							13 x 20	1450	0.038			
	*8 x 15	980	0.085	10 x 9	1450	0.039	*10 x 19	1200	0.045	*12 x 30	1750	0.032
1500	*8 x 20	1070	0.051				13 x 20	1600	0.034	16 x 25	2000	0.028
	*10 x 15	1070	0.055									
	10 x 19	1250	0.044									
	*10 x 19	1220	0.051	*10 x 19	1330	0.047	*10 x 30	1780	0.032	*13 x 30	1810	0.029
2200	*10 x 25	1310	0.048	*10 x 25	1450	0.025	*13 x 20	1720	0.033	*16 x 25	1660	0.032
	13 x 20	1450	0.043	13 x 20	1600	0.038	13 x 25	2000	0.028	16 x 32	2200	0.024
	*10 x 25	1400	0.043	*10 x 30	1740	0.032	*13 x 40	2200	0.026	16 x 36	2550	0.019
3300	13 x 25	1700	0.035	13 x 25	2000	0.028	16 x 25	2200	0.024			
3900	13 x 25	1750	0.032									
	*12 x 30	1570	0.033	*13 x 25	1860	0.028	16 x 6	2550	0.019	18 x 36	2800	0.019
4700	*13 x 25	1570	0.032	16 x 25	2200	0.024						
	16 x 25	1800	0.028									
6800	16 x 32	2000	0.024	16 x 36	2550	0.019	18 x 36	2800	0.019	18 x 36	2800	0.019
8200	16 x 32	2350	0.019	18 x 36	2800	0.019						
10000	16 x 36	2550	0.019									
15000	18 x 36	3000	0.019									

Note : * 1. D x L : mm

*2. Ripple Current :(mA r.m.s 105°C / 100KHz), ESR (Ω Max20°C/100KHz)

3. "" is down size, Edurance is less 1000 hrs than standard



CASE SIZE OF STANDARD PRODUCTS $D\phi \geq 6\text{mm}$ with Safety Vent at Can Bottom

CAP. (μF)	RATED VOLTAGE WV											
	Size	35 Ripple	ESR	Size	50 Ripple	ESR	Size	63 Ripple	ESR	Size	100 Ripple	ESR
4.7	5 x 11	115	1.200	5 x 11	115	2.000	5 x 11	115	2.200	5 x 11	120	2.000
6.8	5 x 11	120	1.000	5 x 11	120	1.850	5 x 11	200	2.000	5 x 11	140	1.850
10	5 x 11	140	0.900	5 x 11	140	1.700	5 x 11	140	1.850	6 x 11	200	1.500
15	5 x 11	170	0.690	5 x 11	180	1.200	5 x 11	200	1.700	6 x 11	250	1.200
22	5 x 11	190	0.420	5 x 11	200	0.700	6 x 11	250	1.200	8 x 11	300	0.790
33	5 x 11	200	0.420	6 x 11	250	0.600	6 x 11	300	0.900	8 x 15	450	0.590
47	6 x 11	250	0.370	6 x 11	300	0.520	8 x 11	450	0.700	10 x 15	550	0.350
68	6 x 11	300	0.220	8 x 11	450	0.350	8 x 11	550	0.520	10 x 9	650	0.240
100	*6 x 11	360	0.180	*8 x 11	480	0.290	8 x 20	650	0.350	13 x 20	800	0.180
	8 x 11	450	0.140	8 x 15	550	0.250						
120	8 x 11	550	0.130	8 x 20	650	0.210	10 x 15	800	0.300	13 x 25	1050	0.150
150	8 x 15	650	0.100	10 x 12	800	0.160	10 x 15	1050	0.200	13 x 5	1300	0.110
220	*8 x 15	730	0.075	10 x 15	1050	0.100	10 x 19	1300	0.150	16 x 25	1400	0.071
	10 x 12	800	0.069									
330	*10 x 15	900	0.052	10 x 9	1300	0.072	13 x 0	1400	0.100	16 x 2	1550	0.049
	10 x 19	1050	0.044									
470	10 x 19	1300	0.039	*10 x 19	1390	0.075	13 x 25	1550	0.064	18 x 36	1700	0.038
				13 x 20	1400	0.060						
680	13 x 20	1400	0.038	13 x 25	1550	0.050	16 x 25	1700	0.052			
820	13 x 20	1550	0.034	16 x 25	1700	0.040	16 x 32	1900	0.048			
1000	13 x 25	1700	0.029	16 x 25	1900	0.039	16 x 32	2100	0.042			
1200	16 x 25	1900	0.028	16 x 32	2100	0.025	16 x 36	2550	0.036			
1500	16 x 25	2100	0.024	16 x 36	2550	0.025	18 x 36	2800	0.033			
2200	*16 x 32	2300	0.021	18 x 40	2800	0.025						
	16 x 36	2550	0.019									
3300	18 x 36	2880	0.019									
3900												
4700												
6800												
8200												
10000												
15000												

Note : * 1. D x L : mm

*2. Ripple Current :(mA r.m.s 105°C / 100KHz), ESR (Ω Max20°C / 100KHz)

3. "" is down size, Edurance is less 1000 hrs than standard

Miniature Size Aluminum Electrolytic Capacitors

SM [For Very Low Impedance and Very Low E.S.R Suitable for Output of Mother Board]

105°C Single-Ended Lead Aluminum Electrolytic Capacitors For High Frequency Applications

ELECTRICAL CHARACTERISTICS

Operating Temperature : -40° ~ +105°C

Working Voltage : 6.3 ~ 25V

Rate Capacitance Range : 470 ~ 4700μF

Capacitance Tolerance : -20 ~ +20%

DC Leakage Current (μA) : I = 0.01 CV(μA)

(Measurements shall be Made After a 2 Minute Charge at Rated Working Voltage)

Dissipation Factor : at 120 Hz, 25°C

WV (V) : $\frac{6.3}{15}$ - $\frac{10}{14}$ - $\frac{16}{12}$ -

For capacitor whose capacitance exceeds 1000μF. The value of D.F(%) is increased by 2% for every addition of 1000μF.

Load Life : 2000 Hours for D = 8ø; 3000 Hours for D ≥ 10ø at 105°C

- (a) Capacitance Change : Within 20% of Initial Value
- (b) Dissipation Factor : Not Exceed 200% of Initial Requirement
- (c) Leakage Current : Not Exceed the Initial Requirement

Shelf Life : 1000 Hours, No Voltage Applied, at 105°C

- (a) Capacitance Change : Within 20% of Initial Value
- (b) Dissipation Factor : Not Exceed 200 % of Initial Requirement
- (c) Leakage Current : Not Exceed 200% of Initial Requirement

DIAGRAM OF DIMENSIONS

Dø	F	dø
4.0	1.5	0.45
5.0	2.0	0.5
6.0	2.5	
8.0	3.5	
10.0	5.0	0.6
12.0		
13.0		
16.0	7.5	0.8
18.0		
22.0	10.0	0.8

Rubber Stand-off

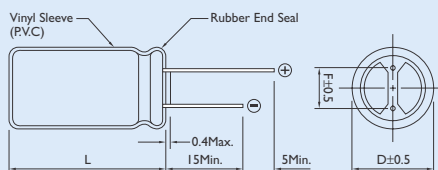

L ≤ 12 L + 1.5Max.
 13 ≤ L ≤ 15 L +1.0
 L -0.5
 L ≥ 16 L + 2.0Max.

DESCRIPTION



Used in switching regulator applications in computers. Especially for high frequency.

Very low impedance and E.S.R., high permissible ripple current at high frequency and higher operating temperature (-40°C to +105°C).

High Temperature Load Life at 105°C for 3000 Hours

Multiplier for Ripple Current

Frequency coefficient

Frequency(Hz)	60	120	1K	10K	100K
5.6~33μF	0.45	0.55	0.75	0.90	1.00
39~330μF	0.6	0.70	0.85	0.95	1.00
470~1000μF	0.65	0.75	0.90	0.98	1.00
1200~6800μF	0.75	0.80	0.95	1.00	1.00

Temperature coefficient

Temperature(°C)	65	85	105
Factor	2.00	1.60	1.00

Dimensions : mm

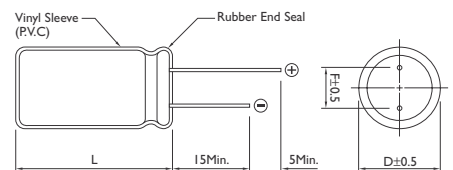



CASE SIZE OF STANDARD PRODUCTS $D\phi \geq 6\text{mm}$ with Safety Vent at Can Bottom

CAP. (μF)	RATED VOLTAGE								
	SIZE	6.3 Ripple	ESR	SIZE	10 Ripple	ESR	SIZE	16 Ripple	ESR
330							*8 x 11		0.066
470	8 x 11	582	0.100	8 x 11	760	0.072	8 x 15	995	0.056
							10 x 12	1030	0.053
680				8 x 11	760	0.056	8 x 20	1250	0.041
				8 x 15	995	0.067	10 x 15	1430	0.038
1000	8 x 15	950	0.053	8 x 20	1250	0.041	10 x 19	1820	0.023
				10 x 15	1430	0.038			
	8 x 20	1250	0.041	10 x 19	1820	0.023	*10 x 19	1900	0.023
1200	10 x 12	1240	0.044				10 x 22	2150	0.022
	10 x 15	1430	0.038						
1500	10 x 19	1820	0.023	*10 x 22	1920	0.025	13 x 20	2360	0.028
				10 x 25	2150	0.022			
2200	10 x 22	2150	0.023	13 x 20	2360	0.021	13 x 25	2770	0.025
2700	10 x 25	2200	0.022				13 x 30	3290	0.023
3300	*10 x 25	2200	0.024	13 x 25	2770	0.018			
	13 x 20	2360	0.021						
3900				13 x 30	3290	0.016			
4700	13 x 30	3290	0.016						

Note : * I. D x L : mm

*2. Ripple Current :(mA r.m.s 105°C / 100KHz), ESR (Ω Max20°C / 100KHz)

3. "" is down size, Edurance is less 1000 hrs than standard



CASE SIZE OF STANDARD PRODUCTS $D\phi \geq 6\text{mm}$ with Safety Vent at Can Bottom

CAP. (μF) RATED VOLTAGE

	25			35		
	SIZE	Ripple	ESR	SIZE	Ripple	ESR
220	8 x 11	760	0.072	8 x 15	995	0.056
				10 x 12	1030	0.053
270	*8 x 15		0.057	8 x 20	1250	0.041
330	10 x 12	1030	0.053	10 x 15	1430	0.038
470	8 x 20	1250	0.041	10 x 19	1820	0.023
	10 x 15	1430	0.038			
680	10 x 19	1820	0.028	13 x 20	2360	0.021
820	10 x 22	2150	0.024			
	10 x 25	2200	0.021			
	*10 x 30	2200	0.024	13 x 25	2770	0.025
1000	12 x 20	2360	0.025			
	13 x 25		0.021			
1200				13 x 30	3290	0.016
1500	13 x 30	2700	0.029			
2200						
2700						
3300						
3900						
4700						

Note : * 1. D x L : mm

*2. Ripple Current :(mA r.m.s 105°C / 100KHz), ESR (Ω Max20°C / 100KHz)

3. "" is down size, Edurance is less 1000 hrs than standard

SX [For Low Impedance & Low E.S.R]

105°C Single-Ended Lead Aluminum Electrolytic Capacitors For High Frequency Applications

Miniature Size Aluminum Electrolytic Capacitors

ELECTRICAL CHARACTERISTICS

Operating Temperature : -40° ~ +105°C

Working Voltage : 6.3 ~ 100V

Rate Capacitance Range : 22 ~ 15000μF

Capacitance Tolerance : -20 ~ +20%

DC Leakage Current (μA) : I = 0.01 CV or 3(μA) Whichever is greater.

(Measurements shall be Made After a 2 Minute Charge at Rated Working Voltage)

Dissipation Factor : at 120 Hz, 25°C

WV (V) :	6.3	10	16	25	35	50	63	80	100
D.F (%) :	19	16	14	12	10	8	8	7	7

For capacitor whose capacitance exceeds 1000μF. The value of D.F(%) is increased by 2% for every addition of 1000μF.

Temperature Characteristics : at 120 Hz

WV (V) :	6.3	10	16	25	35	50	63	100
Impedance : Z -40°C / Z +20°C	10	6	5	4	4	4	4	4

Load Life : At 105°C Assured with Full Rated Maximum Ripple Current Applied

Case Dia	øD ≤ 8	øD = 10	øD ≥ 12
----------	--------	---------	---------

Load Life	2000	3000	5000
-----------	------	------	------

- (a) Capacitance Change : Within 20% of Initial Value
- (b) Dissipation Factor : Not Exceed 200% of Initial Requirement
- (c) Leakage Current : Not Exceed the Initial Requirement

Shelf Life : 1000 Hours, No Voltage Applied, at 105°C

- (a) Capacitance Change : Within 20% of Initial Value
- (b) Dissipation Factor : Not Exceed 200 % of Initial Requirement
- (c) Leakage Current : Not Exceed 200% of Initial Requirement

DIAGRAM OF DIMENSIONS

Dø	F	dø
4.0	1.5	0.45
5.0	2.0	0.5
6.0	2.5	
8.0	3.5	
10.0	5.0	0.6
12.0		
13.0		
16.0	7.5	0.8
18.0		
22.0	10.0	0.8

Rubber Stand-off

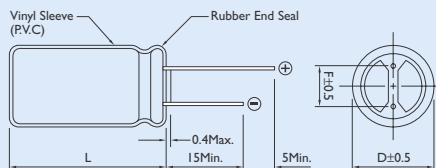

L ≤ 12 L + 1.5Max.
 13 ≤ L ≤ 15 L + 1.0Max.
 L ≥ 16 L + 2.0Max.

DESCRIPTION

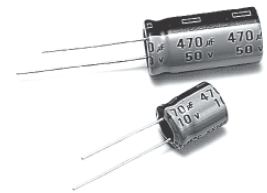

Used in switching regulator applications in computers. Especially for high frequency.

Low impedance and E.S.R., high permissible ripple current at high frequency and higher operation temperature (-40°C to +105°C).

High Temperature Load Life at 105°C for 2000 ~ 5000 Hours

Multiplier for Ripple Current

Frequency coefficient

Frequency(Hz)	50	120	300	1K	10K	100K
~4.4μF	0.30	0.40	0.50	0.70	0.80	1.00
5.6~33μF	0.40	0.50	0.60	0.80	0.90	1.00
34~330μF	0.60	0.70	0.80	0.90	0.95	1.00
331~1000μF	0.65	0.90	0.90	0.98	1.00	1.00
1200μF higher	0.85	0.90	0.95	0.98	1.00	1.00

Temperature coefficient

Temperature(°C)	65	85	105
Factor	1.80	1.50	1.00

Dimensions : mm



CASE SIZE OF STANDARD PRODUCTS $D\varnothing \geq 6\text{mm}$ with Safety Vent at Can Bottom

CAP. (μF)	RATED VOLTAGE								
	SIZE	6.3 Ripple	ESR	SIZE	10 Ripple	ESR	SIZE	16 Ripple	ESR
4.7									
6.8									
10				5 x 11	20	5.900			
							5 x 11	42	1.180
22				5 x 11	44	5.400	5 x 11	53	3.300
33				5 x 11	66	3.300	5 x 11	79	2.100
47				5 x 11	94	2.200	5 x 11	113	1.300
68				5 x 11	136	1.300	5 x 11	145	0.920
							6 x 11	163	0.920
100	5 x 11	166	1.500	5 x 11	170	1.150	6 x 11	190	1.100
				6 x 11	200	1.150	8 x 11	241	0.890
120	5 x 11	175	1.300	6 x 11	240	0.910	8 x 11	290	0.580
150	6 x 11	225	0.920	6 x 11	265	0.700	8 x 11	380	0.470
220	8 x 11	285	0.610	6 x 11	290	0.590	8 x 11	410	0.330
				8 x 11	370	0.480			
330	8 x 11	410	0.400	8 x 11	470	0.330	10 x 12	600	0.230
470	10 x 12	550	0.280	8 x 11	480	0.300	8 x 20	710	0.180
				10 x 12	590	0.240	10 x 15	750	0.180
680	10 x 15	735	0.220	8 x 20	790	0.180	10 x 19	1050	0.140
				10 x 15	750	0.170			
820	10 x 15	795	0.190	10 x 19	990	0.140	10 x 25	1220	0.120
1000	10 x 19	950	0.170	10 x 15	900	0.135	10 x 30	1400	0.091
				10 x 19	1060	0.120			
1200	10 x 19	1020	0.140	10 x 25	1290	0.120	10 x 25	1240	0.100
							12 x 25	1450	0.086
1500	10 x 19	1000	0.140	10 x 30	1450	0.093	12 x 25	1650	0.072
	10 x 25	1200	0.120						
2200	10 x 30	1450	0.095	12 x 30	1570	0.087	12 x 30	1820	0.069
				13 x 20	1900	0.073	13 x 25	2000	0.063
3300	12 x 35	1700	0.081	10 x 30	1690	0.077	13 x 40	2400	0.055
				12 x 35	2110	0.062			
4700	12 x 35	2110	0.063	13 x 40	2300	0.057	16 x 6	2650	0.046
				16 x 32	2450	0.054			
6800	16 x 32	2350	0.055	16 x 36	2680	0.046	18 x 36	2900	0.040
8200	16 x 36	2550	0.047	16 x 40	2850	0.038	18 x 40	3050	0.036
10000	16 x 40	2750	0.039	16 x 40	3050	0.037			
15000	18 x 40	2950	0.037						

Note : * 1. D x L : mm

*2. Ripple Current : (mA r.m.s 105°C / 100kHz)

*3. ESR (Ω Max20°C / 100kHz)



CASE SIZE OF STANDARD PRODUCTS $D\varnothing \geq 6\text{mm}$ with Safety Vent at Can Bottom

CAP. (μF)	RATED VOLTAGE								
	SIZE	25 Ripple	ESR	SIZE	35 Ripple	ESR	SIZE	50 Ripple	ESR
4.7									
6.8							5 × 11	39	3.100
10				5 × 11	42	3.100	5 × 1	58	2.000
22	5 × 11	66	3.300	5 × 11	101	1.300	6 × 11	129	0.900
33	5 × 11	99	1.300	6 × 11	151	0.870	8 × 11	194	0.720
47	5 × 1	141	1.100	8 × 11	216	0.870	8 × 11	276	0.660
68	8 × 11	204	0.570	8 × 11	312	0.370	10 × 12	400	0.310
100	6 × 11	240	0.530	8 × 11	370	0.390	8 × 15	530	0.240
	8 × 11	300	0.420	10 × 12	460	0.320	10 × 15	635	0.200
120	8 × 11	400	0.380	10 × 12	550	0.260	10 × 15	670	0.170
150	10 × 12	460	0.330	10 × 12	600	0.230	10 × 19	860	0.150
220	10 × 15	630	0.230	10 × 12	690	0.210	10 × 15	780	0.150
				10 × 15	800	0.180	10 × 25	1030	0.110
330	10 × 12	690	0.220	10 × 19	1060	0.130	10 × 30	1070	0.110
							10 × 15	800	0.190
470	10 × 15	890	0.165	10 × 30	990	0.089	12 × 25	1500	0.068
560	10 × 19	1170	0.120	12 × 20	1500	0.080			
							12 × 16	1200	0.120
680	10 × 30	1400	0.090	12 × 25	1650	0.070	12 × 35	1850	0.058
820	12 × 25	1450	0.085	12 × 30	1750	0.066	12 × 40	2020	0.052
1000	12 × 20	1420	0.091	12 × 30	2000	0.061	16 × 25	1800	0.060
							12 × 25	1650	0.078
1200	12 × 30	1700	0.070	12 × 35	2200	0.049	16 × 36	2260	0.043
1500	12 × 30	1950	0.062	12 × 40	2350	0.046	16 × 40	2420	0.035
2200	12 × 40	2360	0.054	16 × 36	2700	0.044			
3300	16 × 36	2700	0.045	18 × 40	3050	0.035			
3900									
4700	18 × 40	3000	0.036						
6800									
8200									
10000									
15000									

Note : * 1. D × L : mm

*2. Ripple Current : (mA r.m.s 105°C / 100KHz)

*3. ESR (Ω Max20°C / 100KHz)



CASE SIZE OF STANDARD PRODUCTS $D\varnothing \geq 6\text{mm}$ with Safety Vent at Can Bottom

CAP. (μF)	RATED VOLTAGE								
	SIZE	63 Ripple	ESR	SIZE	80 Ripple	ESR	SIZE	100 Ripple	ESR
4.7	5 x 11	36	4.600	5 x 11	43	4.200	5 x 11	65	4.100
6.8	5 x 11	52	4.300	5 x 11	62	1.900	8 x 11	94	1.300
10	5 x 11	77	2.000	6 x 11	92	1.400	8 x 11	138	1.100
15	6 x 11	116	1.400	8 x 11	138	1.100	8 x 11	207	0.800
22	8 x 11	170	1.200	8 x 11	203	0.640	10 x 12	305	0.530
33	8 x 11	256	0.660	10 x 12	305	0.540	10 x 15	500	0.350
47	10 x 12	365	0.560	10 x 15	410	0.360	10 x 19	600	0.300
68	10 x 15	500	0.360	10 x 19	600	0.260	10 x 25	795	0.190
100	10 x 15	750	0.310	10 x 25	795	0.190	10 x 30	870	0.170
							13 x 20	955	0.150
120	10 x 19	820	0.270	10 x 30	900	0.170	12 x 30	1040	0.130
150	10 x 25	950	0.200	10 x 30	955	0.150	12 x 30	1200	0.110
180							13 x 25	1300	0.100
220	12 x 25	1150	0.160	12 x 30	1200	0.130	16 x 32	1440	0.086
330	12 x 30	1360	0.140	12 x 35	1450	0.088	16 x 32	1610	0.070
	13 x 25	1420	0.130				16 x 36	1790	0.062
470	12 x 35	1780	0.091	16 x 32	1790	0.063	16 x 40	2160	0.048
							18 x 36	2200	0.047
560									
680	16 x 32	2050	0.065	16 x 40	1990	0.058			
820	16 x 36	2200	0.056	18 x 36	2200	0.050			
1000	18 x 36	2330	0.049	18 x 40	2370	0.044			
1200	18 x 40	2520	0.046						
1500									
2200									
3300									
3900									
4700									
6800									
8200									
10000									
15000									

Note : * 1. D x L : mm

*2. Ripple Current : (mA r.m.s 105°C / 100KHz)

*3. ESR (Ω Max25°C / 100KHz)

Miniature Size Aluminum Electrolytic Capacitors

SY [For Low Impedance and Low E.S.R Suitable for Output of Mother Board]

105°C Single-Ended Lead Aluminum Electrolytic Capacitors For High Frequency Applications

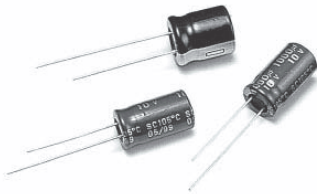

DESCRIPTION

Used in switching regulator applications in computers. Especially for high frequency.

Low impedance and E.S.R., high permissible ripple current at high frequency and higher operating temperature (-40°C to +105°C).

High Temperature Load Life at 105°C for 6000 Hours

Frequency coefficient

Frequency(Hz)	120	1K	10K	100K
22~180μF	0.40	0.75	0.90	1.00
220~560μF	0.50	0.85	0.94	1.00
680~1800μF	0.60	0.87	0.95	1.00
2200~3900μF	0.75	0.90	0.95	1.00
4700μF Higher	0.85	0.95	0.98	1.00

Temperature coefficient

Temperature(°C)	65	85	105
Factor	1.80	1.50	1.00

DIAGRAM OF DIMENSIONS

■ Dimensions[mm]

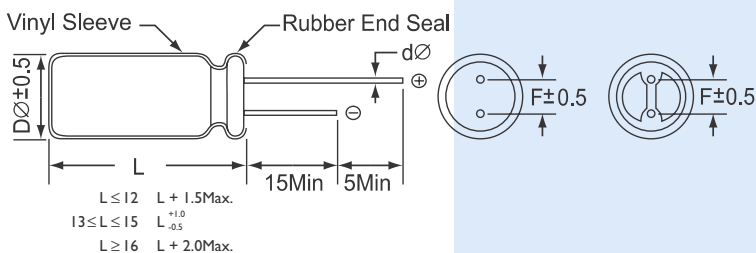

ELECTRICAL CHARACTERISTICS

Operating Temperature : -40° ~ +105°C

Working Voltage : 6.3 ~ 50V

Rate Capacitance Range : 22 ~ 15000μF

Capacitance Tolerance : -20 ~ +20%

DC Leakage Current (μA) : I = 0.01 CV(μA) or 3μA. Whichever is greater.

(Measurements shall be Made After a 2 Minute Charge at Rated Working Voltage)

Dissipation Factor : at 120 Hz, 25°C

WV (V) :	6.3	10	16	25	35	50
D.F (%) :	22	19	16	14	12	10

For capacitor whose capacitance exceeds 1000μF. The value of D.F(%) is increased by 2% for every addition of 1000μF.

WV (V) :	Rated Voltage (V)	6.3	10	16	25	35	50
Impedance :	Z - 25°C / Z + 20°C	4	3	2	2	2	2
Impedance :	Z - 40°C / Z + 20°C	8	6	4	3	3	3

Dø :	5ø~6.3ø	8ø~10øx12	10øx15~12ø	13ø~18ø
Life :	3000hrs	4000hrs	5000hrs	6000hrs

If dimension is down size , Endurance will be less 1000 hrs than standard.

- (a) Capacitance Change : Within 20% of Initial Value
- (b) Dissipation Factor : Not Exceed 200% of Initial Requirement
- (c) Leakage Current : Not Exceed the Initial Requirement

Shelf Life : 1000 Hours, No Voltage Applied, at 105°C

- (a) Capacitance Change : Within 20% of Initial Value
- (b) Dissipation Factor : Not more than 200% of specified value
- (c) Leakage Current : Not more than 200% of specified value

Dimensions : mm

Dø	F	dø
4.0	1.5	0.45
5.0	2.0	0.5
6.0	2.5	
8.0	3.5	
10.0	5.0	0.6
12.0		
13.0		
16.0	7.5	0.8
18.0		
22.0	10.0	0.8



CASE SIZE OF STANDARD PRODUCTS $D\phi \geq 6\text{mm}$ with Safety Vent at Can Bottom

CAP. (μF)	RATED VOLTAGE								
	6.3			10			16		
	Size	Ripple	Impedance	Size	Ripple	Impedance	Size	Ripple	Impedance
56							5 × 11	210	0.580
100				5 × 11	210	0.580			
120							6.3 × 11	340	0.220
150	5 × 11	210	0.580						
220	6 × 11	210	0.580	6 × 11	340	0.220			
330	6 × 11	340	0.220				8 × 11	640	0.130
470				8 × 11	640	0.130	8 × 15	840	0.087
							10 × 12	865	0.080
680	8 × 11	640	0.130	8 × 15	840	0.087	8 × 20	1050	0.069
							10 × 15	1210	0.060
820	10 × 12	865	0.080	10 × 12	865	0.080			
1000	8 × 15	840	0.087	8 × 20	1050	0.069	10 × 19	1400	0.046
				10 × 15	1210	0.060	13 × 15	1450	0.049
1200	8 × 20	1050	0.069	10 × 19	1400	0.046	10 × 25	1650	0.042
	10 × 15	1210	0.060						
	10 × 19	1400	0.046	10 × 25	1650	0.042	10 × 30	1910	0.031
1500				13 × 15	1450	0.049	13 × 20	1900	0.035
							16 × 15	1940	0.042
1800	13 × 15	1450	0.049						
	10 × 25	1650	0.042	10 × 30	1910	0.031	13 × 25	2230	0.027
2200				13 × 20	1900	0.042	18 × 15	2210	0.043
				16 × 15	1940	0.042			
2700	10 × 30	1910	0.031	18 × 15	2210	0.043	13 × 30	2650	0.024
	16 × 15	1940	0.042				16 × 20	2530	0.027
3300	13 × 20	1900	0.035	13 × 25	2230	0.027	13 × 35	2880	0.020
	13 × 25	2230	0.027	13 × 30	2650	0.024	13 × 40	3350	0.017
3900	18 × 15	2210	0.043	16 × 20	2530	0.027	16 × 25	2930	0.021
							18 × 20	2860	0.026
4700	13 × 30	2650	0.024	13 × 35	2880	0.020	16 × 32	3450	0.017
							18 × 25	3140	0.019
	13 × 35	2880	0.020	13 × 40	3350	0.017	16 × 36	3610	0.015
5600	16 × 20	2530	0.027	16 × 25	2930	0.021	18 × 32	4170	0.015
				18 × 20	2860	0.026			
	13 × 40	3350	0.017	16 × 32	3450	0.017	16 × 40	4080	0.013
6800	16 × 25	2930	0.021	18 × 25	3140	0.019			
	18 × 20	2860	0.026						
8200	16 × 32	3450	0.017	16 × 36	3610	0.015	18 × 36	4220	0.014
				18 × 32	4170	0.015			
10000	16 × 36	3610	0.015	16 × 40	4080	0.013	18 × 40	4280	0.012
	18 × 25	3140	0.017	18 × 36	4220	0.014			
12000	18 × 32	4170	0.015	18 × 40	4280	0.012			
15000	18 × 36	4220	0.014						

Note : * 1. D × L : mm

*2. Ripple Current : (mA r.m.s 105°C / 100KHz), Impedance (Ω Max25°C / 100KHz)



CASE SIZE OF STANDARD PRODUCTS $D\phi \geq 6\text{mm}$ with Safety Vent at Can Bottom

CAP. (μF)	RATED VOLTAGE								
	Size	25 Ripple	Impedance	Size	35 Ripple	Impedance	Size	50 Ripple	Impedance
22							5 × 11	180	0.700
33				5 × 11	210	0.580			
47	5 × 11	210	0.580						
56				6 × 11	340	0.220	6 × 11	295	0.300
100	6 × 11	340	0.220				8 × 11	555	0.170
120	6 × 11	340	0.220				8 × 15	730	0.120
150				8 × 11	640	0.130	10 × 12	760	0.120
180							8 × 20	910	0.091
220	8 × 11	640	0.130	8 × 15	840	0.087	10 × 15	1050	0.084
				10 × 12	865	0.080			
270				8 × 20	1050	0.069	10 × 19	1220	0.060
							13 × 15	1260	0.061
330	8 × 15	840	0.087	10 × 15	1210	0.060	10 × 25	1440	0.055
	10 × 12	865	0.080						
	8 × 20	1050	0.069	10 × 19	1400	0.046	10 × 30	1690	0.043
470	10 × 15	1210	0.060	13 × 15	1450	0.049	13 × 20	1660	0.045
							16 × 15	1690	0.055
560				10 × 25	1650	0.042	13 × 25	1950	0.034
							18 × 15	1930	0.054
	10 × 19	1400	0.046	10 × 30	1910	0.031	13 × 30	2310	0.030
680	13 × 15	1450	0.049	13 × 20	1900	0.035			
				16 × 15	1940	0.042			
820	10 × 25	1650	0.042				13 × 35	2510	0.025
							16 × 20	2210	0.034
	10 × 30	1910	0.031	13 × 25	2230	0.027	13 × 40	2920	0.021
1000	13 × 20	1900	0.035	18 × 15	2210	0.043	16 × 25	2555	0.025
	16 × 15	1940	0.042				18 × 20	2490	0.036
1200	18 × 15	2210	0.043	13 × 30	2650	0.024	16 × 32	3010	0.022
				16 × 20	2530	0.027	18 × 25	2740	0.026
1500	13 × 25	2230	0.027	13 × 35	2880	0.020	16 × 36	3150	0.019
	13 × 30	2650	0.024	13 × 40	3350	0.017	16 × 40	3710	0.016
1800	16 × 20	2530	0.027	16 × 25	2930	0.021	18 × 32	3635	0.021
				18 × 20	2860	0.026			
2200	13 × 35	2880	0.020	16 × 32	3450	0.017	18 × 36	3680	0.017
	18 × 20	2860	0.026	18 × 25	3140	0.019			
2700	13 × 40	3350	0.017	16 × 36	3610	0.015	18 × 40	3800	0.014
	16 × 25	2930	0.021	18 × 32	4170	0.015			
3300	16 × 32	3450	0.017	16 × 40	4080	0.013			
	16 × 25	3140	0.019	18 × 36	4220	0.014			
3900	18 × 32	4170	0.015	18 × 40	4280	0.012			
4700	18 × 36	4220	0.014						
5600	18 × 40	4280	0.012						

Note : * 1. D × L : mm

*2. Ripple Current : (mA r.m.s 105°C / 100KHz), Impedance (Ω Max25°C / 100KHz)

Miniature Size Aluminum Electrolytic Capacitors

SZ [Ultra Low ESR]

105°C Single-Ended Lead Aluminum Electrolytic Capacitors For High Frequency Applications

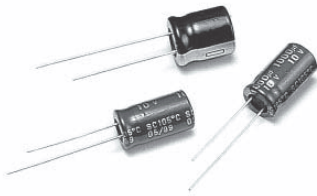

DESCRIPTION

Used in switching regulator applications in computers. Especially for high frequency.

Low impedance and E.S.R., high permissible ripple current at high frequency and higher operating temperature (-40°C to +105°C).

High Temperature Load Life at 105°C for 2000 Hours

Frequency coefficient

Frequency(Hz)	120	1K	10K	100K ≤
Factor	0.50	0.80	0.90	1.00

Temperature coefficient

Temperature(°C)	65	85	105
Factor	2.10	1.70	1.00

DIAGRAM OF DIMENSIONS

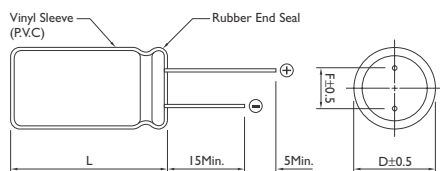

ELECTRICAL CHARACTERISTICS

Operating Temperature : -40° ~ +105°C

Working Voltage : 6.3 ~ 16V

Rate Capacitance Range : 470 ~ 3300μF

Capacitance Tolerance : -20 ~ +20%

DC Leakage Current (μA) : I = 0.03 CV Whichever is greater.

(Measurements shall be Made After a 2 Minute Charge at Rated Working Voltage)

Dissipation Factor : at 120 Hz, 25°C

WV (V) : $\frac{6.3}{22}$ - $\frac{10}{19}$ - $\frac{16}{16}$
 D.F (%) :

For capacitor whose capacitance exceeds 1000μF. The value of D.F(%) is increased by 2% for every addition of 1000μF.

WV (V) : Rated Voltage (V) $\frac{6.3}{2}$ - $\frac{10}{2}$ - $\frac{16}{2}$
 Impedance : $\frac{Z - 25°C}{3}$ / $\frac{Z + 20°C}{3}$
 Impedance : $\frac{Z - 40°C}{3}$ / $\frac{Z + 20°C}{3}$

Load Life : 2000 Hours at 105°C Assured with Full Rated Maximum Ripple Current Applied

- (a) Capacitance Change : Within 20% of Initial Value
- (b) Dissipation Factor : Not Exceed 200% of Initial Requirement
- (c) Leakage Current : Not Exceed the Initial Requirement

Shelf Life : 1000 Hours, No Voltage Applied, at 105°C

- (a) Capacitance Change : Within 20% of Initial Value
- (b) Dissipation Factor : Not Exceed 200 % of Initial Requirement
- (c) Leakage Current : Not Exceed 200% of Initial Requirement

Dimensions : mm

Rubber Stand-off

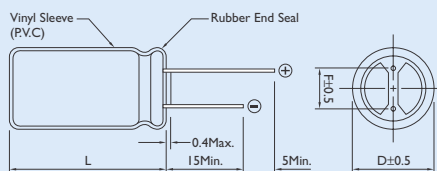

L ≤ 12 L + 1.5Max.
 13 ≤ L ≤ 15 L $\frac{+1.0}{-0.5}$
 L ≥ 16 L + 2.0Max.

Dø	F	dø
4.0	1.5	0.45
5.0	2.0	0.5
6.0	2.5	
8.0	3.5	
10.0	5.0	0.6
12.0		
13.0		
16.0	7.5	0.8
18.0		
22.0	10.0	0.8



CASE SIZE OF STANDARD PRODUCTS $D\phi \geq 6\text{mm}$ with Safety Vent at Can Bottom

CAP. (μF)	RATED VOLTAGE WV								
	SIZE	6.3 Ripple	ESR	SIZE	10 Ripple	ESR	SIZE	16 Ripple	ESR
470							8 x 11	1140	36
680				8 x 11	1140	36	8 x 15	1490	28
							10 x 12	1540	26
820	8 x 11	1140	36						
1000				8 x 15	1490	28	8 x 20	1870	19
				10 x 12	1540	26	10 x 15	2000	19
1200	8 x 15	1490	28						
1500	10 x 12	1540	26	8 x 20	1870	19	10 x 19	2550	13
				10 x 15	2000	19			
1800	8 x 20	1870	19	10 x 19	2550	13	10 x 22	2800	12
	10 x 15	2000	19						
2200	10 x 19	2550	13	10 x 22	2800	12			
3300	10 x 22	2800	12						

Note : * 1. D x L : mm

*2. Ripple Current : (mA r.m.s 105°C / 100KHz), ESR ($M\Omega$ Max25°C / 100KHz)

Miniature Size Aluminum Electrolytic Capacitors

SQ [High Temperature for +125°C]

125°C Single-Ended Lead Aluminum Electrolytic Capacitors For High Frequency Applications

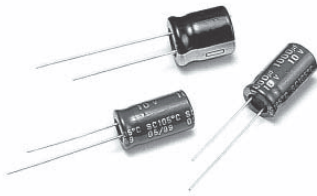

DESCRIPTION

Wide operating temperature range it as long load life product at 125°C

Suit for use in DC or pulse circuits in various electronic and industrial

ELECTRICAL CHARACTERISTICS

Operating Temperature : -40° ~ +125°C

Working Voltage : 10 ~ 50V

Rate Capacitance Range : 4.7 ~ 3900μF

Capacitance Tolerance : -20 ~ +20%

DC Leakage Current (μA) : $1 \leq 0.03 CV(\mu A)$ or $4\mu A$ Whichever is greater.

(Measurements shall be Made After a 2 Minute Charge at Rated Working Voltage)

Dissipation Factor : at 120 Hz, 25°C

WV (V) :	10	16	25	35	50	-----
D.F (%) :	15	12	10	10	8	-----

Value in () are applicable for products which dimensions are in ().

WV (V) :	Rated Voltage (V)	10	16	25	35	50
Impedance :	Z - 25°C / Z + 20°C	3	2	2	2	2
Impedance :	Z - 40°C / Z + 20°C	6	4	4	4	4

Load Life : 1000 Hours at 125°C Assured with Full Rated Maximum Ripple Current Applied

- (a) Capacitance Change : Within 20% of Initial Value
- (b) Dissipation Factor : Not Exceed 200% of Initial Requirement
- (c) Leakage Current : Not Exceed the Initial Requirement

Shelf Life : 1000 Hours, No Voltage Applied, at 125°C

- (a) Capacitance Change : Within 20% of Initial Value
- (b) Dissipation Factor : Not Exceed 200 % of Initial Requirement
- (c) Leakage Current : Not Exceed 200% of Initial Requirement

DIAGRAM OF DIMENSIONS

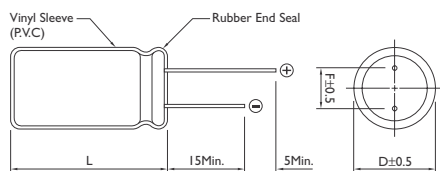

Rubber Stand-off

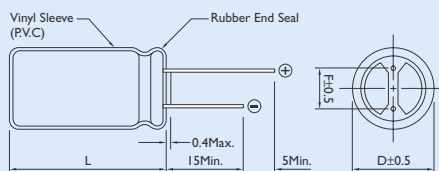

$L \leq 12$ $L + 1.5\text{Max.}$
 $13 \leq L \leq 15$ $L^{+1.0}_{-0.5}$
 $L \geq 16$ $L + 2.0\text{Max.}$

Dimensions : mm

Dø	F	dø
4.0	1.5	0.45
5.0	2.0	0.5
6.0	2.5	
8.0	3.5	
10.0	5.0	0.6
12.0		
13.0		
16.0	7.5	0.8
18.0		
22.0	10.0	0.8



CASE SIZE & PERMISSIBLE RIPPLE CURRENT OF STANDARD PRODUCTS

CAP. (μ F)	RATED VOLTAGE WV				
	10	16	25	35	50
0.47					8 x 11
1					8 x 11
2.2					8 x 11
3.3					8 x 11
4.7					8 x 11
10					8 x 11
22				8 x 11	10 x 12
33			8 x 11	10 x 12	10 x 15
47		8 x 11	10 x 12	10 x 15	10 x 19
100	10 x 12	10 x 15	10 x 19	13 x 20	13 x 25
220	10 x 19	13 x 20	13 x 25	16 x 25	
330	13 x 20	13 x 25	16 x 25		
470	13 x 25	16 x 25			
1000			16 x 32		
2200			16 x 32		
3900			18 x 36		

Note : * L, D x L : mm

Miniature Size Aluminum Electrolytic Capacitors

SV [For adapter and power supply applications Series]

105°C Single-Ended Lead Aluminum Electrolytic Capacitors For High Frequency Applications

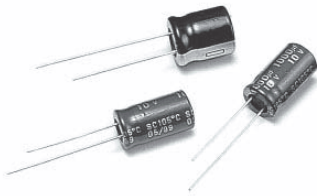

DESCRIPTION

Used in switching regulator applications in computers. Especially for high frequency.

Low impedance and E.S.R., high permissible ripple current at high frequency and higher operating temperature (-40°C to +105°C).

Frequency coefficient

Frequency(Hz)	120	500	1K	10K~100K
Coefficient	1.00	1.20	1.40	1.50

Temperature coefficient

Temperature(°C)	65	85	105
Factor	2.10	1.70	1.00

DIAGRAM OF DIMENSIONS

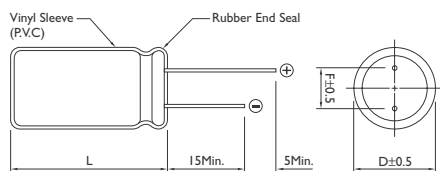

Rubber Stand-off

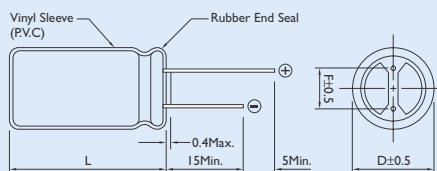

$L \leq 12$ $L + 1.5\text{Max.}$
 $13 \leq L \leq 15$ $L^{+1.0}_{-0.5}$
 $L \geq 16$ $L + 2.0\text{Max.}$

Dimensions : mm

Dø	F	dø
4.0	1.5	0.45
5.0	2.0	0.5
6.0	2.5	
8.0	3.5	
10.0	5.0	0.6
12.0		
13.0		
16.0	7.5	0.8
18.0		
22.0	10.0	0.8

ELECTRICAL CHARACTERISTICS

Operating Temperature : -40° ~ +105°C -25° ~ +105°C

Working Voltage : 200V 400V

Rate Capacitance Range : 22 ~ 220µF 10 ~ 150µF

Capacitance Tolerance : -20 ~ +20%

DC Leakage Current (µA) : $I = 0.06 CV + 10(\mu A)$

whichever is greater.(After 2 minutes application of rated voltage at 25°C)

Dissipation Factor : at 120 Hz, 25°C

$\frac{WV(V)}{D.F.(\%)}$: $\frac{200}{15}$ $\frac{400}{20}$

$\frac{WV(V)}{\text{Impedance}}$: $\frac{200}{3}$ $\frac{400}{5}$
 Impedance : $Z_{-25^\circ C} / Z_{+20^\circ C}$ 3 5
 Impedance : $Z_{-40^\circ C} / Z_{+20^\circ C}$ 6 $-$

Load Life : After apply rated voltage with rated ripple current for 2000hrs at 105°C the capacitors shall meet the following requirements.

- (a) Capacitance Change : Within 20% of Initial Value
- (b) Dissipation Factor : Not Exceed 200% of Initial Requirement
- (c) Leakage Current : Not Exceed the Initial Requirement

Shelf Life : 1000 Hours, No Voltage Applied, at 105°C

- (a) Capacitance Change : Within 20% of Initial Value
- (b) Dissipation Factor : Not Exceed 200 % of Initial Requirement
- (c) Leakage Current : Not Exceed 200% of Initial Requirement



PERMISSIBLE RIPPLE CURRENT (mA, rms) at 105°C, 120HZ

CAP. (μF)	RATED VOLTAGE WV			
	Size	200 Ripple	Size	400 Ripple
10			10 × 15	64
			10 × 19	120
			13 × 25	200
22	10 × 19	233	12 × 25	190
			13 × 25	225
			16 × 25	300
33	13 × 20	366	16 × 20	360
			16 × 25	400
			16 × 32	437
47	13 × 25	400	13 × 30	370
			16 × 25	450
			18 × 25	470
			18 × 32	538
68	13 × 25	600	13 × 40	480
			18 × 25	480
82			16 × 32	520
			18 × 32	520
100	16 × 32	800	18 × 32	580
120			18 × 32	670
			18 × 32	670
150			18 × 36	700
220	16 × 36	933		

Note : * 1. D × L : mm

*2. Ripple Current : (mA rms 105°C / 120Hz)

Miniature Size Aluminum Electrolytic Capacitors

SF [For Photo Flash Applications]

105°C Single-Ended Lead, 5.0mm Height Type Aluminum Electrolytic Capacitors

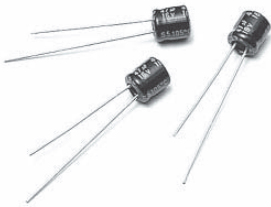

DESCRIPTION

Applications : Digital Camera

ELECTRICAL CHARACTERISTICS

Operating Temperature : -25° ~ +55°C

Working Voltage : 300, 330, 360V

Rate Capacitance Range : 36 ~ 300μF

Capacitance Tolerance : -10 ~ +20%

DC Leakage Current : $I = 1 \times C (\mu A)$ max.(After 5 minute)

Dissipation Factor : Less than 0.06

Charge and Discharge Characteristics :

Test condition : For 5000 times at room temperature (5~35°C)

Charge & discharge cycles : 30 sec

Leakage current : $\leq 150\%$ of initial specified value

Capacitance change : within $\pm 10\%$ of initial value

tan d(DF) : $\leq 150\%$ of initial specified value

Shelf Life:

Storage without voltage applied at 55°C for 1000 hours and measured at 25°C

(a) Leakage current : $\leq 150\%$ of initial specified value

(b) Capacitance change : within $\pm 20\%$ of initial value

(c) tan δ (DF) : $\leq 150\%$ of initial specified value

DIAGRAM OF DIMENSIONS

Dimensions : mm

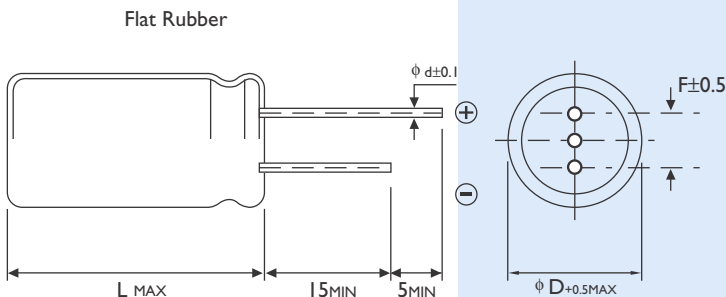

Dø	F	dø
10	5.0	0.6
12.5	5.0	0.8
13	5.0	0.8
14.5	7.5	0.8
16	7.5	0.8
18	7.5	0.8
20	7.5	0.8



CASE SIZE & PERMISSIBLE RIPPLE CURRENT OF STANDARD PRODUCTS

CAP. (μ F)	RATED VOLTAGE WV						
	10	12.5	13	14.5	16	18	20
36	10 x 27						
47	10 x 30	12.5 x 20					
60	10 x 34	12.5 x 23					
80		12.5 x 27					
100		12.5 x 34	13 x 34	14.5 x 26			
120		12.5 x 37	13 x 34	14.5 x 30	16 x 27		
140		12.5 x 42	13 x 39	14.5 x 33	16 x 29	18 x 25	
160		12.5 x 47	13 x 43	14.5 x 36	16 x 32	18 x 27	
180				14.5 x 40	16 x 35	18 x 29	
200				14.5 x 43	16 x 38	18 x 31	
220				14.5 x 47	16 x 40	18 x 33	
240					16 x 43	18 x 36	
250						18 x 37	20 x 31
300						18 x 42	20 x 35

Note : * 1. D x L : mm

* 2. Flat Rubbet

Miniature Size Aluminum Electrolytic Capacitors

LH [For 85°C, 2000 Hours Miniature]

For Printed Circuit Board High-Performance Aluminum Electrolytic Power Supply Input and Output Filter Capacitors

ELECTRICAL CHARACTERISTICS

Operating Temperature Range	-40 to +85°C	-25 to +85°C
Rated Voltage Range	6.3 to 100VDC	160 to 450VDC
Capacitance Tolerance	±20% (at 25°C, 120Hz)	
Leakage Current	I = 0.02CV or 3mA Whichever is smaller. (At 25°C, After 5 Minutes Application of DC Working Voltage at 25°C)	
Dissipation Factor	Where, I; Leakage Current (μA) C: Nominal Capacitance (μF) V; Rated Voltage (V)	
	Rate Voltage (V)	6.3 10 16 25 35 50~80 100 160~250 315~450
	D.F (%)	60 50 40 25 25 20 15 10* 15
	Note: * (15%) For Case Size D = 35m/m or L = 20m/m (At 120Hz, 25°C) (WV = 6.3 ~ 100V For Capacitor Whose Capacitance Exceeds 1000μF The value of D.F.(%) is increased by 2% for every addition of 1000μF.	
Load Life	After the capacitors are subjected to DC with the full rated ripple current applied at 85°C for 2000 hours. The following specifications shall be satisfied when the capacitors are restored to 25°C the sum of DC voltage and peak AC voltage must not exceed their full rated voltage.	
	Capacitance Change	≤ ±20% of the Initial Value
	D.F. (tanδ)	≤ 200% of the Initial Specified Value
	Leakage Current	≤ the Initial Specified Value
Shelf Life	The following specifications shall be satisfied when the capacitor are restored to 25°C after exposing them for 1000 hours at 85°C without voltage applied.	
	Capacitance Change	≤ ±20% of the Initial Value
	D.F. (%)	≤ 150% of the Initial Specified Value
	Leakage Current	≤ 150% of the Initial Specified Value

DIAGRAM OF DIMENSIONS

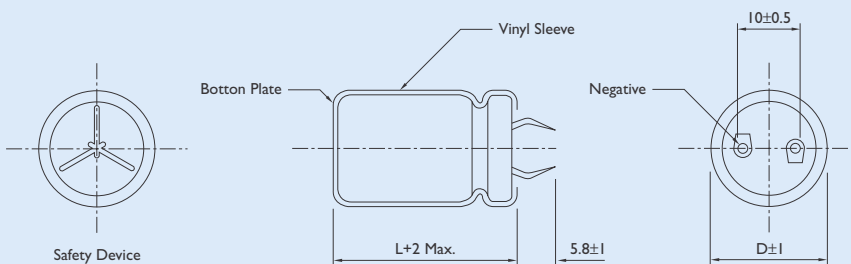

DESCRIPTION

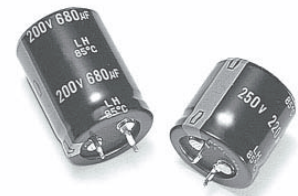

LH type capacitors, size are combined with snap-lock terminals for easy to mount on P.C. Board.

They are ideally suitable to be used in switching.

Power Supplies and Orther Industrial or Commercial Applications

Multiplier for Ripple Current

Frequency coefficient

Frequency(Hz)	50	60	120	1K	10K~00K
6.3~100V	0.88	0.90	1.00	1.15	1.16
160~250V	0.75	0.78	1.00	1.16	1.23
350~450V	0.74	0.76	1.00	1.10	1.15

Temperature coefficient

Temperature(°C)	60	70	85
Factor	1.42	1.30	1.00

Unit : mm

Location of P.C.B. Holes

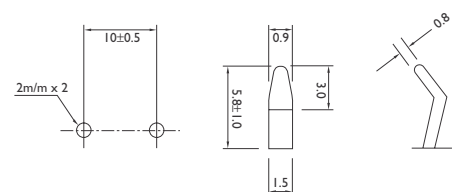



CASE SIZE OF STANDARD PRODUCTS AND PERMISSIBLE RIPPLE CURRENT

CAP. (μF)	RATED VOLTAGE WV							
	6.3		10		16		25	
	Size	Ripple	Size	Ripple	Size	Ripple	Size	Ripple
5600							22 × 25	2.20
6800							22 × 30 25 × 25	2.40 2.45
8200					22 × 25	2.60	22 × 35 25 × 25	2.70 2.75
10000					22 × 30 25 × 25	2.70 2.75	22 × 40 25 × 30 30 × 25	3.10 3.15 3.20
12000			22 × 25	2.40	22 × 30 25 × 25	2.90 2.95	22 × 45 25 × 35 30 × 30 35 × 25	3.50 3.45 3.50 3.55
15000	22 × 25	2.44	22 × 30 25 × 25	2.75 2.75	22 × 35 25 × 30 30 × 25	3.30 3.45 3.50	22 × 50 25 × 40 30 × 35 35 × 30	4.00 3.95 4.00 4.05
18000	22 × 30 25 × 25	2.60 2.62	22 × 35 25 × 25	3.15 3.05	22 × 40 25 × 35 30 × 30	3.70 3.75 3.80	25 × 45 30 × 35 35 × 30	4.45 4.45 4.60
22000	22 × 30 25 × 25	3.06 3.07	22 × 40 25 × 30 30 × 25	3.55 3.50 3.55	22 × 50 25 × 40 30 × 30 35 × 25	4.35 4.30 4.25 4.20	30 × 40 35 × 35	5.20 5.15
27000	22 × 35 25 × 30 30 × 25	3.49 3.52 3.57	22 × 45 25 × 35 30 × 30	4.05 4.00 4.05	25 × 45 30 × 35 35 × 30	4.70 4.65 4.65	30 × 45 35 × 40	5.95 5.90
33000	22 × 40 25 × 35 30 × 30 35 × 25	3.97 4.02 4.05 4.10	22 × 50 25 × 40 30 × 30 35 × 25	4.60 4.55 4.50 4.50	30 × 40 35 × 30	5.35 5.40	30 × 50 35 × 45	6.70 6.75
39000	22 × 50 25 × 40 30 × 30 35 × 25	4.56 4.50 4.46 4.51	25 × 45 30 × 35 35 × 30	5.10 5.05 5.05	30 × 45 35 × 35	6.00 5.95	35 × 50	7.55
47000	25 × 45 30 × 35 35 × 30	5.09 5.06 5.03	25 × 50 30 × 40 35 × 30	5.75 5.70 5.65	30 × 50 35 × 40	6.80 6.75		
56000	25 × 50 30 × 40 35 × 30	5.71 5.70 5.75	30 × 45 35 × 35	6.45 6.40	35 × 45	7.60		
68000	30 × 45 35 × 35	6.48 6.42	30 × 50 35 × 40	7.05 7.10	35 × 50	8.00		
82000	30 × 50 35 × 40	7.32 7.29	35 × 50	7.50				
100000	35 × 45	8.31						
120000	35 × 50	8.60						

Note : *1. D × L : mm

*2. Ripple Current : (mA r.m.s 85°C / 120Hz)



CASE SIZE OF STANDARD PRODUCTS AND PERMISSIBLE RIPPLE CURRENT

CAP. (μF)	RATED VOLTAGE WV							
	35		50		63		80	
	Size	Ripple	Size	Ripple	Size	Ripple	Size	Ripple
1200							22 × 25	1.65
1500							22 × 30	1.90
							25 × 25	1.90
1800					22 × 25	1.85	22 × 35	2.20
							25 × 30	2.20
							30 × 25	2.20
2200			22 × 25	1.90	22 × 30	2.30	22 × 40	2.45
					25 × 25	2.30	25 × 30	2.45
							30 × 25	2.50
2700			22 × 30	2.10	22 × 35	2.45	22 × 45	2.80
			25 × 25	2.20	25 × 30	2.45	25 × 35	2.80
					30 × 25	2.50	30 × 30	2.85
							35 × 25	2.85
3000			22 × 30	2.35	22 × 40	2.60	22 × 50	3.15
			25 × 25	2.35	25 × 30	2.65	25 × 40	3.20
					30 × 25	2.70	30 × 30	3.20
							35 × 25	3.20
3900	22 × 25	2.20	22 × 35	2.65	22 × 45	2.95	25 × 45	3.60
			25 × 30	2.65	25 × 35	2.95	30 × 35	3.60
			30 × 25	2.65	30 × 30	3.00	35 × 30	3.60
4700	22 × 30	2.40	22 × 40	3.00	22 × 50	3.40	25 × 50	4.05
	25 × 25	2.40	25 × 35	3.00	25 × 40	3.35	30 × 40	4.05
			30 × 25	2.95	30 × 30	3.35	35 × 35	4.10
				35 × 25	3.40			
5600	22 × 35	2.75	22 × 45	3.35	25 × 45	3.70	30 × 45	4.55
	25 × 25	2.75	25 × 40	3.35	30 × 35	3.75	35 × 35	4.50
			30 × 30	3.35	35 × 30	3.75		
			35 × 25	3.40				
6800	22 × 40	2.85	22 × 50	3.80	30 × 40	4.25	30 × 50	5.15
	25 × 30	2.85	25 × 40	3.80	35 × 30	4.20	35 × 40	5.15
	30 × 25	2.90	30 × 30	3.80				
			30 × 35	3.85				
			35 × 30	3.85				
8200	22 × 45	3.15	25 × 50	4.35	30 × 45	4.80	35 × 45	5.85
	25 × 35	3.10	30 × 40	4.35	35 × 35	4.80		
	30 × 30	3.15	35 × 30	4.40				
10000	22 × 50	3.55	30 × 45	5.00	30 × 50	5.50	35 × 50	6.60
	25 × 40	3.50	35 × 35	4.95	35 × 40	5.45		
	30 × 30	3.45						
	35 × 25	3.40						
12000	25 × 45	3.95	30 × 50	5.60	35 × 45	6.20		
	30 × 35	4.00	35 × 40	5.55				
	35 × 30	4.05						
15000	25 × 50	4.95	35 × 45	6.45				
	30 × 40	4.95						
	35 × 35	5.00						
18000	30 × 45	5.50	35 × 50	6.70				
	35 × 40	5.55						
22000	30 × 50	6.00						
	35 × 45	6.05						
27000	35 × 50	6.90						

Note : *1. D × L : mm

*2. Ripple Current : (mA r.m.s 85°C / 120Hz)



CASE SIZE OF STANDARD PRODUCTS AND PERMISSIBLE RIPPLE CURRENT

CAP. (μF)	RATED VOLTAGE WV							
	100		160		180		200	
	Size	Ripple	Size	Ripple	Size	Ripple	Size	Ripple
180					22 × 20	1.00	22 × 25	0.95
220					22 × 25	1.10	22 × 25	1.10
270			22 × 25	1.15	22 × 25	1.25	22 × 25	1.25
					25 × 20	1.25	22 × 30	1.25
							25 × 25	1.25
330			22 × 25	1.40	22 × 25	1.40	22 × 25	1.45
			25 × 20	1.35	22 × 30	1.40	22 × 30	1.45
					25 × 25	1.40	25 × 25	1.45
390			22 × 30	1.55	22 × 30	1.60	22 × 30	1.60
			25 × 25	1.55	25 × 25	1.60	25 × 25	1.55
			30 × 25	1.50				
470			22 × 30	1.75	22 × 35	1.80	22 × 35	1.80
			25 × 25	1.75	25 × 30	1.80	25 × 30	1.80
			30 × 25	1.70	30 × 25	1.80	30 × 25	1.80
560			22 × 30	1.95	22 × 35	2.00	22 × 40	2.00
			25 × 30	1.95	22 × 40	2.00	25 × 35	2.00
			30 × 25	1.90	25 × 30	1.95	30 × 25	2.00
					30 × 25	2.00		
680			22 × 40	2.20	22 × 45	2.25	22 × 45	2.35
			25 × 30	2.20	25 × 35	2.20	25 × 35	2.30
			30 × 25	2.15	30 × 30	2.20	30 × 30	2.30
					30 × 25	2.20	35 × 25	2.30
820	22 × 25	1.85	22 × 45	2.50	22 × 50	2.55	25 × 40	2.60
			25 × 35	2.55	25 × 40	2.55	25 × 45	2.60
			30 × 30	2.50	30 × 30	2.60	30 × 30	2.60
			35 × 25	2.50	30 × 35	2.60	30 × 35	2.60
					35 × 25	2.60	35 × 30	2.60
1000	22 × 30	2.10	22 × 50	2.85	25 × 45	2.85	25 × 45	3.00
	25 × 25	2.10	25 × 40	2.80	30 × 35	2.85	25 × 50	3.00
			30 × 35	2.80	35 × 30	2.90	30 × 35	3.05
			35 × 25	2.80			30 × 40	3.05
							35 × 30	3.00
1200	22 × 35	2.40	25 × 45	3.15	30 × 40	3.25	25 × 50	3.30
	25 × 30	2.45	30 × 35	3.15	35 × 30	3.30	30 × 40	3.30
			35 × 30	3.20	35 × 35	3.30	30 × 45	3.30
							35 × 30	3.30
							35 × 35	3.30
1500	22 × 40	2.70	30 × 45	3.75	30 × 45	3.85	30 × 50	3.80
	25 × 30	2.75	35 × 30	3.70	35 × 35	3.80	35 × 40	3.80
	30 × 25	2.75	35 × 35	3.70	35 × 40	3.80		
1800	22 × 45	3.10	30 × 50	4.20	35 × 40	4.30	35 × 45	4.35
	25 × 35	3.15	35 × 40	4.20	35 × 45	4.30		
	30 × 30	3.15						
	35 × 25	3.15						
2200	22 × 50	3.50	35 × 40	4.60	35 × 45	4.90	35 × 45	4.95
	25 × 40	3.55	35 × 45	4.80	35 × 50	4.90	35 × 50	4.95
	30 × 30	3.55						
	35 × 25	3.60						
2700	25 × 45	4.10	35 × 50	5.45				
	30 × 35	4.05						
	35 × 25	4.05						
3300	25 × 50	4.50						
	30 × 40	4.55						
	35 × 30	4.50						
3900	30 × 45	5.15						
	35 × 35	5.10						
4700	35 × 40	5.75						
5600	35 × 50	6.20						

Note : *1. D × L : mm

*2. Ripple Current : (mA r.m.s 85°C / 120Hz)



CASE SIZE OF STANDARD PRODUCTS AND PERMISSIBLE RIPPLE CURRENT

CAP. (μF)	RATED VOLTAGE WV							
	250		350		400		450	
	Size	Ripple	Size	Ripple	Size	Ripple	Size	Ripple
47							22 × 25	0.50
56					22 × 20	0.55	25 × 25	0.65
68			22 × 20	0.55	22 × 25	0.60	22 × 30	0.70
					22 × 20	0.60	22 × 25	0.70
82			22 × 25	0.65	22 × 25	0.80	22 × 30	0.80
			25 × 20	0.65	25 × 20	0.80	25 × 25	0.80
100			22 × 30	0.90	22 × 30	0.90	22 × 35	0.95
			25 × 20	0.90	25 × 25	0.90	25 × 30	0.95
							30 × 25	0.95
120	22 × 20	0.78	22 × 30	1.00	22 × 35	1.05	22 × 40	1.05
			25 × 25	1.00	25 × 25	1.05	25 × 30	1.05
							30 × 25	1.05
150	22 × 25	0.90	22 × 35	1.15	22 × 35	1.15	22 × 45	1.20
			25 × 30	1.15	25 × 30	1.15	25 × 35	1.20
			30 × 25	1.15	30 × 25	1.15	30 × 30	1.20
180	22 × 25	1.05	22 × 40	1.30	22 × 45	1.30	25 × 40	1.35
	25 × 20	1.00	25 × 30	1.25	25 × 35	1.30	30 × 35	1.35
			30 × 25	1.25	30 × 30	1.35	35 × 25	1.35
220	22 × 30	1.15	22 × 45	1.45	22 × 50	1.50	25 × 50	1.55
	22 × 35	1.15	25 × 35	1.45	25 × 40	1.50	30 × 40	1.55
	25 × 25	1.15	30 × 30	1.45	30 × 30	1.50	35 × 30	1.55
			35 × 25	1.45	35 × 25	1.50		
270	22 × 30	1.30	25 × 40	1.65	25 × 40	1.65	30 × 45	1.75
	25 × 25	1.30	30 × 35	1.65	30 × 35	1.65	35 × 35	1.70
			35 × 25	1.65	35 × 30	1.65		
330	22 × 35	1.50	25 × 50	1.80	25 × 50	1.90	30 × 50	2.00
	25 × 25	1.50	30 × 40	1.80	30 × 40	1.90	35 × 40	2.00
	30 × 25	1.50	35 × 30	1.80	35 × 30	1.85		
390	22 × 40	1.65	30 × 40	2.00	30 × 45	2.15	35 × 45	2.25
	25 × 35	1.65	35 × 30	2.00	35 × 35	2.10		
	30 × 25	1.65						
470	22 × 40	1.85	30 × 45	2.25	30 × 50	2.40	35 × 50	2.50
	25 × 35	1.85	35 × 35	2.25	35 × 40	2.40		
	30 × 30	1.90						
	35 × 25	1.90						
560	22 × 45	2.10	35 × 40	2.50	35 × 45	2.70		
	25 × 40	2.10						
	30 × 30	2.10						
	35 × 25	2.10						
680	25 × 45	2.45	35 × 45	2.90	35 × 50	2.90	35 × 60	2.9
	30 × 35	2.45						
	35 × 30	2.45						
820	30 × 45	2.75						
	35 × 30	2.75						
1000	30 × 50	3.30						
	35 × 40	3.30						
1200	35 × 40	3.55						
1500	35 × 45	4.05						

Note : *1. D × L : mm

*2. Ripple Current : (mA r.m.s 85°C / 120Hz)

Miniature Size Aluminum Electrolytic Capacitors

LG [For 105°C, 2000 Hours General]

For Printed Circuit Board High-Performance Aluminum Electrolytic Power Supply Input and Output Filter Capacitors



DESCRIPTION (LG Series 105°C 2000 Hours Assured)

LG type capacitors are combined with snaplock terminals for easy to mount on P.C. Board.

They are ideally suitable to be used in switching power supplies and other industrial or commercial applications.

Multiplier for Ripple Current

Frequency coefficient

Frequency(Hz)	50	60	120	1K	10K~00K
6.3~100V	0.88	0.90	1.00	1.15	1.16
160~250V	0.85	0.88	1.00	1.15	1.20
315~450V	0.88	0.9	1.00	1.10	1.15

Temperature coefficient

Temperature(°C)	60	70	85	105
Factor	2.37	2.17	1.67	1.00

DIAGRAM OF DIMENSIONS

Unit : mm

Location of P.C.B. Holes

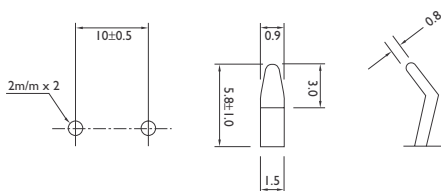

ELECTRICAL CHARACTERISTICS

Rated Voltage Range	6.3 to 100VDC	160 to 450VDC
Operating Temperature Range	-40 to +105°C	-25 to +105°C
Capacitance Tolerance	±20% (At 25°C, 120Hz)	
Leakage Current	I = 0.02CV, L = 20m/m, I = 0.03CV or 3mA Whichever is smaller. (At 25°C, After 5 Minutes)	
Dissipation Factor (tanδ)	Where, I; Leakage Current (μA) C: Nominal Capacitance (μF) V; Rated Voltage (V)	
	Rate Voltage (V)	6.3 10 16 25 35 50~80 100 160~250 315~450
	D.F (%)	60 50 40 25 25 20 15 10* 15
	* Note : 15% For D = 35m/m or L = 20m/m (At 25°C, 120Hz)	
	(WV = 6.3 ~ 100V For Capacitor Whose Capacitance Exceeds 1000μF)	
	The value of D.F (%) is increased by 2% for every addition of 1000μF)	
Low Temperature Characteristics (120Hz)	Rated Voltage (V)	6.3~16 25 35 50~63 80~100 160~400 450
	Z(-25°C) / Z(20°C)	4 3 3 2 2 4 8
	Z(-40°C) / Z(20°C)	15 10 8 6 5 - -
Load Life	The following specifications shall be satisfied when the capacitors are restored to 25°C after the rated voltage with maximum ripple current is applied for 2000 hours at 105°C.	
	Capacitance Change	≤ ±20% of the Initial Value
	D.F	≤ 200% of the Initial Specified Value
	Leakage Current	≤ the Initial Specified Value
Shelf Life	The following specifications shall be satisfied when the capacitor are restored to 25°C after exposing them for 1000 hours at 105°C without voltage applied.	
	Capacitance Change	≤ ±20% of the Initial Value
	D.F	≤ 150% of the Initial Specified Value
	Leakage Current	≤ 150% of Initial Specified Value

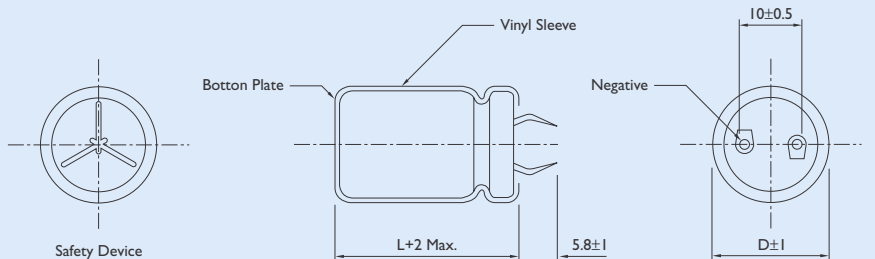



CASE SIZE OF STANDARD PRODUCTS AND PERMISSIBLE RIPPLE CURRENT

CAP. (μF)	RATED VOLTAGE WV							
	6.3		10		16		25	
	Size	Ripple	Size	Ripple	Size	Ripple	Size	Ripple
4700							22 × 25	1.50
5600							22 × 30 25 × 25	1.65 1.65
6800					22 × 25	1.55	22 × 30 25 × 25	1.85 1.85
8200					22 × 30 25 × 25	1.70 1.70	22 × 35 25 × 30 30 × 25	2.10 2.10 2.15
10000			25 × 25	1.55	22 × 30 25 × 25	1.95 1.95	22 × 40 25 × 35 30 × 30 35 × 25	2.40 2.40 2.40 2.40
12000	22 × 25	1.55	22 × 30	1.75	22 × 35 25 × 30 30 × 25	2.20 2.25 2.30	22 × 45 25 × 40 30 × 30 35 × 25	2.70 2.75 2.70 2.75
15000	22 × 30 25 × 25	1.70 1.70	22 × 30 25 × 25	1.90 1.90	22 × 40 25 × 35 30 × 30 35 × 25	2.55 2.60 2.60 2.65	25 × 45 30 × 35 35 × 30	3.15 3.15 3.25
18000	22 × 30 25 × 25	1.95 1.95	22 × 35 25 × 30	2.20 2.25	22 × 45 25 × 40 30 × 30 35 × 25	2.90 2.90 2.90 2.95	25 × 50 30 × 40 35 × 35	3.55 3.55 3.55
22000	22 × 35 25 × 30 30 × 25	2.25 2.25 2.25	22 × 40 25 × 35 30 × 25	2.50 2.55 2.45	25 × 45 30 × 35 35 × 30	3.30 3.30 3.30	30 × 45 35 × 35	4.05 3.80
27000	22 × 40 25 × 35 30 × 30 35 × 25	2.55 2.55 2.55 2.55	22 × 50 25 × 40 30 × 30 35 × 25	2.95 2.90 2.85 2.80	25 × 50 30 × 40 35 × 30	3.80 3.75 3.75	35 × 45	4.70
33000	22 × 45 25 × 40 30 × 30 35 × 25	2.90 2.95 2.90 2.95	25 × 45 30 × 35 35 × 30	3.30 3.30 3.30	30 × 45 35 × 35	4.30 4.25	35 × 50	5.40
39000	25 × 50 30 × 35 35 × 30	3.25 3.25 3.30	25 × 50 30 × 40 35 × 30	3.70 3.70 3.65	30 × 50 35 × 40	4.80 4.80		
47000	25 × 50 30 × 40	3.70 3.70	30 × 45 35 × 35	4.20 3.80	35 × 45	5.45		
56000	30 × 45 35 × 35	4.15 4.10	30 × 50 35 × 40	4.65 4.65				
68000	30 × 50 35 × 40	4.70 4.70	35 × 50	5.50				
82000	35 × 45	5.30						

Note : *1. D × L : mm

*2. Ripple Current : (mA r.m.s 105°C / 120Hz)



CASE SIZE OF STANDARD PRODUCTS AND PERMISSIBLE RIPPLE CURRENT

CAP. (μF)	RATED VOLTAGE WV							
	35		50		63		80	
	Size	Ripple	Size	Ripple	Size	Ripple	Size	Ripple
820							22 × 25	1.10
1000							22 × 30 25 × 25	1.20 1.20
1200					22 × 25	1.20	22 × 30 25 × 25	1.40 1.40
1500					22 × 30 25 × 25	1.30 1.30	22 × 35 25 × 30 30 × 25	1.60 1.60 1.65
1800			22 × 25	1.30	22 × 30 25 × 25	1.50 1.50	22 × 40 25 × 35 30 × 25	1.80 1.85 1.80
2200			22 × 30 25 × 25	1.55 1.55	22 × 35 25 × 30 30 × 25	1.70 1.75 1.80	22 × 45 25 × 35 30 × 30 35 × 25	2.05 2.00 2.05 2.05
2700			22 × 30 25 × 25	1.70 1.70	22 × 40 25 × 35 30 × 25	2.00 2.00 1.95	25 × 45 30 × 35 35 × 30	2.35 2.35 2.35
3300	22 × 25	1.40	22 × 35 25 × 30	1.95 1.85	22 × 50 25 × 40 30 × 30 35 × 25	2.30 2.30 2.25 2.10	25 × 50 30 × 40 35 × 30	2.70 2.70 2.55
3900	22 × 30 25 × 25	1.55 1.55	22 × 40 25 × 35 30 × 25	2.15 2.20 1.95	25 × 45 30 × 35 35 × 30	2.55 2.55 2.55	30 × 45 35 × 35	3.00 3.00
4700	22 × 35 25 × 25	1.80 1.80	22 × 45 25 × 40 30 × 30 35 × 25	2.45 2.45 2.45 2.50	25 × 50 30 × 40 35 × 30	2.85 2.85 2.80	30 × 50 35 × 40	3.40 3.40
5600	22 × 35 25 × 30 30 × 25	1.95 1.95 2.00	22 × 50 25 × 40 30 × 35 35 × 30	2.75 2.70 2.75 2.75	30 × 45 35 × 35	3.20 3.20	35 × 45	3.80
6800	22 × 40 25 × 35 30 × 30 35 × 25	2.20 2.25 2.30 2.35	25 × 50 30 × 40 35 × 30	3.30 3.30 3.25	30 × 50 35 × 40	3.65 3.65	35 × 50	3.90
8200	22 × 50 25 × 40 30 × 30 35 × 25	2.55 2.50 2.75 2.75	30 × 45 35 × 35	3.60 3.55	35 × 45	3.90		
10000	22 × 45 30 × 35 35 × 30	2.85 2.90 2.95	30 × 50 35 × 40	4.50 4.00	35 × 50	4.40		
12000	25 × 50 30 × 40 35 × 30	3.25 3.25 3.15	35 × 45	4.55				
15000	30 × 45 35 × 35	3.70 3.65						
18000	35 × 40	4.35						
22000	35 × 50	4.90						

Note : *1. D × L : mm

*2. Ripple Current : (mA r.m.s 105°C / 120Hz)



CASE SIZE OF STANDARD PRODUCTS AND PERMISSIBLE RIPPLE CURRENT

CAP. (μF)	RATED VOLTAGE WV							
	100		160		180		200	
	Size	Ripple	Size	Ripple	Size	Ripple	Size	Ripple
150							22 × 20	0.65
180					22 × 20	0.75	22 × 20	0.70
220			22 × 20	0.80	22 × 25	0.85	22 × 25 25 × 20	0.80 0.80
270			22 × 25	1.00	22 × 25 25 × 20	0.95 0.90	22 × 25 25 × 25	0.85 0.85
330			22 × 25 25 × 20	1.20 1.15	22 × 25 22 × 30 25 × 25	1.20 1.10 1.10	22 × 30 25 × 25	1.20 1.20
390			22 × 30 25 × 25	1.30 1.30	22 × 30 25 × 25	1.30 1.30	22 × 30 22 × 35 25 × 30 30 × 25	1.30 1.30 1.30 1.30
470			22 × 30 25 × 25	1.30 1.40	22 × 30 22 × 35 25 × 30 30 × 25	1.30 1.35 1.40 1.40	22 × 35 22 × 40 25 × 30 30 × 25	1.40 1.40 1.40 1.50
560	22 × 25	1.05	22 × 40 25 × 30 30 × 25	1.50 1.50 1.50	22 × 40 25 × 35 30 × 25	1.50 1.55 1.50	22 × 45 25 × 35 30 × 30	1.55 1.55 1.55
680	22 × 25	1.20	22 × 45 25 × 35 30 × 25	1.70 1.70 1.70	22 × 45 22 × 50 25 × 35 25 × 40 30 × 30 35 × 25	1.70 1.70 1.70 1.75 1.70 1.70	22 × 50 25 × 40 30 × 30 35 × 25	1.75 1.75 1.75 1.70
820	22 × 30 25 × 25	1.30 1.33	22 × 50 25 × 40 30 × 30 35 × 25	1.95 2.00 2.00 1.90	22 × 50 25 × 40 25 × 45 30 × 35 35 × 25	1.95 2.00 2.00 2.00 1.90	25 × 50 30 × 35 35 × 30	2.05 2.00 2.05
1000	22 × 35 25 × 30	1.50 1.50	25 × 45 30 × 35 35 × 30	2.20 2.20 2.20	25 × 45 25 × 50 30 × 35 30 × 40 35 × 30	2.20 2.20 2.25 2.25 2.25	20 × 40 30 × 45 35 × 30 35 × 35	2.30 2.30 2.30 2.30
1200	22 × 40 25 × 35 30 × 25	1.70 1.70 1.70	25 × 50 30 × 40 35 × 30	2.45 2.45 2.45	25 × 50 30 × 40 30 × 45 35 × 35	2.45 2.45 2.50 2.50	30 × 50 35 × 40	2.60 2.65
1500	22 × 45 25 × 40 30 × 30 35 × 25	1.95 2.00 1.95 2.00	30 × 45 35 × 35	2.80 2.80	30 × 45 30 × 50 35 × 40	2.80 2.90 2.90	35 × 45	3.10
1800	25 × 45 30 × 35 35 × 30	2.20 2.50 2.45	30 × 50 35 × 45	3.30 3.30	30 × 50 35 × 50	3.30 3.30	35 × 50	3.15
2200	25 × 50 30 × 40 35 × 30	2.55 2.70 2.55	35 × 50	3.75	35 × 50	3.60		
2700	30 × 45 35 × 35	2.90 2.85						
3300	30 × 50 35 × 40	3.25 3.25						
3900	35 × 40	3.70						
4700	30 × 50 35 × 50	3.80 3.80						

Note : *1. D × L : mm

*2. Ripple Current : (mA r.m.s 105°C / 120Hz)



CASE SIZE OF STANDARD PRODUCTS AND PERMISSIBLE RIPPLE CURRENT

CAP. (μF)	RATED VOLTAGE WV							
	250		350		400		450	
	Size	Ripple	Size	Ripple	Size	Ripple	Size	Ripple
47					22 × 20	0.35		
56			22 × 20	0.40	22 × 20	0.40	22 × 25	0.40
68			22 × 25	0.45	22 × 25	0.50	22 × 30	0.50
					25 × 20	0.50	25 × 25	0.50
82			22 × 25	0.55	22 × 30	0.60	22 × 35	0.55
			25 × 20	0.50	25 × 25	0.65	25 × 30	0.55
							30 × 25	0.55
100			22 × 30	0.70	22 × 35	0.65	22 × 40	0.65
			25 × 25	0.70	25 × 30	0.65	25 × 30	0.60
120							30 × 25	0.65
	22 × 20	0.60	22 × 35	0.75	22 × 35	0.70	22 × 45	0.70
			25 × 30	0.75	25 × 30	0.70	25 × 35	0.70
			30 × 25	0.75	30 × 25	0.75	30 × 30	0.70
							35 × 25	0.70
150	22 × 25	0.65	22 × 40	0.80	22 × 40	0.80	22 × 50	0.80
			25 × 30	0.80	25 × 30	0.85	25 × 40	0.80
			30 × 25	0.85	25 × 35	0.85	30 × 30	0.75
					30 × 30	0.85	35 × 25	0.75
					35 × 25	0.80		
180	22 × 25	0.80	22 × 45	0.90	25 × 50	0.95	25 × 45	0.85
	25 × 20	0.75	25 × 35	0.90	25 × 40	0.95	30 × 35	0.85
			30 × 30	0.90	30 × 30	0.90	35 × 30	0.85
220	22 × 30	0.95	22 × 50	1.05	25 × 45	1.05	25 × 50	1.00
	25 × 25	0.95	25 × 40	1.05	30 × 35	1.05	30 × 40	1.00
			30 × 30	1.00	35 × 30	1.10	35 × 30	1.00
			35 × 25	1.05				
270	22 × 35	1.15	25 × 45	1.20	25 × 50	1.20	30 × 45	1.15
	25 × 30	1.15	30 × 35	1.20	30 × 40	1.20	35 × 35	1.15
	30 × 25	1.15	35 × 30	1.20	35 × 35	1.20		
330	22 × 40	1.25	30 × 40	1.35	30 × 45	1.40	30 × 50	1.40
	25 × 30	1.20	35 × 35	1.35	35 × 35	1.35	35 × 40	1.40
	30 × 25	1.25						
390	22 × 45	1.50	30 × 45	1.50	30 × 50	1.55	35 × 45	1.55
	25 × 35	1.50	35 × 35	1.50	35 × 40	1.55		
	30 × 30	1.50						
470	22 × 50	1.55	35 × 40	1.70	30 × 50	1.75	35 × 50	1.70
	25 × 40	1.55			35 × 45	1.75		
	30 × 30	1.55						
	35 × 25	1.55						
560	25 × 45	1.80	35 × 45	1.90	30 × 50	1.90		
	30 × 35	1.80			35 × 45	1.90		
	35 × 30	1.80						
680	25 × 50	1.95			35 × 50	2.15		
	30 × 40	2.00						
	35 × 35	2.00						
820	30 × 45	2.15						
	35 × 35	2.10						
1000	35 × 40	2.30						
1500	35 × 50	3.63						

Note : *1. D × L : mm

*2. Ripple Current : (mA r.m.s 105°C / 120Hz)

Miniature Size Aluminum Electrolytic Capacitors

LV [For 105°C, 3000 Hours General]

For Printed Circuit Board High-Performance Aluminum Electrolytic Power Supply Input and Output Filter Capacitors



DESCRIPTION (LG Series 105°C 2000 Hours Assured)

LV type capacitors are combined with snaplock terminals for easy to mount on P.C. Board.

Highly reliable capacitors that withstand under high ripple current. Two to Four dimensions with same ratings. Aluminum case designed explosion-proof vent.

Best for switching power supplies.

Multiplier for Ripple Current

Frequency coefficient

Frequency(Hz)	60	120	1K	10~50K
10~100V	0.9	1.0	1.15	1.25
160~250V	0.8	1.0	1.25	1.47
315~450V	0.8	1.0	1.30	1.47

Temperature coefficient

Temperature(°C)	20~45	65	85	105
Factor	2-10	1.89	1.52	1.0

DIAGRAM OF DIMENSIONS

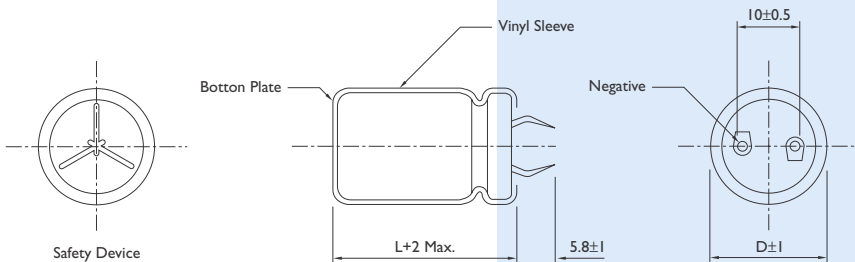

Location of P.C.B. Holes

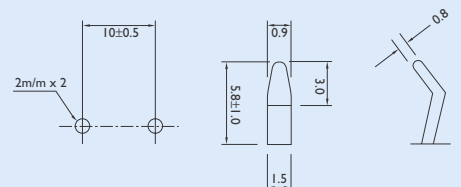

Unit : mm

ELECTRICAL CHARACTERISTICS

Operating Temperature Range	-40 to +105°C	-25 to +105°C																								
Rated Voltage Range	10 to 100VDC	160 to 450VDC																								
Nominal Capacitance Range	47 to 56000μF																									
Capacitance Tolerance	±20% (At 25°C, 120Hz)																									
Leakage Current	I = 3√CV (μA) after 5 minutes application of rated working voltage at +20°C																									
Dissipation Factor (tanδ)	<table border="1"> <thead> <tr> <th>Rate Voltage (V)</th> <th>10</th> <th>16</th> <th>25</th> <th>35</th> <th>50</th> <th>63</th> <th>80</th> <th>100</th> <th>160</th> <th>250</th> <th>315~450</th> </tr> </thead> <tbody> <tr> <td>D.F (%)</td> <td>55</td> <td>50</td> <td>45</td> <td>40</td> <td>35</td> <td>30</td> <td>25</td> <td>20</td> <td>15</td> <td>15</td> <td>25</td> </tr> </tbody> </table> <p>For capacitance value > 33000μF, add following calculated value : (rated capacitance) - 33000μF 10000μF × 0.1</p>		Rate Voltage (V)	10	16	25	35	50	63	80	100	160	250	315~450	D.F (%)	55	50	45	40	35	30	25	20	15	15	25
Rate Voltage (V)	10	16	25	35	50	63	80	100	160	250	315~450															
D.F (%)	55	50	45	40	35	30	25	20	15	15	25															
Low Temperature Characteristics (120Hz)	<table border="1"> <thead> <tr> <th>Rated Voltage (V)</th> <th>16~25</th> <th>35</th> <th>50</th> <th>63~100</th> <th>160</th> <th>450</th> </tr> </thead> <tbody> <tr> <td>Z(-25°C) / Z(20°C)</td> <td>6</td> <td>6</td> <td>4</td> <td>3</td> <td>8</td> <td>8</td> </tr> <tr> <td>Z(-40°C) / Z(20°C)</td> <td>15</td> <td>10</td> <td>8</td> <td>6</td> <td>-</td> <td>-</td> </tr> </tbody> </table>		Rated Voltage (V)	16~25	35	50	63~100	160	450	Z(-25°C) / Z(20°C)	6	6	4	3	8	8	Z(-40°C) / Z(20°C)	15	10	8	6	-	-			
Rated Voltage (V)	16~25	35	50	63~100	160	450																				
Z(-25°C) / Z(20°C)	6	6	4	3	8	8																				
Z(-40°C) / Z(20°C)	15	10	8	6	-	-																				
High Temperature Loading	Test conditions After 3000 hours application of rated voltage at +105°C the capacitor shall meet the following limits Post test requirements at +20°C Leakage current : ≤ Initial specified value Capacitance Change : within ±20% of the Initial measured value tan δ : ≤ 200% of initial specified value																									
Shelf Life	The following specifications shall be satisfied when the capacitor are restored to 25°C after exposing them for 1000 hours at 105°C without voltage applied. Capacitance Change : ≤ ±20% of the Initial Value D.F : ≤ 200% of the Initial Specified Value Leakage Current : ≤ 200% of Initial Specified Value																									



CASE SIZE OF STANDARD PRODUCTS AND PERMISSIBLE RIPPLE CURRENT

CAP. (μF)	RATED VOLTAGE WV											
	10		16		25		35		50		63	
	Size	Ripple	Size	Ripple	Size	Ripple	Size	Ripple	Size	Ripple	Size	Ripple
1000											20 × 25	1.10
1200											20 × 30	1.20
											22 × 25	1.20
1500									20 × 25	1.15	20 × 35	1.47
											22 × 30	1.47
1800									20 × 30	1.39	20 × 35	1.58
									22 × 25	1.34	22 × 30	1.58
											25 × 25	1.52
2200									20 × 35	1.60	20 × 40	1.80
									22 × 30	1.60	22 × 35	1.82
											25 × 30	1.75
2700							20 × 25	1.29	20 × 35	1.73	22 × 40	2.07
									22 × 30	1.70	25 × 35	2.11
									25 × 25	1.70	30 × 25	1.72
3300							20 × 30	1.57	20 × 40	1.97	22 × 45	2.33
							22 × 25	1.45	22 × 35	1.97	25 × 35	2.27
									25 × 30	1.88	30 × 30	2.24
3900					20 × 25	1.58	20 × 35	1.78	22 × 40	2.22	25 × 40	2.51
							22 × 30	1.69	25 × 30	2.20	30 × 35	2.55
									30 × 25	1.95		
4700					20 × 30	1.65	20 × 40	2.02	22 × 45	2.43	25 × 50	2.91
					22 × 25	1.61	22 × 35	2.02	25 × 35	2.43	30 × 40	2.86
							25 × 25	1.62	30 × 30	2.25	35 × 30	2.80
5600			20 × 25	1.68	20 × 35	1.85	22 × 35	2.13	22 × 50	2.75	30 × 40	3.22
					22 × 30	1.80	25 × 30	2.00	25 × 40	2.72	35 × 35	3.20
									30 × 30	2.64		
6800	20 × 25	1.31	20 × 30	1.80	20 × 40	2.11	22 × 40	2.41	25 × 45	3.30	30 × 50	3.65
			22 × 25	1.75	22 × 35	2.09	25 × 35	2.31	30 × 35	3.30	35 × 40	3.65
					25 × 25	1.87	30 × 25	2.31	35 × 30	3.25		
8200	20 × 30	1.59	20 × 35	2.08	22 × 40	2.31	22 × 50	2.85	30 × 40	3.60	35 × 45	4.04
			22 × 30	2.00	25 × 30	2.34	25 × 40	2.73	35 × 35	3.60		
					30 × 25	2.16	30 × 30	2.75				
10000	20 × 30	1.88	20 × 40	2.15	22 × 45	2.65	25 × 45	3.05	30 × 50	4.05	35 × 50	4.48
	22 × 25	1.77	22 × 30	2.10	25 × 35	2.61	30 × 35	3.05	35 × 40	4.04		
			25 × 25	2.05	30 × 30	2.61						
12000	20 × 35	2.18	22 × 35	2.31	22 × 50	2.80	25 × 50	3.37	35 × 45	4.56		
	22 × 30	2.10	25 × 30	2.30	25 × 40	2.81	30 × 40	3.23				
	25 × 25	1.94			30 × 30	2.74	35 × 30	3.19				
15000	20 × 40	2.27	22 × 40	2.68	25 × 45	3.27	30 × 45	3.72	35 × 50	4.77		
	22 × 35	2.23	25 × 35	2.58	30 × 35	3.13	35 × 35	3.67				
	25 × 30	2.10	30 × 25	2.30	35 × 30	3.26						
18000	22 × 40	2.41	22 × 50	3.20	30 × 40	3.56	35 × 40	4.37				
	25 × 30	2.34	25 × 40	3.16	35 × 35	3.84						
	30 × 25	2.25	30 × 30	2.57								
22000	22 × 45	2.58	25 × 45	3.36	30 × 45	4.04	35 × 45	4.92				
	25 × 35	2.54	30 × 30	2.98	35 × 35	3.75						
	30 × 30	2.50	35 × 30	3.25								
27000	22 × 50	3.17	25 × 50	3.85	35 × 45	4.74						
	25 × 40	3.07	30 × 35	3.30								
	30 × 30	2.95	35 × 35	3.93								
33000	25 × 45	3.39	30 × 40	3.80	35 × 50	5.50						
	30 × 35	3.33	35 × 35	4.27								
	35 × 30	3.21										
39000	30 × 40	3.70	30 × 45	4.30								
	35 × 35	3.68	35 × 40	4.80								
47000	30 × 45	4.22	30 × 50	4.81								
	35 × 40	4.16	35 × 45	5.53								
56000	35 × 50	5.00										

Note : *1. D × L : mm

*2. Ripple Current : (mA r.m.s 105°C / 120Hz)



CASE SIZE OF STANDARD PRODUCTS AND PERMISSIBLE RIPPLE CURRENT

CAP. (μF)	RATED VOLTAGE WV											
	80		100		160		180		200		220	
	Size	Ripple	Size	Ripple	Size	Ripple	Size	Ripple	Size	Ripple	Size	Ripple
180											20 × 25	0.81
220							20 × 25	0.81	20 × 25	0.83	20 × 30	0.94
											22 × 25	0.94
270					20 × 25	0.87	20 × 30	0.95	20 × 30	0.97	20 × 35	1.10
							22 × 25	0.97	22 × 25	0.99	22 × 30	1.09
330					20 × 30	1.02	20 × 35	1.09	20 × 35	1.17	20 × 40	1.18
					22 × 25	1.03	22 × 30	1.13	22 × 30	1.20	22 × 35	1.24
									25 × 25	1.20	25 × 25	1.14
390					20 × 35	1.15	20 × 35	1.28	20 × 40	1.27	20 × 45	1.33
					22 × 30	1.17	22 × 30	1.32	22 × 35	1.30	22 × 35	1.30
							25 × 25	1.33	25 × 30	1.34	25 × 25	1.26
470					20 × 40	1.25	22 × 40	1.34	22 × 40	1.44	22 × 40	1.41
					22 × 30	1.28	22 × 35	1.39	25 × 30	1.44	25 × 30	1.39
					25 × 25	1.29	25 × 30	1.43	30 × 25	1.48	30 × 25	1.37
560			20 × 25	0.95	22 × 35	1.45	22 × 40	1.56	22 × 45	1.60	22 × 45	1.60
					25 × 30	1.49	25 × 30	1.53	25 × 35	1.60	25 × 35	1.56
							30 × 25	1.56	30 × 30	1.60	30 × 30	1.61
											35 × 25	1.52
680			20 × 30	1.15	22 × 40	1.64	22 × 45	1.76	22 × 50	1.75	25 × 40	1.75
			22 × 25	1.09	25 × 35	1.70	25 × 35	1.76	25 × 40	1.76	30 × 35	1.76
					30 × 25	1.63	30 × 30	1.74	30 × 30	1.74	35 × 30	1.72
820	20 × 25	1.04	20 × 35	1.31	22 × 45	1.85	22 × 50	1.97	25 × 45	2.10	25 × 45	1.97
			22 × 30	1.32	25 × 40	1.92	25 × 40	1.99	30 × 35	2.11	30 × 40	2.06
					30 × 30	1.91	30 × 30	1.93	35 × 30	2.10	35 × 30	1.95
1000	20 × 30	1.24	20 × 35	1.43	25 × 45	2.17	25 × 45	2.24	25 × 50	2.36	30 × 45	2.44
	22 × 25	1.19	22 × 30	1.47	30 × 35	2.19	30 × 35	2.24	30 × 40	2.40	35 × 35	2.20
			25 × 25	1.45			35 × 30	2.20	35 × 35	2.30		
1200	20 × 35	1.43	20 × 40	1.61	25 × 50	2.43	30 × 40	2.53	30 × 45	2.69	35 × 40	2.37
	22 × 30	1.44	22 × 35	1.69	30 × 40	2.48	35 × 35	2.54	35 × 35	2.53		
			25 × 30	1.68	35 × 30	2.25						
1500	20 × 35	1.57	22 × 40	1.97	30 × 45	2.82	30 × 50	3.03	35 × 40	2.97	35 × 45	2.64
	22 × 30	1.59	25 × 35	1.98	35 × 35	2.62	35 × 40	2.91				
	25 × 25	1.59	30 × 25	1.95								
1800	20 × 40	1.77	22 × 45	2.23	30 × 50	3.13	35 × 45	3.25	35 × 45	3.45		
	22 × 35	1.79	25 × 40	2.20	35 × 40	2.97						
	25 × 30	1.71	30 × 30	2.20								
2200	22 × 40	2.03	25 × 45	2.53	35 × 45	3.34	35 × 50	3.62				
	25 × 35	1.98	30 × 35	2.55								
	30 × 25	1.98	35 × 30	2.50								
2700	22 × 45	2.39	25 × 50	2.82								
	25 × 40	2.35	30 × 40	2.86								
	30 × 30	2.35	35 × 35	2.89								
3300	25 × 45	2.64	30 × 45	3.30								
	30 × 35	2.61	35 × 35	3.25								
	35 × 30	2.47										
3900	25 × 50	2.92	30 × 50	3.60								
	30 × 40	2.82	35 × 40	3.67								
	35 × 30	2.97										
4700	30 × 45	3.34	35 × 45	3.80								
	35 × 35	3.38										
5600	30 × 50	3.80	35 × 50	4.05								
	35 × 40	3.80										
6800	35 × 45	3.90										
8200	35 × 50	4.20										

Note : *1. D × L : mm

*2. Ripple Current : (mA r.m.s 105°C / 120Hz)



CASE SIZE OF STANDARD PRODUCTS AND PERMISSIBLE RIPPLE CURRENT

CAP. (μF)	RATED VOLTAGE WV													
	250		315		350		385		400		420		450	
	Size	Ripple	Size	Ripple	Size	Ripple	Size	Ripple	Size	Ripple	Size	Ripple	Size	Ripple
47													20 × 25	0.36
56							20 × 25	0.37	20 × 25	0.40	20 × 25	0.40	20 × 30	0.41
							22 × 25	0.42					22 × 25	0.42
68					20 × 25	0.41	20 × 30	0.44	20 × 30	0.48	20 × 30	0.48	20 × 35	0.47
							22 × 25	0.45	22 × 25	0.49	22 × 25	0.50	22 × 30	0.50
													25 × 25	0.50
82			20 × 25	0.39	20 × 30	0.45	20 × 30	0.50	20 × 30	0.54	20 × 35	0.53	20 × 40	0.53
							22 × 30	0.52	22 × 30	0.56	22 × 30	0.56	22 × 35	0.56
											25 × 25	0.56	25 × 30	0.57
100			20 × 30	0.45	20 × 30	0.51	20 × 35	0.56	20 × 35	0.60	20 × 35	0.58	22 × 40	0.64
					22 × 25	0.53	22 × 30	0.58	22 × 30	0.62	22 × 30	0.63	25 × 30	0.63
							25 × 25	0.57	25 × 25	0.61	25 × 25	0.63	30 × 25	0.67
120			20 × 30	0.54	20 × 35	0.59	20 × 40	0.66	20 × 40	0.71	20 × 45	0.71	22 × 45	0.72
			22 × 25	0.56	22 × 30	0.61	22 × 35	0.68	22 × 35	0.73	22 × 35	0.73	25 × 35	0.71
					25 × 25	0.62	25 × 30	0.68	25 × 30	0.73	25 × 30	0.72	30 × 30	0.77
											30 × 25	0.75		
150	20 × 25	0.71	20 × 35	0.64	20 × 40	0.70	22 × 40	0.79	22 × 40	0.85	22 × 45	0.86	22 × 50	0.80
			22 × 30	0.66	22 × 35	0.73	25 × 30	0.78	25 × 35	0.85	25 × 35	0.83	25 × 40	0.82
			25 × 25	0.65	25 × 30	0.73	30 × 25	0.75	30 × 25	0.79	30 × 25	0.83	30 × 30	0.85
180	20 × 30	0.82	20 × 40	0.75	22 × 40	0.83	22 × 45	0.89	22 × 45	0.95	22 × 50	1.02	25 × 45	0.93
	22 × 25	0.84	22 × 35	0.78	25 × 30	0.80	25 × 35	0.86	25 × 35	0.92	25 × 40	0.94	30 × 35	0.97
			25 × 30	0.71	30 × 25	0.81	30 × 30	0.88	30 × 30	0.95	30 × 30	0.95		
											35 × 25	0.90		
220	20 × 35	0.95	22 × 40	0.89	22 × 45	0.94	22 × 50	1.01	22 × 50	1.08	25 × 45	1.13	25 × 50	1.05
	22 × 30	0.97	25 × 30	0.85	25 × 35	0.92	25 × 40	1.00	25 × 40	1.05	30 × 35	1.09	30 × 40	1.10
	25 × 25	0.99	30 × 25	0.83	30 × 30	0.98	30 × 30	1.00	30 × 35	1.24	35 × 30	1.05	35 × 30	1.01
270	20 × 40	1.08	22 × 45	1.01	22 × 50	1.07	25 × 45	1.13	25 × 50	1.29	25 × 50	1.37	30 × 45	1.25
	22 × 35	1.11	25 × 35	0.98	25 × 40	1.05	30 × 40	1.14	30 × 40	1.30	30 × 40	1.25	35 × 35	1.26
	25 × 30	1.15	30 × 30	1.01	30 × 30	1.03	35 × 30	1.10	35 × 30	1.18	35 × 35	1.25		
330	22 × 40	1.26	22 × 50	1.14	25 × 45	1.24	30 × 45	1.31	30 × 45	1.47	30 × 45	1.49	30 × 50	1.42
	25 × 30	1.26	25 × 40	1.12	30 × 35	1.24	35 × 35	1.32	35 × 35	1.41	35 × 35	1.42	35 × 40	1.44
	30 × 25	1.31	30 × 35	1.21	35 × 30	1.18								
390	22 × 45	1.41	25 × 45	1.31	25 × 50	1.38	30 × 50	1.48	30 × 50	1.64	30 × 50	1.67	35 × 45	1.61
	25 × 35	1.42	30 × 35	1.30	30 × 40	1.39	35 × 40	1.48	35 × 40	1.59	35 × 40	1.61		
	30 × 30	1.50	35 × 30	1.23	35 × 35	1.39								
470	22 × 50	1.58	30 × 40	1.53	30 × 45	1.57	35 × 45	1.76	35 × 45	1.87	35 × 45	1.86	35 × 45	1.80
	25 × 40	1.61	35 × 35	1.47	35 × 35	1.50								
	30 × 30	1.61												
560	25 × 45	1.80	30 × 45	1.65	30 × 50	1.75	35 × 50	1.95	35 × 50	2.09				
	30 × 35	1.84	35 × 40	1.66	35 × 40	1.69								
680	25 × 50	2.03	35 × 45	1.96	35 × 45	1.96								
	30 × 40	2.09												
	35 × 30	1.96												
820	30 × 45	2.35	35 × 50	2.19										
	35 × 35	2.26												
1000	30 × 50	2.64												
	35 × 40	2.57												
1200	30 × 45	2.88												

Note : *1. D × L : mm

*2. Ripple Current : (mA r.m.s 105°C / 120Hz)

Surface Mount Aluminum Electrolytic

CA Series

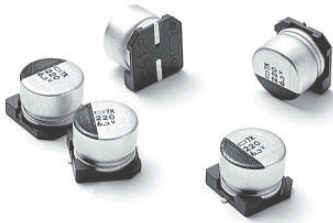

FEATURE

For General Purposes Series with 85°C 2000 Hours

Suitable for AV (TV, Video, Audio), Personal Computer, Home Appliance

MARKING

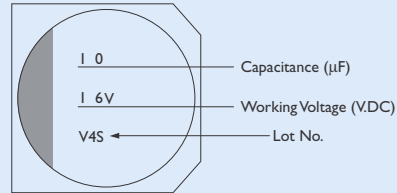

DIMENSIONS

Unit : mm

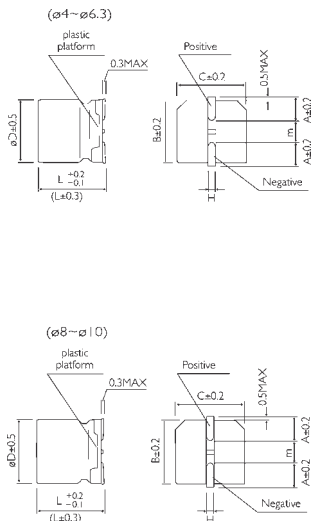

SIZE CODE	DØ	L	A	H	I	W	P	K
B	4.0	5.4	4.3	5.5 Max.	1.8	0.65 ± 0.1	1.0	0.35 $\begin{smallmatrix} +0.15 \\ -0.20 \end{smallmatrix}$
C	5.0	5.4	5.3	6.5 Max.	2.2	0.65 ± 0.1	1.5	0.35 $\begin{smallmatrix} +0.15 \\ -0.20 \end{smallmatrix}$
D	6.3	5.4	6.6	7.8 Max.	2.6	0.65 ± 0.1	2.2	0.35 $\begin{smallmatrix} +0.15 \\ -0.20 \end{smallmatrix}$
E	8.0	6.5	8.3	9.4 Max.	3.4	0.65 ± 0.1	2.2	0.35 $\begin{smallmatrix} +0.15 \\ -0.20 \end{smallmatrix}$
F	8.0	10.5	8.3	10.0 Max.	3.4	0.90 ± 0.2	3.1	0.70 ± 0.20
G	10.0	10.5	10.3	12.0 Max.	3.5	0.90 ± 0.2	4.6	0.70 ± 0.20
H	6.3	7.7	6.6	0.8 Max.	2.6	0.65 ± 0.1	2.2	0.35 $\begin{smallmatrix} +0.15 \\ -0.20 \end{smallmatrix}$

Surface Mount Aluminum Electrolytic

CB Series

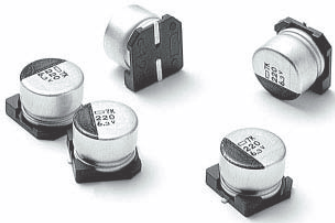

FEATURE

For General Purposes Series with 105°C 1000 Hours

Suitable for AV (TV, Video, Audio), Personal Computer, Home Appliance

MARKING

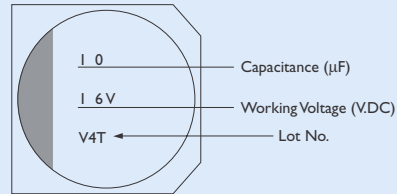

DIMENSIONS

Unit : mm

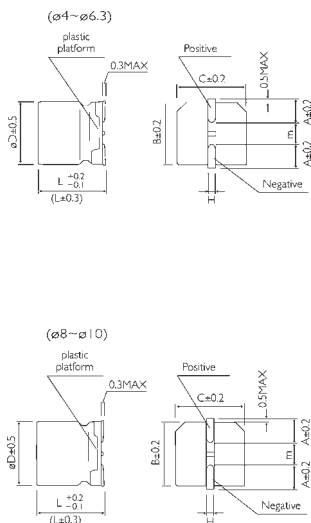

SIZE CODE	DØ	L	A	H	I	W	P	K
B	4.0	5.4	4.3	5.5 Max.	1.8	0.65 ± 0.1	1.0	0.35 ^{+0.15} _{-0.20}
C	5.0	5.4	5.3	6.5 Max.	2.2	0.65 ± 0.1	1.5	0.35 ^{+0.15} _{-0.20}
D	6.3	5.4	6.6	7.8 Max.	2.6	0.65 ± 0.1	2.2	0.35 ^{+0.15} _{-0.20}
E	8.0	6.5	8.3	9.5 Max.	3.4	0.65 ± 0.1	2.2	0.35 ^{+0.15} _{-0.20}
F	8.0	10.5	8.3	10.0 Max.	3.4	0.90 ± 0.2	3.1	0.70 ± 0.20
G	10.0	10.5	10.3	12.0 Max.	3.5	0.90 ± 0.2	4.6	0.70 ± 0.20
H	6.3	7.7	6.6	0.8 Max.	2.6	0.65 ± 0.1	2.2	0.35 ^{+0.15} _{-0.20}



SPECIFICATION

ITEM	CHARACTERISTIC																								
Operation Temperature Range	-40 to +105°C																								
Rated Working Voltage Range	4 to 50V. DC																								
Rated Capacitance	Range = 0.1 ~ 1000μF																								
Capacitance Tolerance	±20% (120Hz / +25°C)																								
Leakage Current (25°C)	Polarized : $I \leq 0.01CV$ or 3 (μA) Whichever is greater after 2 minutes application of DC rated working voltage at 25°C. I : Leakage Current (μA) C : Rated Capacitance (μF) V : Working Voltage (V)																								
Dissipation Factor (tanδ) (120Hz / +25°C)	Polarized () : D.F. of Downsized <table border="1"> <thead> <tr> <th>WV (V)</th> <th>4</th> <th>6.3</th> <th>10</th> <th>16</th> <th>25</th> <th>35</th> <th>50</th> </tr> </thead> <tbody> <tr> <td>D.F.</td> <td>35</td> <td>28</td> <td>24</td> <td>20</td> <td>16</td> <td>14</td> <td>12</td> </tr> </tbody> </table>	WV (V)	4	6.3	10	16	25	35	50	D.F.	35	28	24	20	16	14	12								
WV (V)	4	6.3	10	16	25	35	50																		
D.F.	35	28	24	20	16	14	12																		
Low Temperature Stability	Impedance Ratio at 120Hz <table border="1"> <thead> <tr> <th>WV (V)</th> <th>4</th> <th>6.3</th> <th>10</th> <th>16</th> <th>25</th> <th>35</th> <th>50</th> </tr> </thead> <tbody> <tr> <td>Z(-25°C)/Z(+20°C)</td> <td>7</td> <td>4</td> <td>3</td> <td>2</td> <td>2</td> <td>2</td> <td>2</td> </tr> <tr> <td>Z(-40°C)/Z(+20°C)</td> <td>15</td> <td>8</td> <td>6</td> <td>4</td> <td>4</td> <td>3</td> <td>3</td> </tr> </tbody> </table>	WV (V)	4	6.3	10	16	25	35	50	Z(-25°C)/Z(+20°C)	7	4	3	2	2	2	2	Z(-40°C)/Z(+20°C)	15	8	6	4	4	3	3
WV (V)	4	6.3	10	16	25	35	50																		
Z(-25°C)/Z(+20°C)	7	4	3	2	2	2	2																		
Z(-40°C)/Z(+20°C)	15	8	6	4	4	3	3																		
Load Life	After 1000 hours application of WV at 105°C, the capacitor shall meet following limits. Capacitance Change ≤ ±20% of Initial Value Dissipation Factor ≤ 200% of Initial Specified Value Leakage Current ≤ Initial Specified Value																								
Shelf Life	At +105°C no voltage application after 1000 hours and then through the aging treatment, the capacitor shall meet limits for load life characteristics.																								

CASE SIZE & MAX RIPPLE CURRENT

Max. Ripple Current (mA) r.m.s. (120Hz / +85°C)

POLARIZED

μF	4	6.3	10	16	25	35	50
0.1							4 × 5.4 0.7
0.22							4 × 5.4 1.6
0.33							4 × 5.4 2.5
0.47							4 × 5.4 3.5
1.0							4 × 5.4 4
2.2							4 × 5.4 11
3.3						4 × 5.4 13	4 × 5.4 13
4.7					4 × 5.4 13	4 × 5.4 14	5 × 5.4 16
10					4 × 5.4 13	4 × 5.4 21	6.3 × 5.4 24
				4 × 5.4 18	5 × 5.4 20		
22		4 × 5.4 22	4 × 5.4 22	4 × 5.4 18	6.3 × 5.4 36	5 × 5.4 38	6.3 × 7.7 51
			4 × 5.4 25	5 × 5.4 37			
33	4 × 5.4 18	5 × 5.4 27	5 × 5.4 30	6.3 × 5.4 40	6.3 × 5.4 44	6.3 × 5.4 42	6.3 × 7.7 60
47	4 × 5.4 23	5 × 5.4 33	6.3 × 5.4 41	6.3 × 5.4 48	6.3 × 5.4 48	6.3 × 7.7 49	6.3 × 7.7 63
100	5 × 5.4 42	6.3 × 5.4 50	6.3 × 5.4 53	6.3 × 5.4 60	6.3 × 7.7 91	8 × 10.5 155	8 × 10.5 155
150	6.3 × 5.4 61	6.3 × 5.4 55	6.3 × 5.4 62	6.3 × 7.7 95	8 × 10.5 140	8 × 10.5 155	10 × 10.5 300
220	6.3 × 5.4 68	6.3 × 7.7 105	6.3 × 7.7 105	6.3 × 7.7 105	8 × 10.5 175	10 × 10.5 300	
330	6.3 × 7.7 73	6.3 × 7.7 105	8 × 10.5 175	8 × 10.5 195	10.5 × 10.5 220		
470	6.3 × 7.7 105	8 × 10.5 170	8 × 10.5 210	8 × 10.5 310			
680	8 × 10.5 210	8 × 10.5 210	10 × 10.5 230	10 × 10.5 350			
1000	8 × 10.5 260	10 × 10.5 230					