

## Aluminum Capacitors Solid Al, Radial Pearl Miniature

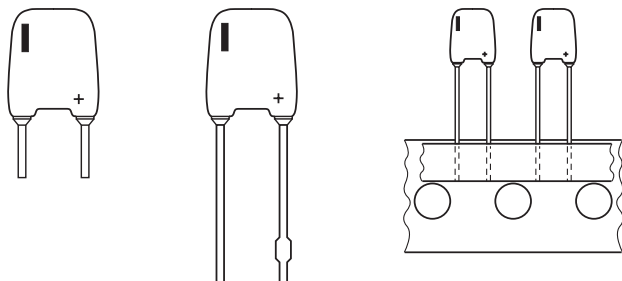
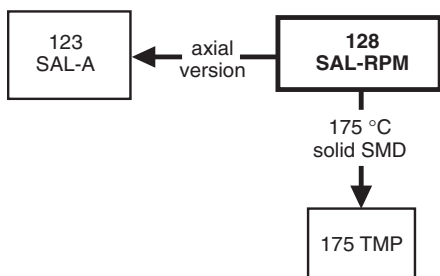

Fig.1 Component outlines.



### FEATURES

- Polarized aluminum electrolytic capacitors, solid electrolyte MnO<sub>2</sub>
- Radial leads, max. height 10 mm, resin dipped, orange coloured
- Extremely long useful life, 20000 hours/125 °C
- Extended usable temperature range up to 175 °C
- Excellent low temperature, impedance and ESR behaviour
- Charge and discharge proof, application with 0 Ω resistance allowed
- Reverse DC voltage up to 0.3 × U<sub>R</sub> allowed
- AC voltage up to 0.8 × U<sub>R</sub> allowed
- Advanced technology to achieve high reliability and high stability.



**RoHS\***  
COMPLIANT

### APPLICATIONS

- EDP, telecommunication, general industrial, automotive and audio-video
- Smoothing, filtering and buffering
- For small power supplies, DC/DC converters.

### MARKING

The capacitors are marked (where possible) with the following information:

- Rated capacitance (in μF).
- Tolerance on rated capacitance, code letter in accordance with IEC 60062 (M for ± 20 %).
- Rated voltage (in V) and category voltage if applicable.
- Date code in accordance with IEC60062.
- Name of manufacturer.
- 'I' sign to indicate the negative terminal.
- '+' sign to identify the positive terminal.
- Series Number.

### MOUNTING

When bending, cutting or straightening the leads, ensure that the capacitor body is relieved of stress.

Bending after soldering must be avoided.

QUICK REFERENCE DATA	
DESCRIPTION	VALUE
Maximum case sizes (H × W × T in mm)	10 × 7 × 3 to 10 × 8 × 6
Rated capacitance range (E6 series), C <sub>R</sub>	0.1 to 68 μF
Tolerance on C <sub>R</sub>	± 20 %
Rated voltage range, U <sub>R</sub>	6.3 to 40 V
Category temperature range:	
U <sub>R</sub> = 6.3 to 40 V	- 55 to + 85 °C
U <sub>C</sub> = 6.3 to 25 V	- 55 to + 125 °C
Endurance test at 125 °C	10000 hours
Useful life at 125 °C	20000 hours
Useful life at 175 °C	2000 hours
Useful life at 40 °C, I <sub>R</sub> applied	> 300000 hours
Shelf life at 0 V, 125 °C	500 hours
Based on sectional specification	IEC 60384-4/EN130300
Climatic category IEC 60068	55/125/56

\*Pb containing terminations are not RoHS compliant, exemptions may apply

<b>SELECTION CHART FOR <math>C_R</math>, <math>U_R</math>, <math>U_C</math> AND RELEVANT MAXIMUM CASE SIZES (H x W x T in mm)</b>						
$C_R$ ( $\mu\text{F}$ )	$U_R$ (V) at $T_{\text{amb}} = 85^\circ\text{C}$					
	6.3	10	16	25	35	40
	$U_C$ (V) at $T_{\text{amb}} = 125^\circ\text{C}$					
	6.3	10	16	25	25	25
0.1	-	-	-	-	-	10 x 7 x 3
0.15	-	-	-	-	-	10 x 7 x 3
0.22	-	-	-	-	-	10 x 7 x 3.5
0.33	-	-	-	-	10 x 7 x 3.5	10 x 7 x 4
0.47	-	-	-	-	10 x 7 x 4	10 x 7 x 5
0.68	-	-	-	10 x 7 x 3.5	10 x 7 x 4	10 x 7 x 5
1	-	-	-	10 x 7 x 3.5	10 x 7 x 5	10 x 8 x 5
1.5	-	-	-	10 x 7 x 3.5	10 x 8 x 5	10 x 8 x 6
2.2	-	-	10 x 7 x 3.5	10 x 7 x 4	10 x 8 x 6	10 x 8 x 6
3.3	-	-	10 x 7 x 3.5	10 x 7 x 5	10 x 8 x 6	-
4.7	-	10 x 7 x 3.5	10 x 7 x 4	10 x 8 x 5	-	-
6.8	-	10 x 7 x 3.5	10 x 7 x 4	10 x 8 x 6	-	-
10	10 x 7 x 3.5	10 x 7 x 4	10 x 7 x 5	10 x 8 x 6	-	-
15	-	10 x 7 x 4	10 x 8 x 5	-	-	-
22	10 x 7 x 4	10 x 7 x 5	10 x 8 x 6	-	-	-
33	10 x 7 x 5	10 x 8 x 5	-	-	-	-
47	10 x 8 x 5	10 x 8 x 6	-	-	-	-
68	10 x 8 x 6	-	-	-	-	-

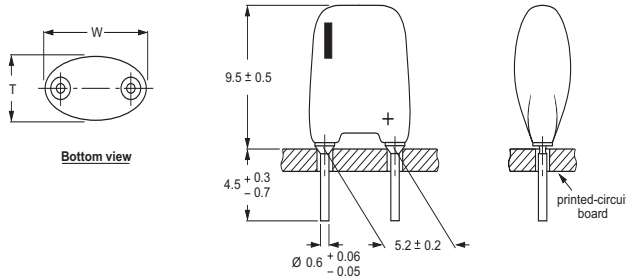
**DIMENSIONS in millimeters AND AVAILABLE FORMS**

The diameter of the mounting holes in the printed-circuit board is  $0.8 \pm 0.1$  mm.  
Flanges are provided with degassing grooves.

Fig.2 Form CB: Short leads, in boxes.

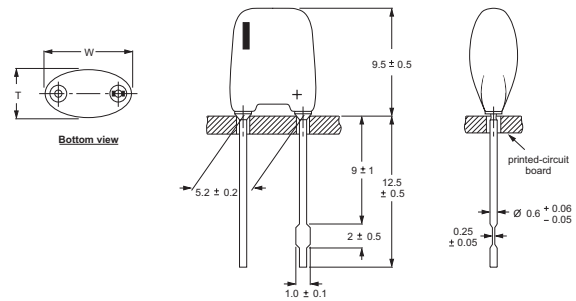

The diameter of the mounting holes in the printed-circuit board is  $0.8 \pm 0.1$  mm, except for the hole of the anode lead of Form CA capacitors:  $1.3 - 0.2$  mm.  
Flanges are provided with degassing grooves.

Fig.3 Form CA: Long leads with keyed polarity, in boxes.

Table 1

<b>DIMENSIONS in millimeters, MASS AND PACKAGING QUANTITIES</b>						
MAXIMUM CASE SIZE $H \times W \times T$ (mm)	CASE CODE	MASS (g)	PACKAGING QUANTITIES			
			FORM CA (note 1)	FORM CB (note 1)	FORM TR+	FORM TFA
10 x 7 x 3	10	≈ 0.22	1000	1000	2000	1000
10 x 7 x 3.5	20	≈ 0.25	1000	1000	2000	1000
10 x 7 x 4	30	≈ 0.30	1000	1000	2000	1000
10 x 7 x 5	40	≈ 0.35	1000	1000	1000	1000
10 x 8 x 5	50	≈ 0.50	1000	1000	1000	1000
10 x 8 x 6	60	≈ 0.60	1000	1000	1000	1000

**Note**

- In plastic bags of 200 units each.
- Detailed tape dimensions see section 'PACKAGING'.



## TAPED PRODUCTS

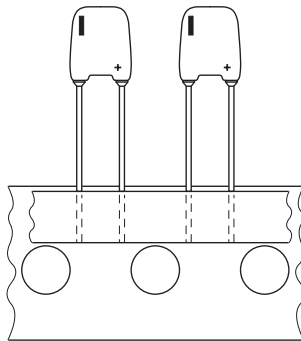

Form TR+: Taped on reel, positive leading.  
Form TFA: Taped in ammpack.

Fig.4 Taped versions.

ELECTRICAL DATA	
$C_R$	rated capacitance at 100 Hz, tolerance $\pm 20\%$
$I_R$	max. RMS ripple current no necessary DC applied
$I_{L5}$	max. leakage current after 5 minutes at $U_R$
Tan $\delta$	max. dissipation factor at 100 Hz; note 1
ESR	max./typ. equivalent series resistance at 100 Hz
Z	max. impedance at 100 kHz

### Note

- Unless otherwise specified, all electrical values in Table 2 apply at  $T_{amb} = 20$  to  $25^\circ\text{C}$ ,  $P = 86$  to  $106$  kPa,  $RH = 45$  to  $75\%$ .

### ORDERING EXAMPLE

Electrolytic capacitors 128 series  $10\ \mu\text{F}/16\ \text{V}; \pm 20\%$   
Maximum case size:  $10 \times 7 \times 5\ \text{mm}$ ; Form CB;  
Lead (Pb)-Free

Catalog number: 2281 128 55109

Table 2

ELECTRICAL DATA AND ORDERING INFORMATION																	
$U_C$ (V)	$U_R$ (V)	$C_R$ 100 Hz ( $\mu\text{F}$ )	MAXIMUM CASE SIZE H x W x T (mm)	CASE CODE	$I_R$ 100 Hz 125 °C (mA)	$I_R$ 10 kHz 85 °C (mA)	$I_R$ 100 kHz 40 °C (mA)	$I_{L5}$ 5 min ( $\mu\text{A}$ )	MAX. ESR 100 Hz ( $\Omega$ )	TYP. ESR 100 Hz ( $\Omega$ )	Z 100 kHz ( $\Omega$ )	CATALOG NUMBER 2281 128..... LEAD (Pb)-FREE <sup>2</sup>					
												FORM CB	FORM CA	FORM TR+ REEL	FORM TFA AMMO		
6.3	6.3	10	$10 \times 7 \times 3.5$	20	22.4	320	595	2	20	8	2.0	53109	73109	23109	33109		
		22	$10 \times 7 \times 4$	30	32.9	470	870	4	9	3.5	1.0	53229	73229	23229	33229		
		33	$10 \times 7 \times 5$	40	65.4	595	1100	5	6.1	2	0.70	53339	73339	23339	33339		
		47	$10 \times 8 \times 5$	50	118.4	740	1360	7	4.3	2	0.50	53479	73479	23479	33479		
		68	$10 \times 8 \times 6$	60	153.0	800	1650	11	3.0	1.5	0.40	53689	73689	23689	33689		
10	10	4.7	$10 \times 7 \times 3.5$	20	16.1	230	425	2	43	16	3.00	54478	74478	24478	34478		
		6.8	$10 \times 7 \times 3.5$	20	18.9	270	500	2	30	12	2.20	54688	74688	24688	34688		
		10	$10 \times 7 \times 4$	30	21.7	310	573	3	20	9	1.70	54109	74109	24109	34109		
		15	$10 \times 7 \times 4$	30	27.3	390	720	4	14	7	1.20	54159	74159	24159	34159		
		22	$10 \times 7 \times 5$	40	51.7	470	870	6	9	3.5	0.90	54229	74229	24229	34229		
		33	$10 \times 8 \times 5$	50	81.6	510	940	8	6.1	2	0.60	54339	74339	24339	34339		
		47	$10 \times 8 \times 6$	60	105.4	620	1140	12	4.3	1.5	0.40	54479	74479	24479	34479		
16	16	2.2	$10 \times 7 \times 3.5$	20	14.0	200	370	2	91	25	4.50	55228	75228	25228	35228		
		3.3	$10 \times 7 \times 3.5$	20	16.1	230	425	2	61	26	3.30	55338	75338	25338	35338		
		4.7	$10 \times 7 \times 4$	30	18.9	270	500	2	43	14	2.30	55478	75478	25478	35478		
		6.8	$10 \times 7 \times 4$	30	22.4	320	590	3	30	11	1.65	55688	75688	25688	35688		
		10	$10 \times 7 \times 5$	40	42.9	390	720	4	20	6	1.10	55109	75109	25109	35109		
		15	$10 \times 8 \times 5$	50	71.2	445	820	6	14	5	0.85	55159	75159	25159	35159		
		22	$10 \times 8 \times 6$	60	86.7	510	940	9	9	3.5	0.65	55229	75229	25229	35229		
25	25	0.68	$10 \times 7 \times 3.5$	20	7.7	110	200	2	295	85	17.00	56687	76687	26687	36687		
		1	$10 \times 7 \times 3.5$	20	9.1	130	240	2	200	71	12.50	56108	76108	26108	36108		
		1.5	$10 \times 7 \times 3.5$	20	10.8	155	285	2	135	48	10.00	56158	76158	26158	36158		
		2.2	$10 \times 7 \times 4$	30	13.6	195	360	2	91	34	7.00	56228	76228	26228	36228		
		3.3	$10 \times 7 \times 5$	40	16.1	230	425	2	61	19	5.20	56338	76338	26338	36338		
		4.7	$10 \times 8 \times 5$	50	25.3	270	500	3	43	14	3.50	56478	76478	26478	36478		
		6.8	$10 \times 8 \times 6$	60	52.7	310	570	4	30	11	2.70	56688	76688	26688	36688		
		10	$10 \times 8 \times 6$	60	64.8	360	660	6	20	9	2.00	56109	76109	26109	36109		
		25	35	0.33	$10 \times 7 \times 3.5$	20	5.6	80	145	2	610	185	27.00	50337	70337	20337	30337
0.47	$10 \times 7 \times 4$			30	6.3	90	165	2	430	130	20.00	50477	70477	20477	30477		
0.68	$10 \times 7 \times 4$			30	7.7	110	205	2	295	89	15.00	50687	70687	20687	30687		
1	$10 \times 7 \times 5$			40	13.7	125	230	2	200	49	10.00	50108	70108	20108	30108		
1.5	$10 \times 8 \times 5$			50	24.8	155	285	2	135	41	7.00	50158	70158	20158	30158		
2.2	$10 \times 8 \times 6$			60	33.1	195	360	2	91	28	4.50	50228	70228	20228	30228		
3.3	$10 \times 8 \times 6$			60	39.9	235	435	3	61	28	3.50	50338	70338	20338	30338		
25	40			0.1	$10 \times 7 \times 3$	10	2.0	40	75	2	1990	950	45.00	57107	77107	27107	37107
				0.15	$10 \times 7 \times 3$	10	2.5	50	95	2	1330	400	35.00	57157	77157	27157	37157
		0.22	$10 \times 7 \times 3.5$	20	4.2	60	115	2	910	275	27.00	57227	77227	27227	37227		
		0.33	$10 \times 7 \times 4$	30	5.3	75	140	2	610	172	20.00	57337	77337	27337	37337		
		0.47	$10 \times 7 \times 5$	40	10.4	95	175	2	430	114	15.00	57477	77477	27477	37477		
		0.68	$10 \times 7 \times 5$	40	12.1	110	205	2	295	89	10.00	57687	77687	27687	37687		
		1	$10 \times 8 \times 5$	50	20.0	125	230	2	200	45	7.00	57108	77108	27108	37108		
		1.5	$10 \times 8 \times 6$	60	25.5	150	280	2	135	35	5.50	57158	77158	27158	37158		
		2.2	$10 \times 8 \times 6$	60	33.1	195	360	2	91	28	4.20	57228	77228	27228	37228		

### Note

- Tan  $\delta$  at 100 Hz for all types  $< 0.10$ .
- Non Lead (Pb)-free version available on request.



ADDITIONAL ELECTRICAL DATA		
PARAMETER	CONDITIONS	VALUE
<b>Voltage</b>		
Surge voltage		$U_S \leq 1.15 \times U_R$
Reverse voltage		$U_{rev} < 0.3 \times U_R$
Maximum peak AC voltage	reverse voltage applied	$\leq 2 V$
Maximum peak AC voltage, without reverse voltage applied	$T_{amb} \leq 85\text{ }^\circ\text{C}$ : at $f \leq 0.1\text{ Hz}$ at $0.1\text{ Hz} < f \leq 1\text{ Hz}$ at $1\text{ Hz} < f \leq 10\text{ Hz}$ at $10\text{ Hz} < f \leq 50\text{ Hz}$ at $f > 50\text{ Hz}$ $85\text{ }^\circ\text{C} < T_{amb} \leq 125\text{ }^\circ\text{C}$ : at $f \leq 0.1\text{ Hz}$ at $0.1\text{ Hz} < f \leq 1\text{ Hz}$ at $1\text{ Hz} < f \leq 10\text{ Hz}$ at $10\text{ Hz} < f \leq 50\text{ Hz}$ at $f > 50\text{ Hz}$	$0.30 \times U_R$ $0.45 \times U_R$ $0.60 \times U_R$ $0.65 \times U_R$ $0.80 \times U_R$  $0.15 \times U_R$ $0.22 \times U_R$ $0.30 \times U_R$ $0.32 \times U_R$ $0.40 \times U_R$
<b>Inductance</b>		
Equivalent series inductance (ESL)	case sizes $10 \times 7 \times 3$ to $10 \times 7 \times 5\text{ mm}$	typ. 9 to 14 nH
	case sizes $10 \times 8 \times 5$ and $10 \times 8 \times 6\text{ mm}$	typ. 11 to 16 nH
	all case sizes	max. 20 nH
<b>Dissipation</b>		
Maximum power dissipation	case sizes $10 \times 7 \times 3$ to $10 \times 7 \times 5\text{ mm}$	$P_{125} = 88\text{ mW}$
	case sizes $10 \times 8 \times 5$ and $10 \times 8 \times 6\text{ mm}$	$P_{125} = 104\text{ mW}$
<b>Current</b>		
Maximum leakage current	after 5 minutes at $U_R$ and $T_{amb} = 25\text{ }^\circ\text{C}$	$I_{L5} \leq 0.025 C_R \times U_R$ or $2\text{ }\mu\text{A}$ whichever is greater; see Table 2
Typical leakage current	15 s at $U_R$ and $T_{amb} = 25\text{ }^\circ\text{C}$ : $U_R = 6.3$ to $16\text{ V}$ $U_R = 25$ to $40\text{ V}$	$\approx 0.2 \times$ value stated in Table 2 $\approx 0.1 \times$ value stated in Table 2

**VOLTAGE**

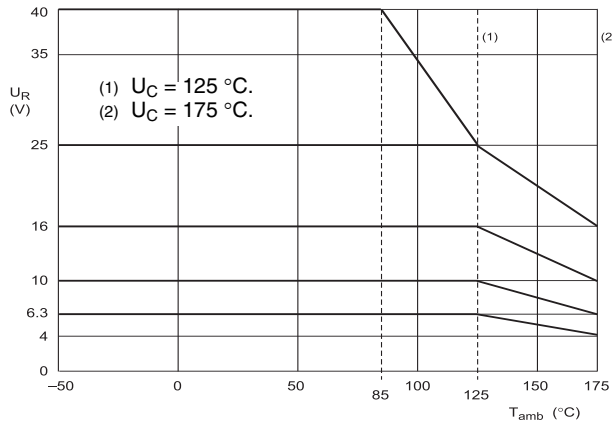

Fig.5 Maximum permissible voltage up to  $T_{amb} = 175\text{ }^\circ\text{C}$ .

**RIPPLE CURRENT ( $I_R$ )**

PARAMETER	$T_{amb}$					
	25 °C	40 °C	65 °C	85 °C	105 °C	125 °C
$I_R$ multiplier	1.1	1.0	0.88	0.75	0.59	0.37

**Note**

1. Applying the maximum RMS ripple current given in Table 2 will cause a device temperature of 138 °C
2. The 100 kHz values in Table 2 for other temperatures are to be calculated with the above  $I_R$  multipliers:

**CAPACITANCE (C)**

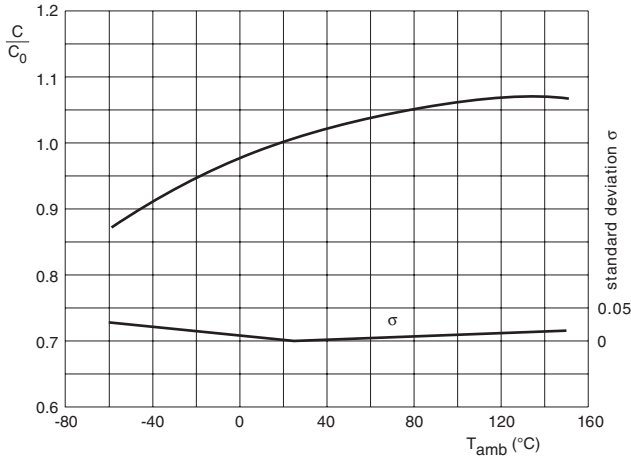

$C_0$  = capacitance at 25 °C and 100 Hz.

Fig.6 Typical multiplier of capacitance and standard deviation as functions of ambient temperature.

**TYPICAL CAPACITANCE CHANGE AFTER ENDURANCE TEST AT  $T_{AMB} = 125$  °C**

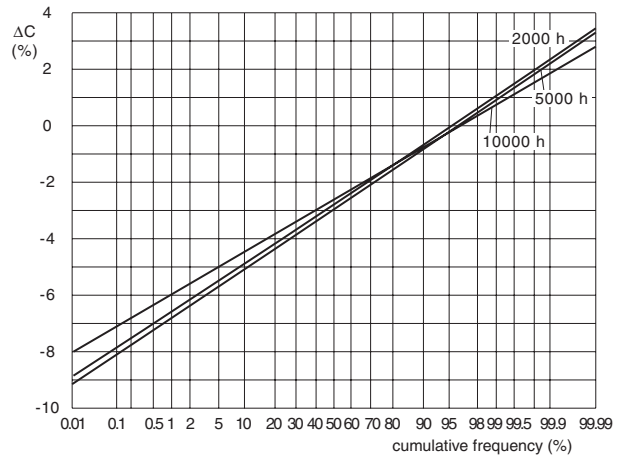
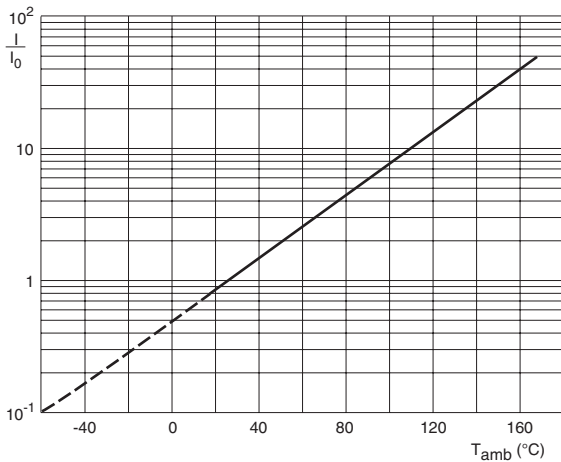

Fig.7 Change of capacitance as a function of cumulative frequency after endurance test.

**LEAKAGE CURRENT**



$I_0$  = leakage current during continuous operation at  $U_R$  and  $T_{amb} = 25$  °C.

Fig.8 Typical multiplier of leakage current as a function of ambient temperature.

**TYPICAL LEAKAGE CURRENT CHANGE AFTER ENDURANCE TEST AT  $T_{AMB} = 125$  °C**

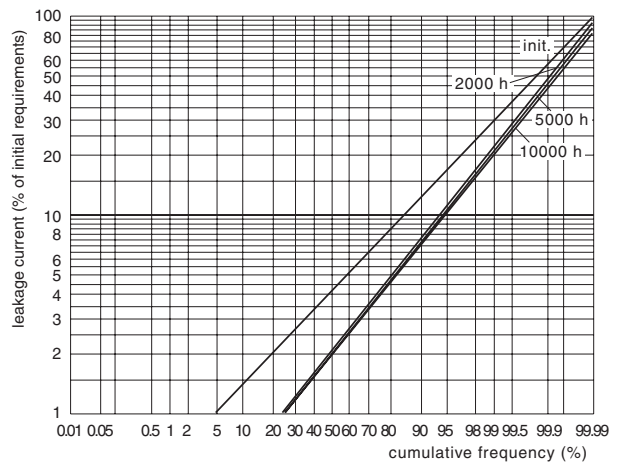
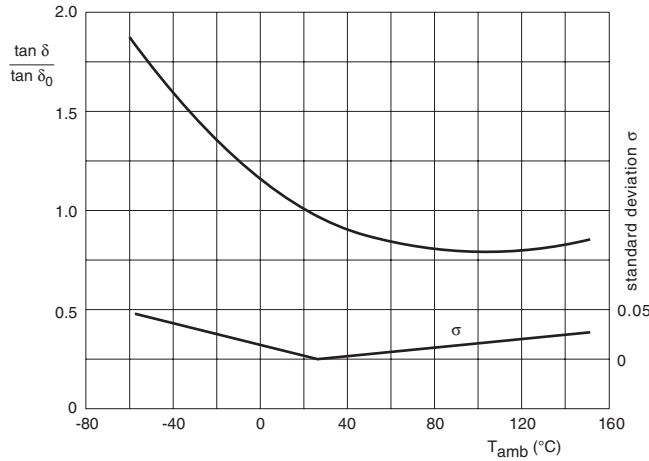

Fig.9 Leakage current change as a function of cumulative frequency after endurance test.

**DISSIPATION FACTOR ( $\tan \delta$ )**



$\tan \delta_0$  = dissipation factor at  $T_{amb} = 25^{\circ}\text{C}$  and 100 Hz.

Fig.10 Typical multiplier of dissipation factor and standard deviation as functions of ambient temperature.

**TYPICAL  $\tan \delta$  CHANGE AFTER ENDURANCE TEST AT  $T_{AMB} = 125^{\circ}\text{C}$**

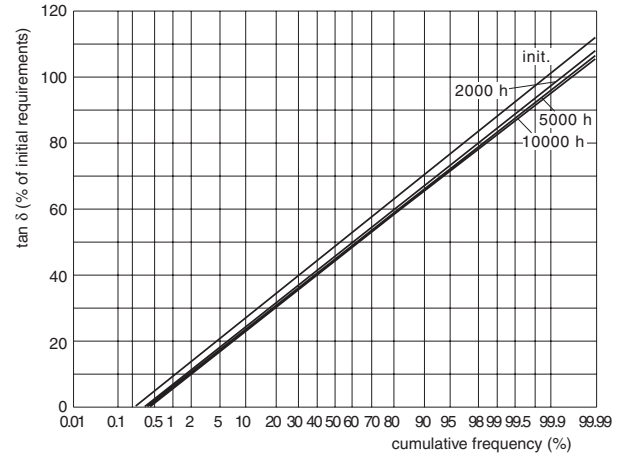
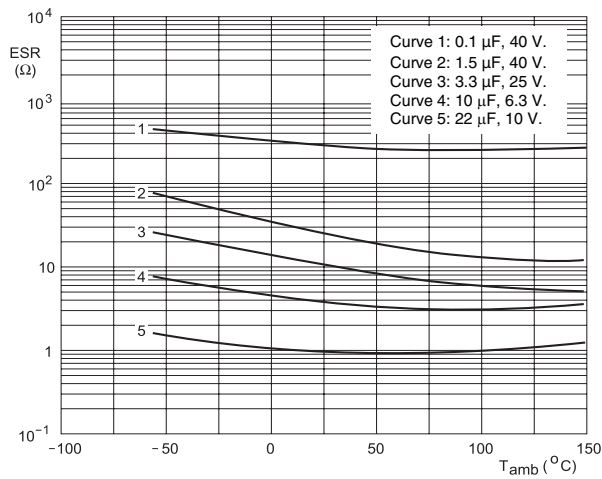

Fig.11  $\tan \delta$  change as a function of cumulative frequency after endurance test.

**EQUIVALENT SERIES RESISTANCE (ESR)**



ESR at 100 Hz.  
Fig.12 Typical ESR as a function of ambient temperature.

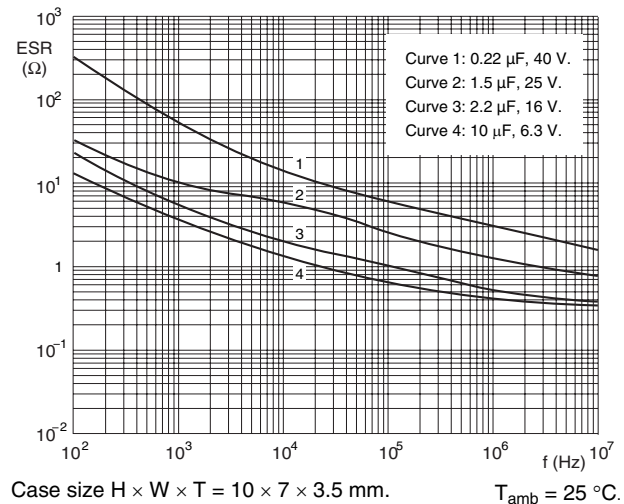
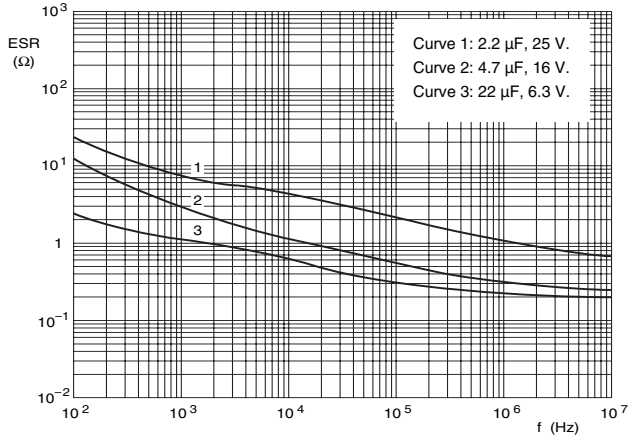

Fig.13 Typical ESR as a function of frequency.

**EQUIVALENT SERIES RESISTANCE (ESR)**



Case size H × W × T = 10 × 7 × 4 mm. T<sub>amb</sub> = 25 °C.

Fig.14 Typical ESR as a function of frequency.

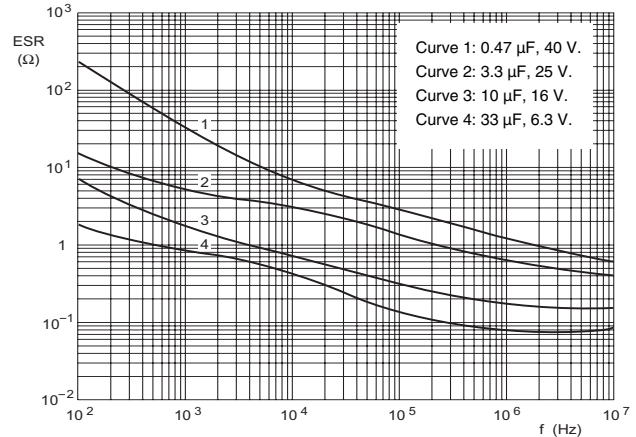

Case size H × W × T = 10 × 7 × 5 mm. T<sub>amb</sub> = 25 °C.

Fig.15 Typical ESR as a function of frequency.

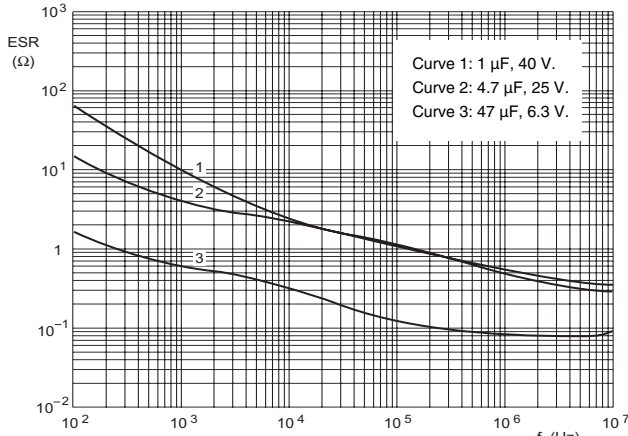

Case size H × W × T = 10 × 8 × 5 mm. T<sub>amb</sub> = 25 °C.

Fig.16 Typical ESR as a function of frequency.

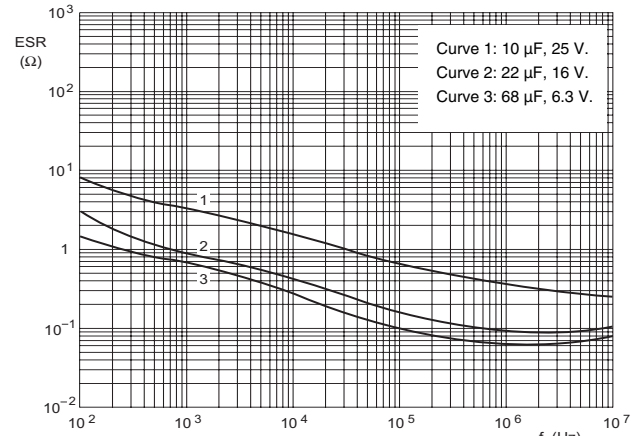

Case size H × W × T = 10 × 8 × 6 mm. T<sub>amb</sub> = 25 °C.

Fig.17 Typical ESR as a function of frequency.

**IMPEDANCE (Z)**

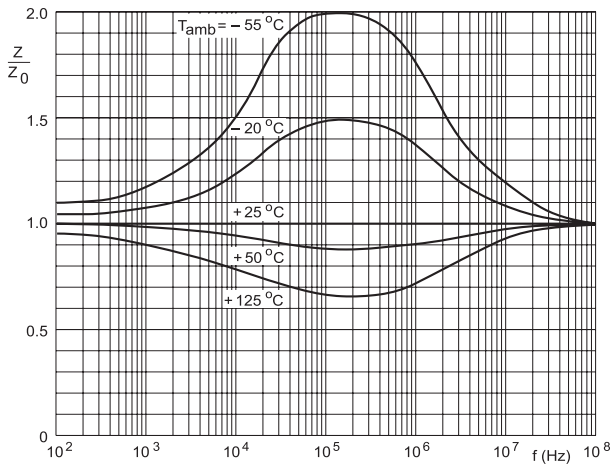

Z<sub>0</sub> = initial impedance value at T<sub>amb</sub> = 25 °C.

Fig.18 Typical multiplier of impedance as a function of frequency at different ambient temperatures.

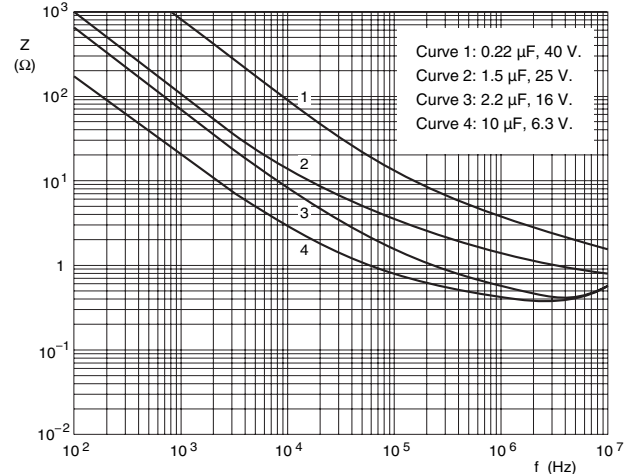

Case size H × W × T = 10 × 7 × 3.5 mm. T<sub>amb</sub> = 25 °C.

Fig.19 Typical impedance as a function of frequency.



**IMPEDANCE (Z)**

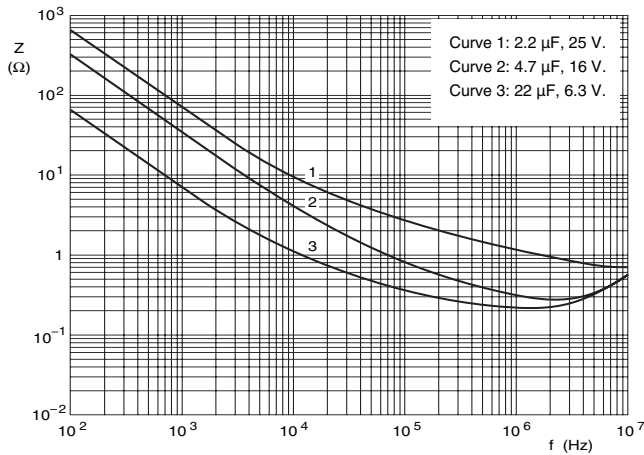

Case size H × W × T = 10 × 7 × 4 mm      T<sub>amb</sub> = 25 °C.

Fig.20 Typical impedance as a function of frequency.

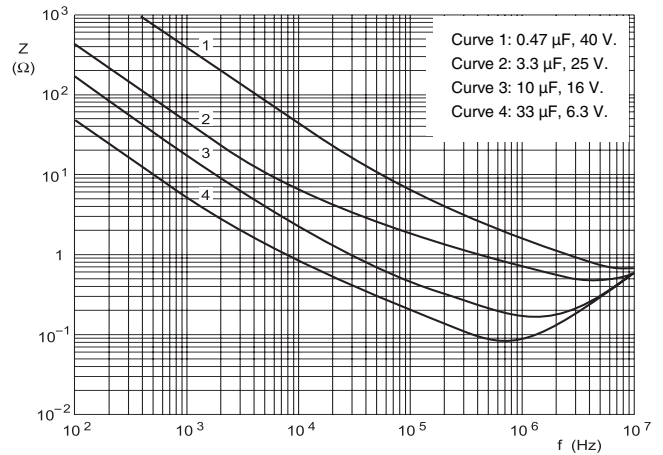

Case size H × W × T = 10 × 7 × 5 mm.      T<sub>amb</sub> = 25 °C.

Fig.21 Typical impedance as a function of frequency.

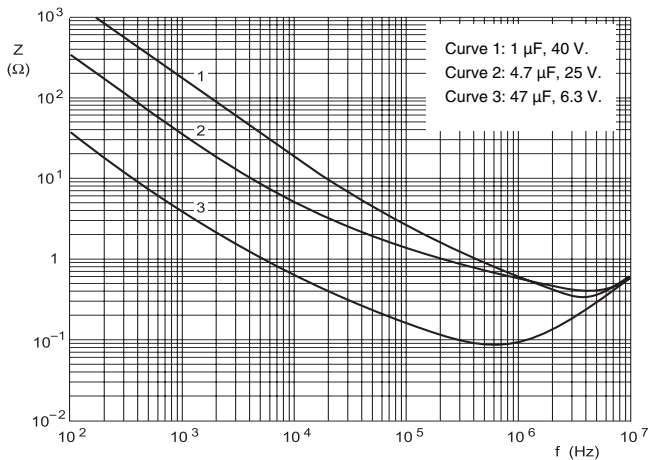

Case size H × W × T = 10 × 8 × 5 mm.      T<sub>amb</sub> = 25 °C.

Fig.22 Typical impedance as a function of frequency.

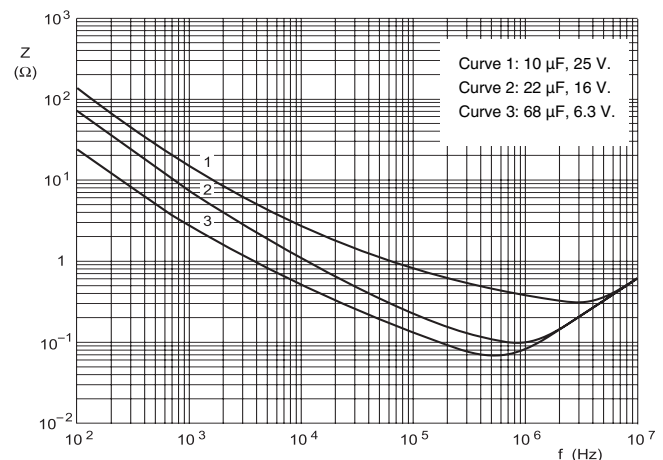

Case size H × W × T = 10 × 8 × 6 mm.      T<sub>amb</sub> = 25 °C.

Fig.23 Typical impedance as a function of frequency.



Table 3

<b>TEST PROCEDURES AND REQUIREMENTS</b>			
<b>TEST</b>		<b>PROCEDURE (quick reference)</b>	<b>REQUIREMENTS</b>
<b>NAME OF TEST</b>	<b>REFERENCE</b>		
Endurance	IEC 60384-4/ EN130300 subclause 4.13	$T_{amb} = 125\text{ }^{\circ}\text{C}$ ; $U_R = 6.3$ to $25\text{ V}$ with $U_R$ applied; $U_R = 35$ and $40\text{ V}$ with $U_C$ applied; 10000 hours	$\Delta C/C: \pm 10\%$ $\tan \delta \leq 1.2 \times \text{spec. limit}$ $Z \leq 1.2 \times \text{spec. limit}$ $I_L 5 \leq \text{spec. limit}$
Useful life	CECC 30302 subclause 1.8.1	$T_{amb} = 125\text{ }^{\circ}\text{C}$ ; $I_R$ applied and: $U_R = 6.3$ to $25\text{ V}$ with $U_R$ applied; $U_R = 35$ and $40\text{ V}$ with $U_C$ applied; 20000 hours	$\Delta C/C: \pm 15\%$ $\tan \delta \leq 1.5 \times \text{spec. limit}$ $Z \leq 1.5 \times \text{spec. limit}$ $I_L 5 \leq \text{spec. limit}$ no short or open circuit, no visible damage total failure percentage: $< 1\%$
Shelf life (storage at high temperature)	IEC 60384-4/ EN130300 subclause 4.17	$T_{amb} = 125\text{ }^{\circ}\text{C}$ ; no voltage applied; 500 hours	$\Delta C/C: \pm 10\%$ $\tan \delta \leq 1.2 \times \text{spec. limit}$ $I_L 5 \leq 1 \times \text{spec. limit}$
Charge and discharge	IEC 60384-4-2 subclause 9.21	$10^6$ cycles without series resistance: 0.5 s to $U_R$ ; 0.5 s to ground	$\Delta C/C: \pm 5\%$ no short or open circuit, no visible damage
Solvent resistance	IEC 60068-2-45, test XA IEC 60653	immersion: $5 \pm 0.5$ minutes with or without ultrasonic at $55 \pm 5\text{ }^{\circ}\text{C}$ solvents: demineralized water and/or calgonite solution (20 g/l)	visual appearance not affected
Extended vibration	IEC 60068-2-6 test Fc	10 to 2000 Hz; 1.5 mm or 20 g; 1 octave/minute; 3 directions; 1 sweep per direction; no voltage applied	no intermittent contacts no breakdown no open circuiting no mechanical damage $\Delta C/C: \pm 5\%$ $\tan \delta \leq 1.2 \times \text{spec. limit}$ $Z \leq 1.2 \times \text{spec. limit}$ $I_L 5 \leq 1.5 \times \text{spec. limit}$
Shock	IEC 60068-2-27 test Ea	half-sine or sawtooth pulse shape; 50 g; 11 ms; 3 successive shocks in each direction of 3 mutually perpendicular axes; no voltage applied	no intermittent contacts no breakdown no open circuiting no mechanical damage $\Delta C/C: \pm 5\%$ $\tan \delta \leq 1.2 \times \text{spec. limit}$ $Z \leq 1.2 \times \text{spec. limit}$ $I_L 5 \leq 1.5 \times \text{spec. limit}$
Passive flammability	IEC 60695-2-2	capacitor mounted to a vertical printed-circuit board, one flame on capacitor body; $T_{amb} = 20$ to $25\text{ }^{\circ}\text{C}$ ; test duration = 20 s	after removing the test flame from the capacitor, the capacitor must not continue to burn for more than 15 s; no burning particles must drop from the sample



## Notice

Specifications of the products displayed herein are subject to change without notice. Vishay Intertechnology, Inc., or anyone on its behalf, assumes no responsibility or liability for any errors or inaccuracies.

Information contained herein is intended to provide a product description only. No license, express or implied, by estoppel or otherwise, to any intellectual property rights is granted by this document. Except as provided in Vishay's terms and conditions of sale for such products, Vishay assumes no liability whatsoever, and disclaims any express or implied warranty, relating to sale and/or use of Vishay products including liability or warranties relating to fitness for a particular purpose, merchantability, or infringement of any patent, copyright, or other intellectual property right.

The products shown herein are not designed for use in medical, life-saving, or life-sustaining applications. Customers using or selling these products for use in such applications do so at their own risk and agree to fully indemnify Vishay for any damages resulting from such improper use or sale.