

Aluminum Capacitors Power Long Life Snap-in

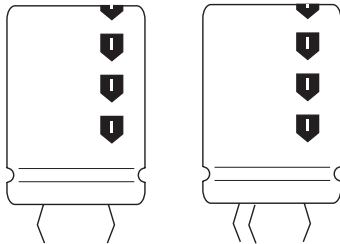
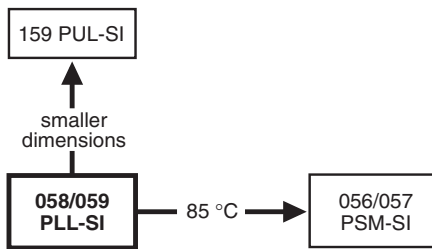

Fig.1 Component outlines.



FEATURES

- Polarized aluminum electrolytic capacitors, non-solid electrolyte
- Large types, minimized dimensions, cylindrical aluminum case, insulated with a blue sleeve
- Very long useful life: up to 10000 hours at 105 °C
- Extended temperature range: 105 °C
- Low ESR, high ripple current capability
- Keyed polarity version available
- Lead (Pb)-free versions are RoHS compliant.



APPLICATIONS

- Computer, telecommunication and industrial systems
- Smoothing and filtering applications
- Standard and switched mode power supplies
- Energy storage in pulse systems.

MARKING

The capacitors are marked (where possible) with the following information:

- Rated capacitance (in μF).
- Tolerance code on rated capacitance, code letter in accordance with IEC 60062 (M for $\pm 20\%$).
- Rated voltage (in V).
- Date code (YYMM).
- Name of manufacturer.
- Code for factory of origin.
- '-' sign to identify the negative terminal, visible from the top and side of the capacitor.
- Code number.
- Climatic category in accordance with IEC 60068.

QUICK REFERENCE DATA		
DESCRIPTION	VALUE	
	058	059
Nominal case sizes ($\varnothing D \times L$ in mm)	22 \times 25 to 35 \times 50	
Rated capacitance range (E6 series), C_R	33 to 47000 μF	
Tolerance on C_R	$\pm 20\%$	
Rated voltage range, U_R	10 to 100 V	200 to 400 V
Category temperature range	-40 to +105 °C	
Endurance test at 105 °C	≤ 50 V: 2000 hours; ≥ 63 V: 5000 hours	
Useful life at 105 °C	≤ 50 V: 5000 hours; ≥ 63 V: 10000 hours	
Useful life at 40 °C, $1.9 \times I_R$ applied	≤ 50 V: 125000 hours; ≥ 63 V: 250000 hours	
Shelf life at 0 V, 105 °C	500 hours	
Based on sectional specification	IEC 60384-4/EN130300	
Climatic category IEC 60068	40/105/56	

SELECTION CHART FOR C_R , U_R AND RELEVANT NOMINAL CASE SIZES FOR 058 SERIES ($\varnothing D \times L$ in mm)							
C_R (∞F)	U_R (V)						
	10	16	25	40	50	63	100
330	-	-	-	-	-	-	22 \times 25
470	-	-	-	-	-	-	22 \times 30
680	-	-	-	-	-	22 \times 25	25 \times 30
	-	-	-	-	-	-	22 \times 40
1000	-	-	-	-	22 \times 25	22 \times 30	30 \times 30
	-	-	-	-	-	-	25 \times 40
1500	-	-	-	22 \times 25	22 \times 30	25 \times 30	30 \times 40
	-	-	-	-	-	22 \times 40	25 \times 50

* Pb containing terminations are not RoHS compliant, exemptions may apply



SELECTION CHART FOR C_R , U_R AND RELEVANT NOMINAL CASE SIZES FOR 058 SERIES ($\varnothing D \times L$ in mm)							
C_R (∞F)	U_R (V)						
	10	16	25	40	50	63	100
2200	-	-	22 x 25	22 x 30	25 x 30	30 x 30	35 x 40
	-	-	-	-	22 x 40	25 x 40	30 x 50
3300	-	22 x 25	22 x 30	25 x 30	30 x 30	30 x 40	35 x 50
	-	-	-	22 x 40	25 x 40	25 x 50	-
4700	22 x 25	22 x 30	25 x 30	30 x 30	30 x 40	35 x 40	-
	-	-	22 x 40	25 x 40	25 x 50	30 x 50	-
6800	22 x 30	25 x 30	30 x 30	30 x 40	35 x 40	35 x 50	-
	-	22 x 40	25 x 40	25 x 50	30 x 50	-	-
10000	25 x 30	30 x 30	30 x 40	35 x 40	35 x 50	-	-
	22 x 40	25 x 40	25 x 50	30 x 50	-	-	-
15000	30 x 30	30 x 40	35 x 40	35 x 50	-	-	-
	25 x 40	25 x 50	30 x 50	-	-	-	-
22000	30 x 40	35 x 40	35 x 50	-	-	-	-
	25 x 50	30 x 50	-	-	-	-	-
33000	35 x 40	35 x 50	-	-	-	-	-
	30 x 50	-	-	-	-	-	-
47000	35 x 50	-	-	-	-	-	-

SELECTION CHART FOR C_R , U_R AND RELEVANT NOMINAL CASE SIZES FOR 059 SERIES ($\varnothing D \times L$ in mm)				
C_R (∞F)	U_R (V)			
	200	250	385	400
33	-	-	22 x 25	-
47	-	-	22 x 30	22 x 30
68	-	22 x 25	22 x 35	22 x 35
	-	-	25 x 30	25 x 30
100	22 x 25	22 x 30	30 x 30	30 x 30
	-	-	25 x 40	25 x 40
150	22 x 30	22 x 35	25 x 50	30 x 35
	-	25 x 30	30 x 40	25 x 50
220	22 x 35	30 x 30	35 x 40	35 x 40
	25 x 30	25 x 35	30 x 50	30 x 50
330	30 x 30	30 x 35	35 x 50	35 x 50
	25 x 40	25 x 50	-	-
470	30 x 35	35 x 35	-	-
	25 x 50	30 x 45	-	-
680	35 x 35	35 x 45	-	-
	30 x 45	-	-	-
1000	35 x 50	-	-	-

DIMENSIONS in millimeters **AND AVAILABLE FORMS**

TWO TERMINAL SNAP-IN

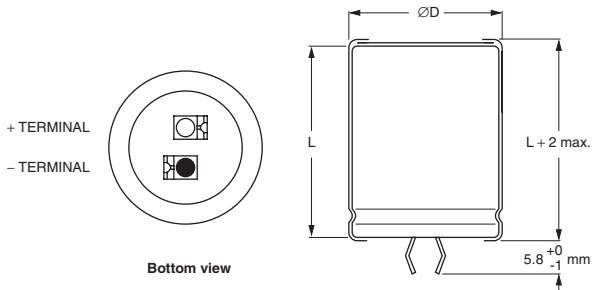

The minus terminal can be marked with a black dot or with an

Fig.2 Two terminal snap-in.

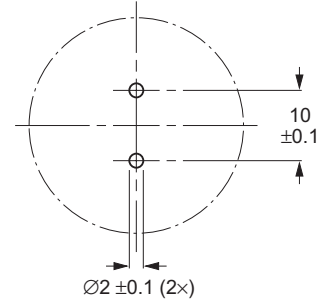
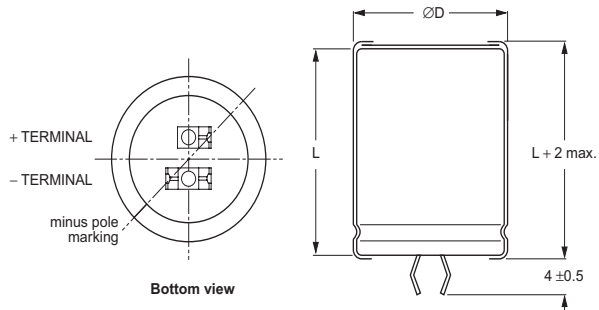

Fig.3 Mounting hole diagram.

THREE TERMINAL SNAP-IN



The negative terminal has **TWO** pins which are **BOTH**

Fig.4 Three terminal snap-in.

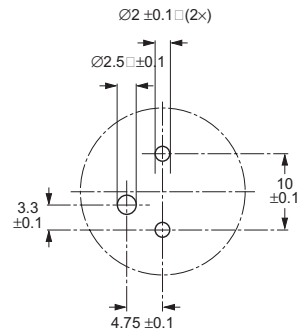

The 10 mm spacing of the 2 pin snap-in is used as the base layout and a third hole is added.

The third hole is closer to the negative primary hole so

Fig.5 Mounting hole diagram.

Table 1

DIMENSIONS in millimeters, MASS AND PACKAGING QUANTITIES					
NOMINAL CASE SIZE ØD × L	ØDmax	Lmax	MASS (g)	PACKAGING QUANTITIES (units per box)	CARDBOARD BOX DIMENSIONS L × W × H
22 × 25	23	27	≈12	100	260 × 250 × 39
22 × 30	23	32	≈16	100	260 × 250 × 44
22 × 35	23	37	≈20	100	260 × 250 × 49
22 × 40	23	42	≈23	100	260 × 250 × 54
25 × 30	26	32	≈22	100	290 × 280 × 44
25 × 35	26	37	≈24	100	290 × 280 × 49
25 × 40	26	42	≈27	100	290 × 280 × 54
25 × 50	26	52	≈38	100	290 × 280 × 64
30 × 30	31	32	≈30	100	340 × 330 × 44
30 × 35	31	37	≈35	100	340 × 330 × 49
30 × 40	31	42	≈40	100	340 × 330 × 54
30 × 45	31	47	≈45	100	340 × 330 × 59
30 × 50	31	52	≈50	100	340 × 330 × 64
35 × 35	36	37	≈48	50	390 × 198 × 49
35 × 40	36	42	≈55	50	390 × 198 × 54
35 × 45	36	47	≈63	50	390 × 198 × 59
35 × 50	36	52	≈72	50	390 × 198 × 64



Aluminum Capacitors
Power Long Life Snap-in

Vishay BCcomponents

ELECTRICAL DATA	
SYMBOL	DESCRIPTION
C _R	rated capacitance at 100 Hz
I _R	rated RMS ripple current at 100 Hz or ≥ 10 kHz and 105 °C
I _{L1}	max. leakage current after 1 minute at U _R
I _{L5}	max. leakage current after 5 minutes at U _R
ESR	max. equivalent series resistance at 100 Hz
Z	max. impedance at 10 kHz

ORDERING EXAMPLE*

Electrolytic capacitor 058 series
 10000 μF/25 V; ±20%
 Nominal case size: Ø30 × 40 mm
 2-terminal snap-in:
 Catalog number: 2222 058 56103.
 3-terminal snap-in:
 Catalog number: 2222 058 76103.

Note

1. Unless otherwise specified, all electrical values in Tables 2 and 3 apply at T_{amb} = 20 °C, P = 86 to 106 kPa, RH = 45 to 75%.

*Note: To ensure delivery of lead (Pb)-free parts during the transition period, please contact your Vishay sales agent.

Table 2

ELECTRICAL DATA AND ORDERING INFORMATION FOR 058 SERIES											
U _R (V)	C _R 100 Hz (μF)	NOMINAL CASE SIZE ØD × L (mm)	I _R 100 Hz 105 °C (A)	I _R ≥10 kHz 105 °C (A)	I _{L1} 1 min (μA)	I _{L5} 5 min (μA)	ESR 100 Hz (mΩ)	Z 10 Hz (mΩ)	CATALOG NUMBER 2222 058		
									2-TERM.	3-TERM.	
10	4700	22 × 25	1.95	2.30	286	98	82	57	54472	74472	
	6800	22 × 30	2.44	2.88	412	140	61	44	54682	74682	
	10000	25 × 30	2.81	3.32	604	204	54	42	54103	74103	
	10000	22 × 40	3.29	3.88	604	204	43	32	44103	24103	
	15000	30 × 30	3.53	4.17	904	304	42	34	54153	74153	
	15000	25 × 40	3.78	4.46	904	304	38	30	44153	24153	
	22000	30 × 40	4.62	5.45	1324	444	31	25	54223	74223	
	22000	25 × 50	4.68	5.52	1324	444	31	24	44223	24223	
	33000	35 × 40	5.15	6.08	1984	664	30	24	54333	74333	
	33000	30 × 50	5.70	6.73	1984	664	24	21	44333	24333	
	47000	35 × 50	6.23	7.35	2824	944	24	21	54473	74473	
	16	3300	22 × 25	1.90	2.24	321	110	86	57	55332	75332
		4700	22 × 30	2.36	2.78	455	154	65	44	55472	75472
6800		25 × 30	2.75	3.25	657	222	56	42	55682	75682	
6800		22 × 40	3.18	3.75	657	222	46	32	45682	25682	
10000		30 × 30	3.44	4.06	964	324	44	34	55103	75103	
10000		25 × 40	3.66	4.32	964	324	40	30	45103	25103	
15000		30 × 40	4.55	5.37	1444	484	32	25	55153	75153	
15000		25 × 50	4.55	5.37	1444	484	32	24	45153	25153	
22000		35 × 40	5.07	5.98	2116	708	31	24	55223	75223	
22000		30 × 50	5.67	6.69	2116	708	25	21	45223	25223	
33000		35 × 50	6.23	7.35	3172	1060	25	21	55333	75333	
25		2200	22 × 25	1.76	2.08	334	114	100	57	56222	76222
		3300	22 × 30	2.23	2.63	499	169	73	44	56332	76332
	4700	25 × 30	2.60	3.07	709	239	62	42	56472	76472	
	4700	22 × 40	3.00	3.54	709	239	52	32	46472	26472	
	6800	30 × 30	3.26	3.85	1024	344	49	34	56682	76682	
	6800	25 × 40	3.49	4.12	1024	344	44	30	46682	26682	
	10000	30 × 40	4.37	5.16	1504	504	35	25	56103	76103	
	10000	25 × 50	4.37	5.16	1504	504	35	24	46103	26103	
	15000	35 × 40	4.91	5.79	2254	754	33	24	56153	76153	
	15000	30 × 50	5.43	6.41	2254	754	27	21	46153	26153	
	22000	35 × 50	6.07	7.16	3304	1104	27	21	56223	76223	
	40	1500	22 × 25	1.65	2.01	364	124	114	65	57152	77152
		2200	22 × 30	2.04	2.49	532	180	87	50	57222	77222
3300		25 × 30	2.43	2.99	796	268	71	45	57332	77332	
3300		22 × 40	2.78	3.39	796	268	60	37	47332	27332	
4700		30 × 30	2.96	3.61	1132	380	59	40	57472	77472	
4700		25 × 40	3.26	3.90	1132	380	51	32	47472	27472	
6800		30 × 40	3.94	4.81	1636	548	42	29	57682	77682	
6800		25 × 50	4.10	5.00	1636	548	39	26	47682	27682	
10000		35 × 40	4.18	5.10	2404	804	46	29	57103	77103	
10000		30 × 50	4.98	6.08	2404	804	36	24	47103	27103	
15000		35 × 50	5.21	6.36	3604	1204	36	24	57153	77153	



ELECTRICAL DATA AND ORDERING INFORMATION FOR 058 SERIES										
U _R (V)	C _R 100 Hz (μ F)	NOMINAL CASE SIZE \varnothing D \times L (mm)	I _R 100 Hz 105 °C (A)	I _R \geq 10 kHz 105 °C (A)	I _{L1} 1 min (μ A)	I _{L5} 5 min (μ A)	ESR 100 Hz (m Ω)	Z 10 Hz (m Ω)	CATALOG NUMBER 2222 058	
									2-TERM.	3-TERM.
50	1000	22 \times 25	1.50	1.83	304	104	138	69	51102	71102
	1500	22 \times 30	1.88	2.29	454	154	102	54	51152	71152
	2200	25 \times 30	2.27	2.77	664	124	82	47	51222	71222
	2200	22 \times 40	2.55	3.11	664	124	71	38	41222	21222
	3300	30 \times 30	2.81	3.43	994	334	66	41	51332	71332
	3300	25 \times 40	3.07	3.75	994	334	57	33	41332	21332
	4700	30 \times 40	3.77	4.60	1414	474	47	30	51472	71472
	4700	25 \times 50	3.85	4.70	1414	474	43	27	41472	21472
	6800	35 \times 40	4.01	4.89	2044	684	49	30	51682	71682
	6800	30 \times 50	4.74	5.78	2044	684	38	24	41682	21682
	10000	35 \times 50	5.04	6.15	3004	1004	38	24	51103	71103
63	680	22 \times 25	1.17	1.43	261	90	228	150	58681	78681
	1000	22 \times 30	1.46	1.78	382	130	170	115	58102	78102
	1500	25 \times 30	1.76	2.15	571	193	137	85	58152	78152
	1500	22 \times 40	2.00	2.44	571	193	115	85	48152	28152
	2200	30 \times 30	2.27	2.77	836	281	101	70	58222	78222
	2200	25 \times 40	2.40	2.93	836	281	94	70	48222	28222
	3300	30 \times 40	3.07	3.75	1251	420	70	50	58332	78332
	3300	25 \times 50	3.07	3.75	1251	420	70	50	48332	28332
	4700	35 \times 40	3.65	4.45	1781	596	60	45	58472	78472
	4700	30 \times 50	3.88	4.73	1781	596	53	45	48472	28472
	6800	35 \times 50	4.58	5.59	2574	861	46	35	58682	78682
100	330	22 \times 25	0.92	1.12	202	70	370	250	59331	79331
	470	22 \times 30	1.14	1.39	286	98	280	190	59471	79471
	680	25 \times 30	1.35	1.65	412	140	232	140	59681	79681
	680	22 \times 40	1.57	1.92	412	140	190	140	49681	29681
	1000	30 \times 30	1.79	2.40	604	204	163	115	59102	79102
	1000	25 \times 40	1.85	2.26	604	204	158	115	49102	29102
	1500	30 \times 40	2.45	2.99	904	304	111	85	59152	79152
	1500	25 \times 50	2.38	2.90	904	304	116	85	49152	29152
	2200	35 \times 40	3.05	3.72	1324	444	86	65	59222	79222
	2200	30 \times 50	3.13	3.82	1324	444	82	65	49222	29222
	3300	35 \times 50	3.84	4.68	1984	664	64	50	59332	79332

Table 3

ELECTRICAL DATA AND ORDERING INFORMATION FOR 059 SERIES										
U _R (V)	C _R 100 Hz (μ F)	NOMINAL CASE SIZE \varnothing D \times L (mm)	I _R 100 Hz 105 °C (A)	I _{L1} 1 min (μ A)	I _{L5} 5 min (μ A)	ESR 100 kHz (m Ω)	Z 10 kHz (m Ω)	CATALOG NUMBER 2222 059		
								2-TERM.	3-TERM.	
200	100	22 \times 25	0.53	124	44	1280	730	52101	72101	
	150	22 \times 30	0.67	184	64	850	540	52151	72151	
	220	22 \times 35	0.86	268	92	610	430	32221	12221	
	220	25 \times 30	0.87	268	92	610	430	52221	72221	
	330	30 \times 30	1.12	400	136	435	300	52331	72331	
	330	25 \times 40	1.12	400	136	435	300	42331	22331	
	470	30 \times 35	1.46	568	192	335	225	32471	12471	
	470	25 \times 50	1.25	568	192	335	225	42471	22471	
	680	30 \times 45	1.87	820	276	235	155	32681	12681	
	680	35 \times 35	1.85	820	276	235	155	62681	82681	
	1000	35 \times 50	2.45	1204	404	160	125	52102	72102	
250	68	22 \times 25	0.49	106	38	1640	760	53689	73689	
	100	22 \times 30	0.62	154	54	1110	570	53101	73101	
	150	22 \times 35	0.82	229	79	795	440	33151	13151	
	150	25 \times 30	0.82	229	79	795	440	53151	73151	
	220	25 \times 35	1.03	334	114	540	300	33221	13221	
	220	30 \times 30	1.06	334	114	540	300	53221	73221	
	330	30 \times 35	1.43	499	169	385	225	33331	13331	
	330	25 \times 50	1.40	499	169	385	225	43331	23331	
	470	30 \times 45	1.79	709	239	270	155	33471	13471	
	470	35 \times 35	1.79	709	239	270	155	63471	83471	
	680	35 \times 45	2.25	1024	344	190	125	43681	23681	



ELECTRICAL DATA AND ORDERING INFORMATION FOR 059 SERIES									
U _R (V)	C _R 100 Hz (µF)	NOMINAL CASE SIZE ØD × L (mm)	I _R 100 Hz 105 °C (A)	I _{L1} 1 min (∞A)	I _{L5} 5 min (µA)	ESR 100 kHz (mΩ)	Z 10 kHz (mΩ)	CATALOG NUMBER 2222 059	
								2-TERM.	3-TERM.
385	33	22 × 25	0.32	80	29	3860	3000	58339	78339
	47	22 × 30	0.41	113	40	2710	2100	58479	78479
	68	22 × 35	0.53	161	56	1870	1460	38689	18689
	68	25 × 30	0.52	161	56	1870	1460	58689	78689
	100	30 × 30	0.72	235	81	1270	1010	58101	78101
	100	25 × 40	0.72	235	81	1270	1010	48101	28101
	150	30 × 40	0.99	351	119	850	675	58151	78151
	150	25 × 50	0.99	351	119	850	675	48151	28151
	220	35 × 40	1.31	512	173	580	465	58221	78221
	220	30 × 50	1.31	512	173	580	465	48221	28221
	330	35 × 50	1.75	766	258	390	320	58331	78331
400	47	22 × 30	0.30	117	42	4260	3490	56479	76479
	68	22 × 35	0.38	167	58	2950	2420	36689	16689
	68	25 × 30	0.41	167	58	2950	2420	56689	76689
	100	30 × 30	0.55	244	84	2020	1660	56101	76101
	100	25 × 40	0.55	244	84	2020	1660	46101	26101
	150	30 × 35	0.68	364	124	1350	1110	36151	16151
	150	25 × 50	0.78	364	124	1350	1110	46151	26151
	220	35 × 40	0.94	532	180	930	760	56221	76221
	220	30 × 50	0.94	532	180	930	760	46221	26221
		330	35 × 50	1.25	796	260	620	510	56331

ADDITIONAL ELECTRICAL DATA		
PARAMETER	CONDITIONS	VALUE
Voltage		
Surge voltage	≤ 250 V versions	U _s = 1.15 × U _R
	≥ 385 V versions	U _s = 1.1 × U _R
Reverse voltage		U _{rev} ≤ 1 V
Current		
Leakage current	after 1 minute at U _R	I _{L1} ≤ 0.006 C _R × U _R + 4 µA
	after 5 minutes at U _R	I _{L5} ≤ 0.002 C _R × U _R + 4 µA
Inductance		
Equivalent series inductance (ESL)	all case sizes	typ. 19 nH
		max. 25 nH

CAPACITANCE (C)

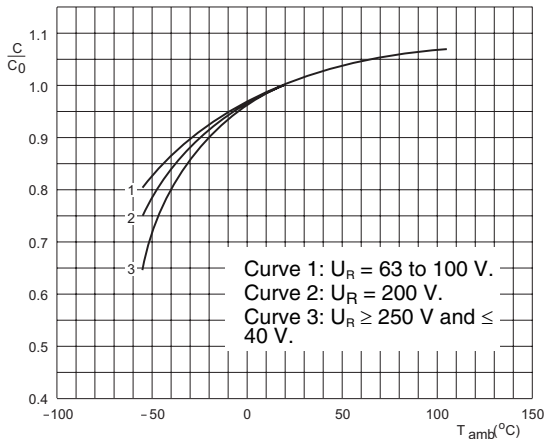

C₀ = capacitance at 20 °C and 100 Hz.

Fig.6 Typical multiplier of capacitance as a function of ambient temperature.

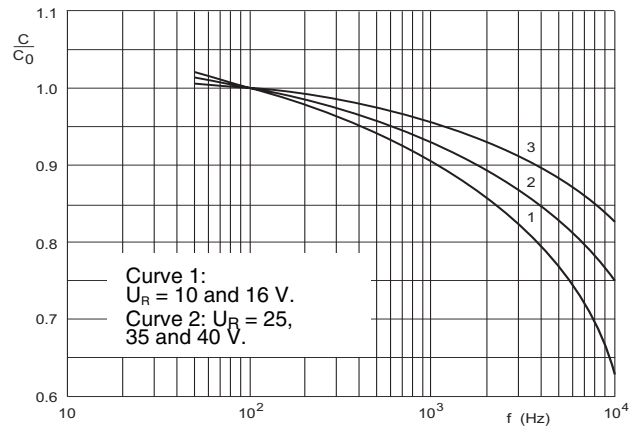

C₀ = capacitance at 20 °C and 100 Hz.

Fig.7 Typical multiplier of capacitance as a function of frequency.



EQUIVALENT SERIES RESISTANCE (ESR)

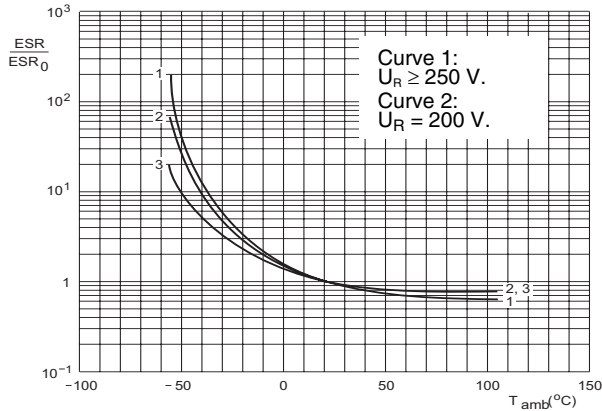

ESR_0 = typical at 20 °C and 100 Hz.

Fig.8 Typical multiplier of ESR as a function of ambient temperature.

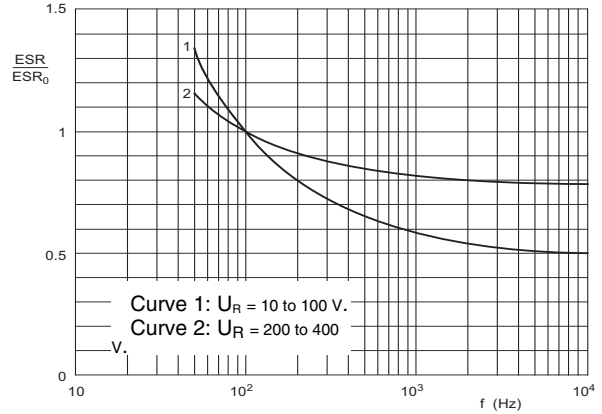

ESR_0 = typical at 20 °C and 100 Hz.

Fig.9 Typical multiplier of ESR as a function of frequency.

IMPEDANCE (Z)

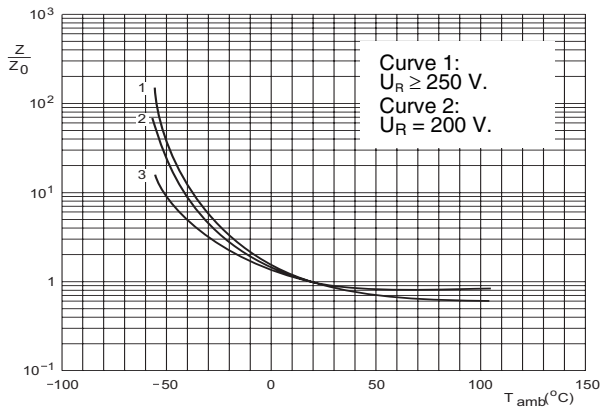

Z_0 = typical impedance at 20 °C and 10 kHz.

Fig.10 Typical multiplier of impedance as a function of ambient temperature.

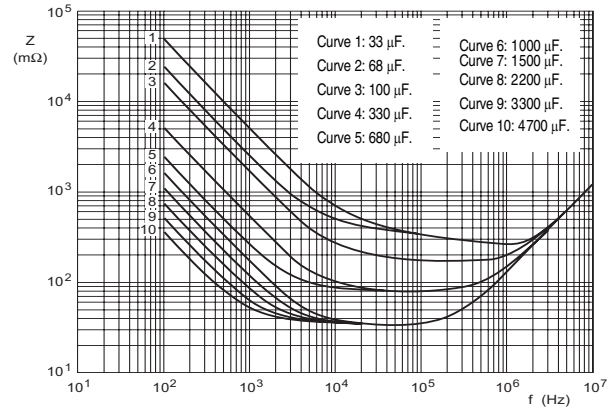

Case $\varnothing D \times L = 22 \times 25$ mm.

$T_{amb} = 20$ °C.

Fig.11 Typical impedance as a function of frequency.

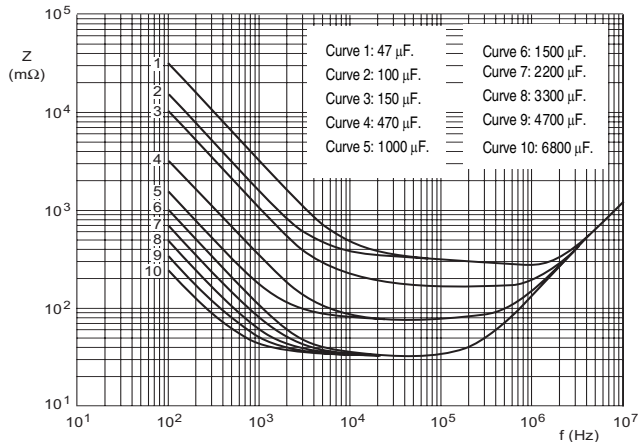

Case $\varnothing D \times L = 22 \times 30$ mm.

$T_{amb} = 20$ °C.

Fig.12 Typical impedance as a function of frequency.

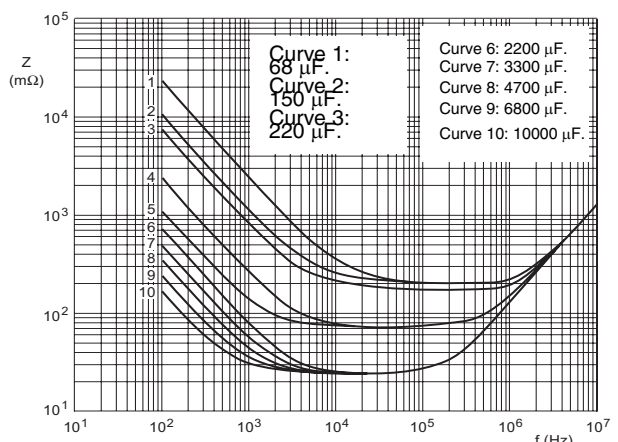

Case $\varnothing D \times L = 25 \times 30$ and 22×40 mm.

$T_{amb} = 20$ °C.

Fig.13 Typical impedance as a function of frequency.

IMPEDANCE (Z)

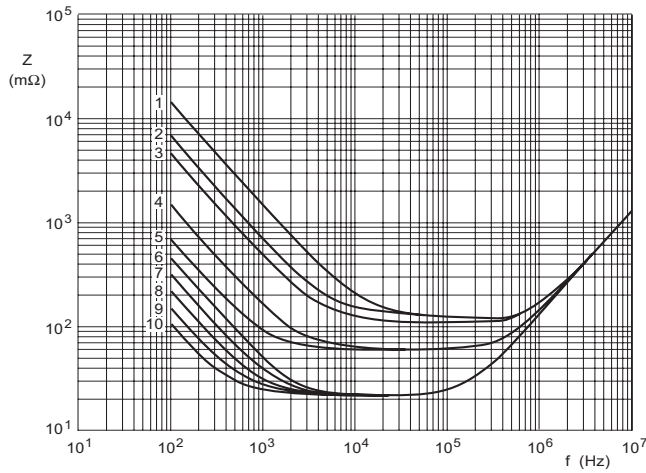

Curve 1: 100 μ F.
Curve 2: 220 μ F.
Curve 6: 3300 μ F.
Curve 7: 4700 μ F.
Curve 8: 6800 μ F.
Curve 9: 10000 μ F.
Curve 10: 15000 μ F.

Case $\varnothing D \times L = 30 \times 30$ and 25×40 mm. $T_{amb} = 20$ $^{\circ}C$.

Fig.14 Typical impedance as a function of frequency.

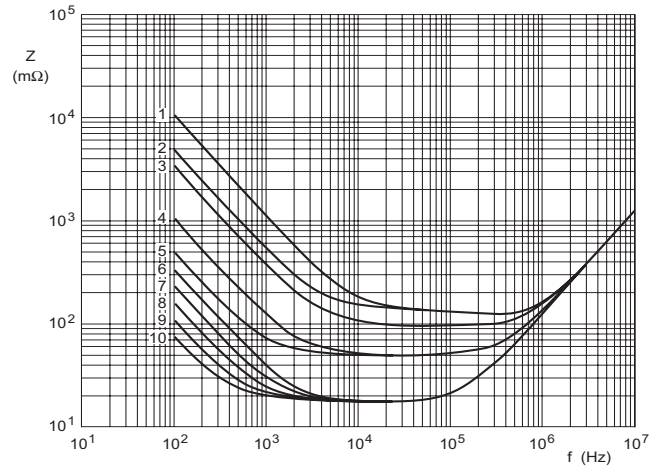

Curve 1: 150 μ F.
Curve 2: 330 μ F.
Curve 6: 4700 μ F.
Curve 7: 6800 μ F.
Curve 8: 10000 μ F.
Curve 9: 15000 μ F.
Curve 10: 22000 μ F.

Case $\varnothing D \times L = 30 \times 40$ and 25×50 mm. $T_{amb} = 20$ $^{\circ}C$.

Fig.15 Typical impedance as a function of frequency.

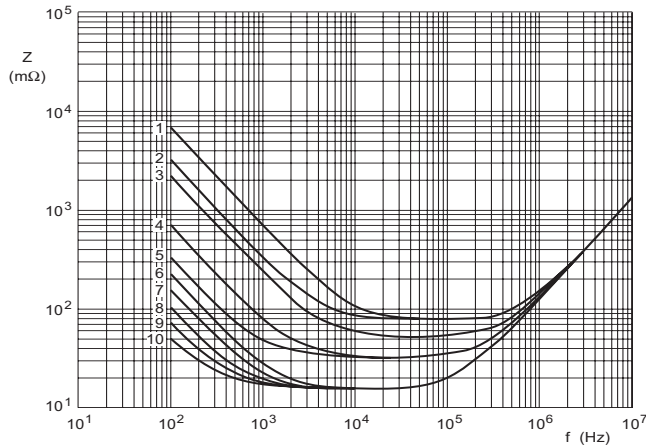

Curve 1: 220 μ F.
Curve 2: 470 μ F.
Curve 6: 6800 μ F.
Curve 7: 10000 μ F.
Curve 8: 15000 μ F.
Curve 9: 22000 μ F.
Curve 10: 33000 μ F.

Case $\varnothing D \times L = 35 \times 40$ and 30×50 mm. $T_{amb} = 20$ $^{\circ}C$.

Fig.16 Typical impedance as a function of frequency.

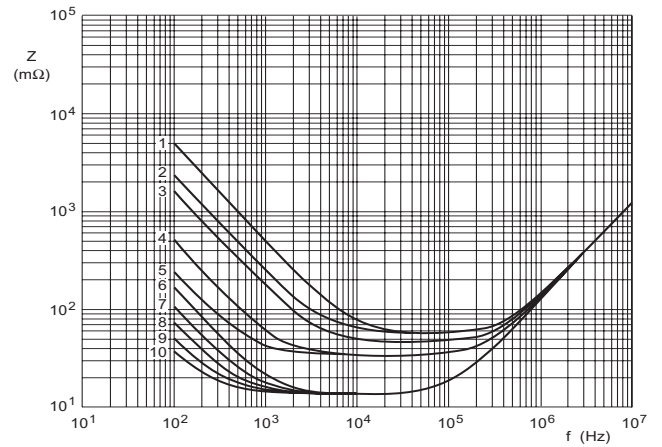

Curve 1: 330 μ F.
Curve 2: 680 μ F.
Curve 6: 10000 μ F.
Curve 7: 15000 μ F.
Curve 8: 22000 μ F.
Curve 9: 33000 μ F.
Curve 10: 47000 μ F.

Case $\varnothing D \times L = 35 \times 50$ mm. $T_{amb} = 20$ $^{\circ}C$.

Fig.17 Typical impedance as a function of frequency.

RIPPLE CURRENT AND USEFUL LIFE

MGA 454

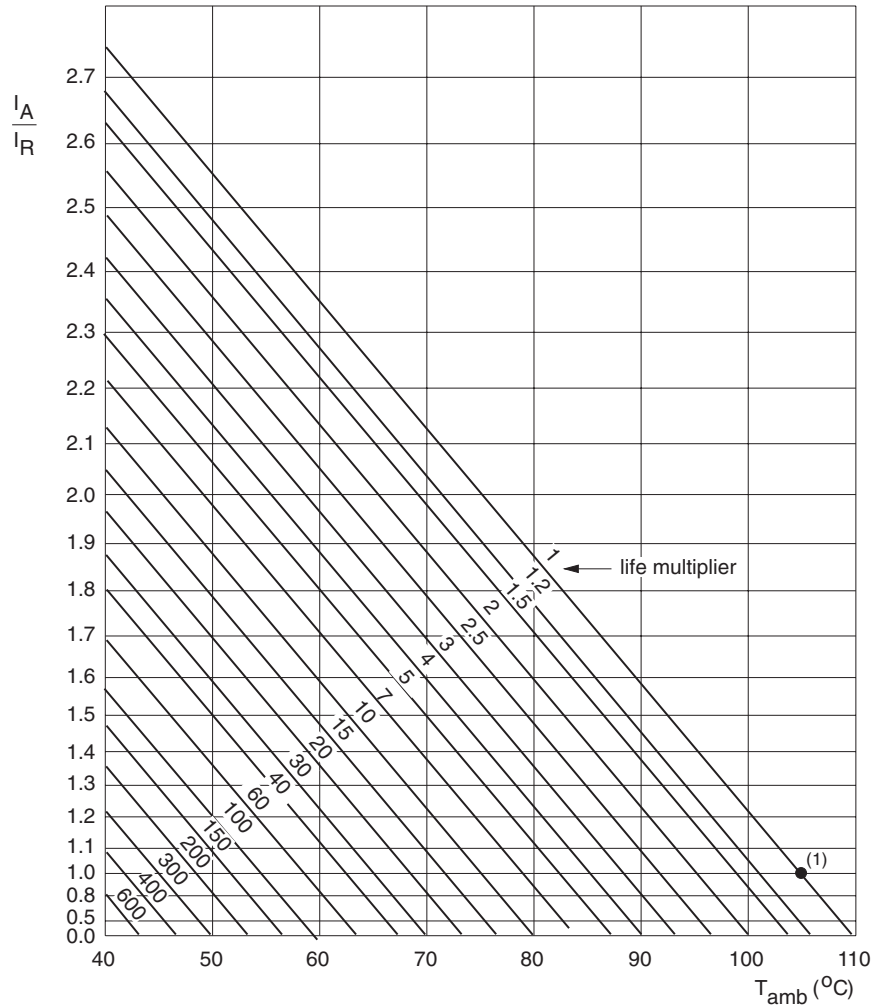

I_A = actual ripple current at 100 Hz.
 I_R = rated ripple current at 100 Hz and 105 °C.

(1) Useful life at 105 °C and I_R applied:
5000 hours for ≤ 50 V types;

Fig.18 Multiplier of useful life as a function of ambient temperature and ripple current load.

Table 4

MULTIPLIER OF RIPPLE CURRENT (I_R) AS A FUNCTION OF FREQUENCY			
FREQUENCY (Hz)	I_R MULTIPLIER		
	$U_R = 10 \text{ to } 25 \text{ V}$	$U_R = 40 \text{ to } 100 \text{ V}$	$U_R > 100 \text{ V}$
50	0.93	0.91	0.86
100	1.00	1.00	1.00
200	1.04	1.05	1.13
400	1.07	1.09	1.21
1000	1.11	1.13	1.29
2000	1.13	1.15	1.32
4000	1.15	1.18	1.35
≥10000	1.18	1.22	1.40



Table 5

TEST PROCEDURES AND REQUIREMENTS			
TEST		PROCEDURE (quick reference)	REQUIREMENTS
NAME OF TEST	REFERENCE		
Endurance	IEC 60384-4/ EN130300 subclause 4.13	$T_{amb} = 105\text{ }^{\circ}\text{C}$; U_R applied; $\leq 50\text{ V}$ types: 2000 hours; $\geq 63\text{ V}$ types: 5000 hours	$U_R \leq 100\text{ V}$; $\Delta C/C: \pm 15\%$ $U_R > 100\text{ V}$; $\Delta C/C: \pm 10\%$ $ESR \leq 1.3 \times \text{spec. limit}$ $Z \leq 2 \times \text{spec. limit}$ $I_{L5} \leq \text{spec. limit}$
Useful life	CECC 30301 subclause 1.8.1	$T_{amb} = 105\text{ }^{\circ}\text{C}$; U_R and I_R applied; $\leq 50\text{ V}$ types: 5000 hours; $\geq 63\text{ V}$ types: 10000 hours	$U_R \leq 100\text{ V}$; $\Delta C/C: \pm 45\%$ $U_R > 100\text{ V}$; $\Delta C/C: \pm 30\%$ $ESR \leq 3 \times \text{spec. limit}$ $Z \leq 3 \times \text{spec. limit}$ $I_{L5} \leq \text{spec. limit}$ no short or open circuit, no visible damage total failure percentage: $U_R \leq 100\text{ V}: \leq 1\%$; $U_R > 100\text{ V}: \leq 3\%$
Shelf life (storage at high temperature)	IEC 60384-4/ EN130300 subclause 4.17	$T_{amb} = 105\text{ }^{\circ}\text{C}$; no voltage applied; 500 hours after test: U_R to be applied for 30 minutes, 24 to 48 hours before measurement	$\Delta C/C: \pm 10\%$ $ESR \leq 1.2 \times \text{spec. limit}$ $I_{L5} \leq 2 \times \text{spec. limit}$



Notice

Specifications of the products displayed herein are subject to change without notice. Vishay Intertechnology, Inc., or anyone on its behalf, assumes no responsibility or liability for any errors or inaccuracies.

Information contained herein is intended to provide a product description only. No license, express or implied, by estoppel or otherwise, to any intellectual property rights is granted by this document. Except as provided in Vishay's terms and conditions of sale for such products, Vishay assumes no liability whatsoever, and disclaims any express or implied warranty, relating to sale and/or use of Vishay products including liability or warranties relating to fitness for a particular purpose, merchantability, or infringement of any patent, copyright, or other intellectual property right.

The products shown herein are not designed for use in medical, life-saving, or life-sustaining applications. Customers using or selling these products for use in such applications do so at their own risk and agree to fully indemnify Vishay for any damages resulting from such improper use or sale.