

### FEATURES

- Carbon resistive element.
- High mechanical endurance.
- Upon request:
  - Detents
  - Stereo matching
  - Switch
  - Nut & washer

### MECHANICAL SPECIFICATIONS

- Mechanical rotation angle:  $310^\circ \pm 5^\circ$
- Electrical rotation angle:  $290^\circ \pm 20^\circ$
- Torque: 0.5 to 1.5 Ncm. (0.7 to 2.1 in-oz)
- Stop torque: > 80 Ncm. (> 112 in-oz)

### ELECTRICAL SPECIFICATIONS

- Range of values (\*)  
 $100\Omega \leq R_n \leq 5\text{ M}$  (Decad. 1.0 - 2.0 - 2.2 - 2.5 - 4.7 - 5.0)
- Tolerance (\*):  $100\Omega \leq R_n \leq 1\text{M}$  .....  $\pm 20\%$   
 $1\text{M}\Omega < R_n \leq 5\text{M}$  .....  $\pm 30\%$
- Max. Voltage: 250 VDC (lin) 150 VDC (no lin)
- Nominal Power  $50^\circ\text{C}$  ( $122^\circ\text{F}$ ) (see power rating curve)  
0.25 W (lin) 0.12 W (no lin)
- Taper (\*) (Log. & Alog. only  $R_n > 1\text{K}$ ) Lin ; Log; Alog.
- Residual resistance:  $\leq 0.1\%$   $R_n$  ( $2\Omega$  min)
- Equivalent Noise Resistance:  $\leq 3\%$   $R_n$  ( $3\Omega$  min.)
- Operating temperature\*\*:  $-25^\circ\text{C} + 70^\circ\text{C}$  ( $-13^\circ\text{F} + 158^\circ\text{F}$ )

\* Others upon request

\*\* Up to  $85^\circ\text{C}$  depending on application

### HOW TO ORDER

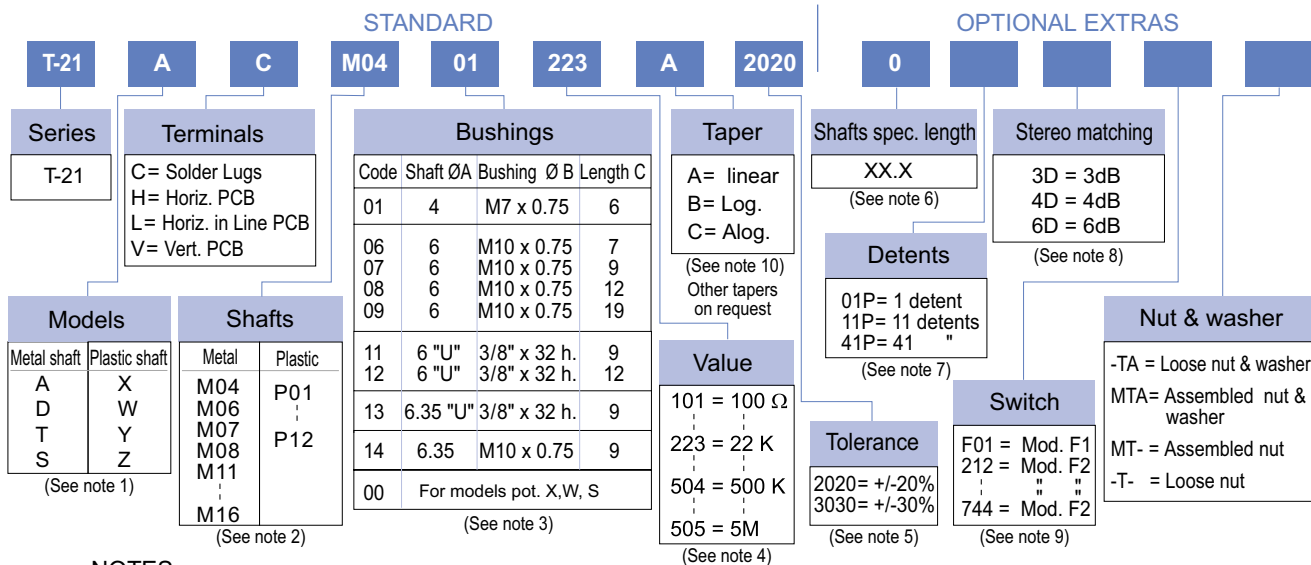

### NOTES:

- MODELS : Models D y T are not available with "V" terminals.
- SHAFTS: The codes indicate diameter and length. M08: Code for the double potentiometer.
- BUSHINGS ; The codes types 11, 12 and 13 have an antirotation lug (at  $90^\circ\text{CW}$ ). Plastic shaft and double model are only available with Ø6 bushing.
- VALUE:
  - Code:  $\frac{10}{1} = 100\Omega$
  - Number of zeros
  - 2 first digits of the value.
  - In models "D" and "T" with different values, order under special drawing number.
- Tolerance (special), upon request. Example: +7% Code: 07, -5% Code: 05
- Shafts special length:
  - Only for special length and plain shafts (not knurled). Example: Shaft Ø6 L= 24.5
  - Flatted and slotted shafts, etc. will need drawing.
  - Shaft M08 (T-21D) with other length, order under special drawing number. Recommendation : Shaft L > 60 ..... bushing C = 19
- DETENTS : - Not available in models with plastic shaft X, W, Y, Z. - Detents and switch are not compatible.
- Stereo matching: Only available in tandem models and upon request.
- SWITCHES : Two types of switches are offered: F1 and F2.
  - F1 = The code is "F01"
  - Plastic shafts are only available if they are code P10, P11 or P12
  - F2 = (Only with metal shaft) Indicate the corresponding I-21 switch code.
- Switch option not available with anti-log taper.

NOTE: The information contained here should be used for reference purposes only.

## HOW TO ORDER CUSTOM DRAWING

T-21 A C + DRAWING NUMBER (Max. 16 digits)

This way of ordering should be used for options which are not included in the "How to order" standard and optional extras.

## STANDARD OPTIONS

Shaft length ..... 0 standard  
 Detents ..... Without  
 Stereo matching ..... Only for model "T" and upon request  
 Switch ..... No switch  
 Nut & washer ..... Without nut and washer

### MODELS WITH METALIC SHAFTS

T-21 A

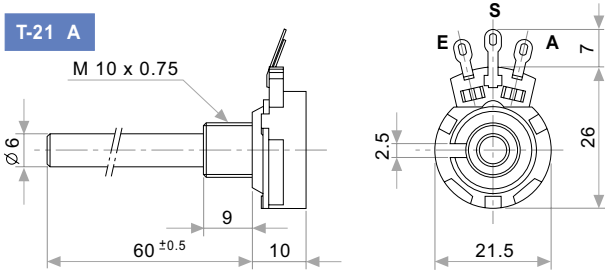

T-21 T

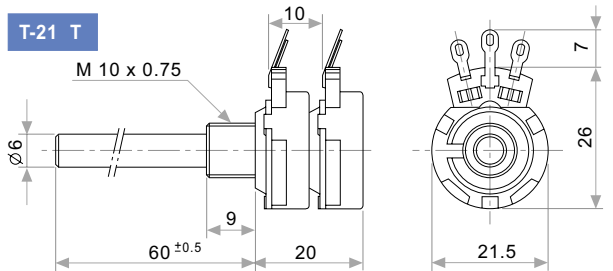

A = Initial  
 S = Wiper  
 E = Final

T-21 D

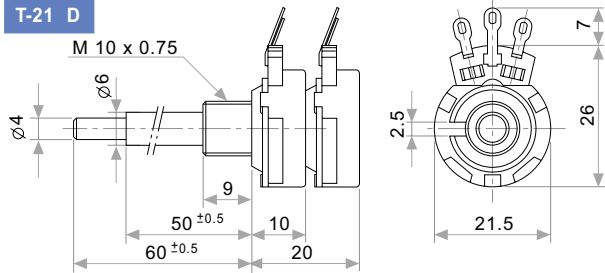

T-21 S

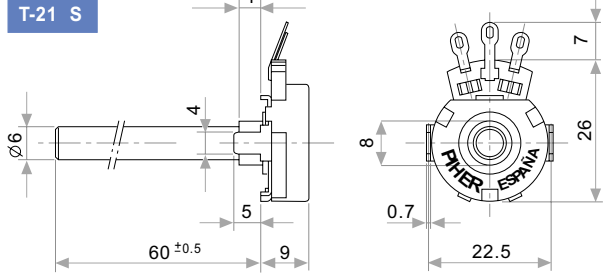

### MODELS WITH PLASTIC SHAFTS

T-21 X

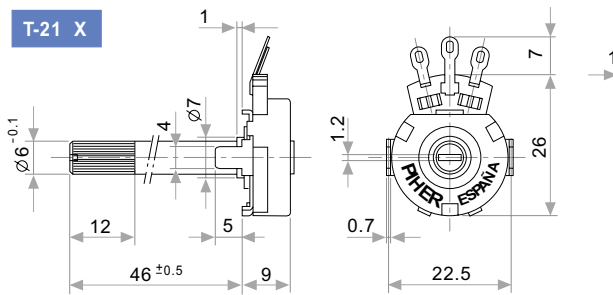

T-21 W

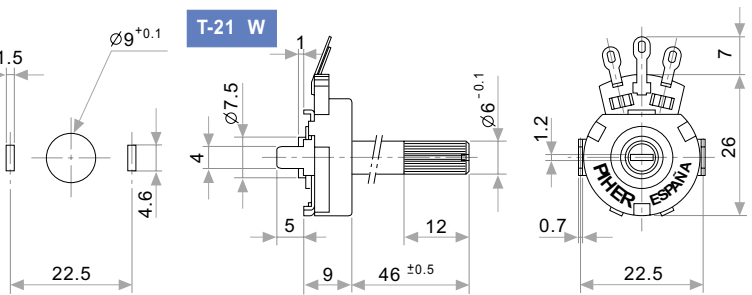

T-21 Y

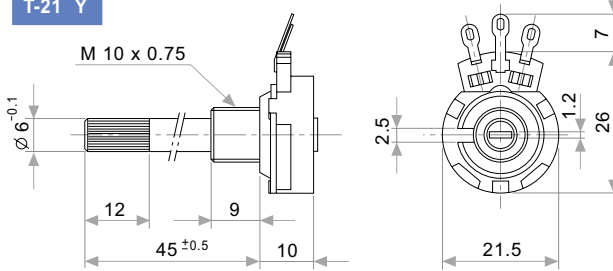

T-21 Z

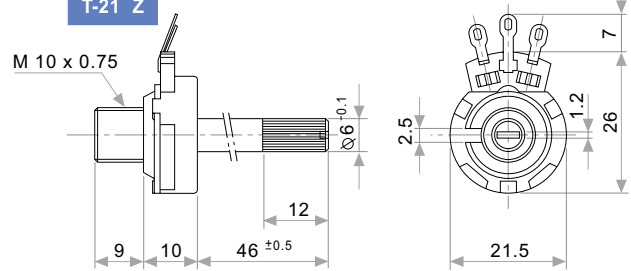

### TERMINALS

T-21 C

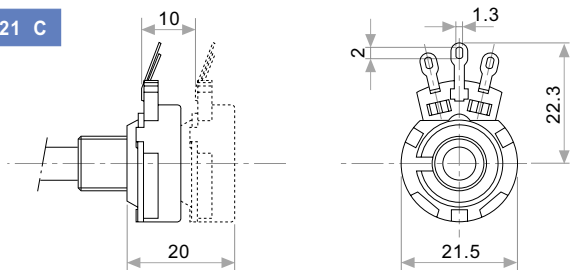

T-21 H

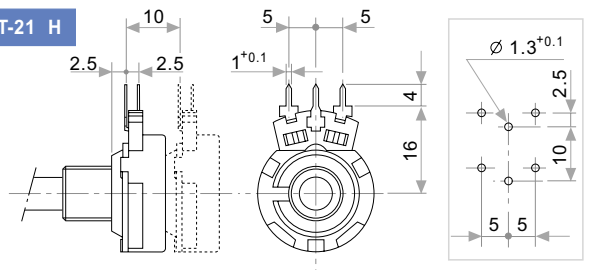

T-21 L

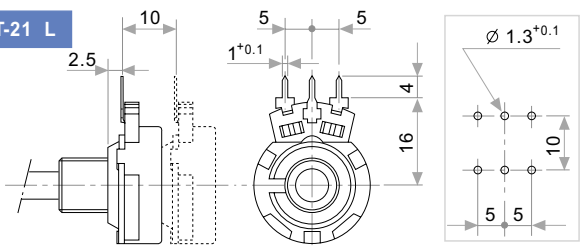

T-21 V

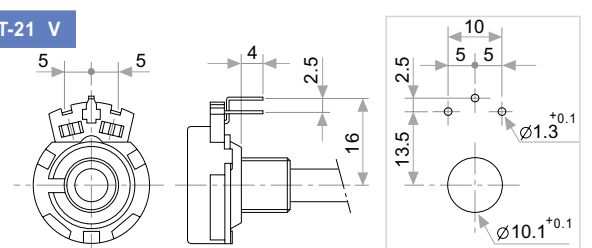

## PLASTIC SHAFTS

T-21 X/Y without Switch		
T-21 X	T-21 Y	CODE
L = 2	/	P01
L = 10	/	P02
L = 16	L = 15	P03
L = 26	L = 25	P04
L = 36	L = 35	P05
L = 46	L = 45	P06

T-21Y w/Sw F01	
T-21 Y	CODE
L = 16	P10
L = 25	P11
L = 46	P12

T-21 W/Z without Switch		
T-21 W	T-21 Z	CODE
L = 26	L = 26	P07
L = 36	L = 36	P08
L = 46	L = 46	P09

## METALIC SHAFTS

### PLAIN SHAFT

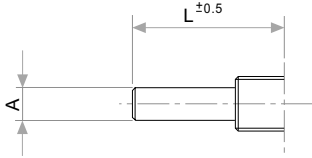

A	L	CODE
4	40	M04
6	60	M06
6.35	60	M07
4/6	50/60	M08

### KNURLED SHAFT

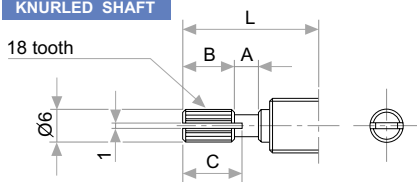

L	A	B	C	CODE
15	2	6	7	M11
20	2	10	11	M12
25	4	12	14	M13
30	4	12	14	M14
35	4	12	14	M15
40	4	12	14	M16

### UNDER DRAWING

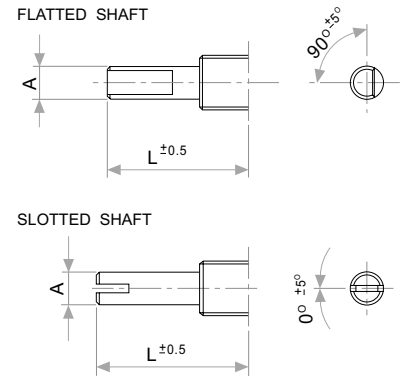

## BUSHINGS

### STANDARD

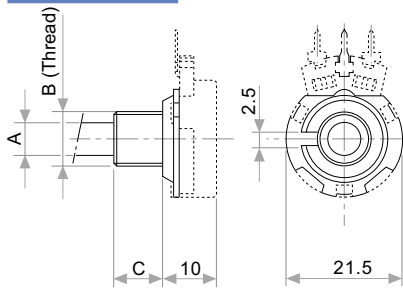

CODE	A	B	C
01	4	M7 x 0.75	6
06	6	M10 x 0.75	7
07	6	M10 x 0.75	9
08	6	M10 x 0.75	12
09	6	M10 x 0.75	19
14	6.35	M10 x 0.75	9

### NON ROTARY PAWL

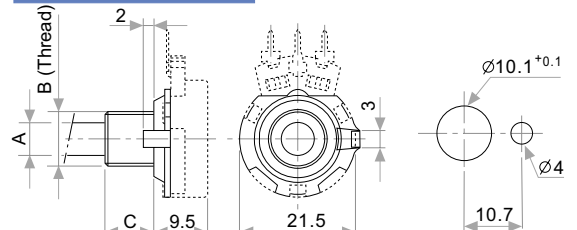

CODE	A	B	C
11	6	3/8" x 32 h.	9
12	6	3/8" x 32 h.	12
13	6.35	3/8" x 32 h.	9

## DETENTS

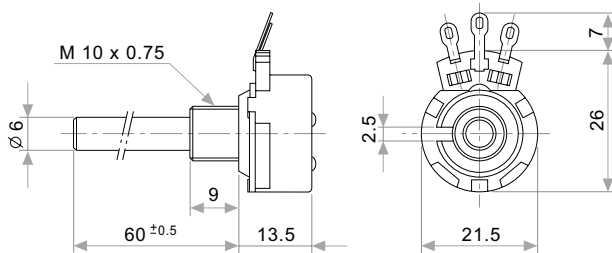

## TAPERS

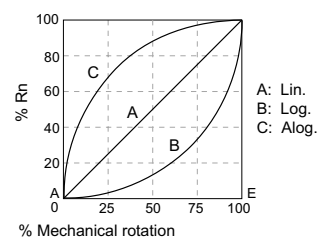

## POWER RATING CURVE

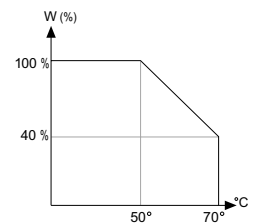

## TESTS

## TYPICAL VARIATIONS

ELECTRICAL LIFE	1.000 h. 50°C; 0.25 W	±5 %
MECHANICAL LIFE* :	25.000 (10-15 CPM)	±3 % (Rn < 1 M)
TEMPERATURE COEFFICIENT	-25°C; +70°C	±300 ppm (Rn < 100 K)
THERMAL CYCLING	16 h. @ 85°C; 2h. @ -25°C	±2.5 %
DAMP HEAT	500 h. 40°C 95% HR	±5 %
VIBRATION (for each plane X,Y,Z)	2 h. @ 10 Hz - 55 Hz.	±2 %

NOTE: Out of range values may not comply these results.

(\*) only applicable to values ≥ 1K. For lower values please consult.

## PACKAGING

Boxes of 150 / 200 pieces (160 x 110 x 85 mm.)

## SWITCH F1

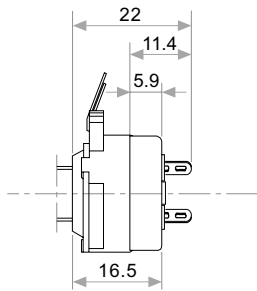

MECHANICAL & ELECTRICAL SPECIFICATIONS	F 1
OPERATING ANGLE	50° ±5°
OPERATING TORQUE	3-7 Ncm (4.2-9.8 in-oz)
MAXIMUM AXIAL CHARGE	80 N; 17 pounds
NOMINAL CURRENT	1A; 250 VAC
CONTACT RESISTANCE	≤ 25mΩ
TEST VOLTAGE (DIELECTRIC STRENGTH)	2000 V (50 Hz)

## SWITCH F2

ELECTRICAL SPECIFICATIONS	F 2
SWITCH RATING	2 or 4A; 250 VAC
CONTACT RESISTANCE	≤ 25 mΩ
DIELECTRIC STRENGTH	2000 V
INSULATION RESISTANCE	100 MΩ
MECHANICAL SPECIFICATIONS	F 2
OPERATING ANGLE (ROTARY)	35° ± 5°
PUSH / PUSH OPERATING TRAVEL	4 mm.
PUSH / PULL OPERATING TRAVEL	2.5 mm.
OPERATING TORQUE (ROTARY)	2 to 9 Ncm. (2.8 to 12.7oz/in)
OPERATING FORCE (Push/Push ; Push/Pull)	4 to 7 N (14 to 27oz)
MECHANICAL LIFE	10.000 cycles
STOP TORQUE	> 100 Ncm. (142 oz/in)

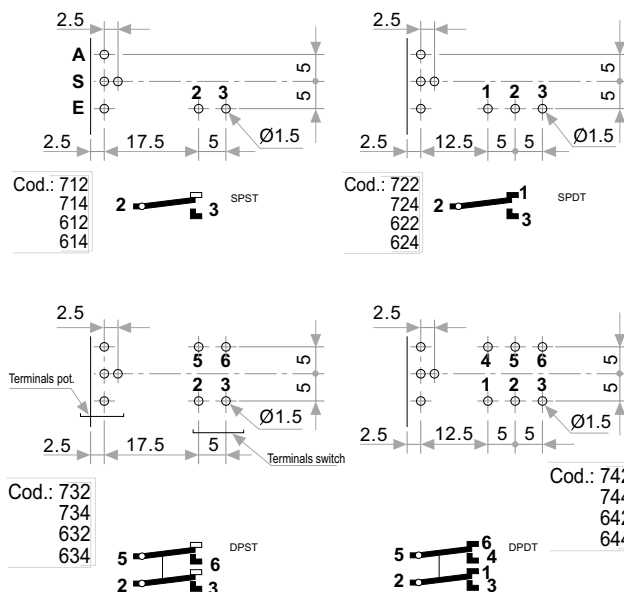
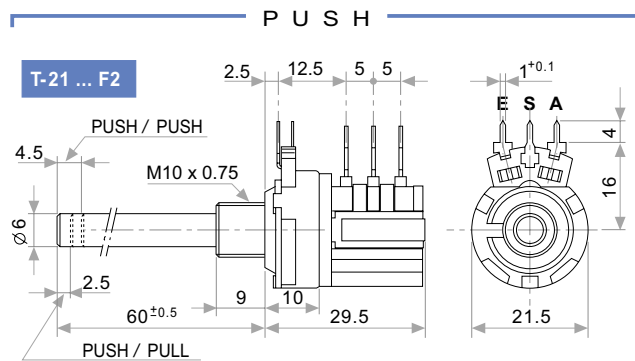

## I-21 HOW TO ORDER (only switch)

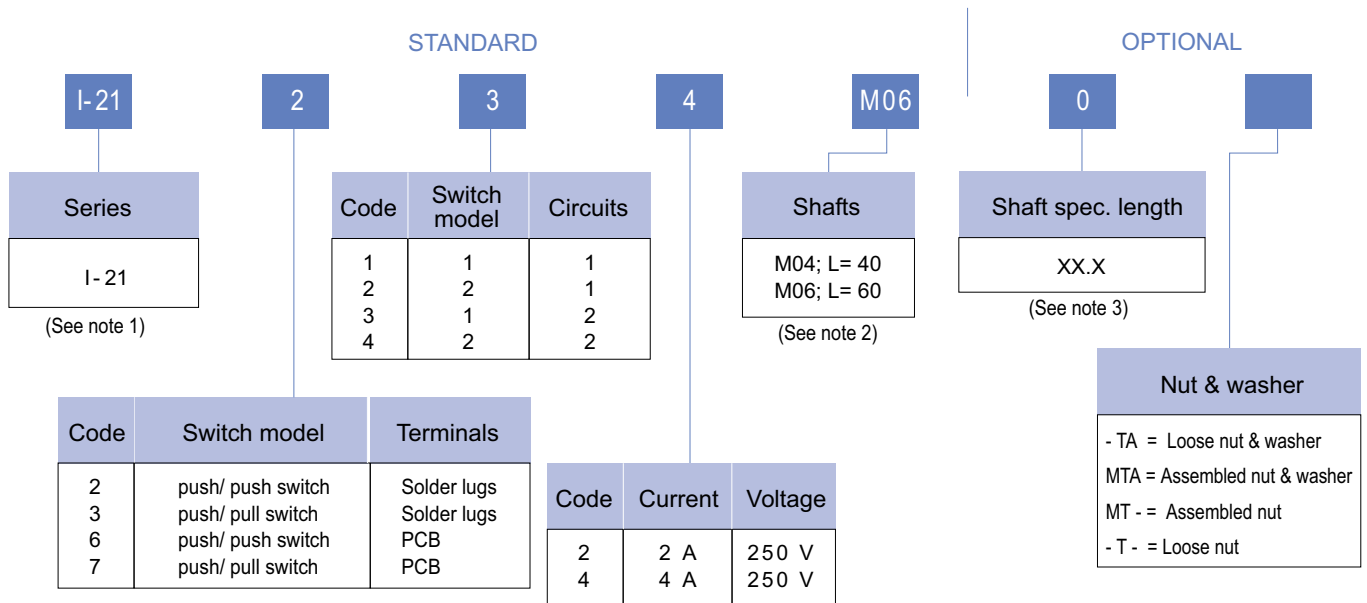

### NOTES:

(1) When only the switch is ordered (without potentiometer), it will be called "I-21" followed by the respective code.

(2) The shaft and bushings for "I-21" are:

COD.	A	B	L
M04	4	M7 x 0.75	40
M06	6	M10 x 0.75	60

(3) Only for special length and plain shaft (not knurled).

Example: E: Ø6 L= 24.5 M06 24.5 → special length  
 Flatted and slotted shafts, etc. will need drawing.

### HOW TO ORDER CUSTOM DRAWING

I-21 + DRAWING NUMBER (Max. 16 digits)

This way of ordering should be used for options which are not included in the "How to order" standard and optional extras.

### STANDARD OPTIONS

Shaft length ..... See note 2

Nut & washer ..... Without nut and washer

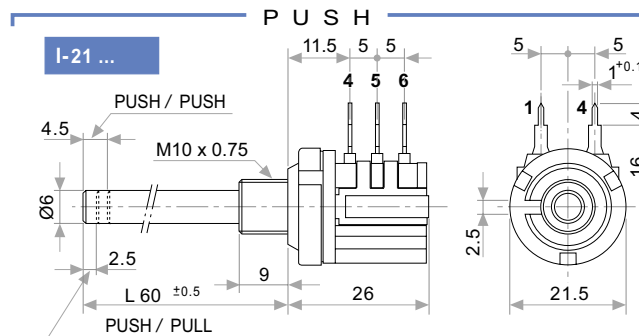

### NUT & WASHER

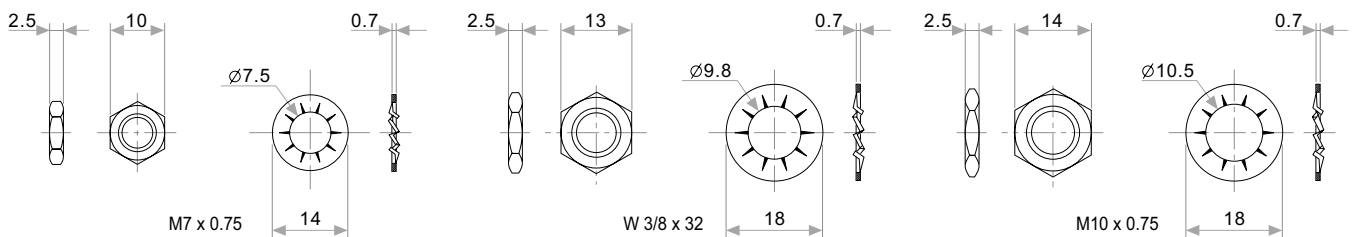

### PACKAGING

Boxes of 100 pieces ( 160 x 110 x 85 mm.).