

Features

- Conductive plastic
- PC board and bushing mount
- Plastic bushing and plastic shaft
- Withstands typical industrial washing processes
- Compact package saves board and panel space
- Audio taper versions available as special order

3310 - 9 mm Square Sealed Panel Control

Electrical Characteristics

Standard Resistance Range - Linear	1 K ohms to 1 megohm
Total Resistance Tolerance - Linear Tapers	±20 %
Independent Linearity.....	±5 %
Absolute Minimum Resistance.....	2 ohms maximum
Effective Electrical Angle.....	270 ° ±15 °
Contact Resistance Variation.....	1 % or 1 ohm (whichever is greater)
Dielectric Withstanding Voltage (MIL-STD-202 – Method 301)	
Sea Level	900 VAC minimum
70,000 Feet	350 VAC minimum
Insulation Resistance	1,000 megohms minimum
Power Rating @ 70 °C (Derate to 0 at 125 °C - Voltage Limited By Power Dissipation or 200 VAC, Whichever is Less)	0.25 watts
Theoretical Resolution	Essentially infinite

Environmental Characteristics

Operating Temperature Range	-40 °C to +125 °C
Storage Temperature Range	-55 °C to +125 °C
Temperature Coefficient Over Storage Temperature Range	±1,000 ppm/°C
Vibration	30 G
Total Resistance Shift	±1 % maximum
Voltage Ratio Shift.....	±1 % maximum
Shock	100 G
Total Resistance Shift	±1 % maximum
Voltage Ratio Shift.....	±1 % maximum
Load Life	1,000 hours
Total Resistance Shift	±10 % TRS maximum
Rotational Life (No Load)	50,000 cycles
Total Resistance Shift	±5 % TRS maximum
Contact Resistance Variation	3 % or 3 ohms, whichever is greater
Moisture Resistance	MIL-STD-303, Method 103, Condition B
Total Resistance Shift	±10 % TRS maximum
IP Rating	IP67

Mechanical Characteristics

Stop Strength.....	5.65 N-cm (8 oz.-in.)
Mechanical Angle	300 ° nominal
Torque	
Starting.....	3.53 N-cm (5.0 oz.-in.) maximum
Running	3.53 N-cm (5.0 oz.-in.) maximum
Mounting (Torque on Bushing)45 N-cm (4.0 lb.-in.) max [plastic bushing]; 79 N-cm (7.0 lb.-in.) max [metal bushing]
Weight (Single Section)	4.5 grams
(Each Additional Section)	2.5 grams
Terminals	Solderable pins
Soldering Condition.....	5 seconds at 360 °C maximum. Recommended hand soldering using Sn95/Ag5 no clean solder, 0.025 wire diameter.
Marking	Manufacturer's trademark, model number, product code, terminal style, resistance code and date code
Ganging.....	2 cups maximum
Hardware	One lockwasher and one mounting nut is shipped with each potentiometer, except where noted in the part number.
Flammability.....	Conforms to UL94V-0
Epoxy	Conforms to UL 94V-1

3310 - 9 mm Square Sealed Panel Control

BOURNS®

Standard Resistance Table

Resistance (Ohms)	Resistance Code
1,000	102
2,000	202
5,000	502
10,000	103
20,000	203
50,000	503
100,000	104
200,000	204
500,000	504
1,000,000	105

Popular values listed in boldface. Consult factory for special resistances.

Part Numbering System

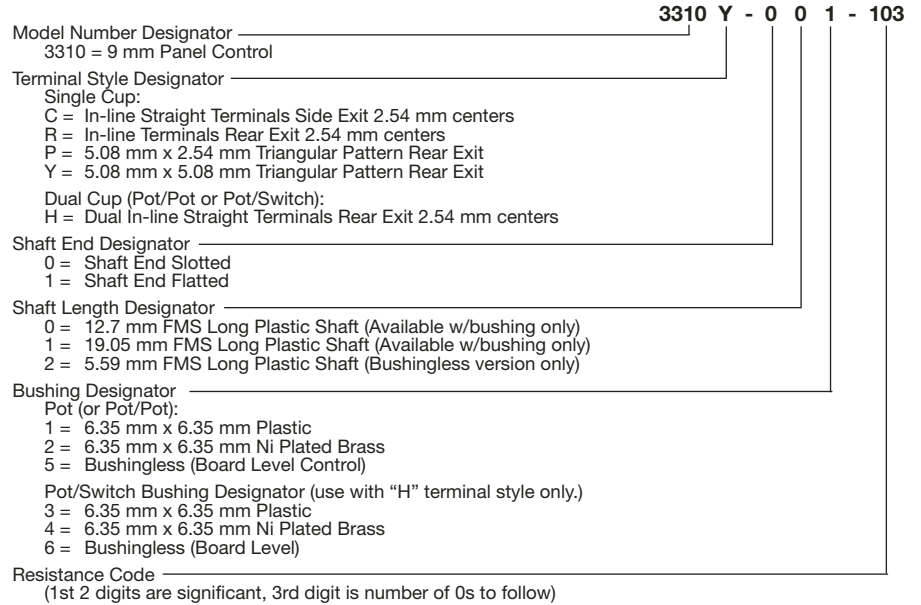

3310 - 9 mm Square Sealed Panel Control

BOURNS®

Product Dimensions

COMMON DIMENSIONS

3310-001

Plastic Bushing
Slotted Shaft

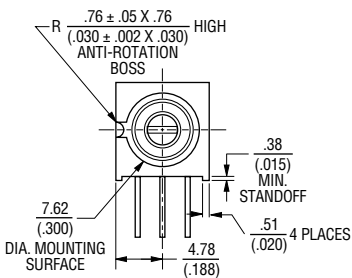
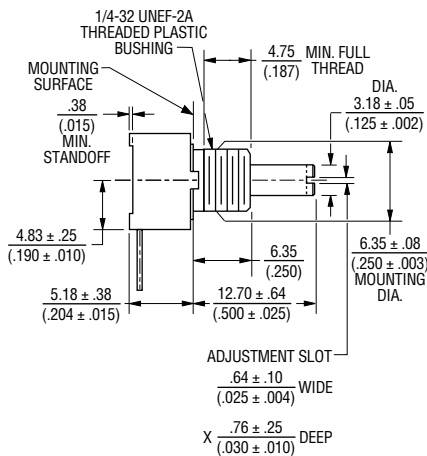
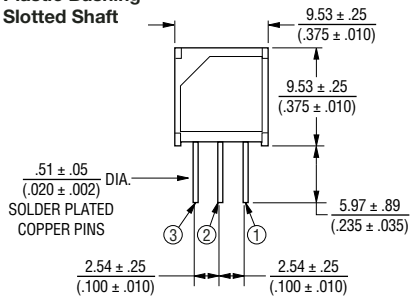

MOUNTING HOLE PATTERN

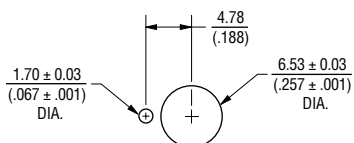

3310C-001

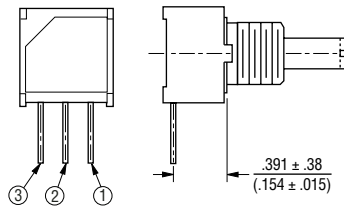

3310P-001

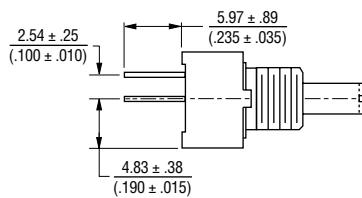
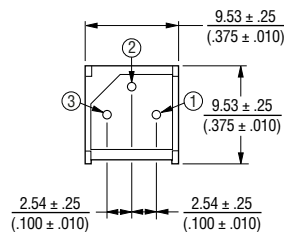

3310R-001

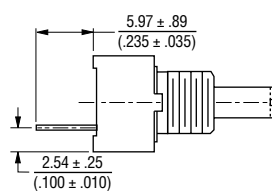
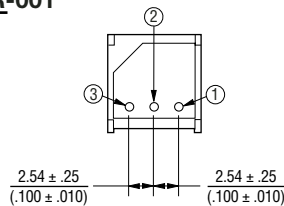

3310Y-001

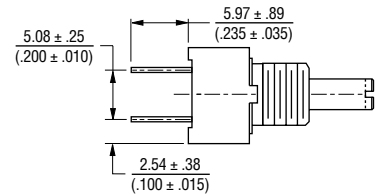
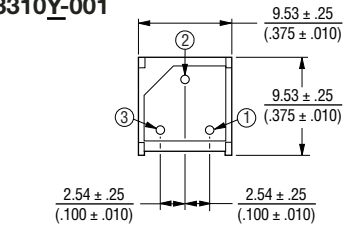

COMMON DIMENSIONS

3310C-101

Plastic Flatted Shaft

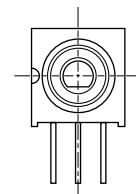
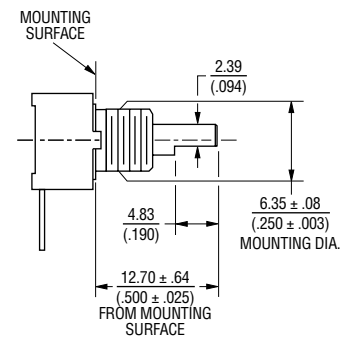

DIMENSIONS ARE: $\frac{\text{MM}}{\text{(INCHES)}}$

3310 - 9 mm Square Sealed Panel Control

BOURNS®

Product Dimensions

COMMON DIMENSIONS 3310-002

Metal Bushing

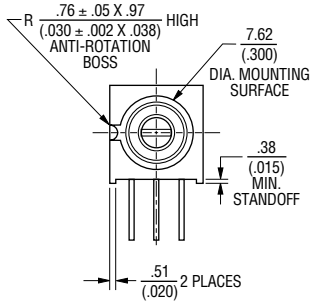
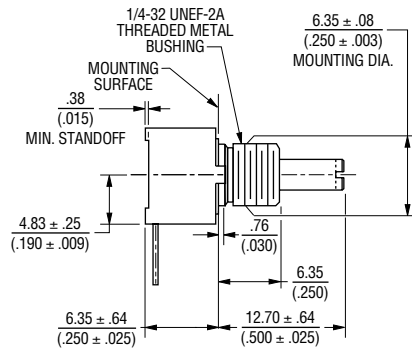

3310P-025 *

Bushingless

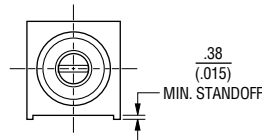
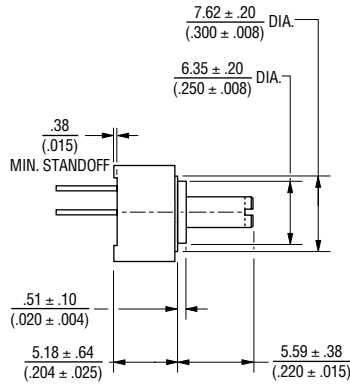

3310C-002

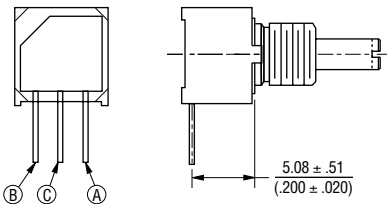

NOTE: * Only recommended shaft length for bushingless version

DIMENSIONS ARE: $\frac{\text{MM}}{\text{(INCHES)}}$

3310 - 9 mm Square Sealed Panel Control

BOURNS®

Product Dimensions

COMMON DIMENSIONS 3310H-003 Pot/Switch Dual Cup Plastic Bushing

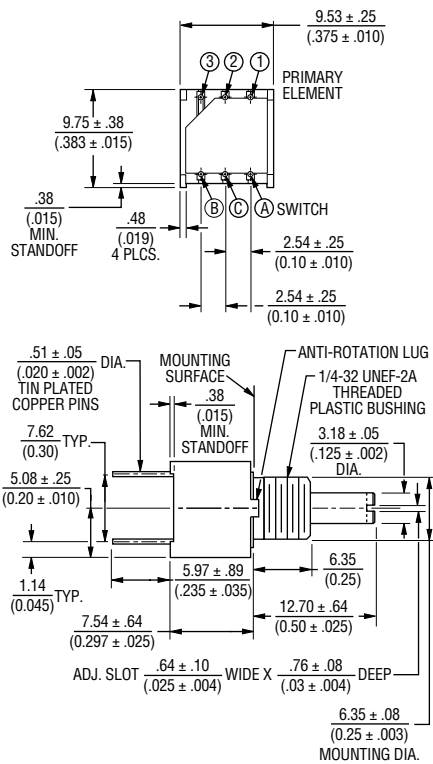

3310H-025* Pot/Pot Dual Cup Bushingless

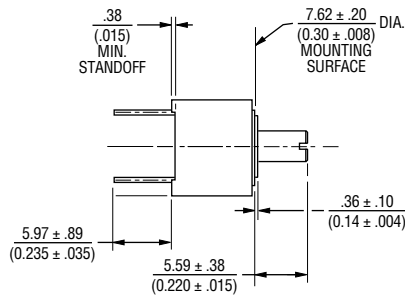
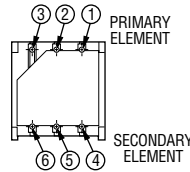

Pot/Pot Dual Cup

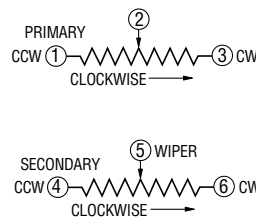

3310H-002 Pot/Pot Dual Cup Metal Bushing

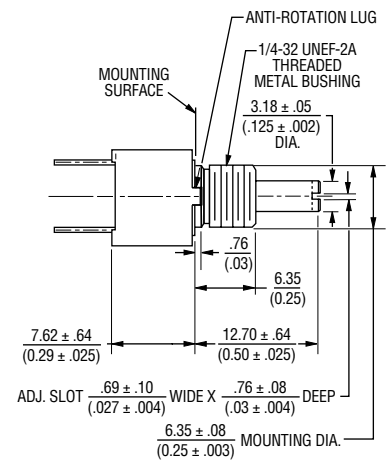
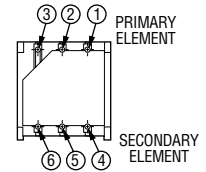

Pot/Switch Dual Cup

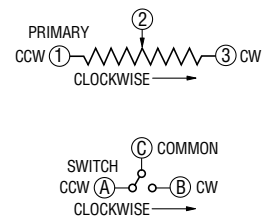

Pot Single Cup

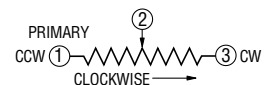

NOTE: * Only recommended shaft length for bushingless version

DIMENSIONS ARE: $\frac{\text{MM}}{\text{(INCHES)}}$

REV. 11/04

Specifications are subject to change without notice. Customers should verify actual device performance in their specific applications.