

Features

- Single Turn / Cermet / Industrial / Sealed
- Available on tape and reel
- Available with a knob for finger adjust
- Available with extended shaft
- Available with cross-slot rotor

Features

- Top and side adjust types (F, P, H, W, X most popular)
- High voltage types available (see Model 3386 HV2/3386 HV3 for details)
- RoHS compliant* version available

3386 - 3/8" Square Trimming Potentiometer

Electrical Characteristics

Standard Resistance Range10 to 2 megohms
(see standard resistance table)

Resistance Tolerance±10 % std.
(tighter tolerance available)

Absolute Minimum Resistance2 ohms max.

Contact Resistance Variation2 % or 3 ohms max.
(whichever is greater)

Adjustability

Voltage±0.05 %

Resistance±0.15 %

Resolution.....Infinite

Insulation Resistance500 vdc.
1,000 megohms min.

Dielectric Strength

Sea Level900 vac

70,000 Feet350 vac

Adjustment Angle280 ° nom.

Environmental Characteristics

Power Rating (300 volts max.)

85 °C0.5 watt

125 °C0 watt

Temperature Range-55 °C to +125 °C

Temperature Coefficient±100 ppm/°C

Seal Test.....85 °C Fluorinert†

HumidityMIL-STD-202 Method 103
96 hours
(2 % ΔTR, 10 Megohms min.)

Vibration.....30 G (1 % ΔTR; 1 % ΔVR)

Shock.....100 G (1 % ΔTR; 1 % ΔVR)

Load Life ..1,000 hours 0.5 watt @ 70 °C
(3 % ΔTR; 1 % or 1 ohm,
whichever is greater, CRV)

Rotational Life200 cycles
(4 % ΔTR; 1 % or 1 ohm,
whichever is greater, CRV)

Physical Characteristics

Mechanical Angle310 ° nom.

Torque5.0 oz-in. max.

Stop Strength15.0 oz-in. min.

TerminalsSolderable pins

Weight0.03 oz.

MarkingManufacturer's
trademark, resistance code,
wiring diagram, date code,
manufacturer's model
number and style

FlammabilityU.L. 94V-0

Standard Packaging50 pcs. per tube

Wiper.....50 % (Actual TR) ±10 %

Adjustment ToolH-90

Common Dimensions Side Adjust

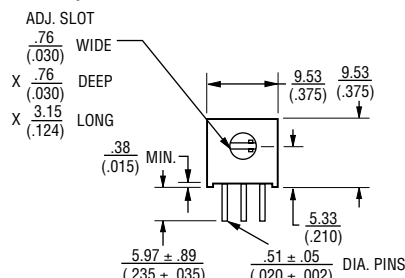

3386B

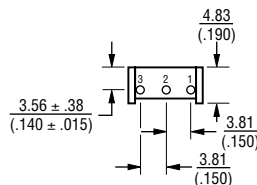

3386C

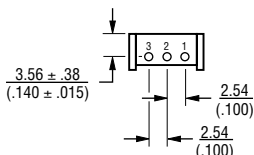

3386H

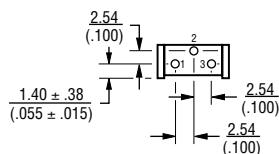

3386J

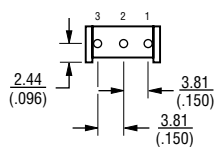

3386S

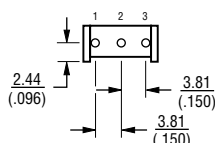

3386W

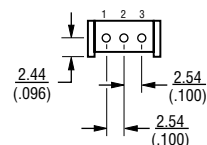

3386X

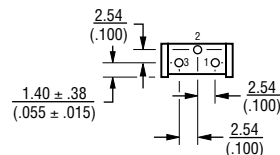

TOLERANCES: ± 0.25 (.010) EXCEPT WHERE NOTED

DIMENSIONS ARE: $\frac{\text{MM}}{(\text{INCHES})}$

Standard Resistance Table

Resistance (Ohms)	Resistance Code
10	100
20	200
50	500
100	101
200	201
500	501
1,000	102
2,000	202
5,000	502
10,000	103
20,000	203
25,000	253
50,000	503
100,000	104
200,000	204
250,000	254
500,000	504
1,000,000	105
2,000,000	205

Popular distribution resistance values listed in boldface. Special resistances available.

How To Order

3386 P - 1 - 103 T LF

Model _____

Style _____

Standard or Modified Product Indicator _____

-1 = Standard Product

-EY5 = Extended Shaft

Resistance Code _____

Optional Suffix Letter _____

T = Knob**

Packaging Designator _____

Blank = Tube (Standard)

R = Tape & Reel (W and U Pin Styles Only)

A = Ammo Pack (W and U Pin Styles Only)

Terminations _____

LF = 100 % Tin-plated (RoHS compliant)

Blank = 90 % Tin / 10 % Lead-plated (Standard)

**Knob option is available only in standard Tube packaging.

Consult factory for other available options.

*RoHS Directive 2002/95/EC Jan 27 2003 including Annex.
†"Fluorinert" is a registered trademark of 3M Co.
Specifications are subject to change without notice.
Customers should verify actual device performance in their specific applications.

3386 - 3/8" Square Trimming Potentiometer

BOURNS®

Common Dimensions Top Adjust

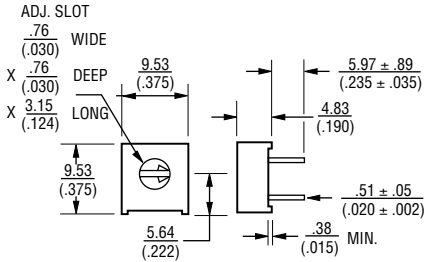

3386F

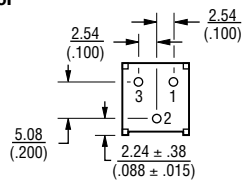

3386K

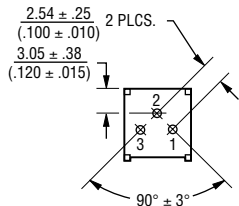

3386M

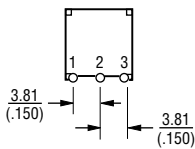

3386P

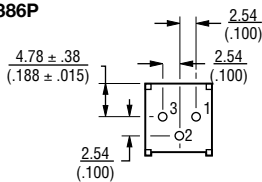

3386R

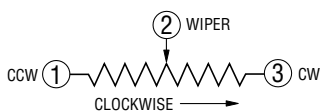
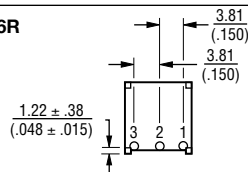

3386T

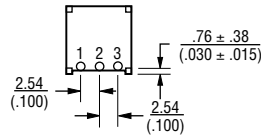

3386U

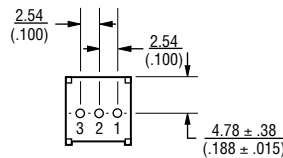

3386Y

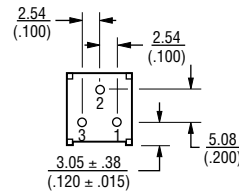

3386G

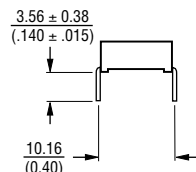
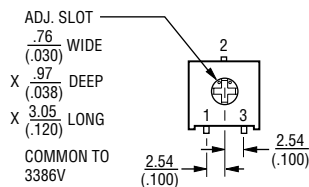

3386V

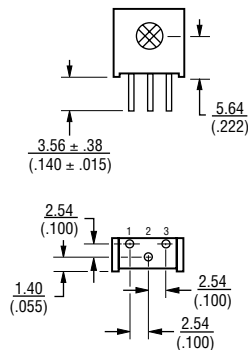

3386H-EY5 3386X-EY5 - SHOWN

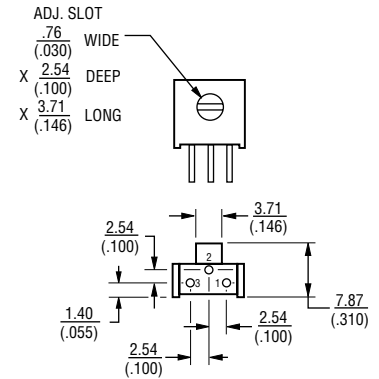

3386P-EY5

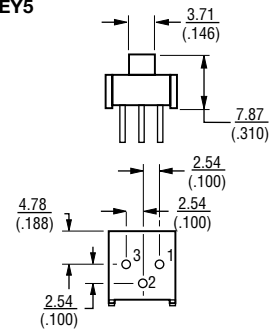

The Model 3386 is available with a knob for finger adjustment. Add suffix letter "T" to order code for F, P and X terminal styles.

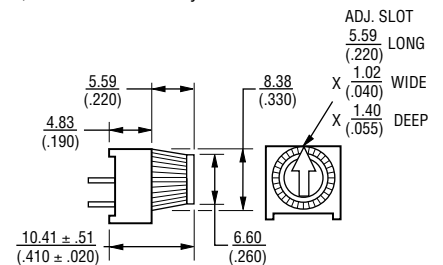

3386 - 3/8 " Square Trimming Potentiometer

BOURNS®

Packaging Specifications

SIDE ADJUST 3386W-1

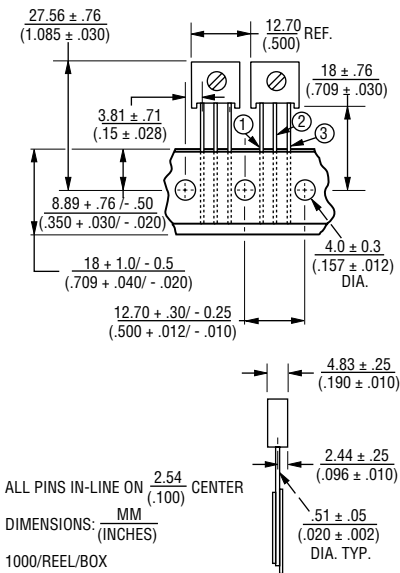

TOP ADJUST 3386U-1

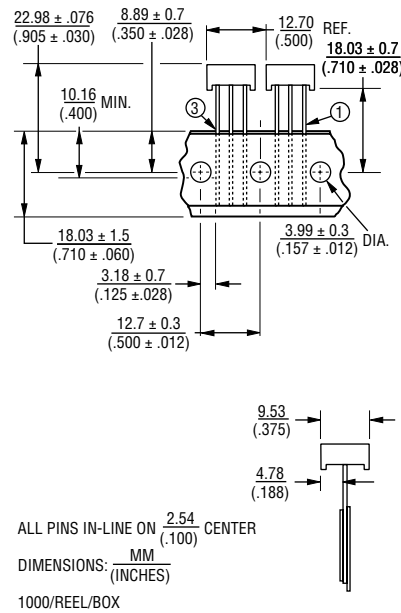

Meets EIA Specification 468.