

0805 AS

Engineer's Kit : EK-0805AS-X

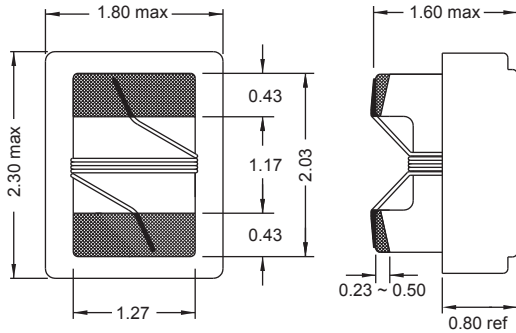

Single layer (typ)

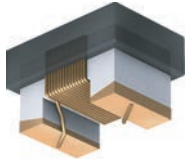
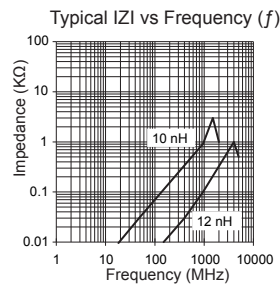
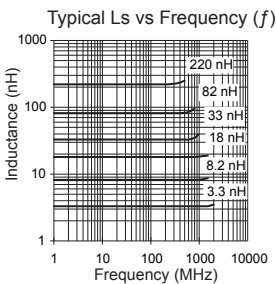
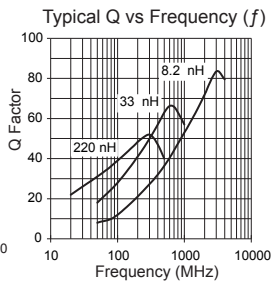
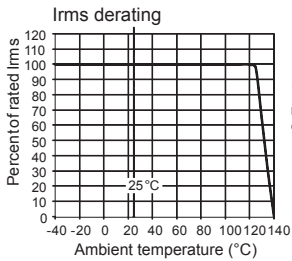
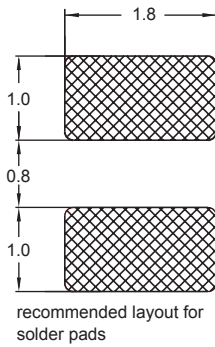

Part No	Inductance	fL	Tol	Q	fa	SRF	DCR	Rated DC
	L (nH)	(MHz)	± (%)	min	(MHz)	(MHz)	max (Ω)	Current (mA)
0805AS-2N7K-YY	2.7	250	10	80	1500	6000 min	0.08	600
0805AS-3N3K-YY	3.3	250	10	50	1500	6000 min	0.08	600
0805AS-3N6K-YY	3.6	250	10	25	1500	6000 min	0.18	600
*0805AS-3N9K-YY	3.9	250	10	25	1000	6000 min	0.20	600
0805AS-5N6K-YY	5.6	250	10	53	1000	5500 min	0.11	600
0805AS-5N8K-YY	5.8	250	10	50	1000	5500 min	0.11	600
0805AS-6N8K-YY	6.8	250	10	50	1000	5500 min	0.11	600
0805AS-8N0K-YY	8.0	250	10	51	1000	4700 min	0.12	600
0805AS-8N2K-YY	8.2	250	10	50	1000	4700 min	0.12	600
0805AS-010J-YY	10	250	5	43	1000	4300 min	0.13	600
0805AS-011J-YY	11	250	5	65	1000	4000 min	0.13	600
0805AS-012J-YY	12	250	5	50	500	4000 min	0.15	600
0805AS-015J-YY	15	250	5	50	500	3400 min	0.17	600
0805AS-018J-YY	18	250	5	53	500	3300 min	0.20	500
0805AS-022J-YY	22	250	5	57	500	2600 min	0.22	500
0805AS-027J-YY	27	250	5	55	500	2500 min	0.25	500
0805AS-033J-YY	33	250	5	60	500	2050 min	0.27	500
0805AS-036J-YY	36	250	5	60	500	2050 min	0.27	600
0805AS-039J-YY	39	250	5	60	500	2000 min	0.29	500
0805AS-047J-YY	47	200	5	65	500	1650 min	0.31	500
0805AS-048J-YY	48	200	5	65	500	1580 min	0.30	500
0805AS-056J-YY	56	200	5	64	500	1550 min	0.34	500
0805AS-068J-YY	68	200	5	65	500	1450 min	0.38	400
0805AS-075J-YY	75	200	5	55	500	1300 min	0.42	400
0805AS-082J-YY	82	150	5	67	500	1300 min	0.42	400
0805AS-R10J-YY	100	150	5	65	500	1200 min	0.46	400
0805AS-R12J-YY	120	150	5	52	250	1100 min	0.51	400
0805AS-R13J-YY	130	100	5	53	250	920 min	0.56	400
0805AS-R15J-YY	150	100	5	60	250	920 min	0.56	400
0805AS-R18J-YY	180	100	5	50	250	870 min	0.64	400
0805AS-R20J-YY	200	100	5	54	250	850 min	0.70	400
0805AS-R22J-YY	220	100	5	59	250	850 min	0.70	400
0805AS-R24J-YY	240	100	5	52	250	850 min	0.80	400
0805AS-R25J-YY	250	100	5	52	250	850 min	0.80	400
0805AS-R27J-YY	270	100	5	40	100	820 min	1.50	280
0805AS-R29J-YY	290	100	5	40	100	795 min	1.80	260
0805AS-R30J-YY	300	100	5	40	100	795 min	1.80	260
0805AS-R31J-YY	310	100	5	40	100	795 min	1.80	260
0805AS-R32J-YY	320	100	5	40	100	790 min	1.80	260
0805AS-R33J-YY	330	100	5	40	100	790 min	1.80	260
0805AS-R34J-YY	340	100	5	40	100	790 min	1.80	260
0805AS-R35J-YY	350	100	5	40	100	750 min	2.00	200
0805AS-R39J-YY	390	100	5	42	100	750 min	2.00	200
0805AS-R45J-YY	450	100	5	40	100	720 min	2.50	200
0805AS-R47J-YY	470	100	5	40	100	720 min	2.50	170
0805AS-R51J-YY	510	100	5	40	100	650 min	3.50	170
0805AS-R56J-YY	560	100	5	40	100	650 min	3.50	170
0805AS-R62J-YY	620	100	5	40	100	450 min	3.50	170
0805AS-R68J-YY	680	50	5	37	75	400 min	3.50	170
0805AS-R75K-YY	750	25	10	23	50	215 typ	2.35	180
0805AS-R80K-YY	800	25	10	23	50	215 typ	2.35	180
0805AS-R82K-YY	820	25	10	23	50	215 typ	2.35	180
0805AS-R91K-YY	910	25	10	23	50	215 typ	2.35	180
0805AS-1R0K-YY	1000	25	10	23	50	215 typ	2.35	180
0805AS-1R2K-YY	1200	7.9	10	15	50	150 typ	2.80	200
0805AS-1R5K-YY	1500	7.9	10	15	50	150 typ	3.00	200
0805AS-1R8K-YY	1800	7.9	10	15	50	80 typ	3.00	210
0805AS-2R0K-YY	2000	7.9	10	15	7.9	80 typ	3.50	170
0805AS-2R2K-YY	2200	7.9	10	15	7.9	80 typ	3.80	150
0805AS-2R4K-YY	2400	7.9	10	15	7.9	80 typ	3.80	120
0805AS-2R7K-YY	2700	7.9	10	15	7.9	80 typ	4.80	120
0805AS-3R0K-YY	3000	7.9	10	15	7.9	80 typ	5.00	120
0805AS-3R3K-YY	3300	7.9	10	15	7.9	80 typ	5.10	120
0805AS-3R6K-YY	3600	7.9	10	15	7.9	80 typ	5.50	100
0805AS-3R9K-YY	3900	7.9	10	15	7.9	80 typ	7.10	100
0805AS-4R3K-YY	4300	7.9	10	15	7.9	80 typ	7.20	100
0805AS-4R7K-YY	4700	7.9	10	15	7.9	50 typ	8.00	100
0805AS-5R6K-YY	5600	7.9	10	15	7.9	50 typ	9.50	90
*0805AS-6R8K-YY	6800	7.9	10	15	7.9	55 typ	13.3	80
*0805AS-8R2K-YY	8200	7.9	10	15	7.9	36 typ	14.0	60
*0805AS-100K-YY	10000	7.9	10	15	7.9	35 typ	16.0	60

Chip Inductors for RF Applications (Wire wound -open)

Material : Ceramic

SPQ : Reel 2500 [-01]
7500 [-04]

Remarks:

- For not listed inductance values please check availability with us.
- 2% and 5% tolerance available on request.
- All are AEC-Q200 Standard approved EXCEPT *.