

ALPHASTAT 16

Ausführung TANDEM mit Tragkäfig/multi turn
 Typ 63256-024XX
 Welle/shaft 4 mm L=30 mm
 Buchse/bushing M7x0,75
 Printausführung/for printed circuit
 Drehbereich/Rotation angle 270° +-5%
 Belastbarkeit/rated wattage lin 0,2W/log 0,05 W

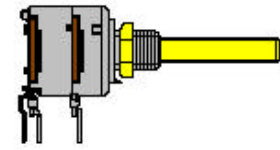

63256-024XX

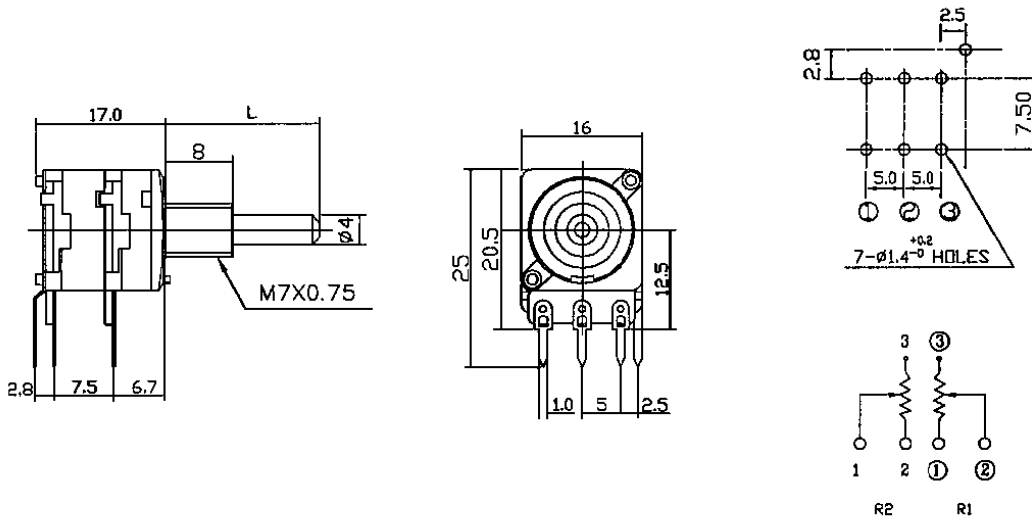

	Standard 63256-02400/—			Mittenrast/center click 63256-02410/—			Rast 11/11 clicks 63256-02420/—			Rast 41/41 clicks 63256-02440/—		
	lin	poslog	neglog	lin	poslog	neglog	lin	poslog	neglog	lin	poslog	neglog
1 k	4002*	4015	4030	4042	4055	4070	4082	4095	4110	4122	4135	4150
2,5 k	4003*	4016		4043	406		4083	4096		4123	4136	
5 k	4004*	4017*	4032	4044*	4057	4072	4084	4097	4112	4124	4137	4152
10 k	4005*	4018	4033	4045	4058	4073	4085	4098	4113	4125	4138	4153
25 k	4006*	4019		4046*	4059		4086	4099		4126	4139	
50 k	4007*	4020	4035	4047	4060	475	4087	4100	4115	4127	4140	5155
100 k	4008	4021	4036*	4048	4061	4076	4088	4101	4116	4128	4141	4156
250 k	4009*	4022		049	4062		4089	4102		4129	4142	
500 k	4010**	4023		4050	4063		4090	4103		4130	4143	
1 M	4011*	4024		4051	4064		4091	4104		4131	4144	

* lagermassige Ausführungen

ALPHASTAT 16

TECHNISCHE DATEN - SPECIFICATIONS

MECHANICAL

TOTAL ROTATION ANGLE	270°+-5%
ROTATION TORQUE	20~200 gf.cm
SHAFT STOP STRENGTH	6 kgf. cm/min.
SWITCH WORKING ANGLE	30 +-10
SWITCH WORKING TORQUE	800 gf.cm Max.
SWITCH CIRCUIT	D.P.D.T. S.P.D.T.

ELECTRICAL

RATED WATTAGE	FORM B 0,2W	FORM A 0,05W
RATED VOLTAGE	AC 200V	AC 150V
SWITCH RATING	DC 12V-1A	D.P.D.T.
INSULATION RESISTANCE	more than 1000 Mohm at DC 500V	
DIELECTRIC	AC 500V, 1 minute	

MANUFACTURING TOLERANCES

NOMINAL RESISTANCE (R_N)	>100 Ohm \leq 1M Ohm +-20%
STARTING VALUE R_a	lin/log. $R_a \leq 1 \times 10^3 R_N$
CLICK POSITION	center, 11 or 41 positions
CLICK TORQUE	100~400 gf.cm
TRACKING ERROR	volume control ~40~0dB < 3 dB tone, balance control \leq 2 dB at 50% point
SWITCH CONTACT RESISTANCE SWITCH RATING	less than 20 mOhm
ROTATION LIFE	15.000 cycles
SWITCH LIFE	10.000 cycles

ALPHASTAT 16

TECHNISCHE DATEN - SPECIFICATIONS

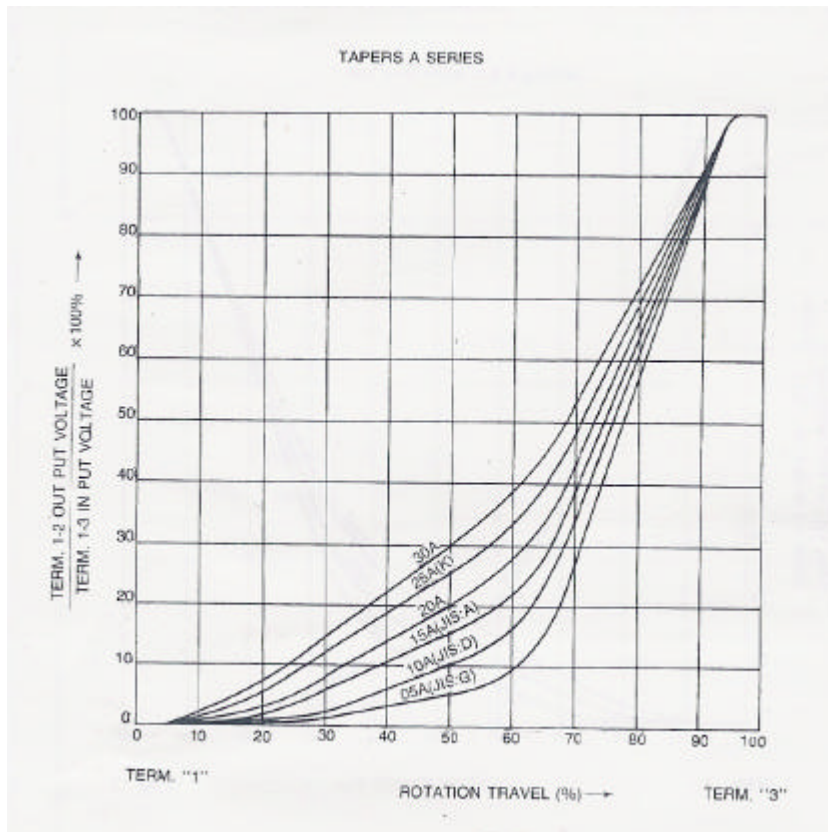
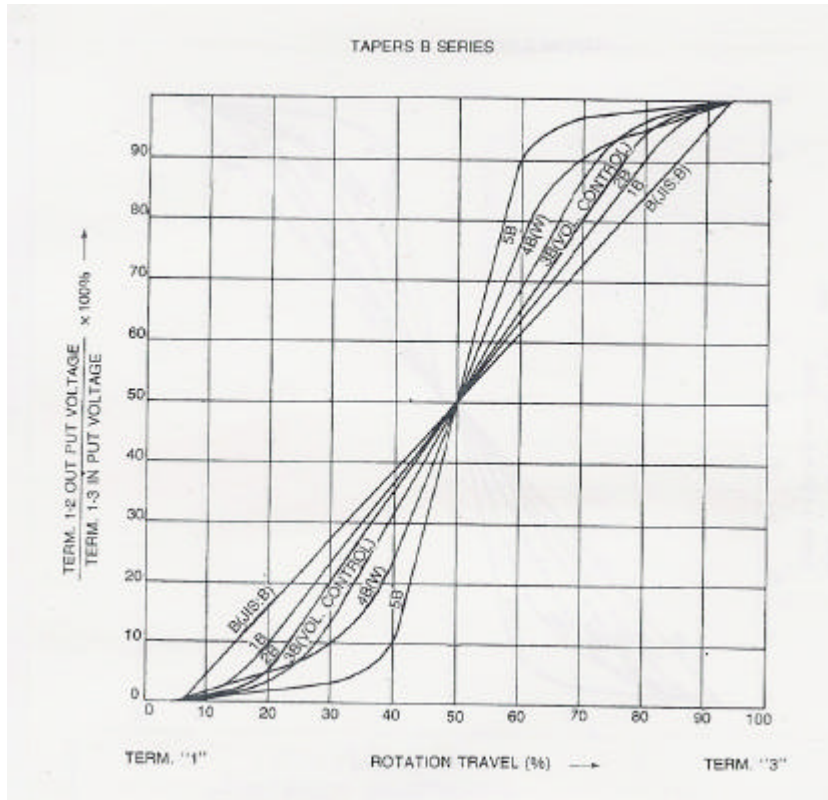

ALPHASTAT 16

TECHNISCHE DATEN - SPECIFICATIONS

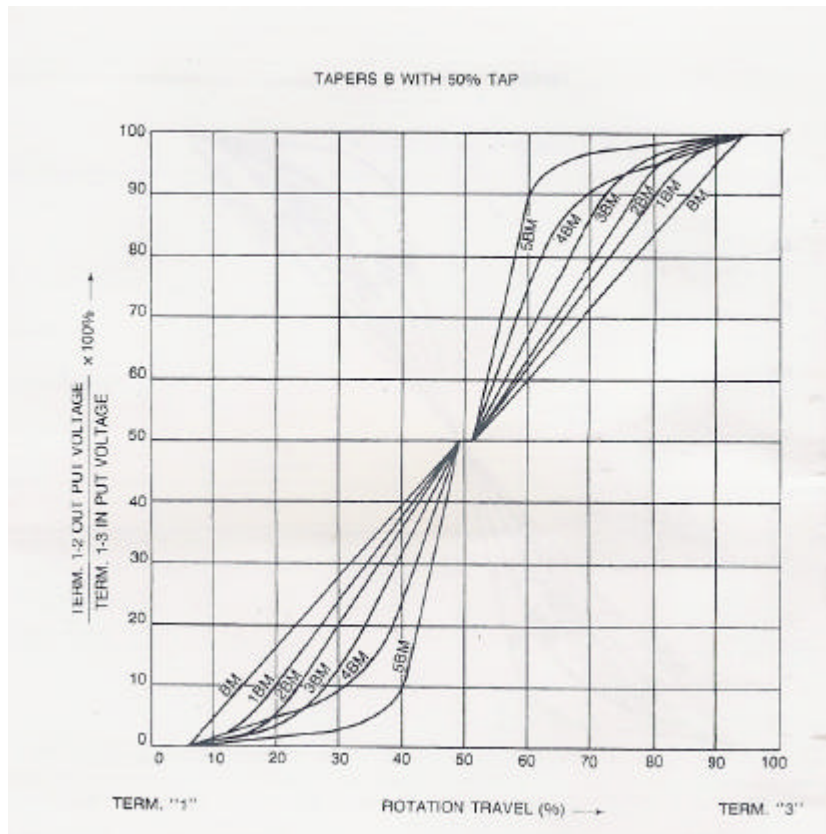
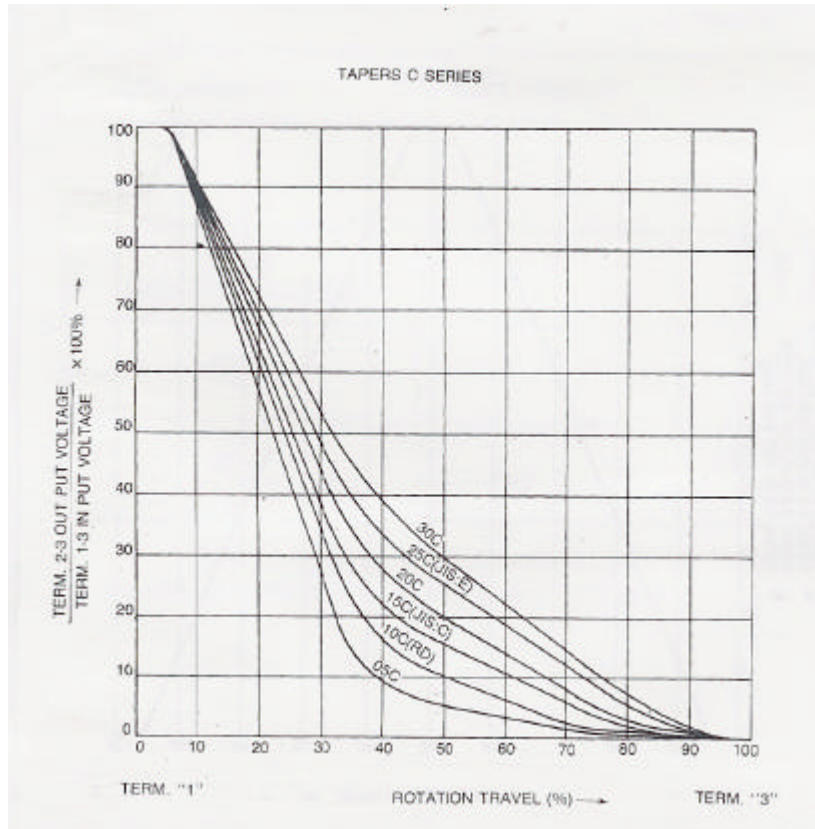

ALPHASTAT 16

TECHNISCHE DATEN - SPECIFICATIONS

Standard Widerstandsnummern—standard resistance tapers

Linear		POS. LOG		NEG. LOG	
FORM	VALUE	FORM	VALUE	FORM	VALUE
B	500R	A		C	
B	1kOhm	A	1kOhm	C	1kOhm
B	2,5kOhm	A	2,5kOhm	C	
B	5kOhm	A	5kOhm	C	5kOhm
B	10kOhm	A	10kOhm	C	10kOhm
B	25kOhm	A	25kOhm	C	
B	50kOhm	A	50kOhm	C	50kOhm
B	100kOh	A	100kOh	C	100kOhm
B	250kOhm	A	250kOhm		

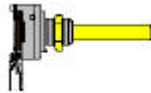

Beispiel: 63250-01400

63250-

Typ/type

Standardausführung/standard

Tragkäfig vorn/with bracket

Tragkäfig stehend/with bracket

Monoausführung-standard

Stereoausführung/2-gang

3 Ebenen/3-gang

4 Ebenen/4-gang

5 Ebenen/5-gang

6 Ebenen/6-gang

M7*0,75 Welle/shaft 4mm L=30

M10*0,75 Welle/shaft 6mm L=30

M7*0,75 Welle/shaft 6mm 18Zähne L=15

Standardausführung ohne Rast/standard

Mittenrast/center click

11 Raststellungen/11 clicks

41 Raststellungen/41 clicks

Ausführung ohne Schalter/standard

Ausführung mit Drehschalter/with pull switch

Ausführung mit Hubschalter/with push switch

0

1

4

0

0

0

1

2

1

2

3

4

5

6

4

6

8

0

1

2

4

0

1

2

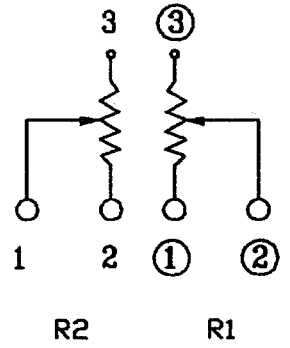
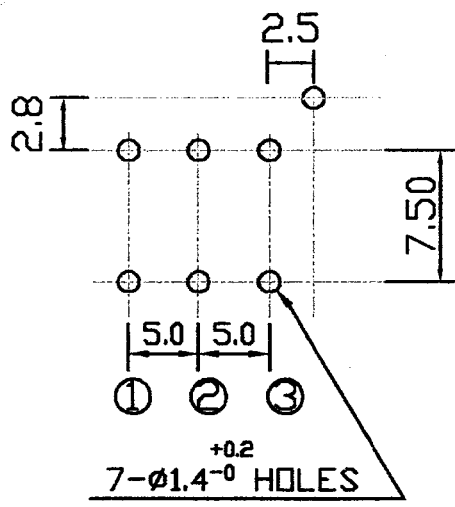
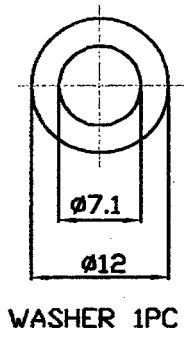
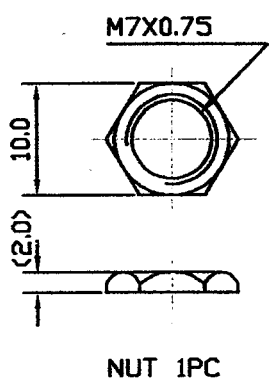
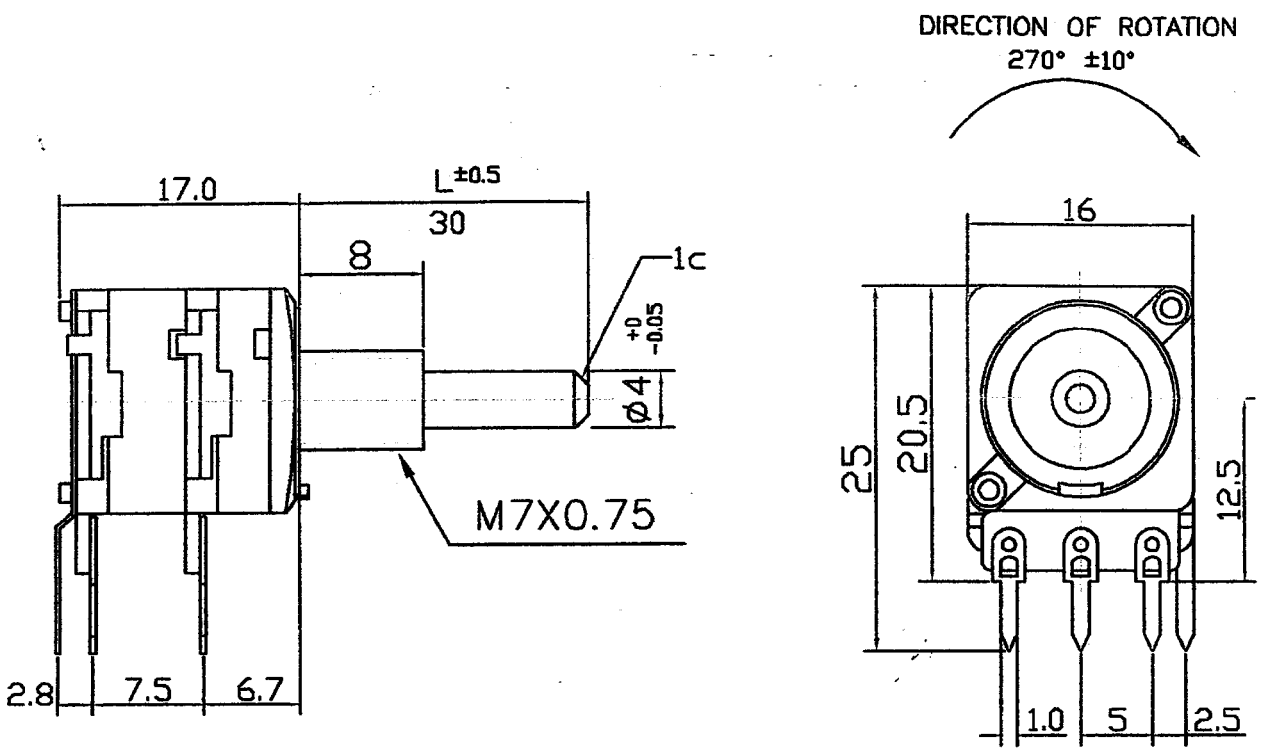

						RD1602-20B4- LR6-XXX-602	
						RD1602-20B4- LR6-XXX-6C2	
No.	DATE	DESCRIPTION	PART No.	NAME			
TOL UNLESS OTHERWISE STATED		DIMENSION	SCALE	DRAWN BY	CHECKED BY	APPROVED BY	DRAWING No.
less than	10	±0.3	mm				
above	10~30	±0.5					
above	30~100	±1.0					
above		±5					