

Metallized Polyester (PET) Capacitors PCM 7.5 mm to 37.5 mm

Special Features

- High volume/capacitance ratio
- Self-healing
- According to RoHS 2002/95/EC

Typical Applications

For general DC-applications e.g.

- By-pass
- Blocking
- Coupling and decoupling
- Timing

Construction

Dielectric:

Polyethylene-terephthalate (PET) film

Capacitor electrodes:

Vacuum-deposited

Internal construction:

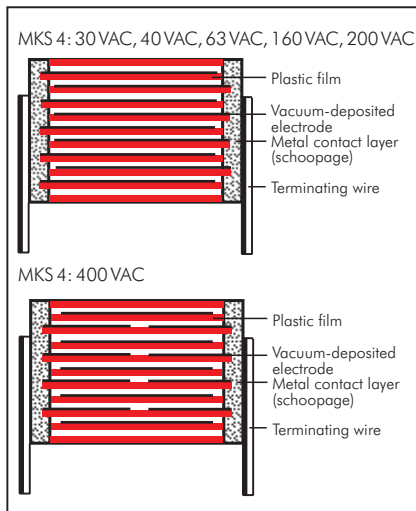

Encapsulation:

Solvent-resistant, flame-retardent plastic case with epoxy resin seal, UL 94 V-0

Terminations:

Tinned wire.

Marking:

Colour: Red. Marking: Black.
Epoxy resin seal: Red

Electrical Data

Capacitance range:

1000 pF to 220 μ F (E12-values on request)

Rated voltages:

50 VDC, 63 VDC, 100 VDC, 250 VDC, 400 VDC, 630 VDC, 1000 VDC, 1500 VDC, 2000 VDC

Capacitance tolerances:

$\pm 20\%$, $\pm 10\%$ $\pm 5\%$

Operating temperature range:

-55° C to $+100^{\circ}$ C

Climatic test category:

55/100/56 in accordance with IEC

Insulation resistance at $+20^{\circ}$ C:

| U_r | U_{test} | $C \leq 0.33 \mu F$ | $0.33 \mu F < C \leq 220 \mu F$ |
|----------------|------------|---|---|
| 50 VDC | 10V | $\geq 5 \times 10^3 M\Omega$ (mean value: $3 \times 10^4 M\Omega$) | ≥ 1500 sec ($M\Omega \times \mu F$) (mean value: 4500 sec) |
| 63 VDC | 50V | $\geq 1 \times 10^4 M\Omega$ (mean value: $5 \times 10^4 M\Omega$) | ≥ 3000 sec ($M\Omega \times \mu F$) (mean value: 6000 sec) |
| 100 VDC | 100V | $\geq 1.5 \times 10^4 M\Omega$ (mean value: $5 \times 10^4 M\Omega$) | ≥ 5000 sec ($M\Omega \times \mu F$) (mean value: 15000 sec) |
| ≥ 250 VDC | 100V | $\geq 3 \times 10^4 M\Omega$ (mean value: $1 \times 10^5 M\Omega$) | ≥ 10000 sec ($M\Omega \times \mu F$) (mean value: 40000 sec) |

Measuring time: 1 min.

Dissipation factors at $+20^{\circ}$ C: $\tan \delta$

| at f | $C \leq 0.1 \mu F$ | $0.1 \mu F < C \leq 1.0 \mu F$ | $C > 1.0 \mu F$ |
|---------|--------------------------|--------------------------------|--------------------------|
| 1 kHz | $\leq 8 \times 10^{-3}$ | $\leq 8 \times 10^{-3}$ | $\leq 10 \times 10^{-3}$ |
| 10 kHz | $\leq 15 \times 10^{-3}$ | $\leq 15 \times 10^{-3}$ | - |
| 100 kHz | $\leq 30 \times 10^{-3}$ | - | - |

Maximum pulse rise time:

| Capacitance pF/ μ F | Pulse rise time V/ μ sec max. operation/test | | | | | | | | |
|----------------------------|---|--------|--------|--------|--------|--------|---------|---------|----------|
| | 50VDC | 63VDC | 100VDC | 250VDC | 400VDC | 630VDC | 1000VDC | 1500VDC | 2000VDC |
| 1000 ... 6800 | - | - | - | - | - | - | 70/700 | 90/900 | 100/1000 |
| 0.01 ... 0.022 | - | 30/300 | 30/300 | 35/350 | 38/380 | 40/400 | 50/500 | 50/500 | 60/600 |
| 0.033 ... 0.068 | - | 15/150 | 15/150 | 20/200 | 25/250 | 32/320 | 26/260 | 35/350 | 40/400 |
| 0.1 ... 0.22 | 10/100 | 10/100 | 12/120 | 15/150 | 15/150 | 17/170 | 20/200 | 35/350 | 40/400 |
| 0.33 ... 0.68 | 9/90 | 9/90 | 9/90 | 10/100 | 10/100 | 13/130 | 20/200 | 20/200 | 38/380 |
| 1.0 ... 2.2 | 6/60 | 6/60 | 5/50 | 6/60 | 9/90 | 13/130 | 14/140 | 15/150 | - |
| 3.3 ... 6.8 | 2.5/25 | 3/30 | 3/30 | 6/60 | 6/60 | 9/90 | 12/120 | - | - |
| 10 ... 220 | 2.5/25 | 2.5/25 | 2.5/25 | 3/30 | 6/60 | - | - | - | - |

for pulses equal to the rated voltage

Mechanical Tests

Pull test on leads:

$d \leq 0.8 \phi$: 10 N in direction of leads
 $d > 0.8 \phi$: 20 N in direction of leads
according to IEC 60068-2-21

Vibration:

6 hours at 10...2000 Hz and 0.75 mm displacement amplitude or 10 g in accordance with IEC 60068-2-6

Low air density:

1kPa = 10 mbar in accordance with IEC 60068-2-13

Bump test: 4000 bumps at 390 m/sec² in accordance with IEC 60068-2-29

Packing

Available taped and reeled up to and including case size 15 x 26 x 31.5 / PCM 27.5 mm.

Detailed taping information and graphs at the end of the catalogue.

For further details and graphs please refer to Technical Information.

Continuation

General Data

| Capacitance | 50 VDC/30 VAC* | | | | 63 VDC/40 VAC* | | | | 100 VDC/63 VAC* | | | | 250 VDC/160 VAC* | | | | 400 VDC/200 VAC* | | | |
|-------------|----------------|------|------|-------|----------------|------|------|-------|-----------------|-----|------|-------|------------------|------|------|-------|------------------|------|------|-------|
| | W | H | L | PCM** | W | H | L | PCM** | W | H | L | PCM** | W | H | L | PCM** | W | H | L | PCM** |
| 0.01 µF | | | | | 2.5 | 7 | 10 | 7.5* | 2.5 | 7 | 10 | 7.5* | 3 | 8.5 | 10 | 7.5* | 3 | 8.5 | 10 | 7.5* |
| 0.015 " | | | | | 4 | 9 | 13 | 10* | 4 | 9 | 13 | 10* | 4 | 9 | 13 | 10* | 4 | 9 | 13 | 10* |
| 0.022 " | | | | | 2.5 | 7 | 10 | 7.5* | 2.5 | 7 | 10 | 7.5* | 3 | 8.5 | 10 | 7.5* | 3 | 8.5 | 10 | 7.5* |
| 0.033 " | | | | | 4 | 9 | 13 | 10* | 4 | 9 | 13 | 10* | 4 | 9 | 13 | 10* | 4 | 9 | 13 | 10* |
| 0.047 " | | | | | 2.5 | 7 | 10 | 7.5* | 2.5 | 7 | 10 | 7.5* | 3 | 8.5 | 10 | 7.5* | 4 | 9 | 10 | 7.5* |
| 0.068 " | | | | | 4 | 9 | 13 | 10* | 4 | 9 | 13 | 10* | 4 | 9 | 13 | 10* | 4 | 9 | 13 | 10* |
| 0.1 µF | 2.5 | 7 | 10 | 7.5 | 2.5 | 7 | 10 | 7.5* | 2.5 | 7 | 10 | 7.5* | 4 | 9 | 10 | 7.5* | 5 | 10.5 | 10.3 | 7.5* |
| 0.15 " | 2.5 | 7 | 10 | 7.5 | 4 | 9 | 13 | 10* | 4 | 9 | 13 | 10* | 4 | 9 | 13 | 10* | 5 | 11 | 13 | 10* |
| 0.22 " | 2.5 | 7 | 10 | 7.5 | 2.5 | 7 | 10 | 7.5* | 3 | 8.5 | 10 | 7.5* | 5 | 10.5 | 10.3 | 7.5* | 5.7 | 12.5 | 10.3 | 7.5* |
| 0.33 " | 2.5 | 7 | 10 | 7.5 | 4 | 9 | 13 | 10* | 4 | 9 | 13 | 10* | 4 | 9 | 13 | 10* | 6 | 12 | 13 | 10* |
| 0.47 " | 3 | 8.5 | 10 | 7.5 | 3 | 8.5 | 10 | 7.5* | 3 | 8.5 | 10 | 7.5* | 5 | 11 | 13 | 10* | 6 | 12.5 | 18 | 15* |
| 0.68 " | 4 | 9 | 10 | 7.5 | 4 | 9 | 13 | 10* | 4 | 9 | 13 | 10* | 5 | 11 | 13 | 10* | 6 | 12.5 | 18 | 15* |
| 1.0 µF | 4 | 9 | 10 | 7.5 | 4 | 9 | 13 | 10* | 4 | 9 | 13 | 10* | 5.7 | 12.5 | 10.3 | 7.5* | 8 | 15 | 18 | 15* |
| 1.5 " | 5 | 10.5 | 10.3 | 7.5 | 5 | 11 | 13 | 10* | 5 | 11 | 13 | 10* | 6 | 15 | 26.5 | 22.5* | 10.5 | 19 | 26.5 | 22.5* |
| 2.2 " | 5.7 | 12.5 | 10.3 | 7.5 | 5.7 | 12.5 | 10.3 | 7.5* | 6 | 12 | 13 | 10* | 6 | 15 | 18 | 15* | 11 | 21 | 31.5 | 27.5* |
| 3.3 " | 5.7 | 12.5 | 10.3 | 7.5 | 6 | 12.5 | 18 | 15* | 6 | 12 | 13 | 10* | 7 | 14 | 18 | 15* | 11 | 21 | 26.5 | 22.5* |
| 4.7 " | 7.2 | 12.5 | 10.3 | 7.5* | 6 | 12 | 13 | 10* | 7 | 14 | 18 | 15* | 8 | 15 | 18 | 15* | 11 | 21 | 26.5 | 22.5* |
| 6.8 " | 6 | 12 | 13 | 10* | 7 | 14 | 18 | 15* | 7 | 14 | 18 | 15* | 7 | 14 | 18 | 15* | 11 | 21 | 26.5 | 22.5* |
| 10 µF | 9 | 16 | 18 | 15 | 7 | 14 | 18 | 15* | 8 | 15 | 18 | 15* | 10.5 | 19 | 26.5 | 22.5* | 13 | 24 | 31.5 | 27.5 |
| 15 " | 11 | 21 | 26.5 | 22.5 | 6 | 15 | 26.5 | 22.5* | 9 | 16 | 18 | 15* | 11 | 21 | 26.5 | 22.5* | 13 | 24 | 31.5 | 27.5 |
| 22 " | 11 | 21 | 31.5 | 27.5 | 7 | 14 | 18 | 15* | 11 | 21 | 26.5 | 22.5* | 11 | 21 | 26.5 | 22.5* | 17 | 29 | 31.5 | 27.5 |
| 33 " | 13 | 24 | 31.5 | 27.5 | 8 | 15 | 18 | 15* | 11 | 21 | 26.5 | 22.5* | 11 | 21 | 26.5 | 22.5* | 17 | 29 | 31.5 | 27.5 |
| 47 " | 15 | 26 | 31.5 | 27.5* | 9 | 16 | 18 | 15* | 11 | 21 | 26.5 | 22.5* | 11 | 21 | 26.5 | 22.5* | 17 | 29 | 31.5 | 27.5 |
| 68 " | 13 | 24 | 41.5 | 37.5* | 10* | 6 | 15 | 26.5 | 10.5 | 19 | 26.5 | 22.5* | 11 | 21 | 26.5 | 22.5* | 17 | 29 | 31.5 | 27.5 |
| 100 µF | 19 | 32 | 41.5 | 37.5 | 10* | 6 | 15 | 26.5 | 10.5 | 19 | 26.5 | 22.5* | 13 | 24 | 31.5 | 27.5 | 17 | 29 | 31.5 | 27.5 |
| 150 " | 20 | 39.5 | 41.5 | 37.5 | 10* | 7 | 16.5 | 26.5 | 11 | 21 | 31.5 | 27.5* | 13 | 24 | 31.5 | 27.5 | 17 | 29 | 31.5 | 27.5 |
| 220 " | 24 | 45.5 | 41.5 | 37.5 | 10* | 7 | 16.5 | 26.5 | 11 | 21 | 31.5 | 27.5* | 13 | 24 | 31.5 | 27.5 | 17 | 29 | 31.5 | 27.5 |

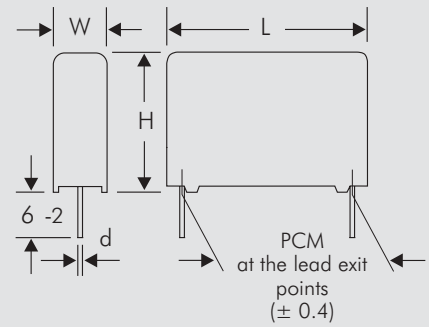

* AC voltage: $f = 50 \text{ Hz}$; $1.4 \times U_{\text{rms}} + U_{\text{DC}} \leq U_r$

** PCM = Printed circuit module = lead spacing

* On ordering please state the required PCM (lead spacing)!
If not specified, smaller PCM will be booked.

Dims. in mm.

Taped version see page 104.

Rights reserved to amend design data without prior notification.

| ∅ d | PCM | W |
|-----|-----------|-----|
| 0.5 | 7.5 | ≤ 3 |
| 0.6 | 7.5 | ≥ 4 |
| 0.6 | 10 | |
| 0.8 | 15 - 27.5 | |
| 1.0 | 37.5 | |

Continuation

General Data

| Capacitance | 630 VDC/400 VAC* | | | | 1000 VDC/400 VAC* | | | | 1500 VDC/400 VAC* | | | | 2000 VDC/400 VAC* | | | |
|-------------|------------------|------|------|-------|-------------------|------|------|-------|-------------------|------|------|-------|-------------------|------|------|-------|
| | W | H | L | PCM** | W | H | L | PCM** | W | H | L | PCM** | W | H | L | PCM** |
| 1000 pF | | | | | 3 | 8.5 | 10 | 7.5* | 4 | 9 | 13 | 10 | 4 | 9 | 13 | 10 |
| 1500 " | | | | | 3 | 8.5 | 10 | 7.5* | 4 | 9 | 13 | 10 | 4 | 9 | 13 | 10 |
| 2200 " | | | | | 3 | 8.5 | 10 | 7.5* | 4 | 9 | 13 | 10 | 5 | 11 | 13 | 10 |
| 3300 " | | | | | 4 | 9 | 10 | 7.5* | 4 | 9 | 13 | 10 | 6 | 12 | 13 | 10* |
| 4700 " | | | | | 4 | 9 | 13 | 10* | 4 | 9 | 13 | 10* | 5 | 11 | 18 | 15* |
| 6800 " | | | | | 4 | 9 | 10 | 7.5* | 4 | 9 | 13 | 10* | 5 | 11 | 18 | 15 |
| | | | | | 4 | 9 | 13 | 10* | 5 | 11 | 18 | 15* | 5 | 11 | 18 | 15* |
| 0.01 µF | 3 | 8.5 | 10 | 7.5** | 5 | 10.5 | 10.3 | 7.5* | 6 | 12 | 13 | 10* | 7 | 14 | 18 | 15* |
| 0.015 " | 4 | 9 | 13 | 10* | 5 | 11 | 13 | 10* | 5 | 11 | 18 | 15* | 6 | 15 | 26.5 | 22.5* |
| 0.022 " | 4 | 9 | 13 | 10* | 5.7 | 12.5 | 10.3 | 7.5* | 6 | 12.5 | 18 | 15 | 6 | 15 | 26.5 | 22.5 |
| 0.033 " | 4.5 | 9.5 | 10.3 | 7.5** | 6 | 12 | 13 | 10* | 6 | 12 | 13 | 10* | 7 | 16.5 | 26.5 | 22.5 |
| 0.047 " | 5 | 10.5 | 10.3 | 7.5** | 5 | 11 | 18 | 15 | 7 | 14 | 18 | 15* | 7 | 16.5 | 26.5 | 22.5 |
| 0.068 " | 5 | 11 | 13 | 10* | 6 | 12.5 | 18 | 15* | 6 | 15 | 26.5 | 22.5* | 6 | 15 | 26.5 | 22.5* |
| | 5.7 | 12.5 | 10.3 | 7.5** | 6 | 15 | 26.5 | 22.5* | 6 | 15 | 26.5 | 22.5* | 7 | 16.5 | 26.5 | 22.5 |
| | 6 | 12 | 13 | 10* | 7 | 14 | 18 | 15* | 7 | 16.5 | 26.5 | 22.5 | 11 | 21 | 26.5 | 22.5* |
| | 6 | 12 | 13 | 10* | 6 | 15 | 26.5 | 22.5* | 8 | 15 | 18 | 15* | 11 | 21 | 31.5 | 27.5* |
| | 5 | 11 | 18 | 15* | 6 | 15 | 26.5 | 22.5* | 8.5 | 18.5 | 26.5 | 22.5 | 11 | 21 | 31.5 | 27.5 |
| 0.1 µF | 6 | 12.5 | 18 | 15* | 9 | 16 | 18 | 15* | 10.5 | 19 | 26.5 | 22.5* | 13 | 24 | 31.5 | 27.5 |
| 0.15 " | 6 | 15 | 26.5 | 22.5* | 7 | 16.5 | 26.5 | 22.5* | 9 | 19 | 31.5 | 27.5* | 17 | 29 | 31.5 | 27.5* |
| 0.22 " | 7 | 14 | 18 | 15* | 8.5 | 18.5 | 26.5 | 22.5 | 11 | 21 | 31.5 | 27.5 | 13 | 24 | 41.5 | 37.5* |
| 0.33 " | 6 | 15 | 26.5 | 22.5* | 10.5 | 19 | 26.5 | 22.5 | 13 | 24 | 31.5 | 27.5 | 17 | 29 | 41.5 | 37.5 |
| 0.47 " | 8 | 15 | 18 | 15* | 11 | 21 | 26.5 | 22.5* | 17 | 34.5 | 31.5 | 27.5* | 20 | 39.5 | 41.5 | 37.5 |
| 0.68 " | 7 | 16.5 | 26.5 | 22.5* | 11 | 21 | 31.5 | 27.5* | 17 | 29 | 41.5 | 37.5* | 24 | 45.5 | 41.5 | 37.5 |
| | 9 | 19 | 31.5 | 27.5* | 13 | 24 | 31.5 | 27.5 | 20 | 39.5 | 31.5 | 27.5* | | | | |
| 1.0 µF | 10.5 | 19 | 26.5 | 22.5* | 13 | 24 | 31.5 | 27.5 | 20 | 39.5 | 31.5 | 27.5* | | | | |
| 1.5 " | 9 | 19 | 31.5 | 27.5* | 15 | 26 | 31.5 | 27.5 | 20 | 39.5 | 41.5 | 37.5 | | | | |
| 2.2 " | 11 | 21 | 26.5 | 22.5* | 17 | 29 | 31.5 | 27.5* | 24 | 45.5 | 41.5 | 37.5 | | | | |
| 3.3 " | 11 | 21 | 31.5 | 27.5* | 17 | 29 | 41.5 | 37.5* | | | | | | | | |
| 4.7 " | 15 | 26 | 31.5 | 27.5 | 19 | 32 | 41.5 | 37.5 | | | | | | | | |
| 6.8 " | 17 | 34.5 | 31.5 | 27.5* | 20 | 39.5 | 41.5 | 37.5 | | | | | | | | |
| | 15 | 26 | 41.5 | 37.5* | | | | | | | | | | | | |
| | 20 | 39.5 | 31.5 | 27.5* | | | | | | | | | | | | |
| | 19 | 32 | 41.5 | 37.5* | | | | | | | | | | | | |
| | 20 | 39.5 | 41.5 | 37.5 | | | | | | | | | | | | |
| | 24 | 45.5 | 41.5 | 37.5 | | | | | | | | | | | | |

* AC voltage: $f = 50 \text{ Hz}; 1.4 \times U_{\text{rms}} + U_{\text{DC}} \leq U_r$

** PCM = Printed circuit module = lead spacing

* On ordering please state the required PCM (lead spacing)!
If not specified, smaller PCM will be booked.

** Admissible AC voltage 250 VAC max.

Dims. in mm.

Taped version see page 104.

| ∅ d | PCM | W |
|-----|-----------|-----|
| 0.5 | 7.5 | ≤ 3 |
| 0.6 | 7.5 | ≥ 4 |
| 0.6 | 10 | |
| 0.8 | 15 - 27.5 | |
| 1.0 | 37.5 | |

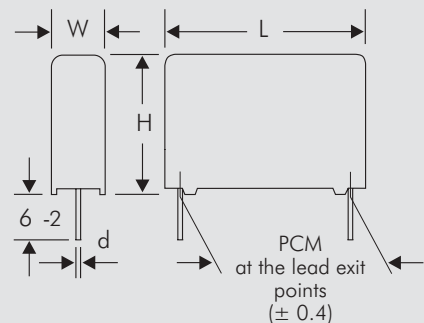

Rights reserved to amend design data without prior notification.

WIMA MKP 4



Continuation

Permissible AC voltage in relation to frequency at 10° C internal temperature rise (general guide).

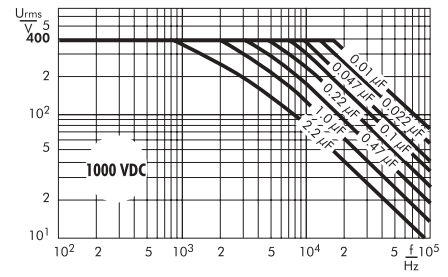
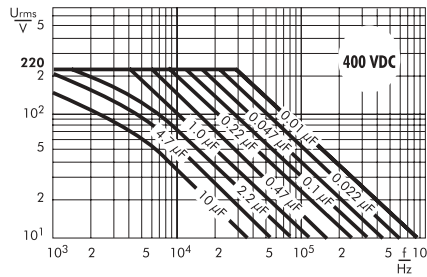
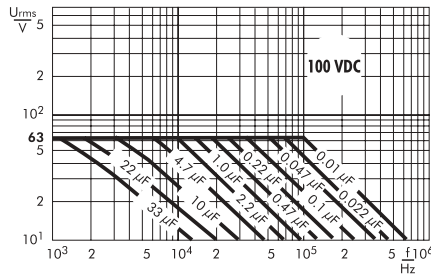
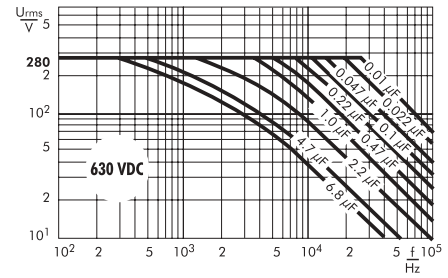
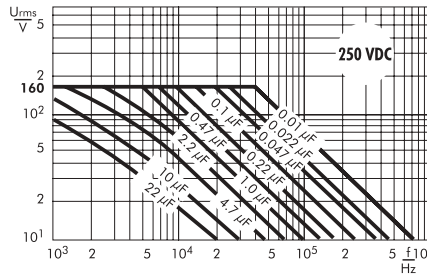

WIMA MKS 4

Permissible AC voltage in relation to frequency at 10° C internal temperature rise (general guide).

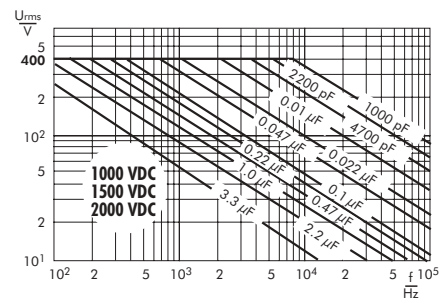
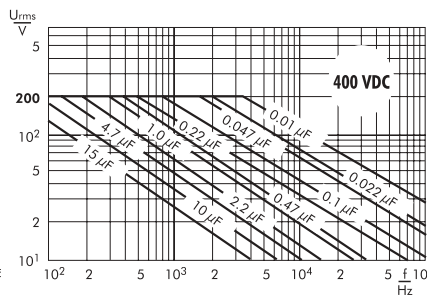
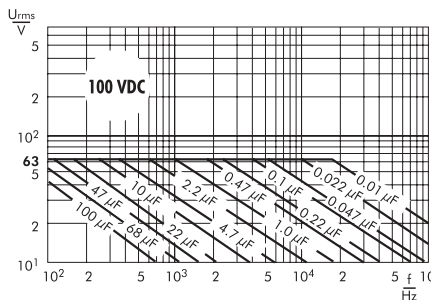
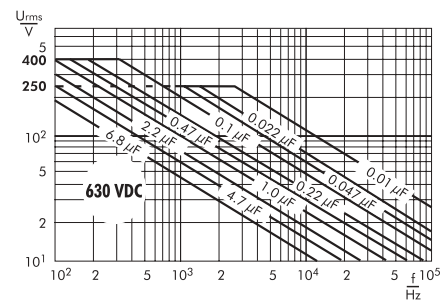
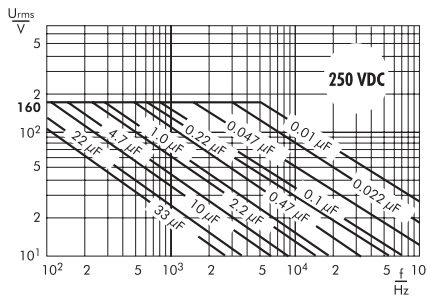
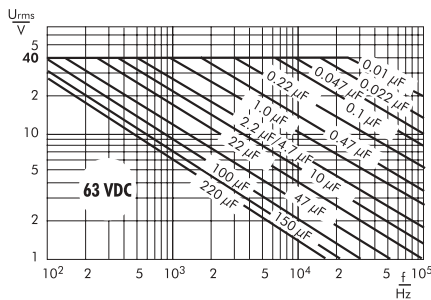

Technical information and general data see page 57.

Recommendation for Processing and Application of Through-Hole Capacitors

Soldering Process

A preheating of through-hole WIMA capacitors is allowed for temperatures $T_{max} < 100^{\circ}C$.
In practice a preheating duration of $t < 5$ min. has been proven to be best.

Single wave soldering

Soldering bath temperature: $T < 260^{\circ}C$
Immersion time: $t < 5$ sec

Double wave soldering

Soldering bath temperature: $T < 260^{\circ}C$
Immersion time: $2 \times t < 3$ sec

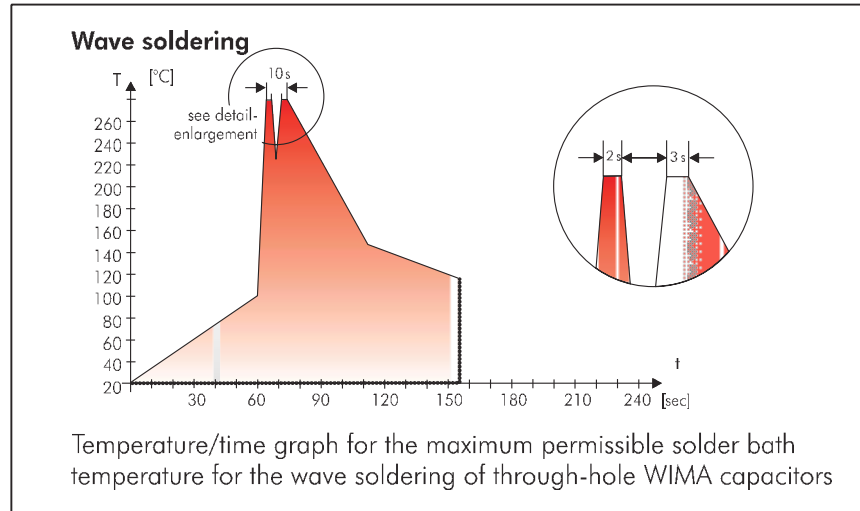

WIMA Quality and Environmental Philosophy

ISO 9001:2000 Certification

ISO 9001:2000 is an international basic standard of quality assurance systems for all branches of industry. The approval according to ISO 9001:2000 of our factories by the VDE inspectorate certifies that organisation, equipment and monitoring of quality assurance in our factories correspond to internationally recognized standards.

WIMA WPCS

The WIMA Process Control System (WPCS) is a quality surveillance and optimization system developed by WIMA. WPCS is a major part of the quality-oriented WIMA production. Points of application of WPCS during production process:

- incoming material inspection
- metallization
- film inspection
- schoopage
- pre-healing
- lead attachment
- cast resin preparation/encapsulation
- 100% final inspection
- AQL check

WIMA Environmental Policy

All WIMA capacitors, irrespective of whether through-hole devices or SMD, are made of environmentally friendly materials. Neither during manufacture nor in the product itself any toxic substances are used, e.g.

- | | |
|------------------------|------------|
| - Lead | - PBB/PBDE |
| - PCB | - Arsenic |
| - CFC | - Cadmium |
| - Hydrocarbon chloride | - Mercury |
| - Chromium 6+ | - etc. |

We merely use pure, recyclable materials for packing our components, such as:

- carton
- cardboard
- adhesive tape made of paper
- polystyrene

We almost completely refrain from using packing materials such as:

- foamed polystyrene (Styropor®)
- adhesive tapes made of plastic
- metal clips

RoHS Compliance

According to the RoHS Directive 2002/95/EC certain hazardous substances like e.g. lead, cadmium, mercury must not be used any longer in electronic equipment as of July 1st, 2006. For the sake of the environment WIMA has refrained from using such substances since years already.



WIMA Kondensatoren sind bleifrei konform RoHS 2002/95/EG

WIMA capacitors are lead free in accordance with RoHS 2002/95/EC

Tape for lead-free WIMA capacitors

DIN EN ISO 14001:2005

WIMA's environmental management has been established in accordance with the guidelines of DIN EN ISO 14001:2005. The certification has been granted in June 2006.

Typical Dimensions for Taping Configuration

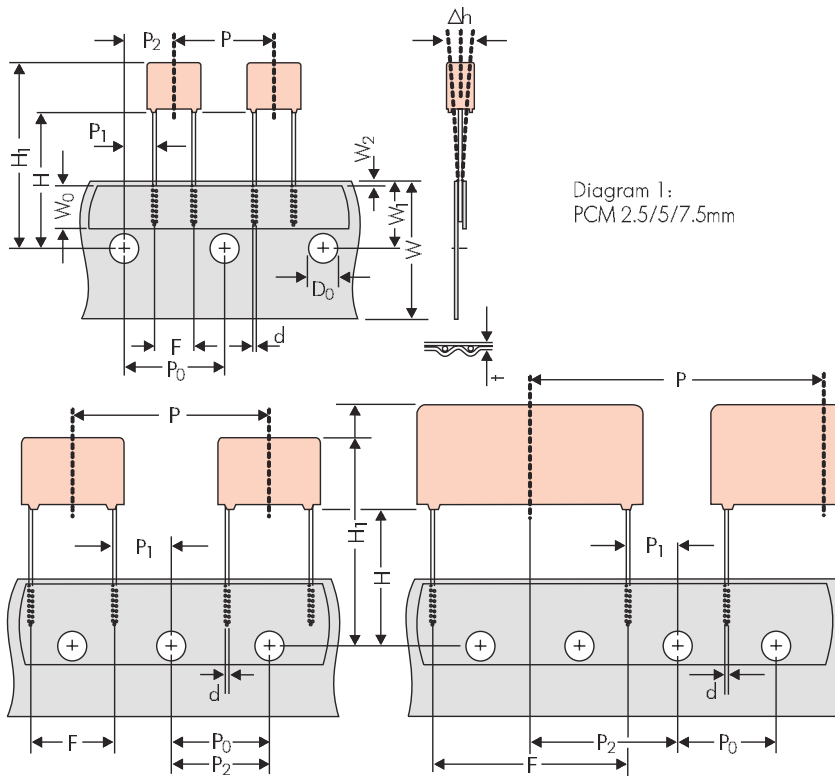

Diagram 2: PCM 10/15 mm

Diagram 3: PCM 22.5 and 27.5*mm

*PCM 27.5 taping possible with two feed holes between components

| Designation | Symbol | Dimensions for Radial Taping | | | | | | |
|--|----------------|--|--|---|---|---|---|---|
| | | PCM 2.5 taping | PCM 5 taping | PCM 7.5 taping | PCM 10 taping* | PCM 15 taping* | PCM 22.5 taping | PCM 27.5 taping |
| Carrier tape width | W | 18.0 ±0.5 | 18.0 ±0.5 | 18.0 ±0.5 | 18.0 ±0.5 | 18.0 ±0.5 | 18.0 ±0.5 | 18.0 ±0.5 |
| Hold-down tape width | W ₀ | 6.0 for hot-sealing adhesive tape | 6.0 for hot-sealing adhesive tape | 12.0 for hot-sealing adhesive tape | 12.0 for hot-sealing adhesive tape | 12.0 for hot-sealing adhesive tape | 12.0 for hot-sealing adhesive tape | 12.0 for hot-sealing adhesive tape |
| Hole position | W ₁ | 9.0 ±0.5 | 9.0 ±0.5 | 9.0 ±0.5 | 9.0 ±0.5 | 9.0 ±0.5 | 9.0 ±0.5 | 9.0 ±0.5 |
| Hold-down tape position | W ₂ | 0.5 to 3.0 max. | 0.5 to 3.0 max. | 0.5 to 3.0 max. | 0.5 to 3.0 max. | 0.5 to 3.0 max. | 0.5 to 3.0 max. | 0.5 to 3.0 max. |
| Feed hole diameter | D ₀ | 4.0 ±0.2 | 4.0 ±0.2 | 4.0 ±0.2 | 4.0 ±0.2 | 4.0 ±0.2 | 4.0 ±0.2 | 4.0 ±0.2 |
| Pitch of component | P | 12.7 ±1.0 | 12.7 ±1.0 | 12.7 ±1.0 | 25.4 ±1.0 | 25.4 ±1.0 | 38.1 ±1.5 | 38.1 ±1.5 or 50.8 ±1.5 |
| Feed hole pitch | P ₀ | 12.7 ±0.3 cumulative pitch error max. 1.0 mm/20 pitch | 12.7 ±0.3 cumulative pitch error max. 1.0 mm/20 pitch | 12.7 ±0.3 cumulative pitch error max. 1.0 mm/20 pitch | 12.7 ±0.3 cumulative pitch error max. 1.0 mm/20 pitch | 12.7 ±0.3 cumulative pitch error max. 1.0 mm/20 pitch | 12.7 ±0.3 cumulative pitch error max. 1.0 mm/20 pitch | 12.7 ±0.3 cumulative pitch error max. 1.0 mm/20 pitch |
| Feed hole centre to lead | P ₁ | 5.1 ±0.5 | 3.85 ±0.7 | 2.6 ±0.7 | 7.7 ±0.7 | 5.2 ±0.7 | 7.8 ±0.7 | 5.3 ±0.7 |
| Hole centre to component centre | P ₂ | 6.35 ±1.3 | 6.35 ±1.3 | 6.35 ±1.3 | 12.7 ±1.3 | 12.7 ±1.3 | 19.05 ±1.3 | 19.05 ±1.3 |
| Feed hole centre to bottom edge of the component | H [▲] | 16.5 ±0.3 18.5 ±0.5 | 16.5 ±0.3 18.5 ±0.5 | 16.5 ±0.5 18.5 ±0.5 | 16.5 ±0.5 18.5 ±0.5 | 16.5 ±0.5 18.5 ±0.5 | 16.5 ±0.5 18.5 ±0.5 | 16.5 ±0.5 18.5 ±0.5 |
| Feed hole centre to top edge of the component | H ₁ | H+H _{component} < H ₁ 32.25 max. | H+H _{component} < H ₁ 32.25 max. | H+H _{component} < H ₁ 24.5 to 31.5 | H+H _{component} < H ₁ 25.0 to 31.5 | H+H _{component} < H ₁ 26.0 to 37.0 | H+H _{component} < H ₁ 30.0 to 43.0 | H+H _{component} < H ₁ 35.0 to 45.0 |
| Lead spacing at upper edge of carrier tape | F | 2.5 ±0.5 | 5.0 ^{+0.3} _{-0.2} | 7.5 ±0.8 | 10.0 ±0.8 | 15 ±0.8 | 22.5 ±0.8 | 27.5 ±0.8 |
| Lead diameter | d | 0.4 ±0.05 | 0.5 ±0.05 | 0.5 ±0.05 or 0.6 ^{+0.06} _{-0.05} | 0.5 ±0.05 or 0.6 ^{+0.06} _{-0.05} | 0.8 ^{+0.08} _{-0.05} | 0.8 ^{+0.08} _{-0.05} | 0.8 ^{+0.08} _{-0.05} |
| Component alignment | Δh | ± 2.0 max. | ± 2.0 max. | ± 3.0 max. | ± 3.0 max. | ± 3.0 max. | ± 3.0 max. | ± 3.0 max. |
| Total tape thickness | t | 0.7 ±0.2 | 0.7 ±0.2 | 0.7 ±0.2 | 0.7 ±0.2 | 0.7 ±0.2 | 0.7 ±0.2 | 0.7 ±0.2 |
| Package (see also page 1051) | ▲ | ROLL/AMMO | | | AMMO | | | |
| | | REEL ø 360 max. ø 30 ±1 | B 52 ±2 58 ±2 | } depending on compo. dimensions | REEL ø 360 max. ø 30 ±1 | B 52 ±2 58 ±2 or 66 ±2 | REEL ø 500 max. ø 25 ±1 | B 54 ±2 60 ±2 68 ±2 |
| Unit see details page 107. | | | | | | | | |

▲ Please give „H“ dimensions and desired packaging type when ordering.

▪ Diameter of leads see General Data.

* PCM 10 and PCM 15 can be crimped to PCM 7.5.

Position of components according to PCM 7.5 sketch 11. P₀ = 12.7 or 15.0 is possible

Dim's in mm.

Please clarify customer-specific deviations with the manufacturer.