

Metal Alloy Low-Resistance Resistor Specifications

1 Scope:

This specification is applicable to lead free and halogen free for metal alloy low-resistance resistor by following products:

- LR1206 series
- LR2010 series
- LR2512 series
- LR2725 series
- LR2728 series
- LR4527 series

2 Explanation Of Part Numbers:

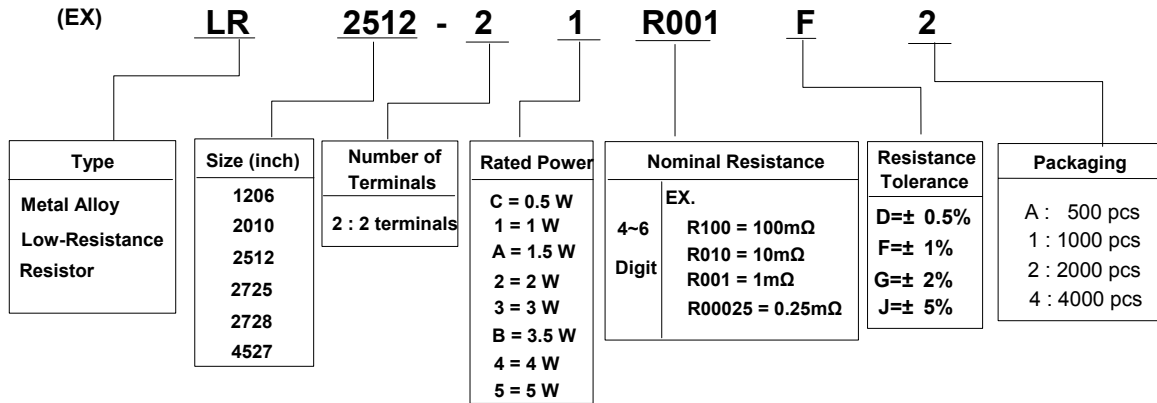

Approved

Checked

Written

Remark

IT'S NOT UNDER CONTROL FOR PDF FILE
PLS NOTE THE VERSION STATED.

Issue Dep. DATA Center.

Do not copy without permission

Series No. **60**

3 Product Specifications:

Type	Number of Terminals	Rated Power at 70°C	Max. Rated Current	Max. Overload Current	T.C.R (ppm / °C)	Resistance Range		Operating Temperature Range
						D(± 0.5%)	F(± 1%)、G(± 2%) J(± 5%)	
LR1206	2	0.5 W	22.36 A	44.72 A	1 ~ 4 mΩ ≤± 50 4.1 ~ 15 mΩ ≤± 25 15.1 ~ 50 mΩ ≤± 15	7 ~ 50 mΩ	1 ~ 50 mΩ	-55°C ~ +170°C
		1 W	31.62 A	63.25 A	1 ~ 4 mΩ ≤± 50 4.1 ~ 15 mΩ ≤± 25 15.1 ~ 50 mΩ ≤± 15	7 ~ 50 mΩ	1 ~ 50 mΩ	
LR2010	2	1 W	31.62 A	63.25 A	1 ~ 3 mΩ ≤± 50 3.1 ~ 6.9 mΩ ≤± 25 7 ~ 100 mΩ ≤± 15	7 ~ 100 mΩ	1 ~ 100 mΩ	
LR2512	2	1 W	44.72 A	100.00 A	0.5 ~ 3 mΩ ≤± 50 3.1 ~ 6.9 mΩ ≤± 25 7 ~ 100 mΩ ≤± 15	7 ~ 100 mΩ	0.5 ~ 100 mΩ	
		1.5 W	54.77 A	122.48 A	0.5 ~ 3 mΩ ≤± 50 3.1 ~ 6.9 mΩ ≤± 25 7 ~ 75 mΩ ≤± 15	7 ~ 75 mΩ	0.5 ~ 75 mΩ	
		2 W	63.25 A	141.42 A	0.5 ~ 2.5 mΩ ≤± 50 2.6 ~ 10 mΩ ≤± 25	7 ~ 10 mΩ	0.5 ~ 10 mΩ	
		3 W	77.46 A	134.16 A	0.5 ~ 2.5 mΩ ≤± 50 2.6 ~ 10 mΩ ≤± 25	7 ~ 10 mΩ	0.5 ~ 10 mΩ	
LR2725	2	4 W	126.49 A	252.95 A	≤± 50	--	0.25 ~ 3 mΩ	
LR2728	2	3 W	27.39 A	47.43 A	4 ~ 7 mΩ ≤± 25 7.1 ~ 100 mΩ ≤± 15	4 ~ 100 mΩ		
		3.5 W	29.58 A	51.23 A	4 ~ 7 mΩ ≤± 25 7.1 ~ 50 mΩ ≤± 15	4 ~ 50 mΩ		
		4 W	31.62 A	63.25 A	4 ~ 7 mΩ ≤± 25 7.1 ~ 50 mΩ ≤± 15	4 ~ 50 mΩ		
LR4527	2	3 W	77.5A	134A	≤± 50	7 ~ 120 mΩ	0.5 ~ 120 mΩ	
		5 W	100A	173A				

Remark

IT' S NOT UNDER CONTROL FOR PDF FILE
PLS NOTE THE VERSION STATED.

Issue Dep. DATA Center.

Do not copy without permission

Series No. **60**

Metal Alloy Low-Resistance Resistor Specifications

Document No.	IE-SP-022
Released Date	2011/10/19
Page No.	3/13

3.1 Power Derating Curve: Operating Temperature Range : - 55 ~+170 °C
 For resistors operated in ambient temperatures above 70 °C, power rating shall be derated in accordance with figure below.

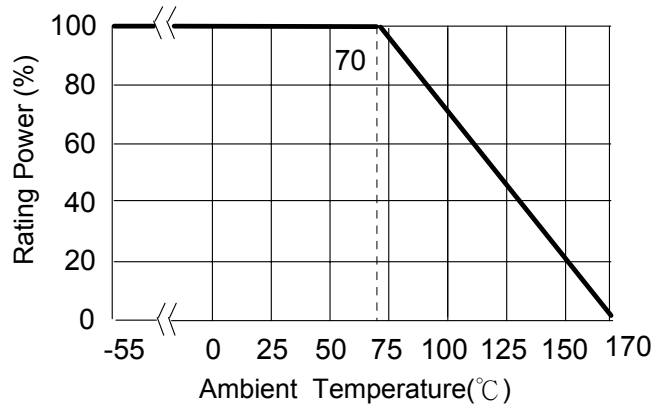

3.2 Rating Current:

Rated Current: The resistor shall have a DC continuous working current or a RMS(Root Mean Square). AC continuous working current at commercial-line frequency and wave form corresponding to the power rating, as determined from the following:

$$I = \sqrt{P/R}$$

I= Rating current (A)
 P= Rating power (w)
 R= Nominal resistance (Ω)

Metal Alloy Low-Resistance Resistor Specifications

4 Dimensions:

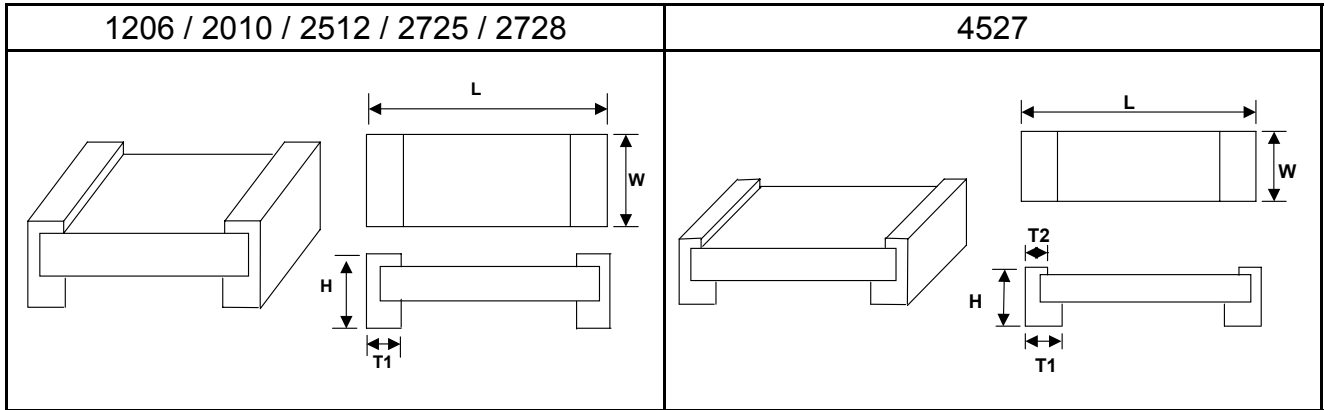

TYPE	Power Rating (W)	Resistance Range (mΩ)	Dimensions (mm)				
			L	W	H	T1	T2
LR1206	0.5 1	1~50	3.200± 0.254	1.600± 0.254	0.645± 0.254	0.508± 0.254	
LR2010	1	1.0~3	5.080± 0.254	2.540± 0.254	0.787± 0.254	1.295± 0.254	
		3.1~100			0.645± 0.254	0.787± 0.254	
LR2512	1 1.5	0.5~4	6.248± 0.254	3.302± 0.254	0.787± 0.254	1.880± 0.254	
		4.1~75			0.645± 0.254	1.118± 0.254	
		75.1~100			0.645± 0.254	0.868± 0.254	
	2	0.5~4			0.787± 0.254	1.880± 0.254	
		4.1~75			0.645± 0.254	1.118± 0.254	
	3	0.5				1.880± 0.254	
		0.6~2.9			0.787± 0.254	1.118± 0.254	
		4.1~10				1.676± 0.254	
LR2725	4	0.25、0.5	6.807± 0.254	6.452± 0.254	0.991± 0.254	2.159± 0.254	
		1			1.092± 0.254		
		1.5			0.991± 0.254		
		2				1.803± 0.254	
		2.5			0.889± 0.254	1.651± 0.254	
		3				1.295± 0.254	
LR2728	3 3.5 4	4~100	6.706± 0.254	7.188± 0.254	0.991± 0.254	1.143± 0.254	
LR4527	3 5	0.5	11.430± 0.254	6.850± 0.254	1.500± 0.254	3.215±0.254	3.215±0.254
		0.6~5.0					0.965±0.254
		5.1~120				1.815±0.254	

Remark

IT' S NOT UNDER CONTROL FOR PDF FILE
PLS NOTE THE VERSION STATED.

Issue Dep. DATA Center.

Do not copy without permission

Series No. 60

5 Reliability Performance Test

5.1 Electrical Performance Test

Item	Conditions	Specifications																												
Temperature Coefficient of Resistance	$TCR (ppm/^{\circ}C) = \frac{(R2 - R1)}{R1 (T2 - T1)} \times 10^6$ R1: Resistance at room temperature R2: Resistance at +150°C T1: Room temperature T2: Temperature at +150°C Refer to JIS-C5201-1 4.8	Refer to Paragraph 3. general specifications																												
Short Time Overload	Applied Overload for 5 seconds and release the load for about 30 minutes , then measure its resistance variance rate. (Overload condition refer to below) <table border="1" style="margin-top: 10px;"> <thead> <tr> <th>Type</th> <th>Overload</th> </tr> </thead> <tbody> <tr><td>LR1206-0.5W</td><td>4 times of rated power</td></tr> <tr><td>LR1206-1W</td><td>4 times of rated power</td></tr> <tr><td>LR2010-1W</td><td>4 times of rated power</td></tr> <tr><td>LR2512-1W</td><td>5 times of rated power</td></tr> <tr><td>LR2512-1.5W</td><td>5 times of rated power</td></tr> <tr><td>LR2512-2W</td><td>5 times of rated power</td></tr> <tr><td>LR2512-3W</td><td>3 times of rated power</td></tr> <tr><td>LR2725-4W</td><td>4 times of rated power</td></tr> <tr><td>LR2728-3W</td><td>3 times of rated power</td></tr> <tr><td>LR2728-3.5W</td><td>3 times of rated power</td></tr> <tr><td>LR2728-4W</td><td>4 times of rated power</td></tr> <tr><td>LR4527-3W</td><td>3 times of rated power</td></tr> <tr><td>LR4527-5W</td><td>3 times of rated power</td></tr> </tbody> </table> Refer to JIS-C5201-1 4.13	Type	Overload	LR1206-0.5W	4 times of rated power	LR1206-1W	4 times of rated power	LR2010-1W	4 times of rated power	LR2512-1W	5 times of rated power	LR2512-1.5W	5 times of rated power	LR2512-2W	5 times of rated power	LR2512-3W	3 times of rated power	LR2725-4W	4 times of rated power	LR2728-3W	3 times of rated power	LR2728-3.5W	3 times of rated power	LR2728-4W	4 times of rated power	LR4527-3W	3 times of rated power	LR4527-5W	3 times of rated power	$\leq \pm 0.5\%$ $\leq \pm 2.0\%$ (4527-3W & 4527-5W) No evidence of mechanical damage.
Type	Overload																													
LR1206-0.5W	4 times of rated power																													
LR1206-1W	4 times of rated power																													
LR2010-1W	4 times of rated power																													
LR2512-1W	5 times of rated power																													
LR2512-1.5W	5 times of rated power																													
LR2512-2W	5 times of rated power																													
LR2512-3W	3 times of rated power																													
LR2725-4W	4 times of rated power																													
LR2728-3W	3 times of rated power																													
LR2728-3.5W	3 times of rated power																													
LR2728-4W	4 times of rated power																													
LR4527-3W	3 times of rated power																													
LR4527-5W	3 times of rated power																													
Insulation Resistance	Put the resistor in the fixture, add 100 VDC in + , - terminal for 60secs then measured the insulation resistance between electrodes and insulating enclosure or between electrodes and base material. Refer to JIS-C5201-1 4.6	$\geq 10^9 \Omega$																												
Dielectric Withstand Voltage	Applied 500VAC for 1 minute, and Limit surge current 50 mA (max.) Refer to JIS-C5201-1 4.7	No short or burned on the appearance.																												

Remark

IT'S NOT UNDER CONTROL FOR PDF FILE
PLS NOTE THE VERSION STATED.

Issue Dep. **DATA Center.**

Do not copy without permission

Series No. **60**

5.2 Mechanical Performance Test

Item	Conditions	Specifications
Solderability	Add flux into tested resistors, immersion into solder bath in temperature 245± 5°C for 3 ± 0.5 secs. Refer to JIS-C5201-1 4.17	Solder coverage over 95%
Resistance to Solvent	The tested resistor be immersed into isopropyl alcohol of 20~25°C for 60 secs, then the resistor is left in the room for 48 hrs. Refer to JIS-C5201-1 4.29	≤± 0.5% No evidence of mechanical damage.
Resistance to Soldering Heat	The tested resistor be immersed 25 mm/sec into molten solder of 260 ± 5°C for 10 ± 1 secs. Then the resistor is left in the room for 1 hour , and measured its resistance variance rate. Refer to JIS-C5201-1 4.18	≤± 0.5% No evidence of mechanical damage.
Vibration	The resistor shall be mounted by its terminal leads to the supporting terminals on the solid table. The entire frequency range :from 10 Hz to 55 Hz and return to 10 Hz, shall be transferred in 1 min. Amplitude : 1.5 mm This motion shall be applied for a period of 4 hours in each 3 mutually perpendicular directions (a total of 12 hr) Refer to JIS-C5201-1 4.22	≤± 0.5% No evidence of mechanical damage.

Remark

IT' S NOT UNDER CONTROL FOR PDF FILE
PLS NOTE THE VERSION STATED.

Issue Dep. **DATA Center.**

Do not copy without permission

Series No. **60**

5.3 Environmental Test

Item	Conditions	Specifications								
High Temperature Exposure	Put tested resistor in chamber under temperature $170 \pm 5^\circ\text{C}$ for 1000 hours. Then leaving the tested resistor in room temperature for 60 minutes, and measure its resistance variance rate. Refer to JIS-C5201-1 4.23.2	$\leq \pm 1.0\%$ No evidence of mechanical damage.								
Low Temperature Exposure	Put the tested resistor in chamber under temperature $-55 \pm 2^\circ\text{C}$ for 1000 hours. Then leaving the tested resistor in room temperature for 60 minutes, and measure its resistance variance rate. Refer to JIS-C5201-1 4.23.4	$\leq \pm 0.5\%$ No evidence of mechanical damage.								
Temperature cycling (Rapid Temperature Change)	Put the tested resistor in the chamber under the temperature cycling which shown in the following table shall be repeated 1000 times consecutively. Then leaving the tested resistor in the room temperature for 60 minutes, and measure its resistance variance rate. <table border="1" data-bbox="355 925 970 1061"> <thead> <tr> <th></th> <th>Testing Condition</th> </tr> </thead> <tbody> <tr> <td>Lowest Temperature</td> <td>$-55 +0/-10^\circ\text{C}$</td> </tr> <tr> <td>Highest Temperature</td> <td>$150 +10/-0^\circ\text{C}$</td> </tr> <tr> <td>Temperature-retaining time</td> <td>15 min.</td> </tr> </tbody> </table> Refer to JIS-C5201-1 4.19		Testing Condition	Lowest Temperature	$-55 +0/-10^\circ\text{C}$	Highest Temperature	$150 +10/-0^\circ\text{C}$	Temperature-retaining time	15 min.	$\leq \pm 0.5\%$ No evidence of mechanical damage.
			Testing Condition							
Lowest Temperature	$-55 +0/-10^\circ\text{C}$									
Highest Temperature	$150 +10/-0^\circ\text{C}$									
Temperature-retaining time	15 min.									
Moisture Resistance (Climatic Sequence)	Put the tested resistor in chamber and subject to 10 cycles of damp heat. Each one of which consists of the steps 1 to 7 (Figure 1). Then leaving the tested resistor in room temperature for 24 hr, and measure its resistance variance rate. Refer to MIL-STD 202 Method 106	$\leq \pm 0.5\%$ No evidence of mechanical damage.								
Moisture Life	Put the tested resistor in chamber under $85 \pm 5^\circ\text{C} / 85 \pm 5\% \text{RH}$ with 10% bias and load the rated voltage for 90 minutes on, 30 minutes off, total 1000 hours. Then leaving the tested resistor in room temperature for 60 minutes, and measure its resistance variance rate. Refer to JIS-C5201-1 4.24	$\leq \pm 0.5\%$ No evidence of mechanical damage.								
Load Life	Put the tested resistor in chamber under temperature $70 \pm 2^\circ\text{C}$ and load the rated voltage for 90 minutes on, 30 minutes off, total 1000 hours. Then leaving the tested resistor in room temperature for 60 minutes, and measure its resistance variance rate. Refer to JIS-C5201-1 4.25	$\leq \pm 1.0\%$								
		$\leq \pm 2.0\%$ (4527-3W & 4527-5W) No evidence of mechanical damage.								

Remark

IT'S NOT UNDER CONTROL FOR PDF FILE
PLS NOTE THE VERSION STATED.

Issue Dep. DATA Center.

Do not copy without permission

Series No. **60**

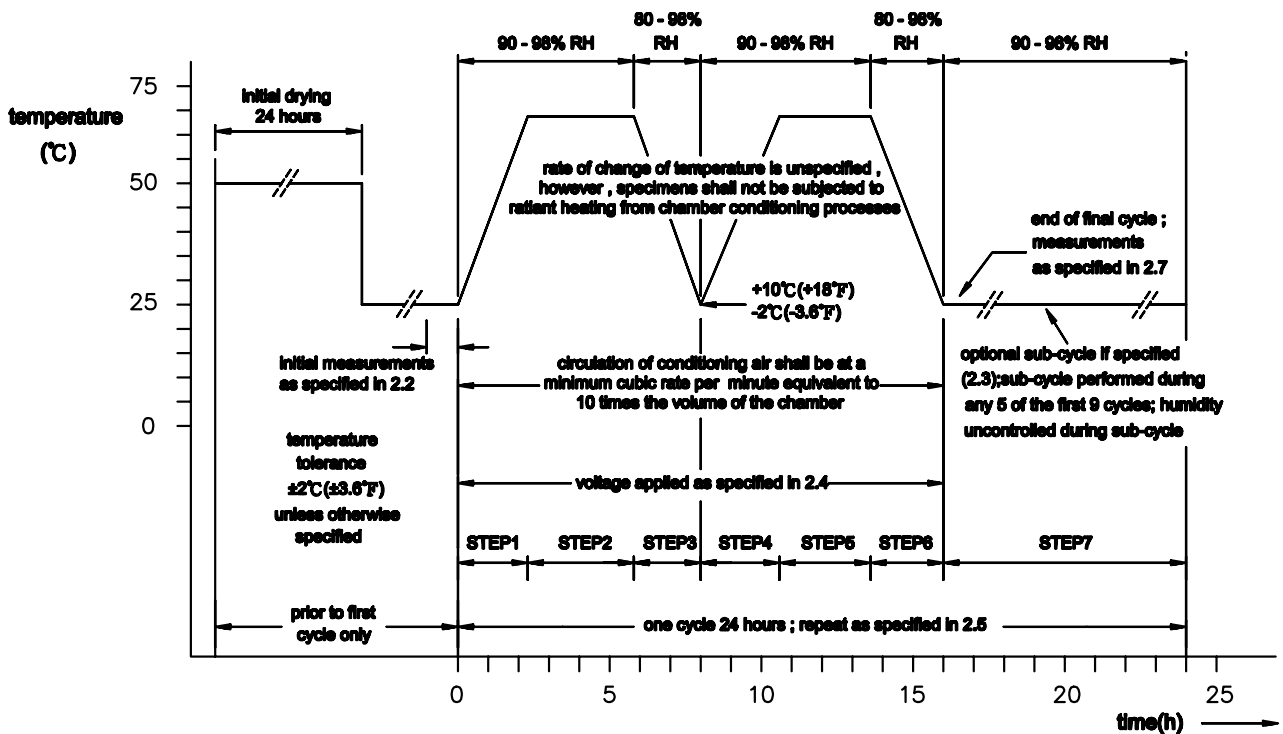

<Figure 1>

6 Recommend Soldering Method

6.1 IR Reflow Soldering Profile

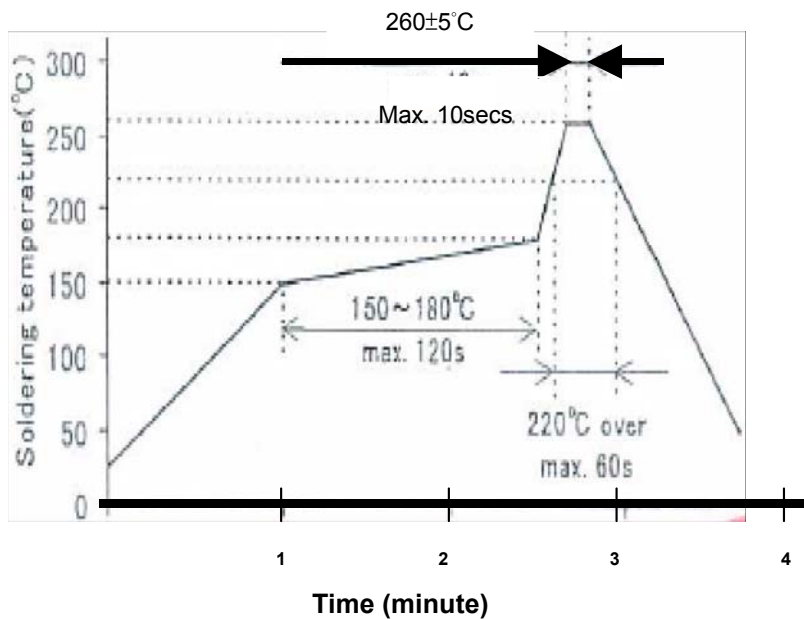

Remark

IT'S NOT UNDER CONTROL FOR PDF FILE
PLS NOTE THE VERSION STATED.

Issue Dep. DATA Center.

Do not copy without permission

Series No. **60**

6.2 Wave Soldering Profile

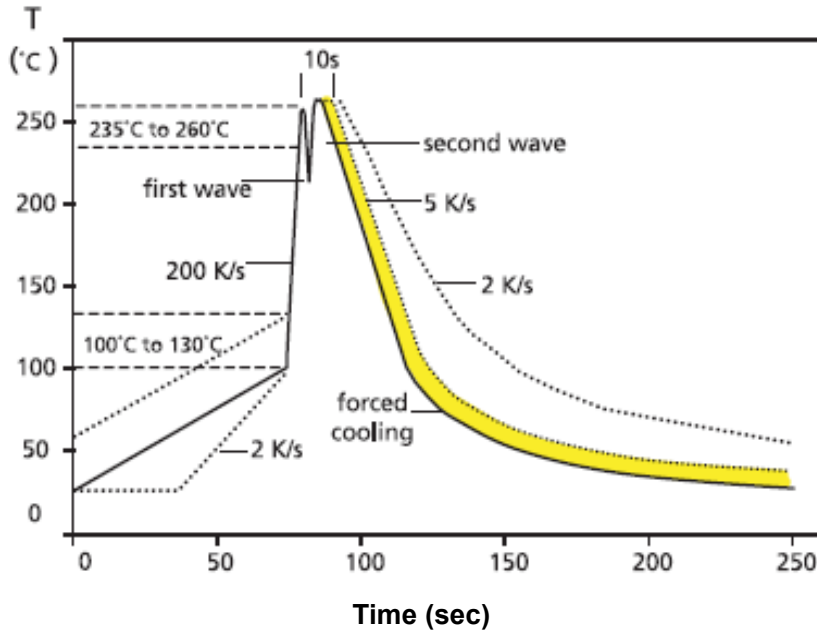

7 Recommend Land Pattern :

Unit : mm

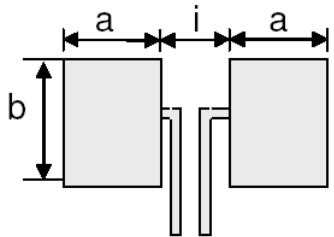

TYPE	Maximum Power Rating (Watts)	Land Pattern Dimensions			
		Resistance Range (mΩ)	a	b	i
LR1206	0.5 & 1.0	1.0~50.0	1.60	2.18	1.00
LR2010	1.0	1.0~3.0	2.89	2.92	1.22
		3.1~100.0	2.29	2.92	2.41
LR2512	1.0 & 1.5	0.5~4.0	3.05	3.68	1.27
		4.1~100.0	2.11	3.68	3.18
LR2512	2.0	0.5~4.0	3.05	3.68	1.27
		4.1~75.0	2.11	3.68	3.18
LR2512	3.0	0.50	3.05	3.68	1.27
		0.6~2.9 & 4.1~10.0	2.19	3.68	3.00
		3.0 ~ 4.0	2.79	3.68	1.80
LR2725	4.0	0.25~3.0	3.18	6.86	1.32
LR2728	3.0、3.5 & 4.0	4.0~100.0	2.75	7.82	3.51
LR4527	3.0 & 5.0	0.5~5.0	4.80	8.74	5.51
		5.1~120	3.40	8.74	8.31

Remark

IT'S NOT UNDER CONTROL FOR PDF FILE
PLS NOTE THE VERSION STATED.

Issue Dep. DATA Center.

Do not copy without permission

Series No. **60**

8 Marking (All the products marking are 4 digits)

8.1 LR1206

《EX》 Marking → R010 = 10 mΩ



8.2 LR2010

《EX》 Marking → R002 = 2 mΩ (below or equal than 3 mΩ)



《EX》 Marking → R005 = 5 mΩ (greater than 3 mΩ)



8.3 LR2512

《EX》 Marking → 0m50 = 0.5 mΩ (below than 1 mΩ)

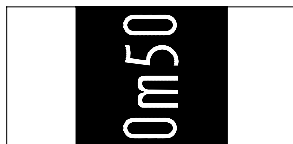

《EX》 Marking → R003 = 3 mΩ (below or equal than 4 mΩ)



《EX》 Marking → R005 = 5 mΩ (greater than 4 mΩ)



Remark

IT'S NOT UNDER CONTROL FOR PDF FILE
PLS NOTE THE VERSION STATED.

Issue Dep. DATA Center.

Do not copy without permission

Series No. **60**

《EX》 Marking → 5m25 = 5.25 mΩ (greater than 4 mΩ)

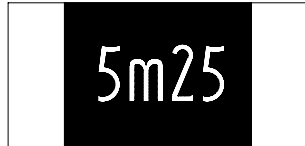

《EX》 Marking → 25m5 = 25.5 mΩ (greater than 4 mΩ)



8.4 LR2725

《EX》 Marking → 0m25 = 0.25 mΩ (for 0.25 mΩ only)

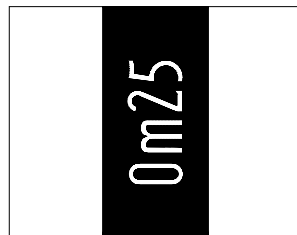

《EX》 Marking → 2m50 = 2.5 mΩ (for 2.5 mΩ only)

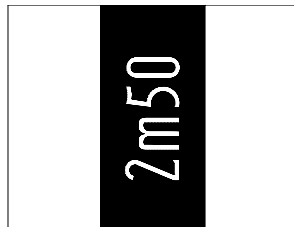

《EX》 Marking → R003 = 3 mΩ (for 1 mΩ · 2 mΩ and 3 mΩ only)

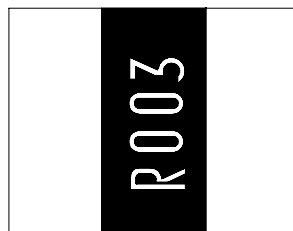

8.5 LR2728

《EX》 Marking→R005=5 mΩ

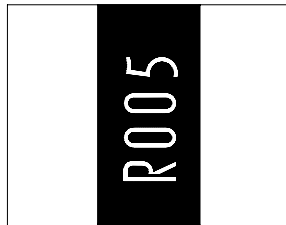

8.6 LR4527

《EX》 Marking→0m50=0.5 mΩ (for 0.50 mΩ only)

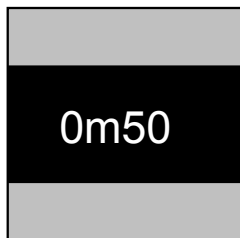

《EX》 Marking→R010=10 mΩ

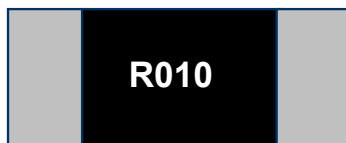

《EX》 Marking→15m5=15.5 mΩ



8.7 Marking Style

Marking Type	R	m	1	2	3	4	5	6	7	8	9	0
LR1206												
LR2010	R	m	1	2	3	4	5	6	7	8	9	0
LR2512												
LR2725												
LR2728												
LR4527												

Remark

IT'S NOT UNDER CONTROL FOR PDF FILE
PLS NOTE THE VERSION STATED.

Issue Dep. DATA Center.

Do not copy without permission

Series No. **60**

9 Taping Specifications

9.1 Tape Dimension:

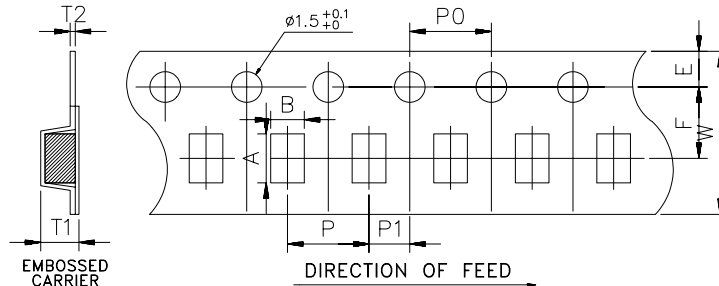

unit : mm

DIM TYPE	A	B	W	E	F	T1	T2	P	P0	10x P0	P1
LR1206	3.48± 0.10	1.83± 0.10	8.0± 0.15	1.75± 0.10	3.5± 0.10	0.90± 0.10	0.20± 0.05	4.0± 0.10	4.0± 0.10	40.0± 0.20	2.0± 0.10
LR2010	5.45± 0.10	2.90± 0.10	12.0± 0.15	1.75± 0.10	5.5± 0.10	1.10± 0.10	0.23± 0.05	4.0± 0.10	4.0± 0.10	40.0± 0.20	2.0± 0.10
LR2512	6.74± 0.10	3.90± 0.10	12.0± 0.15	1.75± 0.10	5.5± 0.10	1.08± 0.10	0.24± 0.05	8.0± 0.10	4.0± 0.10	40.0± 0.20	2.0± 0.10
LR2725	7.15± 0.10	6.75± 0.10	12.0± 0.15	1.75± 0.10	5.5± 0.10	1.70± 0.10	0.25± 0.05	8.0± 0.10	4.0± 0.10	40.0± 0.20	2.0± 0.10
LR2728	7.15± 0.10	7.70± 0.10	12.0± 0.15	1.75± 0.10	5.5± 0.10	1.20± 0.10	0.25± 0.05	12.0± 0.10	4.0± 0.10	40.0± 0.20	2.0± 0.10
LR4527	11.80± 0.10	7.20± 0.10	24.0± 0.15	1.75± 0.10	11.5± 0.10	1.70± 0.10	0.30± 0.10	12.0± 0.10	4.0± 0.10	40.0± 0.20	2.0± 0.10

9.2 Packaging Quantity:

Type	Tape Width	Packaging Quantity (pcs/reel)		
		Emboss Plastic Type		
		4 mm Pitch	8 mm Pitch	12 mm Pitch
LR1206	8 mm	4000 pcs		
LR2010	12 mm	2000 pcs		
LR2512	12 mm		2000 pcs	
LR2725	12 mm		1000 pcs	
LR2728	12 mm			1000 pcs
LR4527	24 mm			500 pcs

9.3 Reel Dimensions:

Unit : mm

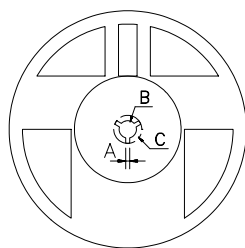

Reel Type/ Tape	W	M	A	B	C	D
7" reel for 8 mm tape	12.0 ± 0.5	178 ± 1.0	2.0 ± 0.5	13.2 ± 0.5	17.7 ± 0.5	60.0 ± 0.5
7" reel for 12 mm tape	16.2 ± 0.5		2.5 ± 0.5	13.5 ± 0.5		60.0 ± 0.5
7" reel for 24 mm tape	24.4 +2/-0		2.0 ± 0.5	13.2 ± 0.5		60.0 ± 0.5

10 Attachments

10.1 Document Revise Record

(QA-QR-027)

Remark	IT' S NOT UNDER CONTROL FOR PDF FILE PLS NOTE THE VERSION STATED.	Issue Dep. DATA Center.
	Do not copy without permission	Series No. 60