



SAMXON SUPERCAP

ELECTRIC DOUBLE LAYER CAPACITORS

2016



QC 080000



ISO 9001 ISO 14001



ACCREDITED

目录

Contents

P.2	===== =====	超级电容器 Electric Double Layer Capacitors (EDLC)
P.3	===== =====	使用指南 Application Guidelines
P.14	===== =====	产品一览表 Series Table
P.15	===== =====	产品编码 Part Number System
P.16	===== =====	DRC 系列 Series
P.18	===== =====	DCC 系列 Series
P.20	===== =====	DRE 系列 Series
P.24	===== =====	DRL 系列 Series
P.28	===== =====	DDL 系列 Series



EDLC超级电容器

Electric Double Layer Capacitors

特性与优势 Features and Benefits

- 提供不同应用设计产品
- 提供各类单体尺寸以满足不同客户空间需求
- 可按要求设定容量、内阻及温度特性
- 提供各类电压系列产品
- 完整的系统解决方案

- Application specific designs
- Customized form factors to meet most mechanical requirements
- Tailored capacitance, ESR and temperature capability
- Series configurations for higher voltages
- Complete system solutions

应用类型 Application Types

- 脉冲电源
- 桥接或辅助电源
- 主电源
- 存储器后备电源

- Pulse power
- Bridge or hold-up power
- Main power
- Memory backup

应用领域 Application Segments

- 工业 Industrial
- 消费 Consumer
- 医疗 Medical
- 汽车 Automotive
- 军事 Military

使用指南 Application Guidelines

此档将提供电容器 (EDLC) 基本应用开发指南。若在开发使用过程中遇到问题且在此文件中找不到相关解决方案，请直接与我们联系。

This document provides basic guidelines for application development using capacitors, also known as EDLC. If questions arise during your development process and are not answered in the document, please contact us directly.

寿命 Life Time

EDLC具有二次电池更长久的寿命，但是其寿命也不是无限长的。EDLC基本的寿命终止失效模式为等效串联电阻 (ESR) 升高和/或容量的降低。实际的寿命终止标准取决于应用要求。长期置于高温下，高电压和超电流将会导致ESR升高和容量降低。这些参数的降低将可延长超级电容器的寿命。一般来说，圆筒型EDLC具有与电解电容器相类似的构造，有电解液、铝壳和胶粒。多年使用后，EDLC内电解液也会干涸，如同电解电容器一样，导致ESR升高，寿命终止。

EDLC has a longer life time than secondary batteries, but their life time is not infinite. The basic end-of-life failure mode for an EDLC is an increase in equivalent series resistance (ESR) and/or a decrease in capacitance. The actual end-of-life criteria are dependent on the application requirements. Prolonged exposure to elevated temperatures, high applied voltage and excessive current will lead to increased ESR and decreased capacitance. Reducing these parameters will lengthen the life time of a supercapacitor. In general, cylindrical EDLC have a similar construction to electrolytic capacitors, they have a liquid electrolyte inside an aluminum can sealed with a rubber bung. Over many years, the EDLC will dry out, similar to an electrolytic capacitor, causing an increase in ESR and eventually end-of-life.

电压 Voltage

EDLC是有额定的推荐工作或使用电压的。电压值是基于其在最高额定温度下最长寿命来设定的。如果使用电压超出了推荐电压，其结果将会导致寿命缩短。如果电压持续过高，EDLC内将会产生气体，导致漏液或防爆阀破裂。但EDLC是可以承受短期过电压的。

EDLC are rated with a nominal recommended working or applied voltage. The values provided are set for long life at their maximum rated temperature. If the applied voltage exceeds the recommended voltage, the life time will be reduced. If the applied voltage is excessive for a prolonged time period, gas generation will occur inside the EDLC and may result in leakage or rupture of the safety vent. However, short-term over voltage can usually be tolerated by the EDLC.

使用指南 Application Guidelines

极性 Polarity

EDLC的电极设计具有相对称的特性，即两极有相似的成分。在EDLC初次组装时，任一电极都可定为正极或负极。但EDLC在100%质量测试时第一次充电，其电极将会形成极性化。每一EDLC都有负极框或符号来标识极性。尽管其可以降低到零电压，其电极还是会保留非常少的电荷。虽然之前充电的EDLC会放电至-2.5V且在容量或ESR方面至极低，但还是不应进行反极使用。

EDLC are designed with symmetrical electrodes, meaning they are similar in composition. When an EDLC is first assembled, either electrode can be designated positive or negative. Once the EDLC is charged for the first time during the 100% QA testing operation, the electrodes become polarized. Every EDLC has a negative stripe or sign denoting polarity. Although they can be shorted to zero volts, the electrodes maintain a very small amount of charge. Reversing polarity is not recommended, however previously charged EDLC have been discharged to -2.5V with no measurable difference in capacitance or ESR.

注：在一方向上保留的电荷越久，EDLC就变得越极性化。如果在一方向上长期充电后再进行反向充电，EDLC的寿命将会大大地缩短。

Note: The longer they are held charged in one direction, the more polarized they become. If reversely charged after prolonged charging in one direction, the life of the EDLC may be shortened.

环境温度 Ambient Temperature

DRE系列电容的标准温度范围为-25°C~+70°C，DRL系列电容的标准温度范围为-40°C~+60°C。温度及电压会对EDLC寿命有影响。一般来说，环境温度每提升10°C，EDLC寿命就会缩短一半。因此，建议尽可能在最低温度下使用EDLC以降低内部劣化与ESR升高。在低于正常室温环境下，可使用稍高于额定工作电压而不造成内部劣化和寿命缩短。在低温下提升使用电压将可抵消ESR的升高。高温下ESR的升高会导致EDLC永久性劣化/电解液分解。在低温下，因电解液粘性的提升及离子的缓性移动缘故，ESR升高只是一种短暂现象。

The standard temperature range is -25°C to +70°C for DRE series or -40°C to +60°C for DRL series. Temperature in combination with voltage can affect the life time of an EDLC. In general, raising the ambient temperature by 10°C will decrease the life time of an EDLC by a factor of two. As a result, it is recommended to use the EDLC at the lowest temperature possible to decrease internal degradation and ESR increase. At temperature lower than normal room temperature, it is possible to apply voltages slightly higher than the recommended working voltage without significant increase in degradation and reduction in life time. Raising the applied voltage at low temperatures can be useful to offset the increased ESR. Increased ESR at higher temperatures will result in permanent degradation/electrolyte decomposition inside the EDLC. At low temperatures, however, increased ESR is only a temporary phenomenon due to the increased viscosity of the electrolyte and slower movement of the ions.

使用指南 Application Guidelines

放电特性 Discharge Characteristics

EDLC放电时电压是呈斜线的。在确定应用时的容量与ESR要求时，考虑耐压放电和电容性放电成分是很重要的。在高脉冲电流应用时，内阻值是最为关键的。在低电流长时间应用时，电容放电特性是最为关键的。

EDLC discharges with a sloping voltage curve. When determining the capacitance and ESR requirements for an application, it is important to consider both the resistive and capacitive discharge components. In high current pulse applications, the resistive component is the most critical. In low current and long duration applications, the capacitive discharge component is the most critical.

在I电流下放电t (秒) 时电压降低Vdrop公式为：

$$V_{\text{drop}} = I (R+t/C)$$

在脉冲电池应用时，须使用低ESR (R值) EDLC以减低电压降幅。

在低电流应用时，应使用高容量 (C值) EDLC。

The formula for the voltage drop, V_{drop} , during a discharge at I current for t seconds is:

$$V_{\text{drop}} = I (R+t/C)$$

To minimize voltage drop in a pulse application, use an EDLC with low ESR (R value).

To minimize voltage drop in a low current application, use an EDLC with large capacitance (C value).

充电方法 Charge Methods

EDLC可用各种方法进行充电，包括恒定电流、恒定功率、恒定电压或与能量储存器，如电池、燃料电池、直流转换器等进行并联。如果EDLC与电池并联，加一个低阻值串联电阻将会提升电池的寿命。如果使用串联电阻，须确保EDLC电压输出端是直接与应用器连接而不是通过电阻与应用器连接，否则EDLC的低ESR将无效。在高脉冲电流放电时，许多电池系统寿命均会缩短。

EDLC can be charged using various methods including constant current, constant power, constant voltage or by paralleling to an energy source, i.e. battery, fuel cell, DC converter, etc. If an EDLC is configured in parallel with a battery, adding a low value resistor in series will increase the life of the battery. If a series resistor is used, ensure that the voltage outputs of the EDLC are connected directly to the application and not through the resistor; otherwise the low ESR of the EDLC will be nullified. Many battery systems exhibit decreased life time when exposed to high current discharge pulses.

使用指南 Application Guidelines

EDLC建议最大充电电流I应按以下方式计算，Vw为充电电压，R为EDLC ESR：

$$I = Vw/5R$$

持续大电流或高电压充电，EDLC将会过度发热。过度发热将会导致ESR提升，气体产生，寿命缩短，漏液，防爆阀破裂。如果要使用高于额定值的电流或电压充电请与生产厂商联系。

The maximum recommended charge current I, for an EDLC where Vw is the charge voltage and R is the EDLC ESR is calculated as below:

$$I = Vw/5R$$

Overheating of the EDLC can occur from continuous overcurrent or overvoltage charging. Overheating can lead to increased ESR, gas generation, decreased life time, leakage, venting or rupture. Contact the factory if you plan to use a charge current or voltage higher than specified.

自放电与漏电流 Self Discharge and Leakage Current

以不同方法进行测量时自放电和漏电流在本质上是相同的，因为EDLC在构造上，从正极到负极具备高的耐电流特性。也即是说为保留电容电荷，需要少量的额外电流，此称为漏电流。当充电电压移除，电容不在负荷时，额外的电流会促使EDLC放电，此称为自放电电流。

Self discharge and leakage current are essentially the same thing measured in different ways. Due to the EDLC construction, there is a high-resistance internal current path from the anode to the cathode. This means that in order to maintain the charge on the capacitor a small amount of additional current is required. During charging this is referred to as leakage current. When the charging voltage is removed, and the capacitor is not loaded, this additional current will urge the EDLC to discharge and is referred to as the self discharge current.

为测量实际的漏电流或自放电数值，因构造原因，EDLC须充电100小时以上。EDLC可模拟为几个并联的电容器，每一个都有不同的串联电阻值。低串联电阻值的电容器能迅速充电从而提升终端电压达到充电电压值的同一水平。但在充电电压移除时，如果这些并联的电容器之中有未完全充电的话，电容器将会放电到具有较高串联电阻的并联电容器中。结果就是终端电压将会降低，形成高自放电电流。须注意容量越高，完全充电时间就越久。

In order to get a realistic measurement of leakage or self discharge current the EDLC must be charged for an excess of 100 hours. This is also due to the capacitor construction. The EDLC can be modeled as several capacitors connected in parallel, each with an increasing value of series resistance. The capacitors with low values of series resistance are charged quickly thus increasing the terminal voltage to the same level as the charge voltage. However, if the charge voltage is removed these capacitors will discharge into the parallel capacitors with higher series resistance if they are not fully charged. The result of this is that the terminal voltage will fall, giving the impression of high self discharge current. It should be noted that the higher the capacitance value is, the longer it will take for the device to be fully charged.

EDLC系列设置 Series Configurations of EDLC

单个DRE系列EDLC电压限制为2.5V，DRL系列EDLC电压限制为2.7V。因许多应用领域要求高电压，EDLC可以设置为串联以提升工作电压。确保单一的EDLC电压不超过其最大的额定工作电压是很重要的，否则会导致电解液分解，气体产生，ESR升高，寿命缩短。

Individual EDLC are limited to 2.5V for DRE series or 2.7V for DRL series. As many applications require higher voltages, EDLC can be configured in series to increase the working voltage. It is important to ensure that the individual voltage of any single EDLC does not exceed its maximum recommended working voltage as this will result in electrolyte decomposition, gas generation, increased ESR and reduced life time.

充电和放电时，在稳态下因容量和漏电流差异，将会产生电容器电压不平衡现象。在充电时，串联电容器将起到电压分配作用，因此低容值单体将会承受更大的电压。例如：2个1F电容器进行串联，一个电容器容量为+20%，另一个容量为-20%，电压通过电容器的最差情况为：

$$V_{cap2} = V_{supply} \times (C_{cap1} / (C_{cap1} + C_{cap2}))$$

其中Ccap1具备+20%容量。

则Vsupply = 5V，

$$V_{cap2} = 5V \times (1.2 / (1.2 + 0.8)) = 3V$$

Capacitor voltage imbalance is caused, during charge and discharge, by differences in capacitance value and, in steady state, by differences in capacitor leakage current. During charging, series connected capacitors will act as a voltage divider so higher capacitance devices will receive greater voltage stress. For example, if two 1F capacitors are connected in series, one at +20% of nominal capacitance, the other at -20%, the worst-case voltage across the capacitors is given by:

$$V_{cap2} = V_{supply} \times (C_{cap1} / (C_{cap1} + C_{cap2}))$$

where Ccap1 has the +20% capacitance.

So for a Vsupply = 5V,

$$V_{cap2} = 5V \times (1.2 / (1.2 + 0.8)) = 3V$$

从上可以看出，为避免超出3V的EDLC浪涌电压范围，串联电容器的容量值应在±20%的公差范围内。在选择上，一个合适的主动电压平衡电路可用来降低因容值不平衡而产生的电压不平衡。须注意到大多数的电压平衡方法都是取决于具体的应用。

From above, it can be seen that in order to avoid exceeding the EDLC surge voltage rating of 3V, the capacitance values of series connected parts must fall in a ±20% tolerance range. Alternatively a suitable active voltage balancing circuit can be employed to reduce voltage imbalance due to capacitance mismatch. It should be noted that the most appropriate method of voltage balancing depends on the specific application.

使用指南 Application Guidelines

被动电压平衡 Passive Voltage Balancing

被动电压平衡可用电压分配电阻与每一EDLC并联来实现。这可让电流从高电压的EDLC上流至低电压的EDLC上从而实现电压的平衡。最重要是选择平衡电阻值以提供EDLC更高电流的流动而不增加EDLC的漏电流。须记住在高温下漏电流是会上升的。

Passive voltage balancing uses voltage-dividing resistors in parallel with each EDLC. This allows current to flow from the EDLC at a higher voltage level into the EDLC at a lower voltage level, thus balancing the voltage. It is important to choose balancing resistors values that provide for higher current flow than the anticipated leakage current of the EDLC, bearing in mind that the leakage current will increase at higher temperatures.

被动电压平衡只在不经常进行EDLC充放电使用和使用能承受平衡电阻的额外电流负载时推荐使用。建议所选择的平衡电阻应能提供最差EDLC漏电流50倍以上的额外电流 (根据最高使用温度选择 $3.3\text{k}\Omega$ ~ $22\text{k}\Omega$ 的电阻)。尽管更大阻值的平衡电阻在大多数情况下也能工作，但其不可能在不匹配的电容器串联时起到保护作用。

Passive voltage balancing is only recommended for applications that don't regularly charge and discharge the EDLC and that can tolerate the additional load current of the balancing resistors. It is suggested that the balancing resistors be selected to give additional current flow of at least 50 times the worst-case EDLC leakage current ($3.3\text{k}\Omega$ to $22\text{k}\Omega$ depending on maximum operating temperature). Although higher values of balancing resistors will work in most cases they are unlikely to provide adequate protection when significantly mismatched parts are connected in series.

主动电压平衡 Active Voltage Balancing

主动电压平衡电路能使串联的EDLC上的电压与特定参数电压相同，而不管有多少电压不平衡产生。同时确保在稳态情况下准确的电压平衡电路能有效地降低电流，而且只在电容电压发生不平衡时才要求更大的电流。这些特性使得主动电压平衡电路是EDLC频繁充放电及如电池等能量组件使用的最理想电路。

Active voltage balancing circuits force the voltage at the nodes of series connected EDLC to be the same as a fixed reference voltage, regardless of how many voltage imbalances occur. To ensure accurate voltage balancing, active circuits typically draw much lower levels of current in steady state and only require larger currents when the capacitor voltage goes out of balance. These characteristics make active voltage balancing circuits ideal for applications that charge and discharge the EDLC frequently as well as those with a finite energy source such as a battery.

使用指南 Application Guidelines

逆向电压防护 Reverse Voltage Protection

当串联EDLC迅速放电，容量值低的电容器之上的电压将潜在地变为负电压。如之前的解释，此是不希望出现的且会缩短EDLC的工作寿命。一种简单的防护逆向电压的方法是在电容器上增加一个二极管。使用适当的额定的限流二极管替代标准的二极管，还可以保护EDLC出现过电压现象。须谨慎的是确保二极管能承受电源的峰值电流。

When series connected EDLC are rapidly discharged, the voltage on low capacitance value parts can potentially become negative. As explained previously, this is not desirable and can reduce the operating life of the EDLC. One simple way of protecting reverse voltage is to add a diode across the capacitor, configured so that it is normally reverse bias. By using a suitably rated zener diode in place of a standard diode the EDLC can also be protected against overvoltage events. Care must be taken to ensure that the diode can withstand the available peak current from the power source.

焊接信息 Soldering Information

过热会导致EDLC电性能的退化，漏液或内压升高。焊接应遵循以下具体指示：

- 不要把EDLC浸入已熔解的焊锡中。
- 只在EDLC导针上粘上焊剂。
- 确保EDLC套管不直接与PCB或其它组件接触，过高的焊锡温度会导致套管收缩或破裂。
- 避免EDLC在裸露的电路板之下工作以防止短路发生。

Excessive heat may cause deterioration of the electrical characteristics of the EDLC, electrolyte leakage or an increase in internal pressure. Follow the specific instructions listed as below:

- Do not dip EDLC body into melted solder.
- Only flux the leads of the EDLC.
- Ensure that there is no direct contact between the sleeve of the EDLC and the PC board or any other component. Excessive solder temperature may cause sleeve to shrink or crack.
- Avoid exposed circuit board runs under the EDLC to prevent electrical shorts.

手工焊接 Manual Soldering

不可让EDLC外部套管与焊棒接触，否则套管会熔化或破裂。焊嘴温度建议低于350°C，焊接持续时间少于4秒钟。应使烙铁与EDLC导针直接接触时间最小化，因为导针的过热会提高等效串联电阻值(ESR)。

Do not touch the EDLC's external sleeve with the soldering rod, or the sleeve will melt or crack. The recommended temperature of the soldering rod tip is less than 350°C and the soldering duration should be less than 4 seconds. Minimize the time that the soldering iron is in direct contact with the terminals of the EDLC, as excessive heating of the leads may lead to higher equivalent series resistance (ESR).

使用指南 Application Guidelines

波峰焊 Wave Soldering

最多给PCB预热60秒钟，浸锡达0.8mm或更厚。预热温度极限应低于100°C。

Use a maximum preheating time of 60 seconds for PC boards 0.8mm or thicker. Preheating temperature should be limited to less than 100°C.

以下表格信息只用于导针的波峰焊接：

Use the following table for wave soldering on leads only:

焊锡温度 (°C) Solder Bath Temperature (°C)	建议焊锡时间 (秒) Recommended Solder Exposure (seconds)	最大焊接时间 (秒) Maximum Solder Exposure (seconds)
220	7	9
240	7	9
250	5	7
260	3	5

回流焊接 Reflow Soldering

除非EDLC有明确的额定耐回流焊接温度，否则不应EDLC使用回流焊接而应使用红外线或传送烤炉加热方法进行焊接。

Unless the EDLC is specifically rated to withstand reflow soldering temperature, do not use reflow soldering, infrared or convection heating methods on the EDLC.

纹波电流 Ripple Current

EDLC相对于其它超级电容来说有很低的电阻，相比铝电解电容器有更高的电阻且在纹波电流之中容易受内部热量的影响而使ESR升高，寿命缩短。为确保长久的寿命，建议最大纹波电流不应使EDLC表面温度提升高于3°C。

EDLC have a very low resistance compared to other supercapacitors but have a higher resistance than aluminum electrolytic capacitors. EDLC are more susceptible to internal heat generation when exposed to ripple current. In order to ensure long life time, the maximum ripple current recommended should not increase the surface temperature of the EDLC by more than 3°C, as heat generation leads to electrolyte decomposition, gas generation, increased ESR and reduced life time.

使用指南 Application Guidelines

电路板设计 Circuit Board Design

尽量避免清洁电路板，如果要进行电路板清洁，应使用标准电路板清洁液通过无静电或超音波浸渍方法进行清洁，时间不超过5分钟，最高温度不高于+60°C。之后要彻底冲洗和风干。一般来说，应将EDLC如同铝电解电容器一样对待。

Cleaning of the circuit board should be avoided. If the circuit board must be cleaned use static or ultrasonic immersion in a standard circuit board cleaning fluid for no more than 5 minutes and a maximum temperature of +60°C. Afterwards thoroughly rinse and dry the circuit boards. In general, treat EDLC in the same manner you would an aluminum electrolytic capacitor.

长期贮存 Long Term Storage

不要在以下环境中贮存EDLC：

- 高温/高湿度下贮存
- 直接与水，盐水，油或其它化学品接触
- 直接与腐蚀性材料，酸，碱金属或有毒气体接触
- 阳光直射
- 粉尘环境
- 冲击和/或振动环境

Do not store EDLC in any of the following environments:

- High temperature and/or high humidity
- Direct contact with water, salt water, oil or other chemicals
- Direct contact with corrosive materials, acids, alkalis or toxic gases
- Direct exposure to sunlight
- Dusty environment
- Environment subject to excessive shock and/or vibration

运输信息 Transportation Information

EDLC的国际运输受到US DOT (运输部)/IATA规定，正确的国际运输产品编码 UN3499 CAPACITOR, electric double layer. 详情可参照以下国际运输规定：

EDLC are regulated by the US DOT/IATA transportation regulations. Proper shipping name for EDLCs is UN3499 CAPACITOR, electric double layer. These transportation regulations, include:

- the 2013 – 2014 ICAO Technical Instructions on the Safe Transport of Dangerous Goods by Air (54th edition of the International Air Transport Association Dangerous Goods Regulations);
- the International Maritime Dangerous Goods Code incorporating amendment 36-12;
- the European road and rail regulations (the ADR and RID); and
- the US Hazardous Materials Regulations in Title 49 of the Code of Federal Regulations (Parts 171 to 180).

使用指南 Application Guidelines

紧急事故应急程序 Emergency Procedures

如果发现EDLC过热或是闻到气味，应立即断开与EDLC连接的电源或负载。让EDLC降温，然后进行正确处理。不可让脸或手接触过热的EDLC。如果EDLC发生漏液或防爆阀破裂请与生产厂商联系索取材料安全资料表。

If an EDLC is found to be overheating or if you smell a sweet odor, immediately disconnect any power or load to the EDLC. Allow the EDLC to cool down, then dispose it properly. Do not expose your face or hands to an overheating EDLC. Contact the factory for a Material Safety Data Sheet if an EDLC leaks or vents.

如果有漏液情况：

皮肤接触：用肥皂和水冲洗皮肤。

眼睛接触：用水清洗眼睛15分钟，看医生。

吸取：喝牛奶/水并吐出，看医生。

If exposed to electrolyte:

Skin Contact: Wash exposed area thoroughly with soap and water.

Eye Contact: Rinse eyes with water for 15 minutes and seek medical attention.

Ingestion: Drink milk/water and induce vomiting; seek medical attention.

一般性安全考虑 General Safety Considerations

如果过度充电，反向充电，焚烧或高于150°C加热，EDLC有可能发生防爆阀爆裂。不要压挤，损伤，压钉或拆解EDLC。滥用EDLC可能导致铝壳升上高温（烧伤）。

EDLC may vent or rupture if overcharged, reverse charged, incinerated or heated above 150°C. Do not crush, mutilate, nail penetrate or disassemble. High case temperature (burn hazard) may result from abuse of EDLC.

废弃处理程序：

不要随便丢弃，应根据当地法律法规进行处理。

Disposal Procedures:

Do not dispose of unit in trash. Dispose of according to local regulations.

温度表现 Thermal Performance

使用时能量贮存单位上低内阻会使得低热量产生。电子产品使用温度越低，其工作时间越久。大多数使用领域自然空气对流都能提供足够的冷却环境。在恶劣环境中使用，还要求有最长的使用寿命则需要添加一些空气对流设备。

Low internal resistance of the energy storage units enables low heat generation within the units during use. As with any electronic components, the cooler the operating environment the longer the service life. In most applications, natural air convection should provide adequate cooling. In severe application requiring maximum service life some forced airflow may be required.

针对耐热来说，测量产品的Rth需在环境温度（-25°C）下进行并允许自然对流。数据表上的Rth值对确定产品工作极限值是有用的。利用Rth值，可计算出任何电流和工作循环下的温升。

The thermal resistance, Rth of the units have been experimentally determined assuming free convection at ambient temperature (-25°C). The Rth value provided on the data sheet is useful for determining the operating limits for the units. Using the Rth value, a module temperature rise can be determined based upon any current and duty cycle.

温升可用以下公式计算：

$$\Delta T = Dc \cdot Rth \cdot I^2 \cdot Resr$$

其中 Dc = 工作循环

Rth = 热阻值 (°C/W)

I = AC或DC电流 (A)

Resr = 等效串联电阻，(Ohms) (使用直流电)

The temperature rise can be expressed by the following equation:

$$\Delta T = Dc \cdot Rth \cdot I^2 \cdot Resr$$

where Dc = Duty Cycle

Rth = Thermal Resistance (°C/W)

I = Current AC or DC (A)

Resr = Equivalent Series Resistance, (Ohms) (dc value used)

环境温度加上温升， ΔT ，应控制在最高工作温度之下。如果使用冷却方法，则产品可容许大电流工作及增加循环寿命。

This temperature rise, ΔT , plus ambient temperature should remain below the specified maximum operating temperature for the EDLC. If forced cooling methods are employed, it is possible to operate the units at higher currents or duty cycles.





使用指南 Application Guidelines

特性 Features

- 可用作充电电池及后备电源。
 - 具备数十万次充电/放电循环次数，免却废物处理。
 - 不含有毒材料，如镍及镉。
- Can be used as a rechargeable battery and ideal for back up purposes.
 - Capable of several hundreds of thousands of charge/discharge cycles; free from throwaway disposal.
 - Does not contain toxic materials such as nickel and cadmium.

超级电容器 Electric Double Layer Capacitors

产品一览表 Series Table

系列 Series	特性 Features	温度范围 Temp. Range		容量 Capacitance	最大工作电压 Max. Operating Voltage	套管颜色 Sleeve Color	印字颜色 Letter Color	产品图片 Product Photo	页面 Page
		Min.	Max.						
DRC	高能量密度 Higher Energy Density	-25°C	+70°C	10~800F	2.3 V.DC	绿色 Green	白色 White		P.16
DCC	高能量密度 Higher Energy Density 低漏电 Lower Leakage Current	-25°C	+70°C	10~220F	2.3 V.DC	绿色 Green	白色 White		P.18
DRE	高能量 High Energy 高温 High Temperature	-25°C	+70°C	0.3~3800F	2.5 V.DC	绿色 Green	白色 White		P.20
DRL	高能量 High Energy 大功率型 High Power Type 低阻抗 Low ESR	-40°C	+60°C	0.3~3800F	2.7 V.DC	绿色 Green	白色 White		P.24
DDL	更高电压 Higher Voltage	-40°C	+60°C	0.22~11F	5 V.DC	绿色 Green	白色 White		P.28

产品编码 Part Number System

• 第一部分 Part 1

1 2 3 D R E	4 5 6 1 0 5	7 M	8 9 0 E	10 F	11 12 1 2	13 14 R R						
系列 Series	容量 Capacitance	公差 Tolerance	电压 Voltage	铝壳直径 Case Dia.	铝壳长度 Case Len.	成型类型 Type						
系列 Series	容量 Cap. (F)	代码 Code	公差 Tol. (%)	代码 Code	电压 Vol. (V)	代码 Code	直径 Dia. (mm)	代码 Code	长度 Len. (mm)	代码 Code	特征 Feature	代码 Code
DRC	0.3	304	±20	M	2.3	03	4	C	11	11	导针型散装 Radial bulk	RR
DCC	1.0	105	-20~+50	S	2.5	0E	8	F	12	12	自立型 Snap-in	SC
DRE	3.0	305	-10~+20	V	2.7	0T	10	G	20	20	自立型 Snap-in	SZ
DRL	4.7	475					12.5	I	25	25	螺钉型 Screw	AD
	10	106					16	K	30	30	螺钉型 Screw	A3
	22	226					18	L	40	40	螺钉型 Screw	A4
	33	336					22	N	45	45		
	50	506					25	O	50	50		
	90	906					30	P	55	55		
	100	107					35	Q	60	60		
	120	127					60	6	80	80		
	150	157							95	95		
	200	207							100	1L		
	220	227							105	1K		
	250	257							120	1N		
	350	357							130	1P		
	1200	128							150	1R		
	2500	258										
3000	308											
3800	388											

• 第二部分 Part 2

1 2 3 D D L	4 5 6 4 7 4	7 M	8 9 0 H	10 F	11 12 1 E	13 14 R R						
系列 Series	容量 Capacitance	公差 Tolerance	电压 Voltage	铝壳尺寸 Case Dim.	铝壳高度 Case Ht.	成型类型 Type						
系列 Series	容量 Cap. (F)	代码 Code	公差 Tol. (%)	代码 Code	电压 Vol. (V)	代码 Code	宽度 x 长度 Width x Length (mm)	代码 Code	高度 Height (mm)	代码 Code	特征 Feature	代码 Code
DDL	0.22	224	±20	M	5.0	0H	9 x 17.5	F	15.5	1E	导针型散装 Radial bulk	RR
	0.47	474	-20~+50	S	5.5	05	11 x 21.5	G	19.5	1J		
	1.0	105					13.5 x 26.5	H	23.5	2C		
	1.5	155					13.5 x 30	I	29	29		
	2.5	255					20 x 40	K				
	4.0	405										
	8.0	805										
	12	126										

特性 Features

- | | |
|---------------------------------|--|
| • 高能量密度
(2倍于2.5V/2.7V 超级电容器) | Higher energy density
(2 times of 2.5V/2.7V EDLC) |
| • 快速充电/放电 | Quick charge & discharge |
| • 符合RoHS无铅要求 | RoHS directive compliant |



推荐应用领域 Recommended Applications

- | | |
|------------|----------------------------------|
| • 太阳能地砖灯 | Solar Brick Light |
| • 再生能源储能系统 | Renewable Energy Storage Systems |

规格 Specifications

项目 Item	性能 Performance Characteristics	
温度 Temperature		
工作温度范围 Operating Temperature Range	-25°C to +70°C	
容量 Capacitance		
容量范围 Nominal Capacitance Range	10F to 800F	
容量公差 Capacitance Tolerance	±20% or -20%~+50%	
电压 Voltage		
额定电压 Rated Voltage	2.3 V.DC	
浪涌电压 Surge Voltage	2.5 V.DC	
最大工作电压 Maximum Operating Voltage	2.3 V.DC	
阻抗 Resistance		
直流等值阻抗 ESR, DC	详见附件电性能列表 Please see the attached characteristics list	
交流等值阻抗 ESR, AC	详见附件电性能列表 (1kHz/20°C) Please see the attached characteristics list (1kHz/20°C)	
寿命 Lifespan		
贮存寿命 Shelf Life	+70°C下无负荷贮存1,000小时后电容器符合规定的限值 After 1,000 hours storage at +70°C without load, the capacitor shall meet the specified limits for endurance.	
耐用性 Endurance	+70°C下采用额定电压1,000小时后电容器符合以下限定值 After 1,000 hours application of rated voltage at +70°C, the capacitor shall meet the following limits.	
	容量变化 Capacitance Change	初始测试值的±30% ±30% of initial measured value
	内阻 Internal Resistance	≤初始值的2倍 ≤2 times of initial specified value
循环次数 Cycles		
循环次数 Cycles	在+25°C下, 用恒定电流使电容器在规定电压和半额定电压间循环充放电 (25,000次) Capacitors cycles between specified voltage and half rated voltage under constant current at +25°C (25,000 cycles)	
	容量变化 Capacitance Change	初始测试值的±30% ±30% of initial measured value
	内阻 Internal Resistance	≤初始值的2倍 ≤2 times of initial specified value

规格若有任何变更将不予通知。如有产品安全或技术问题, 请即与我司业务部或代理商联系。
Specifications are subject to change without notice. Should a safety or technical concern arise regarding the product, please be sure to contact our sales offices or agents immediately.

壳号尺寸表 Case Size Table

端子 Terminal: RR

Safety vent for $\Phi \geq 6.3$

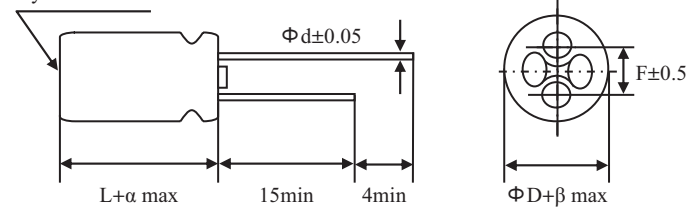

ΦD	10	12.5	16	18	22
F	5.0	5.0	7.5	7.5	10.0
Φd	0.6	0.6	0.8	0.8	1.0
α	2.0				
β	(D<20)0.5		(D≥20)1.0		

端子 Terminal: SZ

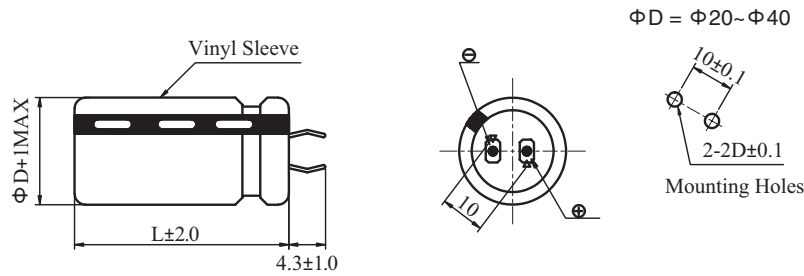

Unit: mm

电性能列表 Characteristics List

产品编码 Part Number	额定电压 Rated Voltage (V.DC)	额定容量 Rated Cap. (F)	尺寸 Size 直径 x 长度 $\Phi D \times L$ (mm)	直流等值阻抗 ESR, DC (m Ω) (max)	交流等值阻抗 ESR, AC (m Ω) (max) at 1kHz/20°C	漏电流 Leakage Current (mA/72hrs)
DRC106S03G20RR	2.3	10	10 x 20	400	220	0.050
DRC226S03I20RR	2.3	22	12.5 x 20	170	120	0.065
DRC306S03I25RR	2.3	30	12.5 x 25	160	100	0.085
DRC506S03K25RR	2.3	50	16 x 25	100	60	0.110
DRC706S03K35RR	2.3	70	16 x 35	85	50	0.150
DRC127S03L40RR	2.3	120	18 x 40	65	35	0.400
DRC227S03N47RR	2.3	220	22 x 47	45	25	0.900
DRC407S03P45SZ	2.3	400	30 x 45	25	20	2.000
DRC607S03P60SZ	2.3	600	30 x 60	20	15	4.000
DRC807S03Q70SZ	2.3	800	35 x 70	15	10	7.200

规格若有任何变更将不予通知。如有产品安全或技术问题，请即与我司业务部或代理商联系。
Specifications are subject to change without notice. Should a safety or technical concern arise regarding the product, please be sure to contact our sales offices or agents immediately.

特性 Features

- 高能量密度
(2倍于2.5V/2.7V 超级电容器) Higher energy density
(2 times of 2.5V/2.7V EDLC)
- 快速充电/放电 Quick charge & discharge
- 符合RoHS无铅要求 RoHS directive compliant
- 漏电流比DRC系列更低 Lower leakage current than DRC series

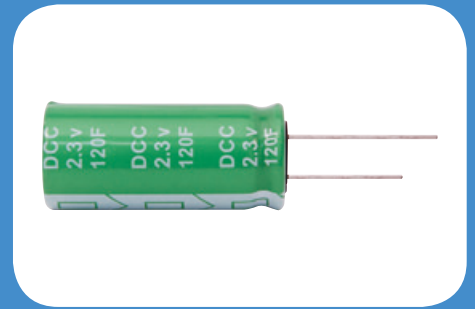

推荐应用领域 Recommended Applications

- 太阳能地砖灯 Solar Brick Light
- 再生能源储能系统 Renewable Energy Storage Systems

规格 Specifications

项目 Item	性能 Performance Characteristics	
温度 Temperature		
工作温度范围 Operating Temperature Range	-25°C to +70°C	
容量 Capacitance		
容量范围 Nominal Capacitance Range	10F to 220F	
容量公差 Capacitance Tolerance	±20% or -20%~+50%	
电压 Voltage		
额定电压 Rated Voltage	2.3 V.DC	
浪涌电压 Surge Voltage	2.5 V.DC	
最大工作电压 Maximum Operating Voltage	2.3 V.DC	
阻抗 Resistance		
直流等值阻抗 ESR, DC	详见附件电性能列表 Please see the attached characteristics list	
交流等值阻抗 ESR, AC	详见附件电性能列表 (1kHz/20°C) Please see the attached characteristics list (1kHz/20°C)	
寿命 Lifespan		
贮存寿命 Shelf Life	+70°C下无负荷贮存1,000小时后电容器符合规定的限值 After 1,000 hours storage at +70°C without load, the capacitor shall meet the specified limits for endurance.	
耐用性 Endurance	+70°C下采用额定电压1,000小时后电容器符合以下限定值 After 1,000 hours application of rated voltage at +70°C, the capacitor shall meet the following limits.	
	容量变化 Capacitance Change	初始测试值的±30% ±30% of initial measured value
	内阻 Internal Resistance	≤初始值的2倍 ≤2 times of initial specified value
循环次数 Cycles		
循环次数 Cycles	在+25°C下, 用恒定电流使电容器在规定电压和半额定电压间循环充放电 (25,000次) Capacitors cycles between specified voltage and half rated voltage under constant current at +25°C (25,000 cycles)	
	容量变化 Capacitance Change	初始测试值的±30% ±30% of initial measured value
	内阻 Internal Resistance	≤初始值的2倍 ≤2 times of initial specified value

规格若有任何变更将不予通知。如有产品安全或技术问题, 请即与我司业务部或代理商联系。
Specifications are subject to change without notice. Should a safety or technical concern arise regarding the product, please be sure to contact our sales offices or agents immediately.

壳号尺寸表 Case Size Table

端子 Terminal: RR

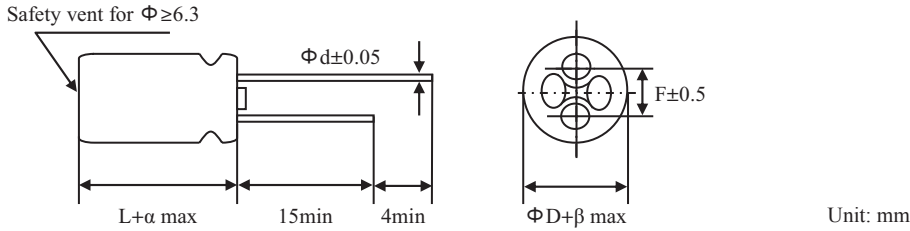

ΦD	10	12.5	16	18	22
F	5.0	5.0	7.5	7.5	10.0
Φd	0.6	0.6	0.8	0.8	1.0
α	2.0				
β	(D < 20) 0.5		(D ≥ 20) 1.0		

电性能列表 Characteristics List

产品编码 Part Number	额定电压 Rated Voltage (V.DC)	额定容量 Rated Cap. (F)	尺寸 Size 直径 x 长度 ΦD x L (mm)	直流等值阻抗 ESR, DC (mΩ) (max)	交流等值阻抗 ESR, AC (mΩ) (max) at 1kHz/20°C	漏电流 Leakage Current (mA/72hrs)
DCC106S03G20RR	2.3	10	10 x 20	400	220	0.040
DCC226S03G30RR	2.3	22	10 x 30	170	120	0.050
DCC306S03I25RR	2.3	30	12.5 x 25	160	100	0.065
DCC506S03K25RR	2.3	50	16 x 25	100	60	0.085
DCC706S03K35RR	2.3	70	16 x 35	85	50	0.120
DCC127S03L40RR	2.3	120	18 x 40	65	35	0.300
DCC227S03N47RR	2.3	220	22 x 47	45	25	0.700

规格若有任何变更将不予通知。如有产品安全或技术问题，请即与我司业务部或代理商联系。
Specifications are subject to change without notice. Should a safety or technical concern arise regarding the product, please be sure to contact our sales offices or agents immediately.

特性 Features

- 小型化, 大容量, 耐高温
Miniaturized, high capacitance and high temperature
- 快速充电/放电 Quick charge & discharge
- 符合RoHS无铅要求 RoHS directive compliant

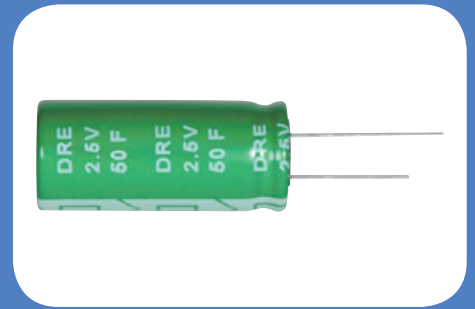

推荐应用领域 Recommended Applications

- 消费类电器 Consumer Electronics • 工业与汽车 Industrial and Automation
- 便携式电源工具 Portable Power Tools • 再生能源储能系统 Renewable Energy Storage Systems
- 短期UPS (不间断电源) Short Term UPS (Uninterruptible Power Supply)

规格 Specifications

项目 Item	性能 Performance Characteristics	
温度 Temperature		
工作温度范围 Operating Temperature Range	-25°C to +70°C	
容量 Capacitance		
容量范围 Nominal Capacitance Range	0.3F to 650F	1200F to 3800F
容量公差 Capacitance Tolerance	±20% or -20%~+50%	-10%~+20%
电压 Voltage		
额定电压 Rated Voltage	2.5 V.DC	
浪涌电压 Surge Voltage	2.7 V.DC	
最大工作电压 Maximum Operating Voltage	2.5 V.DC	
阻抗 Resistance		
直流等值阻抗 ESR, DC	详见附件电性能列表 (表1) Please see the attached characteristics list (table 1)	
交流等值阻抗 ESR, AC	详见附件电性能列表 (1kHz/20°C) (表1) Please see the attached characteristics list (1kHz/20°C) (table 1)	
功率 Power		
功率 Pv	详见附件电性能列表 (表2) Please see the attached characteristics list (table 2)	
能量 Energy		
能量密度 Energy Density (E _{max})	详见附件电性能列表 (表2) Please see the attached characteristics list (table 2)	
寿命 Lifespan		
贮存寿命 Shelf Life	+70°C下无负荷贮存1,000小时后电容器符合规定的限值 After 1,000 hours storage at +70°C without load, the capacitor shall meet the specified limits for endurance.	
耐用性 Endurance	+70°C下采用额定电压1,000小时后电容器符合以下限定值 After 1,000 hours application of rated voltage at +70°C, the capacitor shall meet the following limits.	
	容量变化 Capacitance Change	初始测试值的±30% ±30% of initial measured value
	内阻 Internal Resistance	≤初始值的2倍 ≤2 times of initial specified value
循环次数 Cycles		
循环次数 Cycles	在+25°C下, 用恒定电流使电容器在规定电压和半额定电压间循环充放电 (500,000次) Capacitors cycles between specified voltage and half rated voltage under constant current at +25°C (500,000 cycles)	
	容量变化 Capacitance Change	初始测试值的±30% ±30% of initial measured value
	内阻 Internal Resistance	≤初始值的2倍 ≤2 times of initial specified value

规格若有任何变更将不予通知。如有产品安全或技术问题, 请即与我司业务部或代理商联系。
Specifications are subject to change without notice. Should a safety or technical concern arise regarding the product, please be sure to contact our sales offices or agents immediately.

壳号尺寸表 Case Size Table

端子 Terminal: RR

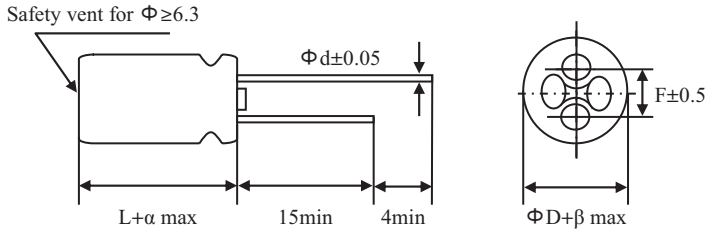

ΦD	8(L<20)	8(L≥20)	10	12.5	16	18
F	3.5	3.5	5.0	5.0	7.5	7.5
Φd	0.5	0.6	0.6	0.6	0.8	0.8
α	(L<20)1.5		(L≥20)2.0			
β	(D<20)0.5		(D≥20)1.0			

端子 Terminal: SZ

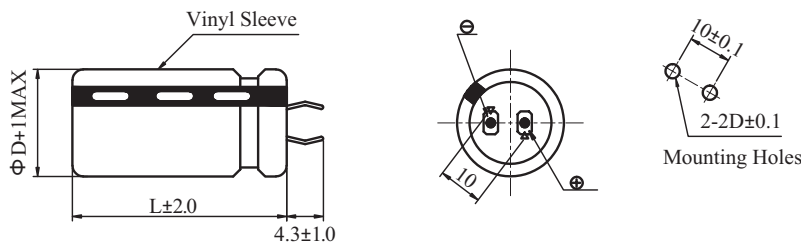

端子 Terminal: AD (350F)

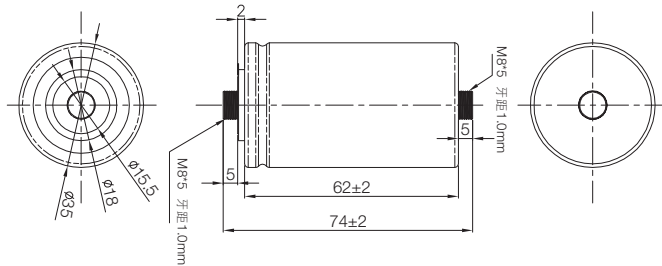

端子 Terminal: A4 (3000F)

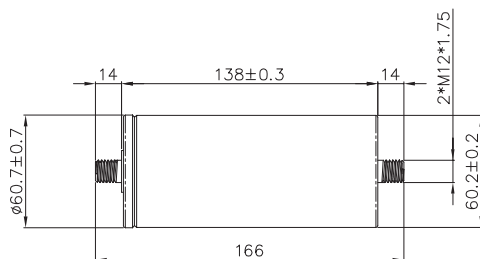

端子 Terminal: A3 (3000F)

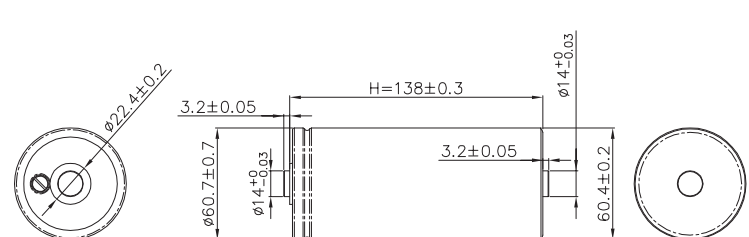

Unit: mm

规格若有任何变更将不予通知。如有产品安全或技术问题，请即与我司业务部或代理商联系。
Specifications are subject to change without notice. Should a safety or technical concern arise regarding the product, please be sure to contact our sales offices or agents immediately.

电性能列表 Characteristics List

• 表1 Table 1

产品编码 Part Number	额定电压 Rated Voltage (V.DC)	额定容量 Rated Cap. (F)	尺寸 Size 直径 x 长度 ΦD x L (mm)	直流等值 阻抗 ESR, DC (mΩ) (max)	交流等值 阻抗 ESR, AC (mΩ) (max) at 1kHz/20°C	漏电流 Leakage Current (mA/72hrs)	短路电流 Short Circuit Current (A)	最大 持续电流 Maximum Continuous Current (A) (ΔT=15°C)	最大 峰值电流 Maximum Peak Current (Isc) (A)
DRE304S0EC11RR	2.5	0.3	4 x 11	2000	1500	0.006	1.25	0.2	0.50
DRE105S0EF12RR	2.5	1.0	8 x 12	1000	500	0.008	2.5	0.3	0.63
DRE205S0EF16RR	2.5	2.0	8 x 16	550	350	0.010	4.5	0.5	1.19
DRE305S0EF20RR	2.5	3.0	8 x 20	410	260	0.012	7.8	0.7	1.91
DRE335S0EG20RR	2.5	3.3	10 x 20	320	200	0.014	7.8	0.8	2.01
DRE475S0EG20RR	2.5	4.7	10 x 20	290	180	0.016	8.6	0.8	2.49
DRE705S0EG25RR	2.5	7.0	10 x 25	220	140	0.020	11.3	1.0	3.44
DRE106S0EG30RR	2.5	10	10 x 30	165	110	0.030	16.6	1.3	5.00
DRE106S0EI25RR	2.5	10	12.5 x 25	160	100	0.030	15.6	1.3	4.81
DRE226S0EK25RR	2.5	22	16 x 25	100	60	0.060	25.0	1.9	8.59
DRE306S0EK30RR	2.5	30	16 x 30	70	40	0.070	35.7	2.5	12.1
DRE506S0EL40RR	2.5	50	18 x 40	50	30	0.160	50.0	3.6	17.9
DRE107S0EL60RR	2.5	100	18 x 60	35	25	0.300	71	5.2	27.8
DRE107S0EN45SZ	2.5	100	22 x 45	35	25	0.300	71	5.2	27.8
DRE157S0EO55SZ	2.5	150	25 x 55	30	22	0.550	83	6.4	34.1
DRE207S0EP50SZ	2.5	200	30 x 50	25	20	0.700	100	7.4	41.7
DRE257S0EP55SZ	2.5	250	30 x 55	22	18	0.800	114	8.3	48.1
DRE357S0EQ60SZ	2.5	350	35 x 60	15	12	1.000	167	11.3	70.0
DRE357S0EQ60AD	2.5	350	35 x 60	3	2.5	1.000	833	20.6	213
DRE657R0E660A4	2.5	650	60 x 60	0.95	0.80	2.300	2630	52.0	502
DRE128V0E680A4	2.5	1200	60 x 80	0.86	0.75	2.700	2907	57.0	739
DRE158V0E690A4	2.5	1500	60 x 90	0.69	0.60	3.000	3623	70.0	922
DRE188V0E61MA4	2.5	1800	60 x 110	0.65	0.55	4.000	3846	78.0	1036
DRE208V0E61NA4	2.5	2000	60 x 120	0.52	0.45	5.000	4808	90.0	1225
DRE258V0E61YA4	2.5	2500	60 x 138	0.49	0.42	5.500	5102	100.0	1398
DRE308V0E61YA4	2.5	*3000	60 x 138	0.50	0.45	7.000	5000	100.0	1500
DRE308V0E61EA4	2.5	3000	60 x 155	0.47	0.40	7.000	5319	110.0	1559
DRE358R0E61FA4	2.5	3500	60 x 165	0.41	0.35	7.500	6090	115.0	1771
DRE388R0E61FA4	2.5	3800	60 x 165	0.40	0.33	7.800	6250	130.0	1884

* High Pd (W/kg) and Energy Density (E_{max}(Wh/kg))

规格若有任何变更将不予通知。如有产品安全或技术问题，请即与我司业务部或代理商联系。
Specifications are subject to change without notice. Should a safety or technical concern arise regarding the product, please be sure to contact our sales offices or agents immediately.

电性能列表 Characteristics List

• 表2 Table 2

额定容量 Rated Capacitance (F)	0.3	1	2	3	3.3	4.7	7	10	10	22	30
尺寸 Size 直径 x 长度 ΦD x L (mm)	4 x 11	8 x 12	8 x 16	8 x 20	10 x 20	10 x 20	10 x 25	10 x 30	12.5 x 25	16 x 25	16 x 30
功率密度 (W/kg) Power Density (W/kg)	2000	794	1145	1473	1071	1151	1384	1458	1170	1036	1162
能量密度 Energy Density 最高能量值 Emax (Wh/kg)	1.0	0.9	1.5	1.6	1.3	1.8	2.5	2.5	2.2	2.6	2.8
最大能量 Maximum Energy 最高能量值 Emax (mAh)	0.26	0.87	1.74	2.60	2.86	4.08	6.08	8.68	8.68	19.10	26.0

额定容量 Rated Capacitance (F)	50	100	100	150	200	250	350	350	500	650
尺寸 Size 直径 x 长度 ΦD x L (mm)	18 x 40	18 x 60	22 x 45	25 x 55	30 x 50	30 x 55	35 x 60	35 x 60	35 x 95	60 x 60
功率密度 (W/kg) Power Density (W/kg)	1067	984	866	723	652	673	676	2631	534	3432
能量密度 Energy Density 最高能量值 Emax (Wh/kg)	3.1	4.0	3.5	3.8	3.8	4.3	4.1	3.2	3.7	2.5
最大能量 Maximum Energy 最高能量值 Emax (mAh)	43.4	86.8	86.80	130.20	173.60	217.00	303.80	303.80	434.03	225.70

额定容量 Rated Capacitance (F)	1200	1500	1800	2000	2500	*3000	3000	3500	3800
尺寸 Size 直径 x 长度 ΦD x L (mm)	60 x 80	60 x 90	60 x 110	60 x 120	60 x 138	60 x 138	60 x 155	60 x 165	60 x 165
功率密度 (W/kg) Power Density (W/kg)	2754	3113	2778	3162	2878	2362	2312	2576	2568
能量密度 Energy Density 最高能量值 Emax (Wh/kg)	3.3	3.7	3.8	3.8	4.1	4.1	3.8	4.3	4.5
最大能量 Maximum Energy 最高能量值 Emax (mAh)	1041.67	1302.08	1562.5	1736.11	2170.14	2604.2	2604.2	1215.3	1319.4

* High Pd (W/kg) and Energy Density (Emax(Wh/kg))

其它技术信息 Additional Technical Information

Ic = 25°C下72小时后的漏电流

Ic = leakage current after 72 hours at 25°C

Isc = 短路电流 (最大峰值电流)

Isc = short circuit current (maximum peak current)

R_{DC} = 直流内阻 (DC)

R_{DC} = internal resistance (DC)

M = 电容器总重 (kg)

M = capacitor mass (kg)

功率密度

最高能量值

最大峰值电流 (1秒)

$Pd=(0.12xU^2/R_{DC})/M$

$E_{max}=(0.5CU^2)/(3600xM)$

Maximum Peak Current (1 sec)= $0.5U/(ESR_{DC}+1/C)$

规格若有任何变更将不予通知。如有产品安全或技术问题，请即与我司业务部或代理商联系。
Specifications are subject to change without notice. Should a safety or technical concern arise regarding the product, please be sure to contact our sales offices or agents immediately.

特性 Features

- 小型化，大容量，耐高温
Miniaturized, high capacitance and high temperature
- 快速充电/放电
Quick charge & discharge
- 符合RoHS无铅要求
RoHS directive compliant

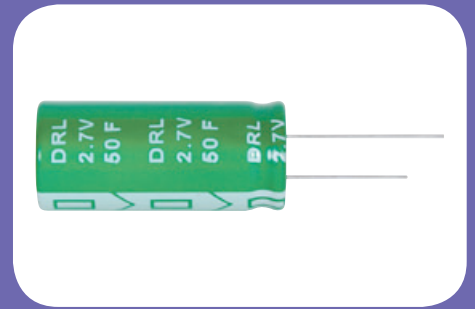

推荐应用领域 Recommended Applications

- 消费类电器 Consumer Electronics
- 工业与汽车 Industrial and Automation
- 便携式电源工具 Portable Power Tools
- 再生能源储能系统 Renewable Energy Storage Systems
- 短期UPS (不间断电源) Short Term UPS (Uninterruptible Power Supply)

规格 Specifications

项目 Item	性能 Performance Characteristics	
温度 Temperature		
工作温度范围 Operating Temperature Range	-40°C to +60°C	
容量 Capacitance		
容量范围 Nominal Capacitance Range	0.3F to 650F	1200F to 3800F
容量公差 Capacitance Tolerance	±20% or -20%~+50%	-10%~+20%
电压 Voltage		
额定电压 Rated Voltage	2.7 V.DC	
浪涌电压 Surge Voltage	2.8 V.DC	
最大工作电压 Maximum Operating Voltage	2.7 V.DC	
阻抗 Resistance		
直流等值阻抗 ESR, DC	参见附件电性能列表 (表1) Please see the attached characteristics list (table 1)	
交流等值阻抗 ESR, AC	参见附件电性能列表 (1kHz/20°C) (表1) Please see the attached characteristics list (1kHz/20°C) (table 1)	
功率 Power		
功率 Pv	参见附件电性能列表 (表2) Please see the attached characteristics list (table 2)	
能量 Energy		
能量密度 Energy Density (E _{max})	参见附件电性能列表 (表2) Please see the attached characteristics list (table 2)	
寿命 Lifespan		
贮存寿命 Shelf Life	+60°C下无负荷贮存1,000小时后电容器符合规定的限值 After 1,000 hours storage at +60°C without load, the capacitor shall meet the specified limits for endurance.	
耐用性 Endurance	+60°C下采用额定电压1,000小时后电容器符合以下限定值 After 1,000 hours application of rated voltage at +60°C, the capacitor shall meet the following limits.	
	容量变化 Capacitance Change	初始测试值的±30% ±30% of initial measured value
	内阻 Internal Resistance	≤初始值的2倍 ≤2 times of initial specified value
循环次数 Cycles		
循环次数 Cycles	在+25°C下，用恒定电流使电容器在规定电压和半额定电压间循环充放电 (500,000次) Capacitors cycles between specified voltage and half rated voltage under constant current at +25°C (500,000 cycles)	
	容量变化 Capacitance Change	初始测试值的±30% ±30% of initial measured value
	内阻 Internal Resistance	≤初始值的2倍 ≤2 times of initial specified value

规格若有任何变更将不予通知。如有产品安全或技术问题，请即与我司业务部或代理商联系。
Specifications are subject to change without notice. Should a safety or technical concern arise regarding the product, please be sure to contact our sales offices or agents immediately.

壳号尺寸表 Case Size Table

端子 Terminal: RR

Safety vent for $\Phi \geq 6.3$

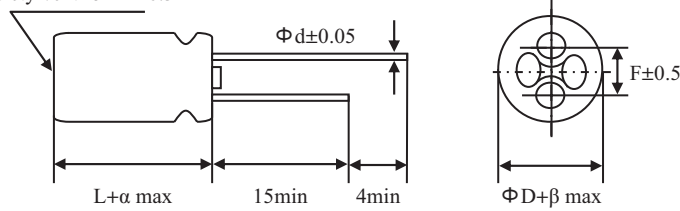

ΦD	8(L<20)	8(L≥20)	10	12.5	16	18
F	3.5	3.5	5.0	5.0	7.5	7.5
Φd	0.5	0.6	0.6	0.6	0.8	0.8
α	(L<20)1.5			(L≥20)2.0		
β	(D<20)0.5			(D≥20)1.0		

端子 Terminal: SC

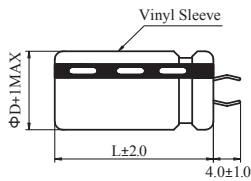

$\Phi D = \Phi 20 \sim \Phi 40$

端子 Terminal: SZ

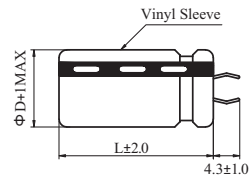

$\Phi D = \Phi 20 \sim \Phi 40$

端子 Terminal: AD (350F)

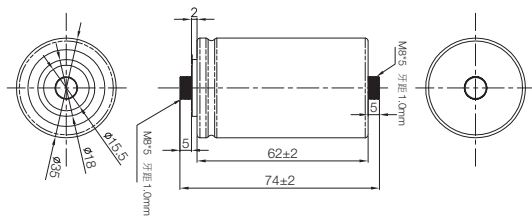

端子 Terminal: A4 (3000F)

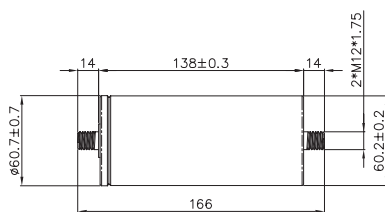

端子 Terminal: A3 (3000F)

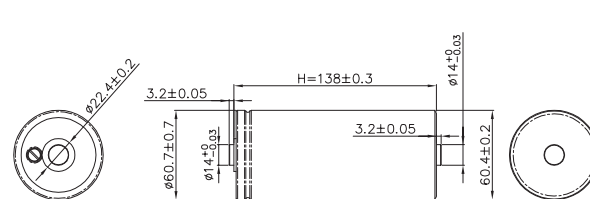

Unit: mm

规格若有任何变更将不予通知。如有产品安全或技术问题，请即与我司业务部或代理商联系。
Specifications are subject to change without notice. Should a safety or technical concern arise regarding the product, please be sure to contact our sales offices or agents immediately.

电性能列表 Characteristics List

• 表1 Table 1

产品编码 Part Number	额定电压 Rated Voltage (V.DC)	额定容量 Rated Cap. (F)	尺寸 Size 直径 x 长度 ΦD x L (mm)	直流等值阻抗 ESR, DC (mΩ) (max)	交流等值阻抗 ESR, AC (mΩ) (max) at 1kHz/20°C	漏电流 Leakage Current (mA/72hrs)	短路电流 Short Circuit Current (A)	最大持续电流 Maximum Continuous Current (A) (ΔT=15°C)	最大峰值电流 Maximum Peak Current (Isc) (A)
DRL304S0TC11RR	2.7	0.3	4 x 11	1500	1000	0.006	1.80	0.2	0.50
DRL105S0TF12RR	2.7	1.0	8 x 12	850	400	0.008	3.17	0.4	0.73
DRL205S0TF16RR	2.7	2.0	8 x 16	470	280	0.010	5.74	0.5	1.39
DRL305S0TF20RR	2.7	3.0	8 x 20	250	160	0.012	10.8	0.8	2.31
DRL335S0TG20RR	2.7	3.3	10 x 20	270	160	0.014	10.0	0.8	2.36
DRL475S0TG20RR	2.7	4.7	10 x 20	250	140	0.016	10.8	0.9	2.92
DRL705S0TG25RR	2.7	7.0	10 x 25	200	100	0.020	13.5	1.0	3.94
DRL106S0TG30RR	2.7	10	10 x 30	130	80	0.030	20.7	1.4	5.87
DRL106S0TI25RR	2.7	10	12.5 x 25	140	80	0.030	19.3	1.4	5.63
DRL226S0TK25RR	2.7	22	16 x 25	85	40	0.060	31.7	2.1	10.3
DRL306S0TK30RR	2.7	30	16 x 30	60	30	0.070	45.0	2.7	14.5
DRL506S0TL40RR	2.7	50	18 x 40	40	25	0.160	67.5	4.0	22.5
DRL107S0TL60RR	2.7	100	18 x 60	28	20	0.300	96.4	5.8	35.5
DRL107S0TN45SC	2.7	100	22 x 45	28	18	0.300	96.4	5.8	35.5
DRL157S0TO55SC	2.7	150	25 x 55	25	16	0.550	108.0	7.0	42.6
DRL207S0TP50SC	2.7	200	30 x 50	20	15	0.700	135.0	8.3	54.0
DRL257S0TP55SC	2.7	250	30 x 55	18	13	0.800	150.0	9.1	61.4
DRL357S0TQ60SC	2.7	350	35 x 60	12	10	1.000	225.0	12.7	90.9
DRL357S0TQ60AD	2.7	350	35 x 60	2.4	2	1.000	1125	23.1	256
DRL657R0T660A4	2.7	650	60 x 60	0.8	0.65	2.300	3370	62.0	577
DRL128V0T680A4	2.7	1200	60 x 80	0.7	0.60	2.700	3857	64.0	880
DRL158V0T690A4	2.7	1500	60 x 90	0.6	0.50	3.000	4500	75.0	1065
DRL188V0T61MA4	2.7	1800	60 x 110	0.55	0.45	4.000	4909	85.0	1221
DRL208V0T61NA4	2.7	2000	60 x 120	0.45	0.40	5.000	6000	100.0	1421
DRL258V0T61YA4	2.7	2500	60 x 138	0.42	0.36	5.500	6429	106.0	1646
DRL308V0T61YA4	2.7	*3000	60 x 138	0.43	0.38	7.000	6279	105.0	1768
DRL308V0T61EA4	2.7	3000	60 x 155	0.40	0.35	7.000	6750	116.0	1840
DRL358R0T61FA4	2.7	3500	60 x 165	0.29	0.24	7.500	9300	123.0	2344
DRL388R0T61FA4	2.7	3800	60 x 165	0.28	0.22	7.800	9640	147.0	2485

* High Pd (W/kg) and Energy Density (E_{max}(Wh/kg))

规格若有任何变更将不予通知。如有产品安全或技术问题，请即与我司业务部或代理商联系。
Specifications are subject to change without notice. Should a safety or technical concern arise regarding the product, please be sure to contact our sales offices or agents immediately.

电性能列表 Characteristics List

• 表2 Table 2

额定容量 Rated Capacitance (F)	0.3	1	2	3	3.3	4.7	7	10	10	22	30
尺寸 Size 直径 x 长度 ΦD x L (mm)	4 x 11	8 x 12	8 x 16	8 x 20	10 x 20	10 x 20	10 x 25	10 x 30	12.5 x 25	16 x 25	16 x 30
功率密度 (W/kg) Power Density (W/kg)	2333	1338	1756	2647	1580	1645	1934	2057	1755	1650	1768
能量密度 Energy Density 最高能量值 Emax (Wh/kg)	1.2	1.3	1.9	2.3	1.6	2.2	3.1	3.1	2.8	3.6	3.7
最大能量 Maximum Energy 最高能量值 Emax (mAh)	0.31	1.01	2.03	3.04	3.34	4.76	7.09	10.1	10.1	22.3	30.4

额定容量 Rated Capacitance (F)	50	100	100	150	200	250	350	350	500	650
尺寸 Size 直径 x 长度 ΦD x L (mm)	18 x 40	18 x 60	22 x 45	25 x 55	30 x 50	30 x 55	35 x 60	35 x 60	35 x 95	60 x 60
功率密度 (W/kg) Power Density (W/kg)	1770	1625	1595	1144	1092	1078	1115	4288	848	5468
能量密度 Energy Density 最高能量值 Emax (Wh/kg)	4.1	5.3	5.2	5.0	5.1	5.6	5.4	4.16	4.9	3.3
最大能量 Maximum Energy 最高能量值 Emax (mAh)	50.6	101	101.00	151.80	202.50	253.10	354.3	354.3	506.25	243.80

额定容量 Rated Capacitance (F)	1200	1500	1800	2000	2500	*3000	3000	3500	3800
尺寸 Size 直径 x 长度 ΦD x L (mm)	60 x 80	60 x 90	60 x 110	60 x 120	60 x 138	60 x 138	60 x 155	60 x 165	60 x 165
功率密度 (W/kg) Power Density (W/kg)	4537	4773	4317	4813	4425	3614	3610	4571	4595
能量密度 Energy Density 最高能量值 Emax (Wh/kg)	4.4	5.0	4.9	5.0	5.4	5.4	5.0	5.4	5.7
最大能量 Maximum Energy 最高能量值 Emax (mAh)	1215.0	1518.8	1822.5	2025.00	2531.25	3037.5	3037.5	1312	1425.0

* High Pd (W/kg) and Energy Density (Emax(Wh/kg))

其它技术信息 Additional Technical Information

Ic = 25°C下72小时后的漏电流

Ic = leakage current after 72 hours at 25°C

Isc = 短路电流 (最大峰值电流)

Isc = short circuit current (maximum peak current)

R_{DC} = 直流内阻 (DC)

R_{DC} = internal resistance (DC)

M = 电容器总重 (kg)

M = capacitor mass (kg)

功率密度

最高能量值

最大峰值电流 (1秒)

$Pd=(0.12 \times U^2 / R_{DC}) / M$

$E_{max}=(0.5CU^2)/(3600 \times M)$

Maximum Peak Current (1 sec)= $0.5U/(ESR_{DC}+1/C)$

认证 Certifications : UL810a  (File No. MH49178)

规格若有任何变更将不予通知。如有产品安全或技术问题，请即与我司业务部或代理商联系。
Specifications are subject to change without notice. Should a safety or technical concern arise regarding the product, please be sure to contact our sales offices or agents immediately.

特性 Features

- 小型化，大容量，耐高温
Miniaturized, high capacitance and high temperature
- 快速充电/放电 Quick charge & discharge
- 符合RoHS无铅要求 RoHS directive compliant

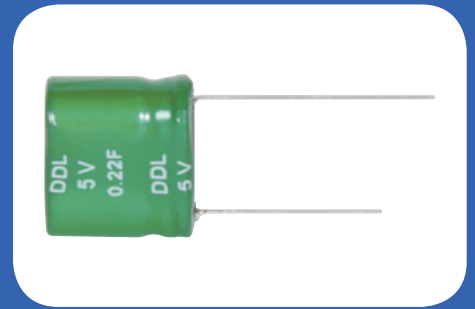

推荐应用领域 Recommended Applications

- 消费类电器 Consumer Electronics • 工业与汽车 Industrial and Automation
- 便携式电源工具 Portable Power Tools • 再生能源储能系统 Renewable Energy Storage Systems
- 短期UPS (不间断电源) Short Term UPS (Uninterruptible Power Supply)

规格 Specifications

项目 Item	性能 Performance Characteristics	
温度 Temperature		
工作温度范围 Operating Temperature Range	-40°C to +60°C	
容量 Capacitance		
容量范围 Nominal Capacitance Range	0.22F to 11F	
容量公差 Capacitance Tolerance	±20% or -20%~+50%	
电压 Voltage		
额定电压 Rated Voltage	5.0 V.DC	
浪涌电压 Surge Voltage	5.5 V.DC	
最大工作电压 Maximum Operating Voltage	5.0 V.DC	
阻抗 Resistance		
交流等值阻抗 ESR, AC	详见附件电性能列表 (1kHz/20°C) Please see the attached characteristics list (1kHz/20°C)	
寿命 Lifespan		
贮存寿命 Shelf Life	+60°C下无负荷贮存1,000小时后电容器符合规定的限值 After 1,000 hours storage at +60°C without load, the capacitor shall meet the specified limits for endurance.	
耐用性 Endurance	+60°C下采用额定电压1,000小时后电容器符合以下限定值 After 1,000 hours application of rated voltage at +60°C, the capacitor shall meet the following limits.	
	容量变化 Capacitance Change	初始测试值的±30% ±30% of initial measured value
	内阻 Internal Resistance	≤初始值的2倍 ≤2 times of initial specified value
循环次数 Cycles		
循环次数 Cycles	在+25°C下，用恒定电流使电容器在规定电压和半额定电压间循环充放电 (500,000次) Capacitors cycles between specified voltage and half rated voltage under constant current at +25°C (500,000 cycles)	
	容量变化 Capacitance Change	初始测试值的±30% ±30% of initial measured value
	内阻 Internal Resistance	≤初始值的2倍 ≤2 times of initial specified value

规格若有任何变更将不予通知。如有产品安全或技术问题，请即与我司业务部或代理商联系。
Specifications are subject to change without notice. Should a safety or technical concern arise regarding the product, please be sure to contact our sales offices or agents immediately.

壳号尺寸表 Case Size Table

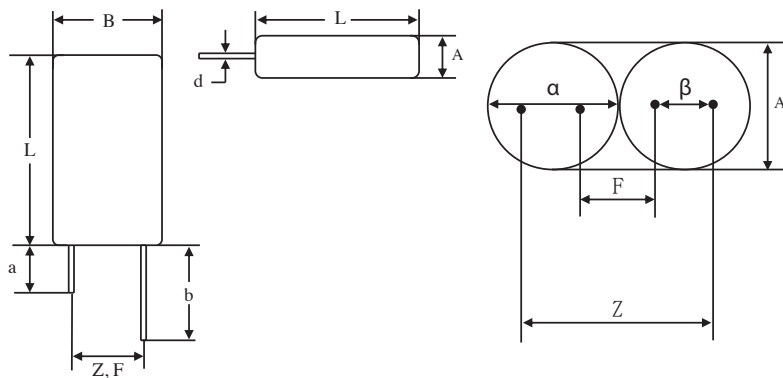

注：长导针为正极

Note: Longer lead is positive

尺寸 Dimensions (mm)

尺寸代码 Size Code	A max.	B max.	L max.	d ±0.05	a min.	b min.	Z=α+β ±0.50	F=α-β ±0.50
F1E	9.0	17.5	15.5	0.50	15.0	19.0	11.80	4.80
F1J	9.0	17.5	19.5	0.50	15.0	19.0	11.80	4.80
F2C	9.0	17.5	23.5	0.60	15.0	19.0	11.80	4.80
G2C	11.0	21.5	23.5	0.60	15.0	19.0	15.30	5.30
I2C	13.5	30	23.5	0.80	15.0	19.0	22.20	12.20
K29	20.0	40	29	0.80	15.0	19.0	26.80	11.80

电性能列表 Characteristics List

产品编码 Part Number	额定电压 Rated Voltage (V.DC)	额定容量 Rated Cap. (F)	尺寸 Size (mm) 宽度 x 长度 x 高度 Width x Length x Height	交流等值阻抗 ESR, AC (Ω) (max) at 1kHz/20°C	漏电流 Leakage Current (mA/72hrs)
DDL224S0HF1ERR	5.0	0.22	9 x 17.5 x 15.5	2.50	0.060
DDL474S0HF1ERR	5.0	0.47	9 x 17.5 x 15.5	2.00	0.080
DDL105S0HF1JRR	5.0	1.00	9 x 17.5 x 19.5	1.05	0.090
DDL155S0HF2CRR	5.0	1.50	9 x 17.5 x 23.5	0.60	0.180
DDL255S0HG2CRR	5.0	2.50	11 x 21.5 x 23.5	0.54	0.200
DDL405S0HI2CRR	5.0	4.00	13.5 x 30 x 23.5	0.42	0.250
DDL805S0HK29RR	5.0	8.00	20 x 40 x 29	0.20	0.350
DDL126S05K29RR	5.0	12.00	20 x 40 x 29	0.18	0.550

规格若有任何变更将不予通知。如有产品安全或技术问题，请即与我司业务部或代理商联系。
Specifications are subject to change without notice. Should a safety or technical concern arise regarding the product, please be sure to contact our sales offices or agents immediately.

总公司 HEAD OFFICE

香港

HONG KONG

万裕电子有限公司
香港柴湾嘉业街10号
益高工业大厦16字楼

Man Yue Electronics Co., Ltd.

16/F., Yiko Industrial Building,
10 Ka Yip Street, Chai Wan, Hong Kong
电话 TEL: (852) 2897 5277
传真 FAX: (852) 2558 6299

分公司 BRANCH OFFICE

香港

HONG KONG

三信电子零件有限公司

Samxon Electronic Components Ltd.

富华德电子有限公司

**Forward Electronics
Company Limited.**

香港柴湾嘉业街10号
益高工业大厦16字楼
16/F., Yiko Industrial Building,

10 Ka Yip Street, Chai Wan, Hong Kong
电话 TEL: (852) 2897 5277
传真 FAX: (852) 2558 6299

台湾

TAIWAN

香港商万裕国际电子有限公司台湾分公司

台湾新北市23553中和区

连城路258号13楼之1

邮政编码: 23553

Man Yue Electronics Company Limited

Taiwan Branch (H.K.)

13F-1, No. 258 Liancheng Road,
Zhonghe District, New Taipei City,
Taiwan 23553, R.O.C.

Postal Code: 23553

电话 TEL: 886 (02) 8227 2227

传真 FAX: 886 (02) 8227 2226

中国深圳 SHENZHEN, CHINA

万晋电子(深圳)有限公司

中国深圳市罗湖区

宝安南路2014号振业大厦B座917A·B房

邮政编码: 518000

Man Jin Electronics (Shenzhen) Co., Ltd.

Rm 917A-B, Block B, 9/F, Zhenye Tower,

2014 Baoan South Road,

Luohu, Shenzhen City,

Guangdong Province, PR China

Postal Code: 518000

电话 TEL: 86 (755) 2586 2216

传真 FAX: 86 (755) 2586 2239

中国上海

SHANGHAI, CHINA

万发国际贸易(上海)有限公司

中国江苏省无锡市锡山经济开发区

东亭镇春晖东路148号

邮政编码: 214101

Man Fat International Trading

(Shanghai) Co., Ltd.

148 Chunhui East Road, Dongting Town,

Xishan Economic Development Zone,

Wuxi, Jiangsu Province, PR China

Postal Code: 214101

电话 TEL: 86 (510) 8866 2688

传真 FAX: 86 (510) 8865 2933

中国上海市宝山区

共和新路4995号611室

邮政编码: 200435

Room 611,

No.4995 Gong He Xin Road,

Baoshan District,

Shanghai, PR China

Postal Code: 200435

电话 TEL: 86 (021) 6639 2180

传真 FAX: 86 (021) 6639 2180

中国厂址 PRC MANUFACTURING PLANTS

中国东莞

DONGGUAN, CHINA

万裕三信电子(东莞)有限公司

Samxon Electronics (Dongguan) Co., Ltd.

富华德电子(东莞)有限公司

**Forward Electronics (Dongguan)
Company Limited**

中国广东省东莞市长安镇乌沙村

兴发南路新星工业园

邮政编码: 523857

Xin Xing Industrial Area,

Xing Fa South Road, Wu Sha Village,

Changan Town, Dongguan,

Guangdong Province, PR China

Postal Code: 523857

电话 TEL: 86 (769) 8228 6000 / 8532 3339

传真 FAX: 86 (769) 8541 6401