

# Electronic housing - ME 22,5 UT/FE BUS/10 BK - 2854254

Please be informed that the data shown in this PDF Document is generated from our Online Catalog. Please find the complete data in the user's documentation. Our General Terms of Use for Downloads are valid (<http://download.phoenixcontact.com>)



Housing base, 10-position integrated cross connector for parallel through contacting

The illustration shows the green product version

## Product Features

- 2 optional serial contacts (daisy chain)
- Can be snapped onto standard NS 35/7,5 and NS 35/15 DIN rails
- Gold contacts for data transmission and power supply (125 V, 8 A)
- Supply via standard MINI COMBICON plug

## Key commercial data

|                         |               |
|-------------------------|---------------|
| <b>package_quantity</b> | 10            |
| <b>GTIN</b>             | 4017918461362 |

## classifications

### eCl@ss

|                   |          |
|-------------------|----------|
| <b>eCl@ss 4.0</b> | 27180401 |
| <b>eCl@ss 4.1</b> | 27180401 |
| <b>eCl@ss 5.0</b> | 27180506 |
| <b>eCl@ss 5.1</b> | 27180506 |
| <b>eCl@ss 6.0</b> | 27180802 |
| <b>eCl@ss 7.0</b> | 27182702 |
| <b>eCl@ss 8.0</b> | 27182702 |

### ETIM

|                 |          |
|-----------------|----------|
| <b>ETIM 2.0</b> | EC001031 |
| <b>ETIM 3.0</b> | EC001031 |
| <b>ETIM 4.0</b> | EC001031 |
| <b>ETIM 5.0</b> | EC001031 |

### UNSPSC

|                      |          |
|----------------------|----------|
| <b>UNSPSC 6.01</b>   | 31261501 |
| <b>UNSPSC 7.0901</b> | 31261501 |
| <b>UNSPSC 11</b>     | 31261501 |
| <b>UNSPSC 12.01</b>  | 31261501 |
| <b>UNSPSC 13.2</b>   | 31261501 |

# Electronic housing - ME 22,5 UT/FE BUS/10 BK - 2854254

## approvals

---

UL Recognized / cUL Recognized / cULus Recognized /

---

### Approval details

UL Recognized

cUL Recognized

| Usegroups                  | B     | D     |
|----------------------------|-------|-------|
| Nominal voltage UN         | 300 V | 300 V |
| Nominal current IN         | 8 A   | 8 A   |
| mm <sup>2</sup> /AWG/kcmil |       |       |

cULus Recognized

## accessories

### Coding element

CR-MSTB - 1734401



---

CP-MSTB - 1734634



---

## Mounting material

## Electronic housing - ME 22,5 UT/FE BUS/10 BK - 2854254

accessories

ME-SAS - 2853899



ME DH27 NS 35 - 2908760



ME DH36 NS 35 - 2909895



ME LPZS - 2906911



**Filler plug**

ME B-22,5 MKDSO GN - 2907143



## Electronic housing - ME 22,5 UT/FE BUS/10 BK - 2854254

### accessories

ME B-22,5 MSTBO GN - 2907156



---

ME B-SA/NS 35 - 2935959



---

ME B-KA - 2854173



---

### accessories

ME B-SA/NS 35 BK - 2713052

---

ME B-KA BK - 2869320

---

## Electronic housing - ME 22,5 UT/FE BUS/10 BK - 2854254

accessories

ME B-22,5 MKDSO BK - 2908456

---

ME B-22,5 MSTBO BK - 2909659

---

MCVR 1,5/ 5-ST-3,81 AU - 1893203



---

Drawings

# Electronic housing - ME 22,5 UT/FE BUS/10 BK - 2854254

Dimensioned drawing

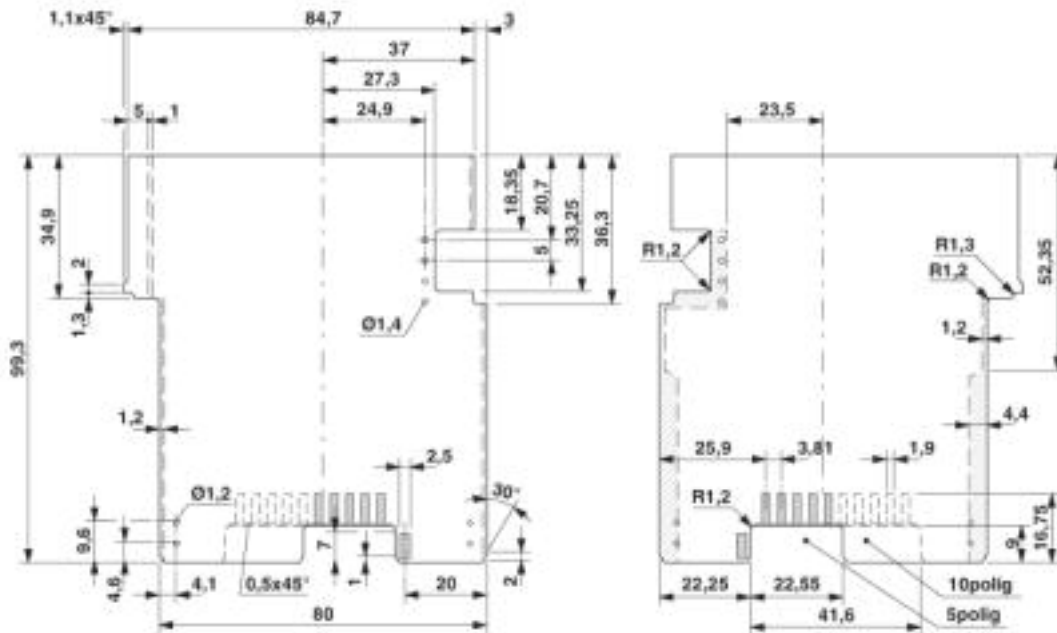

Dimensional drawing of the ME.../BUS5 and ME.../BUS10 printed circuit board if the single-level upper part is used

Dimensioned drawing

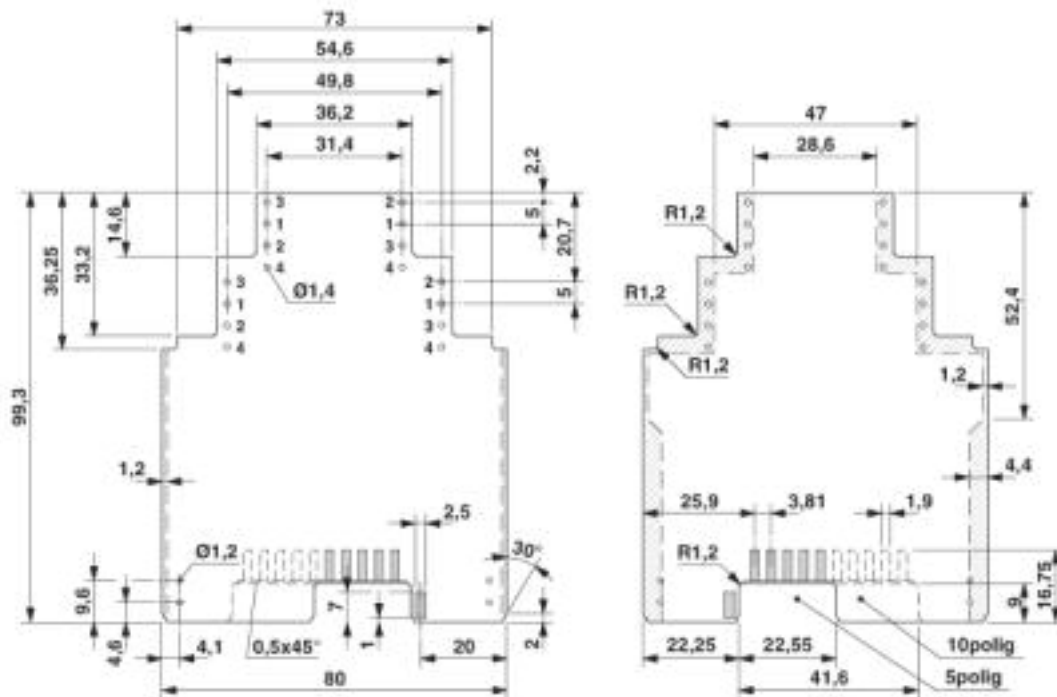

Dimensional drawing of the ME.../BUS5 and ME.../BUS10 printed circuit board if the double-level upper part is used

# Electronic housing - ME 22,5 UT/FE BUS/10 BK - 2854254

Dimensioned drawing

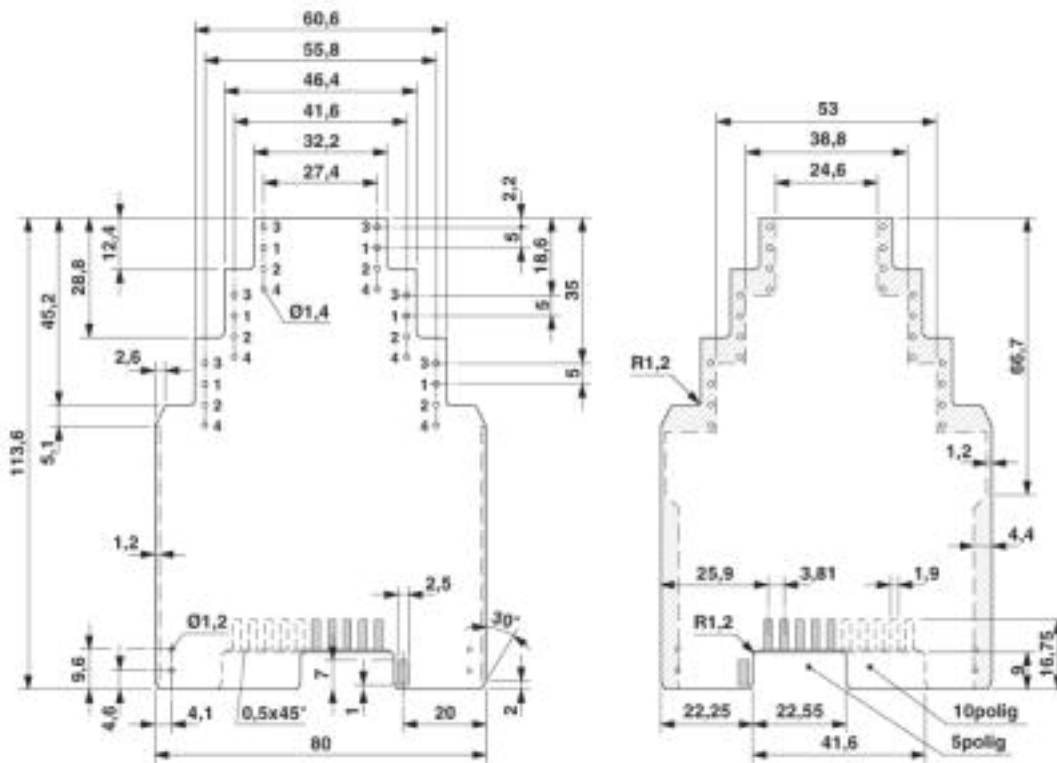

Dimensional drawing of the ME.../BUS5 and ME.../BUS10 printed circuit board if the triple-level upper part is used

# Electronic housing - ME 22,5 UT/FE BUS/10 BK - 2854254

Dimensioned drawing

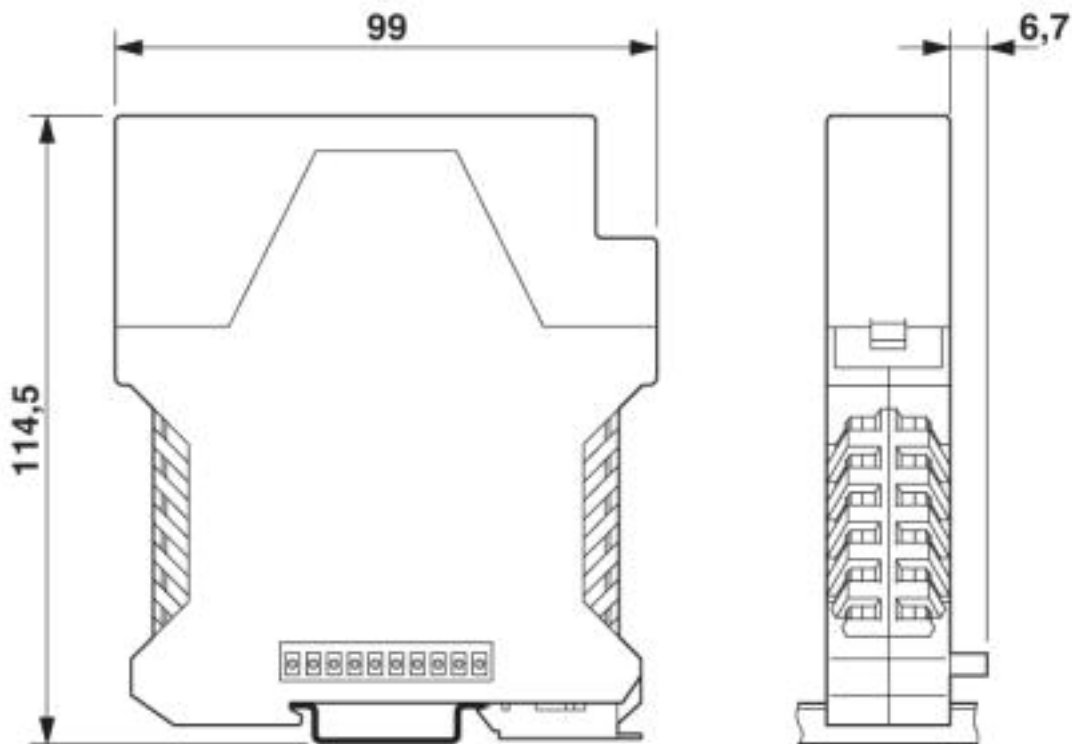

Dimensions of the electronics housing ME.../BUS5 and ME.../BUS10 with single-level upper part



# Electronic housing - ME 22,5 UT/FE BUS/10 BK - 2854254

Dimensioned drawing

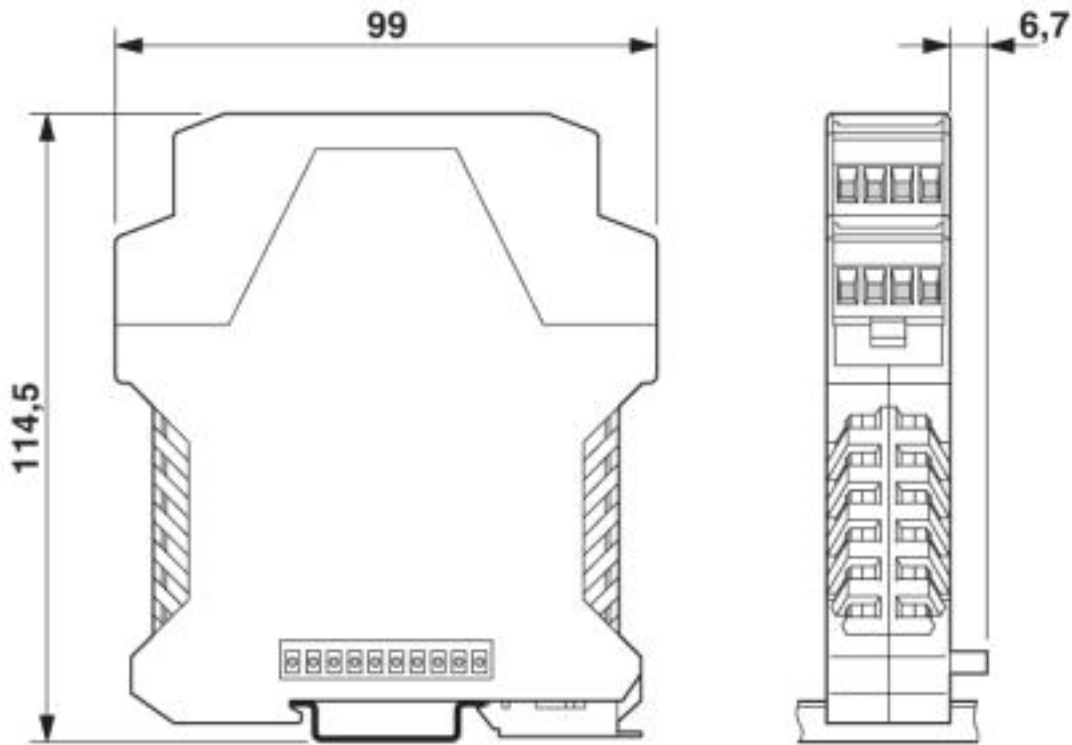

Dimensions of the electronics housing ME.../BUS 5 and ME.../BUS 10 with double-level upper part

# Electronic housing - ME 22,5 UT/FE BUS/10 BK - 2854254

Dimensioned drawing

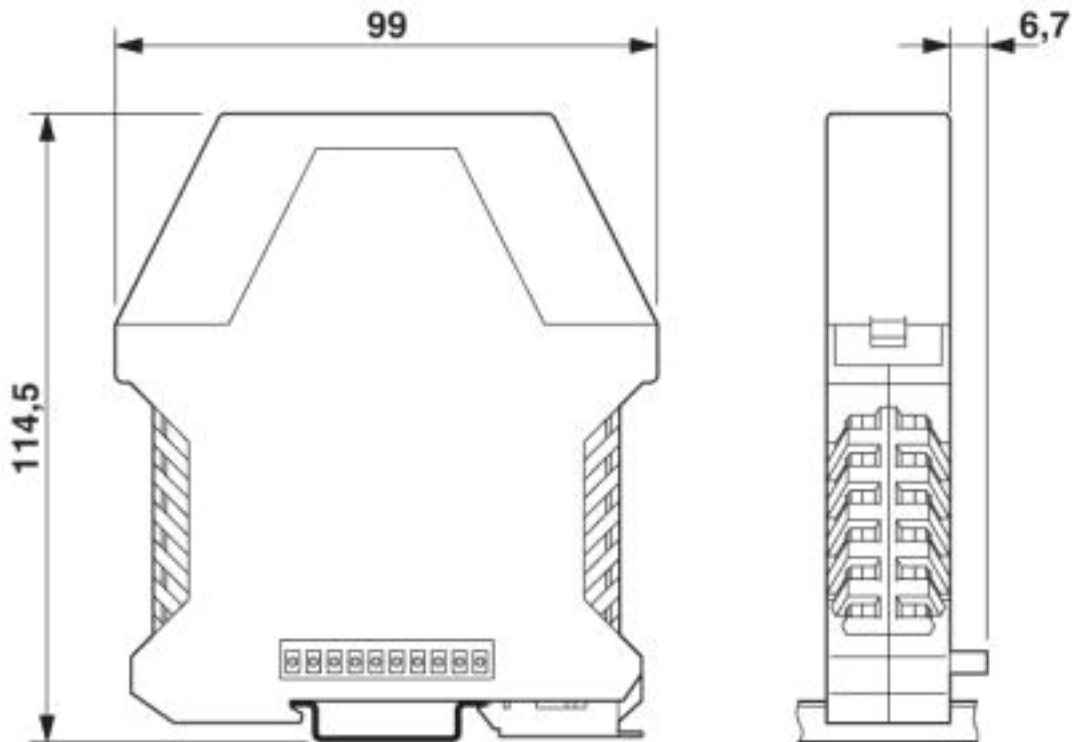

Dimensions of the electronics housing ME.../BUS 5 and ME.../BUS 10 with triple-level upper part

# Electronic housing - ME 22,5 UT/FE BUS/10 BK - 2854254

Dimensioned drawing

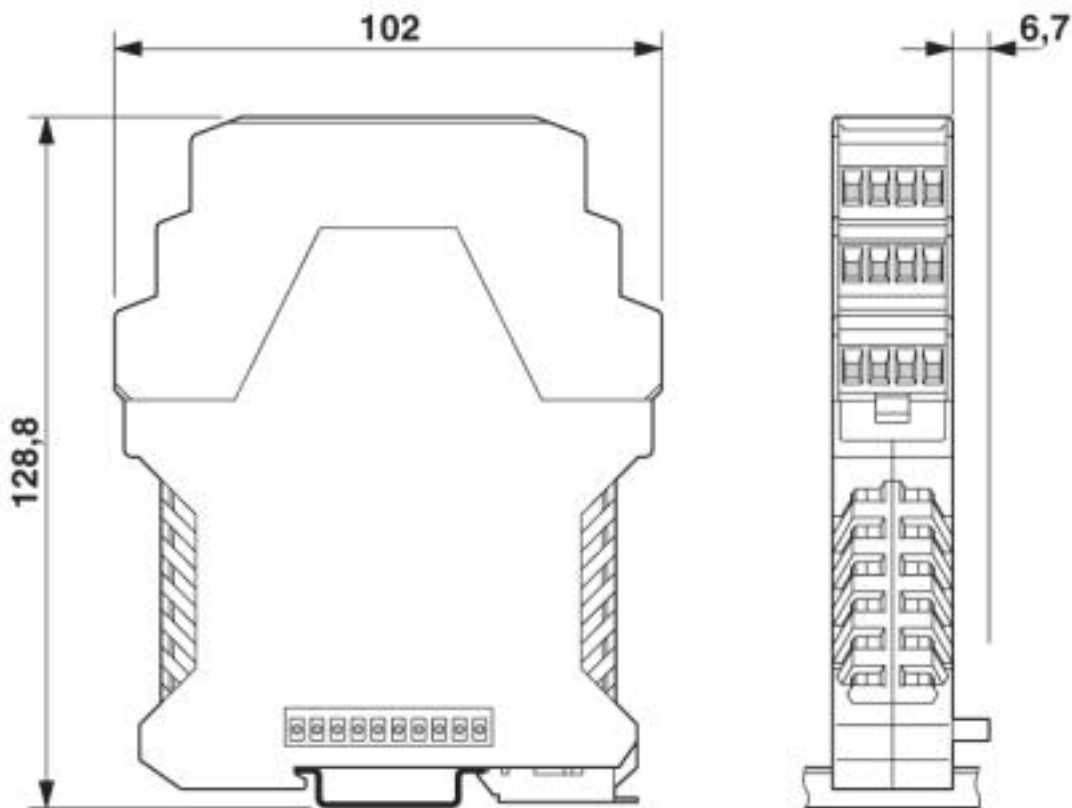

Dimensions of the electronics housing ME.../BUS 5 and ME.../BUS 10 with triple-level upper part

# Electronic housing - ME 22,5 UT/FE BUS/10 BK - 2854254

Dimensioned drawing

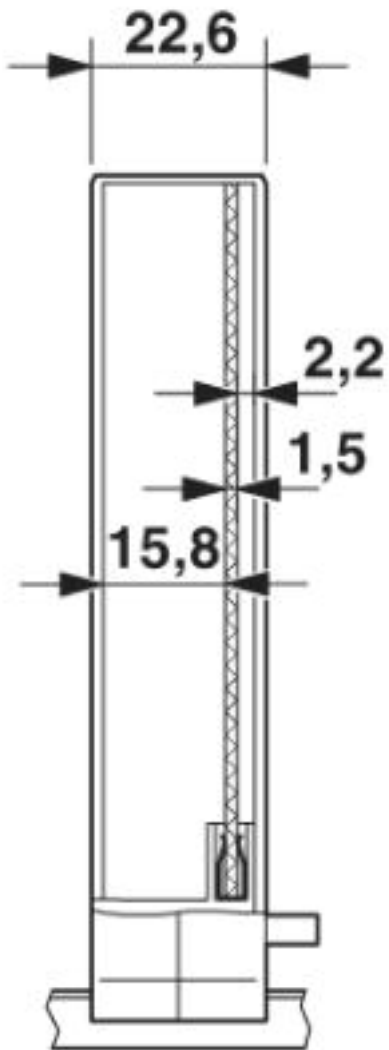

Internal housing dimensions, electronics housing ME 22.5 BUS...

# Electronic housing - ME 22,5 UT/FE BUS/10 BK - 2854254

Schematic diagram

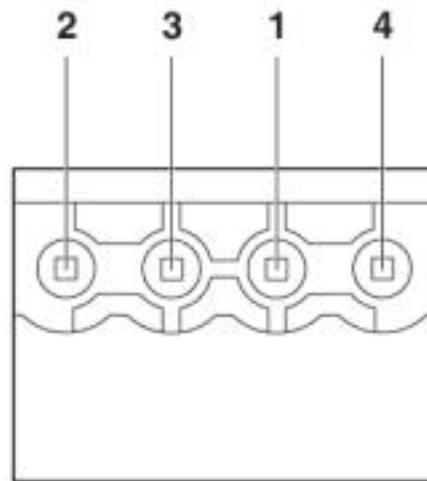
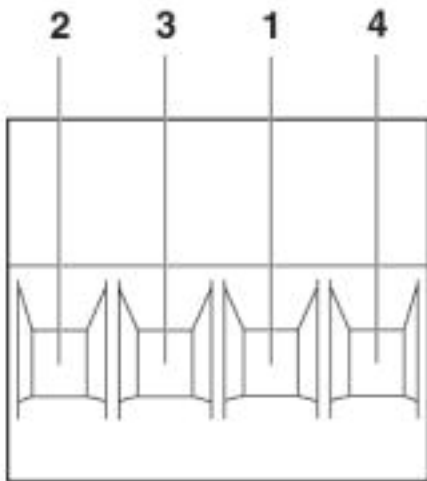

Pin assignment left

Schematic diagram

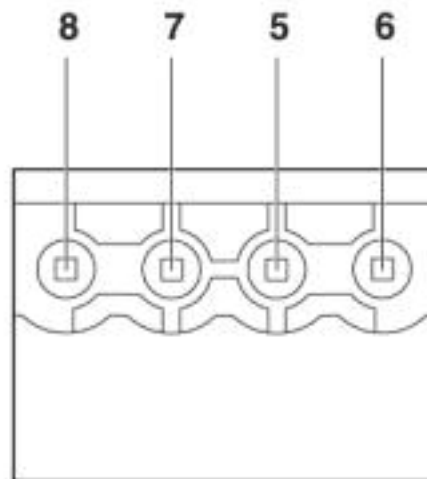
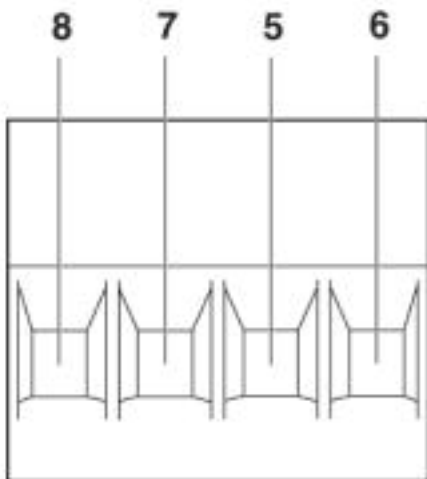

Pin assignment right