

Surface mounted ceramic multilayer capacitors

Class 1, NP0 series

FEATURES

- Six standard sizes
- High capacitance per unit volume
- Supplied in tape on reel or in bulk case (case sizes 0603 and 0805 only); loose in bag available on request
- For high frequency applications
- NiSn terminations (AgPd on request).

APPLICATIONS

- Consumer electronics
- Telecommunications
- Automotive
- Data processing.

DESCRIPTION

The capacitor consists of a rectangular block of ceramic dielectric in which a number of interleaved precious metal electrodes are contained. This structure gives rise to a high capacitance per unit volume.

The inner electrodes are connected to the two terminations, either by silver palladium (AgPd) alloy in the ratio 65 : 35, or silver dipped with a barrier layer of plated nickel and finally covered with a layer of plated tin (NiSn). A cross section of the structure is shown in Fig.1.

QUICK REFERENCE DATA

DESCRIPTION	VALUE
Rated voltage U_R (DC)	63 V, 100 V, 200 V and 500 V (IEC)
Capacitance range; note 1: general purpose; 63 V general purpose; 100 V narrow tolerance; 63 V high voltage; 200 V high voltage; 500 V	0.47 pF to 10000 pF (E12 series) 0.47 pF to 4700 pF (E12 series) 0.47 pF to 3300 pF (E12 series) 10 pF to 1500 pF (E12 series) 10 pF to 560 pF (E12 series)
Tolerance on capacitance: C ≥ 10 pF C < 10 pF	±10%, ±5%, ±2% and ±1% ±0.5 pF, ±0.25 pF and ±0.1 pF
Sectional specifications	IEC 384-10, second edition 1989-04; also based on CECC 32 100
Detailed specification	based on CECC 32 101-801
Climatic category (IEC 68)	55/125/56

Note

1. Other values below 10 pF and non E12 series are available on request.

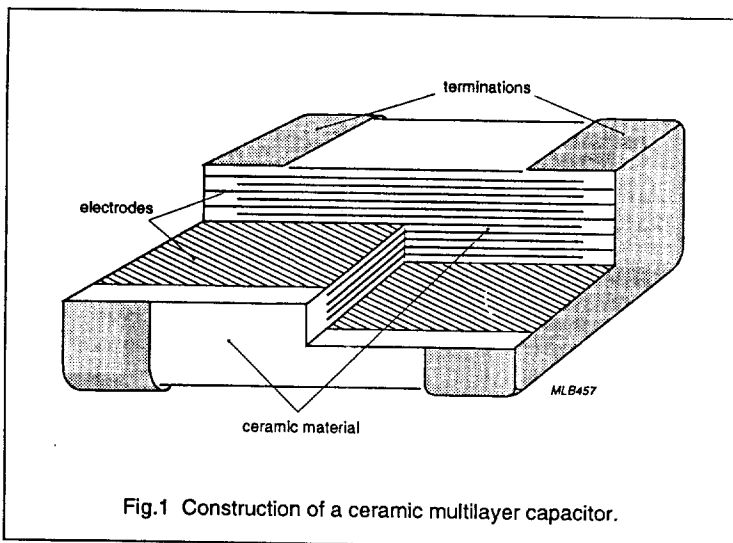
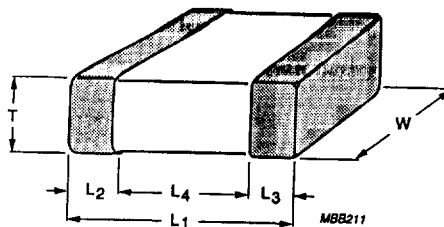

Fig.1 Construction of a ceramic multilayer capacitor.

Surface mounted ceramic
multilayer capacitors

Class 1, NP0 series

MECHANICAL DATA



For dimensions see Table 1

Fig.2 Component outline.

Physical dimensions

Table 1 Capacitor dimensions.

CASE SIZE	L ₁ (mm)	W (mm)	T		L ₂ and L ₃		L ₄ MIN. (mm)
			MIN. (mm)	MAX. (mm)	MIN. (mm)	MAX. (mm)	
0603	1.6 ±0.1	0.8 ±0.1	0.7	0.9	0.25	0.65	0.4
0805	2.0 ±0.1	1.25 ±0.1	0.51	1.35	0.25	0.75	0.55
1206	3.2 ±0.15	1.6 ±0.15	0.51	1.75	0.25	0.75	1.4
1210	3.2 ±0.2	2.5 ±0.2	0.51	1.8	0.25	0.75	1.4
1812	4.5 ±0.2	3.2 ±0.2	0.51	1.8	0.25	0.75	2.2
2220	5.7 ±0.2	5.0 ±0.2	0.51	1.8	0.25	0.75	2.9

Surface mounted ceramic multilayer capacitors

Class 1, NP0 series

SELECTION CHART FOR 63 VOLT GENERAL PURPOSE SERIES

MGA352 - 2

C (pF)	LAST THREE DIGITS OF 12 NC	8 mm TAPE WIDTH				12 mm TAPE WIDTH	
		0603	0805	1206	1210	1812	2220
		NiSn	NiSn	NiSn	NiSn	NiSn	AgPd
0.47	477	4	1	1			
0.56	567	4	1	1			
0.68	687	4	1	1			
0.82	827	4	1	1			
1.0	108	4	1	1			
1.2	128	4	1	1			
1.5	158	4	1	1			
1.8	188	4	1	1			
2.2	228	4	1	1			
2.7	278	4	1	1			
3.3	338	4	1	1			
3.9	398	4	1	1			
4.7	478	4	1	1			
5.6	568	4	1	1			
6.8	688	4	1	1			
8.2	828	4	1	1			
10	109	4	1	1			
12	129	4	1	1			
15	159	4	1	1			
18	189	4	1	1			
22	229	4	1	1			
27	279	4	1	1			
33	339	4	1	1			
39	399	4	1	1			
47	479	4	1	1	3		
56	569	4	1	1	3		
68	689	4	1	1	3		
82	829	4	1	1	3		
100	101	4	1	1	3		
120	121	4	1	1	3		
150	151	4	1	1	3		
180	181		1	1	3		
220	221		1	1	3		
270	271		1	1	3		
330	331		1	1	3		
390	391		2	1	3	5	
470	471		2	1	3	3	3
560	561		2	1	3	3	3
680	681		2	1	3	3	3
820	821		2	1	3	3	3
1000	102		2	1	3	3	3
1200	122		2	1	3	3	3
1500	152		2	1	3	3	3
1800	182		5	3	3	3	3
2200	222		5	3	3	3	3
2700	272		5	3	3	3	3
3300	332		5	3	3	3	3
3900	392		5	3	3	3	3
4700	472			7	3	3	3
5600	562				3	3	3
6800	682						3
8200	822						3
10000	103						3

THICKNESS CLASSIFICATION (mm)	8 mm TAPE WIDTH AMOUNT PER REEL		12 mm TAPE WIDTH AMOUNT PER REEL		AMOUNT PER BULK CASE	
	Ø 180 mm	Ø 286 mm	Ø 180 mm		0603	0805
			1812	1220		
1 = 0.51 to 0.7	4000	10000	-	-	-	10000
2 = 0.8 to 1.0	4000	10000	-	-	-	8000
3 = 0.51 to 1.0	4000	10000	2000	1500	-	-
4 = 0.8 to 1.0	4000	10000	-	-	15000	-
5 = 0.9 to 1.3	3000	8000	-	-	-	-
6 = 1.25 to 1.7	3000	8000	-	-	-	5000
7 = 1.2 to 1.75	2500	7000	-	-	-	-

Fig.3 Selection chart for 63 volt general purpose, class 1, NP0 series, with NiSn and AgPd terminations.

Surface mounted ceramic
multilayer capacitors

Class 1, NP0 series

ORDERING INFORMATION FOR 63 VOLT GENERAL PURPOSE SERIES

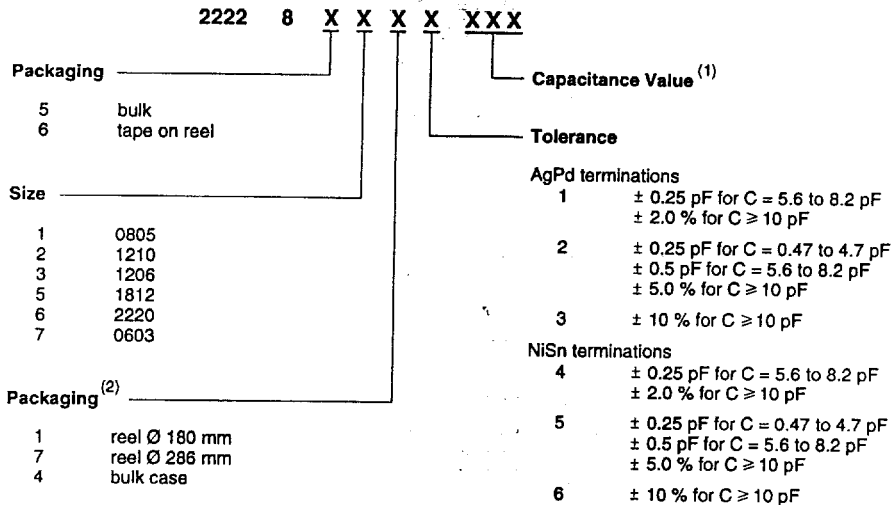

MLB018

For details of the 15-digit code refer to Section "General; Fig.6".

(1) Refer to selection chart (see Fig.3).

(2) Amount on reel depends on thickness classification (see Fig.3).

Fig.4 Composition of the 12NC for 63 volt general purpose, class 1, NP0 series.

Surface mounted ceramic
multilayer capacitors

Class 1, NP0 series

SELECTION CHART FOR 63 VOLT NARROW TOLERANCE SERIES

MGA450 - 2

C (pF)	LAST THREE DIGITS OF 12NC	8 mm TAPE WIDTH		
		0603	0805	1206
		NiSn	NiSn	NiSn
0.47	477	4	1	1
0.56	567	4	1	1
0.68	687	4	1	1
0.82	827	4	1	1
1.0	108	4	1	1
1.2	128	4	1	1
1.5	158	4	1	1
1.8	188	4	1	1
2.2	228	4	1	1
2.7	278	4	1	1
3.3	338	4	1	1
3.9	398	4	1	1
4.7	478	4	1	1
5.6	568	4	1	1
6.8	688	4	1	1
8.2	828	4	1	1
10	109	4	1	1
12	129	4	1	1
15	159	4	1	1
18	189	4	1	1
22	229	4	1	1
27	279	4	1	1
33	339	4	1	1
39	399	4	1	1
47	479	4	1	1
56	569	4	1	1
68	689	4	1	1
82	829	4	1	1
100	101	4	1	1
120	121	4	1	1
150	151	4	1	1
180	181		1	1
220	221		1	1
270	271		1	1
330	331		1	1
390	391		2	1
470	471		2	1
560	561		2	1
680	681		6	1
820	821		6	1
1000	102		6	1
1200	122			2
1500	152			2
1800	182			5
2200	222			5
2700	272			5
3300	332			5

THICKNESS CLASSIFICATION (mm)	8 mm TAPE WIDTH AMOUNT PER REEL		AMOUNT PER BULK CASE	
	Ø 180 mm	Ø 286 mm	0603	0805
1 = 0.51 to 0.7	4000	10000	-	10000
2 = 0.8 to 1.0	4000	10000	-	8000
4 = 0.8 ± 0.1	4000	10000	15000	-
5 = 0.9 to 1.3	3000	8000	-	-
6 = 1.25 ± 0.1	3000	8000	-	5000

Fig.5 Selection chart for 63 volt narrow tolerance, class 1, NP0 series, with NiSn terminations.

Surface mounted ceramic
multilayer capacitors

Class 1, NP0 series

ORDERING INFORMATION FOR 63 VOLT NARROW TOLERANCE SERIES

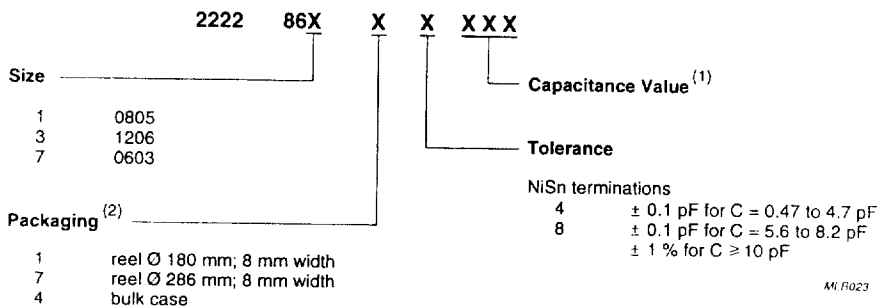

For details of the 15-digit code refer to Section "General; Fig.6".

(1) Refer to selection chart (see Fig.5).

(2) Amount on reel depends on thickness classification (see Fig.5).

Fig.6 Composition of the 12NC for 63 volt narrow tolerance, class 1, NP0 series.

Surface mounted ceramic multilayer capacitors

Class 1, NP0 series

ELECTRICAL CHARACTERISTICS

Class 1 capacitors; NP0 dielectric; NiSn terminations

Unless otherwise stated all electrical values apply at an ambient temperature of 20 ± 1 °C, an atmospheric pressure of 86 to 106 kPa, and a relative humidity of 63 to 67%.

DESCRIPTION	VALUE
Capacitance range (E12 series); note 1: general purpose narrow tolerance high voltage	0.47 pF to 10000 pF 0.47 pF to 3300 pF 10 pF to 1500 pF
Tolerance on capacitance after 1000 hours: $C \geq 10$ pF $5 \text{ pF} \leq C < 10$ pF $C < 5$ pF	$\pm 10\%$, $\pm 5\%$, $\pm 2\%$, and $\pm 1\%$ ± 0.5 pF and ± 0.1 pF ± 0.25 pF
Tan δ ; note 1: $C < 10$ pF $C \geq 10$ pF	$\leq 10 \left(\frac{3}{C} + 0.7 \right) \times 10^{-4}$; max. 30×10^{-4} $\leq 10 \times 10^{-4}$
Insulation resistance after 1 minute at U_R (DC)	$R_{ins} > 100 \text{ G}\Omega$
Temperature coefficient: $C < 10$ pF $C \geq 10$ pF	$(0 \pm 150) \times 10^{-6}/\text{K}$; note 2 $(0 \pm 30) \times 10^{-6}/\text{K}$; note 2

Notes

1. Measured at 1 V, 1 MHz for $C \leq 1000$ pF and 1 V, 1 kHz for $C > 1000$ pF, using a four gauge method.
2. For size 0603 all capacitance values from 0.47 pF to 150 pF have a temperature coefficient of $(0 \pm 30) \times 10^{-6}/\text{K}$.

Surface mounted ceramic multilayer capacitors

Class 1, NP0 series

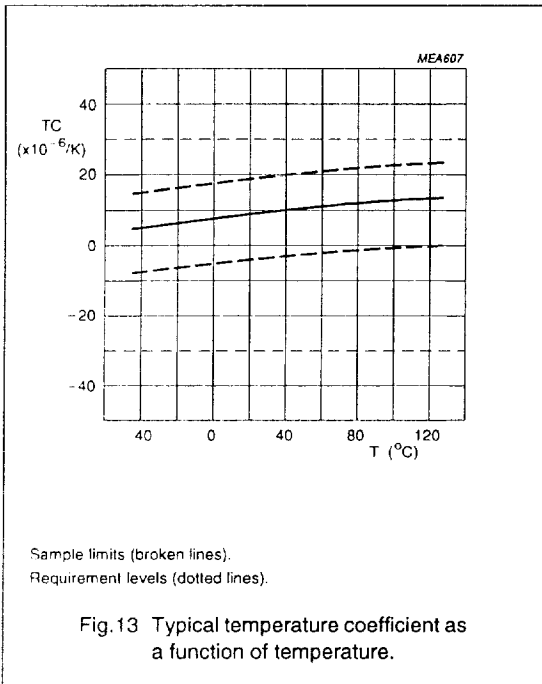

Fig.13 Typical temperature coefficient as a function of temperature.

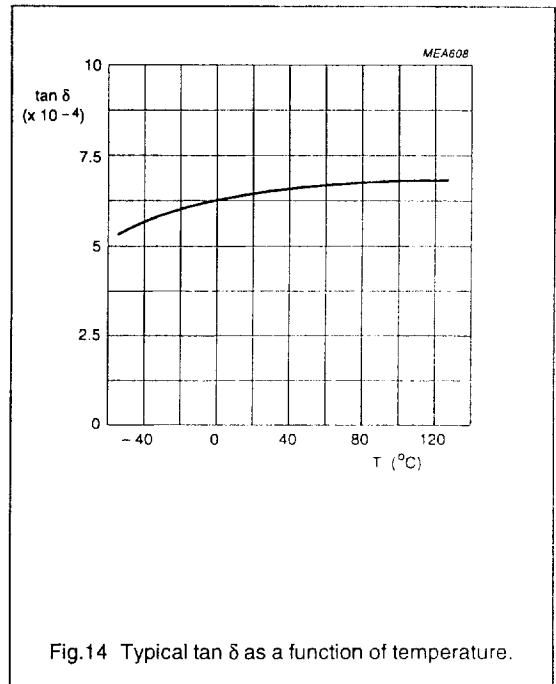

Fig.14 Typical $\tan \delta$ as a function of temperature.

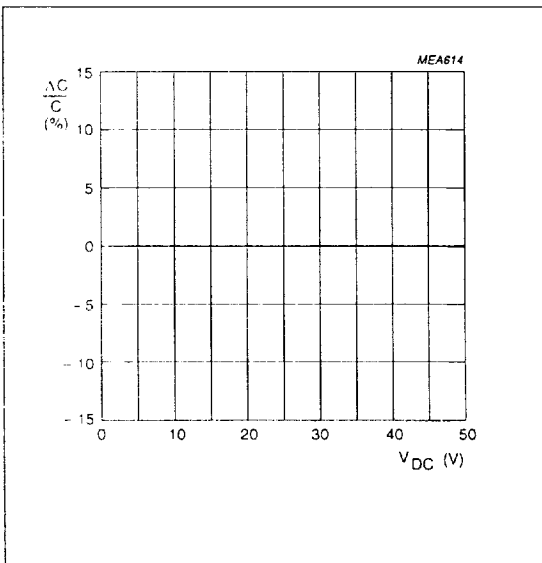

Fig.15 Typical capacitance change with respect to the capacitance at 1 V as a function of DC voltage.

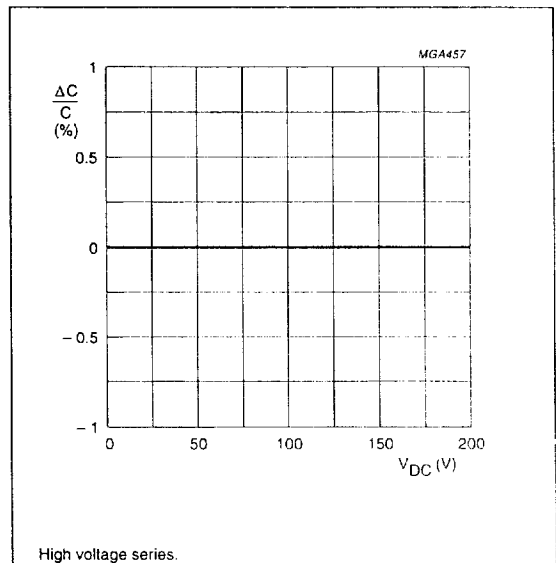
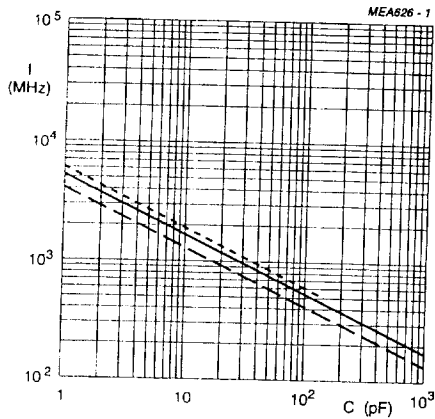

Fig.16 Typical capacitance change with respect to the capacitance at 1 V as a function of DC voltage.

Surface mounted ceramic multilayer capacitors

Class 1, NP0 series



$L = 0.6$ nH (dotted line).
 $L = 1$ nH (solid line).
 $L = 1.5$ nH (broken line).

Fig.17 Series resonance frequency as a function of capacitance.

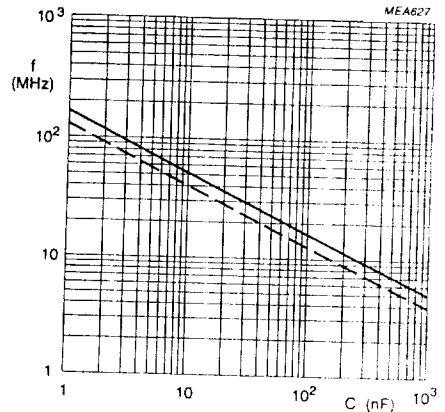

$L = 1$ nH (solid line).
 $L = 1.5$ nH (broken line).

Fig.18 Series resonance frequency as a function of capacitance.

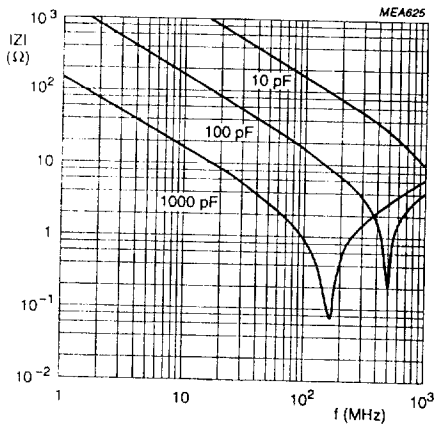

Case sizes 0603 to 1210.

Fig.19 Typical impedance ($|Z|$) as a function of frequency.

Surface mounted ceramic multilayer capacitors

Class 1, NP0 series

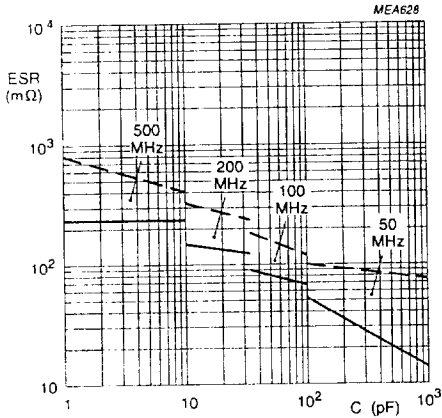

Case sizes **0603** and **0805**
 Typical values (solid lines).
 Maximum values (broken lines).
 Measuring equipment HP4191A.

Fig.20 Equivalent series resistance (ESR) as a function of capacitance.

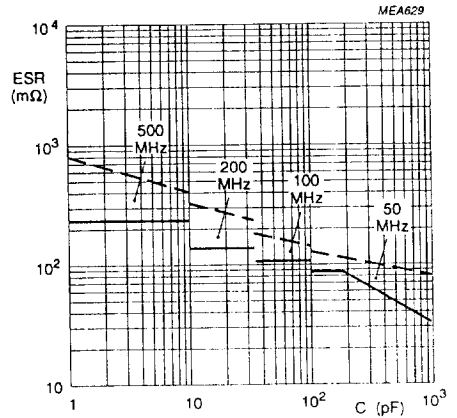

Case size **1206**.
 Typical values (solid lines).
 Maximum values (broken lines).
 Measuring equipment HP4191A.
 For $C > 1$ nF, maximum value of ESR = 80 mΩ measured at 50 MHz.

Fig.21 Equivalent series resistance (ESR) as a function of capacitance.

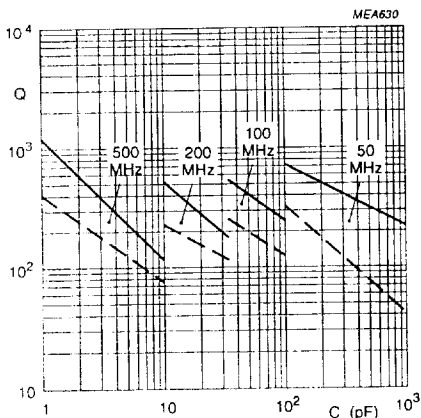

Case sizes **0603** and **0805**
 Typical values (solid lines).
 Minimum values (broken lines).
 Measuring equipment HP4191A.

Fig.22 Quality factor (Q) as a function of the capacitance.

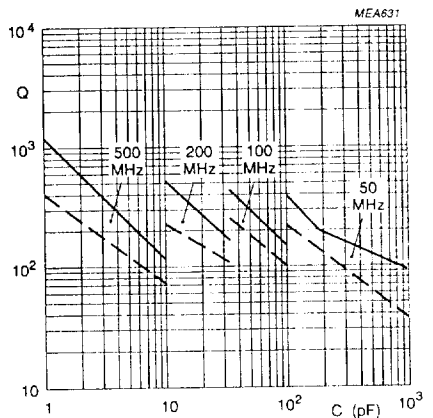

Case size **1206**.
 Typical values (solid lines).
 Minimum values (broken lines).
 Measuring equipment HP4191A.
 For $C > 1$ nF, $Q_{min} = 35$ measured at 50 MHz.

Fig.23 Quality factor (Q) as a function of the capacitance.

Surface mounted ceramic multilayer capacitors

Class 1, NP0 series

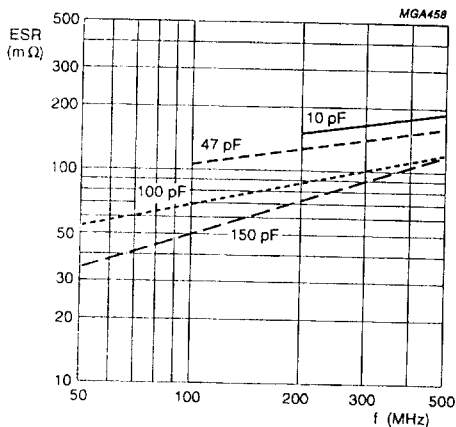

Case size 0805.
High voltage series.

Fig. 24 Typical equivalent series resistance as a function of frequency.

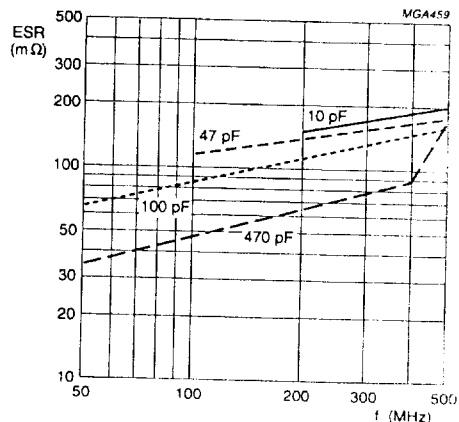

Case size 1206.
High voltage series.

Fig. 25 Typical equivalent series resistance as a function of frequency.

Surface mounted ceramic multilayer capacitors

Class 1, NP0 series

HIGH FREQUENCY BEHAVIOUR OF CERAMIC MULTILAYER CAPACITORS

Ceramic multilayer capacitors (CMC) are suitable for use at high frequencies. At frequencies below the series resonance frequency, the CMC can be represented by an equivalent circuit as shown in Fig.26

In general, the quantities C, ESR and L are frequency dependent. For most applications, C and L can be regarded as frequency independent below 1 GHz

The equivalent series self-inductance L is:

- Independent of the dielectric material
- Dependent on the size of the capacitor, it increases with increasing length and decreases with increasing width or thickness of the product
- The value of L is approximately:
 - 0.6 nH for case size 603
 - 1 nH for case sizes 0805, 1206 and 1210
 - 1.5 nH for case sizes 1812 and 2220.

These figures are accurate to within 20%.

Because of the inductance L, associated with the CMC, there will be a frequency at which the inductive reactance will be equal to the reactance of the capacitor.

This is known as the series resonance frequency (SRF) and is given by:

$$SRF = \frac{1}{2\pi\sqrt{LC}}$$

At the SRF, the CMC will appear as a small resistor. The transmission loss through the CMC at this series resonance frequency will be low.

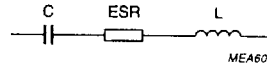

C = capacitance.

ESR = equivalent series resistance which is determined by the energy dissipation mechanisms (in the dielectric material as well as in the electrodes).

L = equivalent series self-inductance.

Fig.26 Equivalent series representation of a CMC.

Using the values of C, L = 1 nH and the ESR at a specific frequency (f), two often used quantities can be derived.

The impedance (Z) is given by: $Z = \frac{1 - (2\pi f)^2 LC}{2j\pi f C} + ESR$

The quality factor (Q) is given by: $Q = \frac{|1 - (2\pi f)^2 LC|}{2\pi f ESR C}$

Surface mounted ceramic multilayer capacitors

Class 2, X7R series

FEATURES

- Six standard sizes
- High capacitance per unit volume
- Supplied in tape on reel or in bulk case; loose in bag available on request
- NiSn terminations (AgPd on request; not for case size 0603).

APPLICATIONS

- Consumer electronics
- Telecommunications
- Automotive
- Data processing.

DESCRIPTION

The capacitor consists of a rectangular block of ceramic dielectric in which a number of interleaved precious metal electrodes are contained. This structure gives rise to a high capacitance per unit volume.

The inner electrodes are connected to the two terminations, either by silver palladium (AgPd) alloy in the ratio 65 : 35, or silver dipped with a barrier layer of plated nickel and finally covered with a layer of plated tin (NiSn). A cross section of the structure is shown in Fig.1.

QUICK REFERENCE DATA

DESCRIPTION	VALUE
Rated voltage U_R (DC)	25 V, 63 V, 100 V, 200 V and 500 V (IEC)
Capacitance range; note 1:	
25 V	10 nF to 470 nF (E12 series)
63 V	100 pF to 1 μ F (E12 series)
100 V	180 pF to 220 nF (E12 series)
200 V	180 pF to 100 nF (E12 series)
500 V	470 pF to 15 nF (E12 series)
Tolerance on capacitance	$\pm 20\%$, $\pm 10\%$ and $\pm 5\%$
Test voltage (DC) for 1 minute:	
25 V, 63 V and 100 V	$2.5 \times U_R$
200 V and 500 V	$3 \times U_R$
Sectional specifications	IEC 384-10, second edition 1989-04; also based on CECC 32 100
Detailed specification	based on CECC 32 101-801
Climatic category (IEC 68)	55/125/56

Note

1. Non E12 values are available on request.

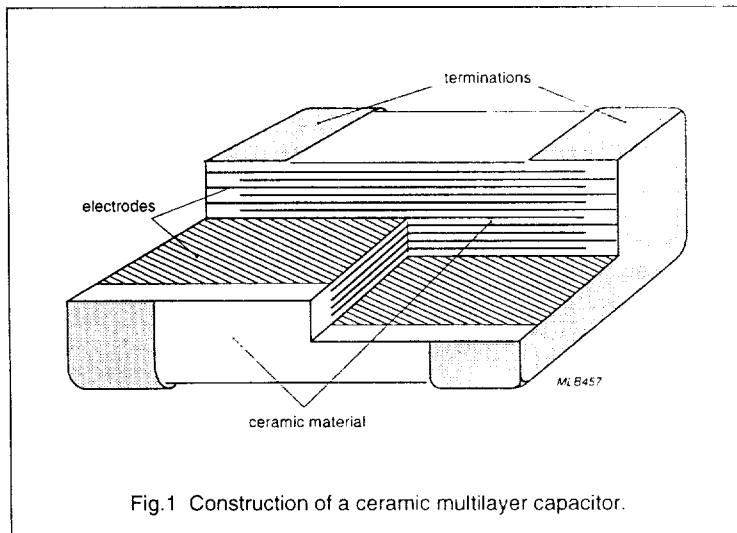
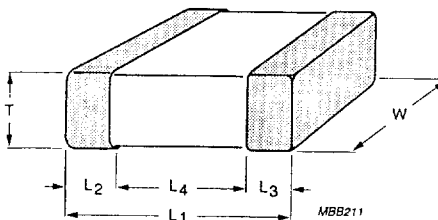

Fig.1 Construction of a ceramic multilayer capacitor.

Surface mounted ceramic multilayer capacitors

Class 2, X7R series

MECHANICAL DATA



For dimensions see Table 1.

Fig.2 Component outline.

Physical dimensions

Table 1 Capacitor dimensions.

CASE SIZE	L ₁ (mm)	W (mm)	T		L ₂ and L ₃		L ₄ MIN. (mm)
			MIN. (mm)	MAX. (mm)	MIN. (mm)	MAX. (mm)	
0603	1.6 ±0.1	0.8 ±0.1	0.7	0.9	0.25	0.65	0.4
0805	2.0 ±0.1	1.25 ±0.1	0.51	1.35	0.25	0.75	0.55
1206	3.2 ±0.15	1.6 ±0.15	0.51	1.75	0.25	0.75	1.4
1210	3.2 ±0.2	2.5 ±0.2	0.51	1.8	0.25	0.75	1.4
1812	4.5 ±0.2	3.2 ±0.2	0.51	1.8	0.25	0.75	2.2
2220	5.7 ±0.2	5.0 ±0.2	0.51	1.8	0.25	0.75	2.9

Surface mounted ceramic
multilayer capacitors

Class 2, X7R series

SELECTION CHART FOR 63 VOLT SERIES

MGA353 - 3

C (pF)	LAST TWO DIGITS OF 12 NC	8 mm TAPE WIDTH				12 mm TAPE WIDTH	
		0603	0805	1206	1210	1812	2220
		NiSn	NiSn	NiSn	NiSn	NiSn	AgPd
100	01	4					
120	02	4					
150	03	4					
180	04	4	1				
220	05	4	1	2a			
270	06	4	1	2a			
330	07	4	1	2a			
390	08	4	1	2a			
470	09	4	1	2a			
560	11	4	1	2a			
680	12	4	1	2a			
820	13	4	1	2a			
1000	14	4	1	2a			
1200	15	4	1	2a			
1500	16	4	1	2a			
1800	17	4	1	2a			
2200	18	4	1	2a	3		
2700	19	4	1	2a	3		
3300	21	4	1	2a	5		
3900	22	4	1	2a	3		
4700	23	4	1	2a	3	3	
5600	24	4	1	2a	3	3	
6800	25	4	1	2a	3	3	
8200	26	4	1	2a	3	3	
10000	27	4	1	2a	3	3	
12000	28		1	2a	3	3	3
15000	29		1	2a	3	3	5
18000	31		2	2a	3	3	3
22000	32		2	2a	3	3	3
27000	33		2	2a	3	3	3
33000	34		2	2a	3	3	3
39000	35			2a	3	3	3
47000	36			2a	3	3	3
56000	37			2a	3	3	3
68000	38			2a	3	3	3
82000	39			2a	3	3	3
100000	41			2a	3	3	3
120000	42				3	3	3
150000	43				3	3	3
180000	44				5	3	3
220000	45				5	3	3
270000	46					3	3
330000	47					5	3
390000	48					5	3
470000	49					7	3
560000	51						3
680000	52						3
820000	53						3
1000000	54						5

THICKNESS CLASSIFICATION (mm)	8 mm TAPE WIDTH AMOUNT PER REEL		12 mm TAPE WIDTH AMOUNT PER REEL	AMOUNT PER BULK CASE	
	Ø 180 mm	Ø 286 mm	Ø 180 mm	0603	0805
1 = 0.51 to 0.7	4000	10000	2000	-	10000
2 = 0.8 to 1.0	4000	10000	2000	-	8000
2a = 0.7 to 1.0	4000	10000	2000	-	-
3 = 0.51 to 1.0	4000	10000	2000	-	-
4 = 0.8 to 0.1	4000	10000	-	15000	-
5 = 0.9 to 1.3	3000	8000	1500	-	-
7 = 1.2 to 1.75	2000	7000	1200	-	-

Fig.5 Selection chart for 63 volt, class 2, X7R series with, NiSn and AgPd terminations.

Surface mounted ceramic
multilayer capacitors

Class 2, X7R series

ORDERING INFORMATION FOR 63 VOLT SERIES

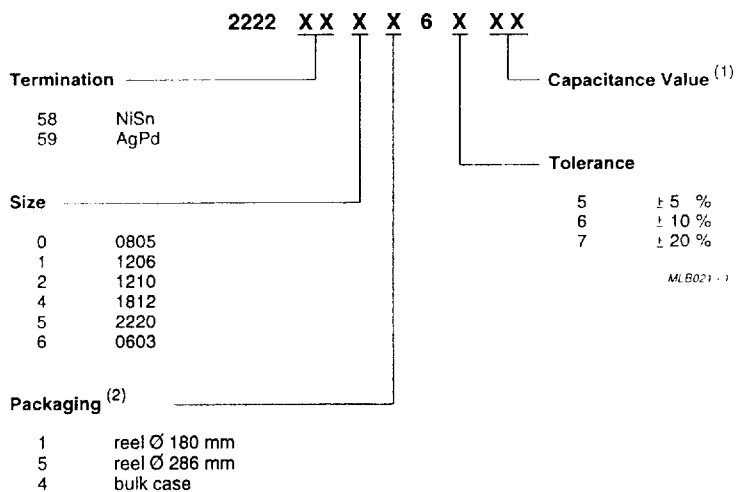

MLB021 - 1

For details of the 15-digit code refer to Section "General; Fig.6".

(1) Refer to selection chart (see Fig.5).

(2) Amount on reel depends on thickness classification (see Fig.5).

Fig.6 Composition of the 12NC for 63 volt, class 2, X7R series.

Surface mounted ceramic multilayer capacitors

Class 2, X7R series

ELECTRICAL CHARACTERISTICS

Class 2 capacitors; X7R dielectric; AgPd and NiSn terminations

Unless otherwise stated all electrical values apply at an ambient temperature of 20 ± 1 °C, an atmospheric pressure of 86 to 106 kPa, and a relative humidity of 63 to 67%.

DESCRIPTION	VALUE
Capacitance range (E12 series); note 1	10 nF to 1 μ F
Tolerance on capacitance after 1000 hours	$\pm 20\%$, $\pm 10\%$ and $\pm 5\%$; note 2
Tan δ ; note 1	$\leq 2.5\%$
Insulation resistance after 1 minute at U_R (DC): C \leq 10 nF C > 10 nF	$R_{ins} > 100$ G Ω $R_{ins} \times C > 1000$ s
Maximum capacitance change as a function of temperature (for typical values see Fig.13)	$\pm 15\%$
Ageing	typical 1% per time decade

Notes

1. Measured at 1 V, 1 kHz, using a four gauge method.
2. Tolerance of $\pm 1\%$ available on request.

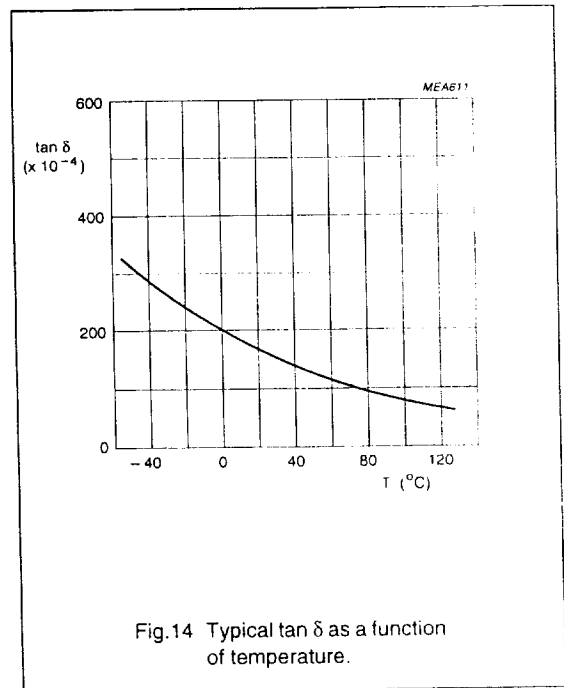
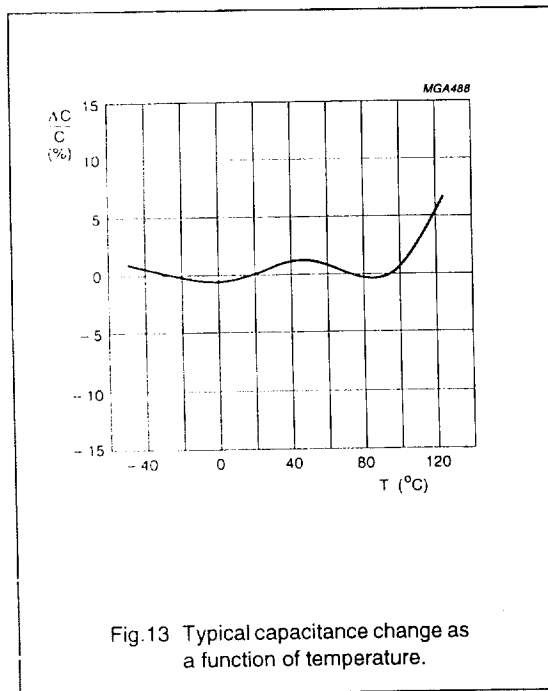

Surface mounted ceramic multilayer capacitors

Class 2, X7R series

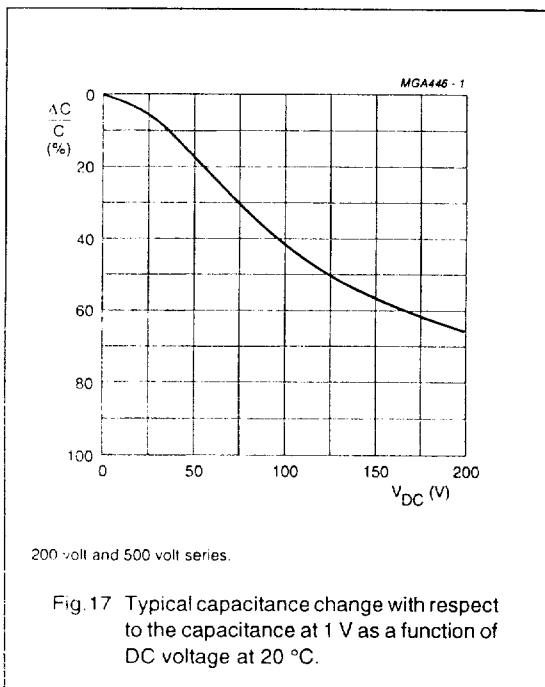
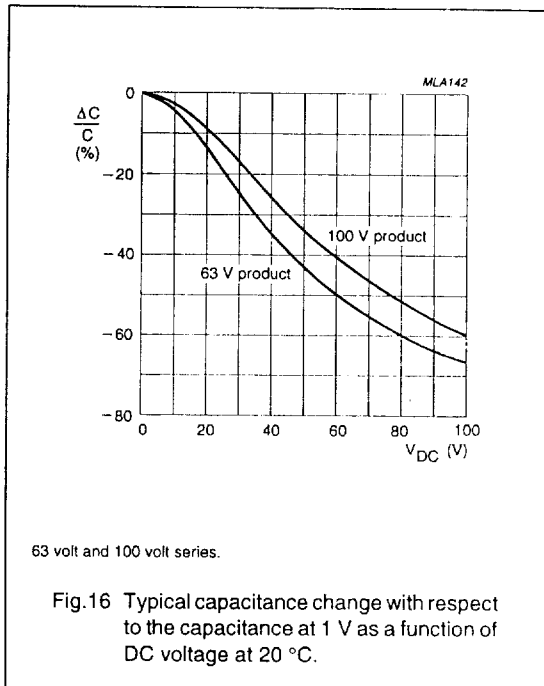
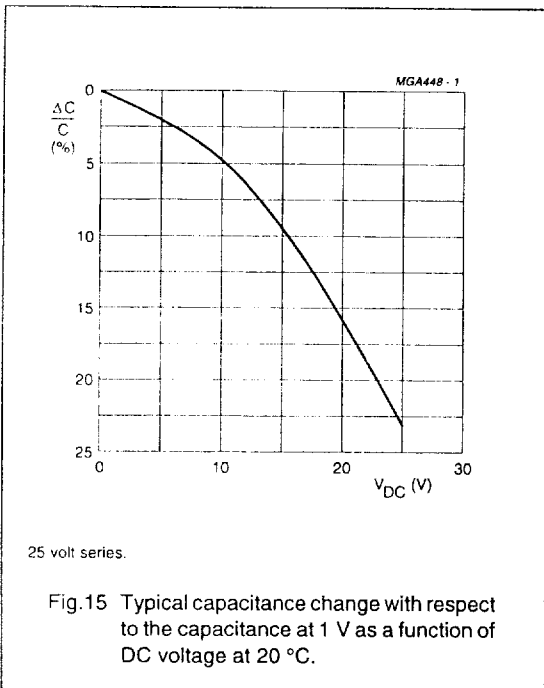

Standard-Chip-Kondensatoren Z5U (Y5U)/2F4



Eigenschaften

- Höchste Volumenkapazität
- Nichtlineare Kapazitätsänderung

Anwendungen

- Abblockung
- Kopplung
- Entkopplung
- Entstörung

Anschlüsse

- für Lottechnik:
Silber-Nickel-Zinn
- für Leitlebetechnik:
Silber-Nickel

Verpackung

- Gürtung: Blister und Karton,
Einzelheiten siehe Kapitel
„Gürtung und Verpackung“, Seite 105.
- Bulk Case für Baugrößen 0603, 0805
und 1206. Einzelheiten siehe Seite 107.

Beschriftung

Auf Anfrage

Grenzdaten

Klimakategorie
nach IEC 68-1: 30/85/56

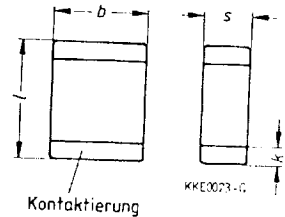

Maße (mm)

Baugröße	l	b	s	k ¹⁾
0402	1,0 ± 0,1	0,5 ± 0,05	0,5 ± 0,05	0,2
0603	1,6 ± 0,15	0,8 ± 0,1	0,8 ± 0,1	0,3
0805	2,0 ± 0,2	1,25 ± 0,15	1,3 max.	0,5
1206	3,2 ± 0,2	1,6 ± 0,15	1,3 max.	0,5
1210	3,2 ± 0,2	2,5 ± 0,2	1,3 max.	0,5
1812	4,5 ± 0,2	3,2 ± 0,2	1,3 max.	0,5
2220	5,7 ± 0,2	5,0 ± 0,2	1,3 max.	0,5

Für eingeschränkte Bauhöhe siehe Slim-Line-Kondensatoren, Seite 55.

Lieferbare Kapazitätstoleranz

$\Delta C_N / C_N = \pm 20\%$, Symbol: M

Nennspannungswerte

$V_N = 25 \text{ V}, 50 \text{ V}^{2)}$

1) Toleranzen entsprechen CECC 32 101-801

2) Auch für 63 V-Applikationen geeignet.

Bestellnummern Standard-Chip-Kondensatoren, Z5U(Y5U)/2F4, 25 V-, AgNiSn-Kontakte

Baugröße	0402	0603	0805	1206	
C_N	Bestellnummer ¹⁾				
	B37922-	B37932-	B37942-	B37873-	
2,2 nF	-K0222-M60 ▲				
3,3 nF	-K0332-M60 ▲				
4,7 nF	-K0472-M60 ▲				
6,8 nF	-K0682-M60 ▲				
10 nF	-K0103-M60 ▲				
15 nF					
22 nF		-K0223-M60 ○			
33 nF		-K0333-M60 ○			
47 nF		-K0473-M60 ○	-K0473-M60 □		
68 nF		-K0683-M60 ○	-K0683-M60 □		
100 nF		-K0104-M60 ○	-K0104-M60 □		
150 nF			-K0154-M60 ○	-K0154-M62 ○	
220 nF			-K0224-M62 ◆	-K0224-M62 ○	
330 nF			-K0334-M62 ◆	-K0334-M62 ○	
470 nF				-K0474-M62 ◆	
680 nF				-K0684-M62 ◆	
1,0 μF				-K0105-M62 ◆	

Chipdicke: ▲: $0,5 \pm 0,05$ mm □: $0,6 \pm 0,1$ mm
 ○: $0,8 \pm 0,1$ mm ◆: $1,2 \pm 0,1$ mm

1) In den Tabellen ist die Bestellnummer für Chip-Kondensatoren, $V_N = 25$ V-
 – mit einer Kap.-Toleranz ± 20 %
 – in der jeweiligen Standardverpackung
 Blistergurt (Endung der Bestellnummer: 62) bzw. Kartongurt (Endung der Bestellnummer: 60) auf Rolle $\varnothing 180$ mm angegeben.
 Für andere Ausführungsarten siehe „Liefermöglichkeiten und Bestellnummer“, Seite 113.



Z5U
2F4

Bestellnummern Standard-Chip-Kondensatoren, Z5U(Y5U)/2F4, 50 V-, AgNiSn-Kontakte

Baugröße	0603	0805	1206	
C_N	Bestellnummer ¹⁾			
	B37932-	B37942-	B37873-	
10 nF	-K5103-M60 ○	-K5103-M60 □		
15 nF	-K5153-M60 ○	-K5153-M60 □		
22 nF	-K5223-M60 ○	-K5223-M60 □		
33 nF	-K5333-M60 ○	-K5333-M60 □		
47 nF	-K5473-M60 ○	-K5473-M60 □	-K5473-M62 ○	
68 nF		-K5683-M62 ○	-K5683-M62 ○	
100 nF		-K5104-M62 ○	-K5104-M62 ○	
150 nF		-K5154-M62 ◆	-K5154-M62 ○	
220 nF			-K5224-M62 ○	
330 nF			-K5334-M62 ◆	
470 nF			-K5474-M62 ◆	

Baugröße	1210	1812	2220	
C_N	Bestellnummer ¹⁾			
	B37951-	B37954-	B37957-	
220 nF	-K5224-M62 ○			
330 nF	-K5334-M62 ○			
470 nF	-K5474-M62 ○	-K5474-M62 ◆		
680 nF	-K5684-M62 ◆	-K5684-M62 ◆		
1 µF	-K5105-M62 ◆	-K5105-M62 ◆	-K5105-M62 ◆	
1,5 µF		-K5155-M62 ◆	-K5155-M62 ◆	
2,2 µF			-K5225-M62 ◆	
3,3 µF			-K5335-M62 ◆	
4,7 µF			-K5475-M62 ◆	

Chipdicke: □: 0,6 ± 0,1 mm

○: 0,8 ± 0,1 mm

◆: 1,2 ± 0,1 mm

1) In den Tabellen ist die Bestellnummer für Chip-Kondensatoren, $V_N = 50$ V-
- mit einer Kap.-Toleranz ± 20 %

- in der jeweiligen Standardverpackung

Blistergurt (Endung der Bestellnummer: 62) bzw. Kartongurt (Endung der Bestellnummer: 60) auf Rolle Ø 180 mm angegeben.
Für andere Ausführungsarten siehe „Liefermöglichkeiten und Bestellnummer“, Seite 113.

Kenndaten

Kapazitätsänderung $\Delta C/C_{25}$ in Abhängigkeit von der Temperatur T

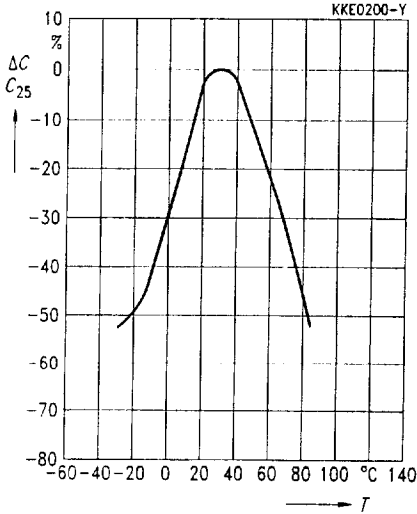

Kapazitätsänderung $\Delta C/C_0$ in Abhängigkeit von der überlagerten Gleichspannung V

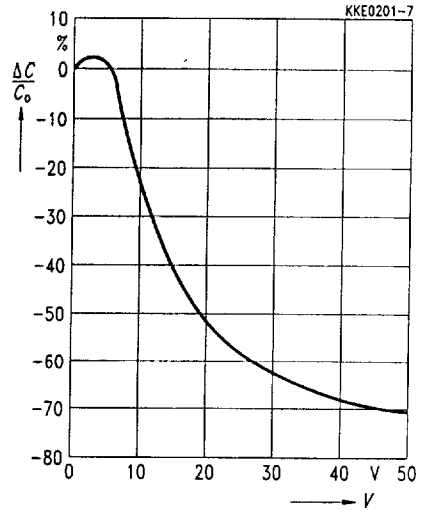

Scheinwiderstand $|Z_I|$ in Abhängigkeit von der Frequenz f

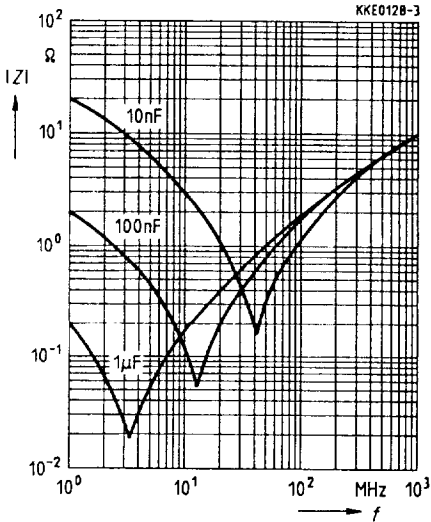

Verlustfaktor $\tan \delta$ in Abhängigkeit von der Temperatur T

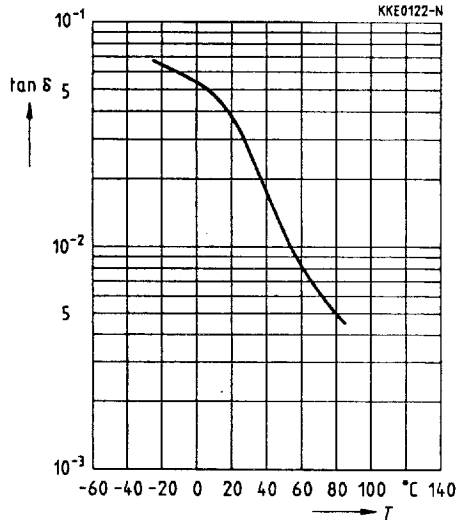

Z5U
2F4



Isolationswiderstand R_{is} in Abhängigkeit von der Temperatur T

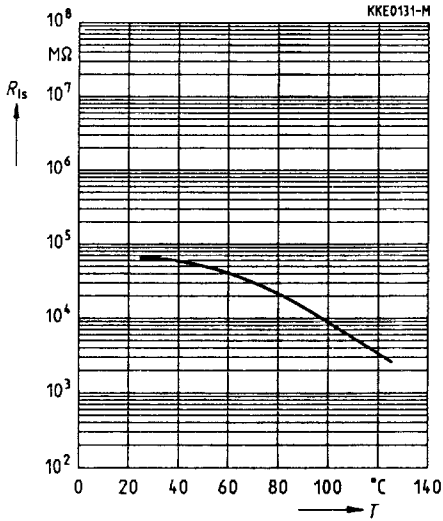

Kapazitätsänderung $\Delta C/C_1$ in Abhängigkeit von der Zeit t

