

DigiMicroscope Professional

reflecta[®]

**User's
Manuel**



Table of Contents

EN

1.	Precaution.....	3
2.	Preparation.....	6
	● Standard Accessories.....	6
	● Part Names & Functions.....	7
3.	key features.....	8
4.	Use the Microscope.....	9
	● Install Battery.....	9
	● Insert a MicroSD Card.....	10
	● Display Icons & Meanings.....	11
	● Turn on the Microscope.....	12
	● Turn off the Microscope.....	12
	● How to Capture.....	13
	● Download to Computer.....	20
	● Preview on Computer.....	20
	● Charge Battery.....	21
	● Connect to TV.....	22
5.	Menu Introductions.....	23
	● Set Resolution.....	23
	● Timer.....	24
	● Quality.....	25
	● Sharpness.....	26
	● Language.....	27
	● Power Save.....	27
	● Date Stamp.....	28
	● TV out.....	28
	● Date/Time.....	29
	● Format SD.....	29
	● System Reset.....	30
	● Version.....	30
6.	Specifications.....	31

7. Computer System Minimum Requirement.....	31
8. Troubleshooting.....	32

PortableCapture Pro Software Introductions.....33

1. Install Software.....	33
2. Start Microscope.....	34
3. Software Introductions.....	35
● Preview size.....	35
● Rotate Image.....	36
● Date/Time.....	36
● Language.....	37
● Full Screen.....	38
● Capture.....	39
● Edit Photos.....	40
● Edit Video.....	42
● Quit PortableCapture.....	43
4. Measurement.....	44
5. PortableCapture for Mac.....	50
Part I Install PortableCapture.....	51
Part II Use PortableCapture.....	51
● Preview.....	51
● Date/Time.....	52
● Photo Capture.....	53
● Video Capture.....	54
● Edit Photo/Video.....	55
● Help.....	56
● Quit.....	56

Welcome

Thank you for purchasing a Portable Stand Alone LCD Digital Microscope.

Please take a moment to read through this manual. Its contents will help you to get the best use of the smart microscope.

1. Precaution

Before using the LCD Digital Microscope, please ensure that you read and understand the safety precautions described below. Always ensure that the LCD Digital Microscope is operated correctly.

- Never operate LCD Digital Microscope where operation of such devices is restricted. Improper use creates the risk of serious accident.
- Do not try to open the case of LCD Digital Microscope or attempt to modify LCD Digital Microscope in any way. Maintenance and repairs should be performed only by authorized service providers.
- Keep LCD Digital Microscope away from water and other liquids. Do not use LCD Digital Microscope with wet hands. Never use LCD Digital Microscope in the rain or snow. Moisture creates the danger of fire and electric shock.

If you notice smoke or a strange odor coming from LCD Digital Microscope, turn the power off immediately.

Take LCD Digital Microscope to the nearest authorized service center for repair. Never attempt to repair LCD Digital Microscope on your own.

- LCD Digital Microscope may become slightly warm during use. This does not indicate malfunction.
- If the exterior of LCD Digital Microscope needs cleaning, wipe it with a soft, dry cloth.

FCC Notice

EN

- This equipment has been tested and found to comply with the limits for a Class B digital device, pursuant to Part 15 of the FCC Rules. These limits are designed to provide reasonable protection against harmful interference in a residential installation.

CAUTION

To comply with the limits for a Class B digital device, pursuant to Part 15 of the FCC Rules, this device, when needed, must only be connected to computer equipment certified to comply with the Class B limits.

2. Preparation

■ Standard accessories



LCD Digital
Microscope

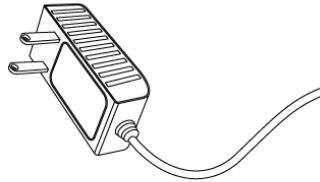

AC adaptor

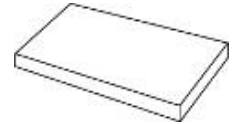

Lithium Battery



USB cable



TV cable

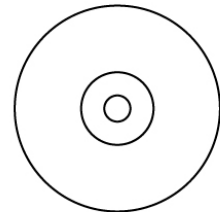

CD

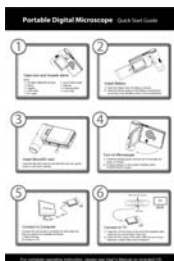

QSG

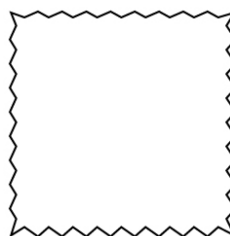

Cleaning fabric

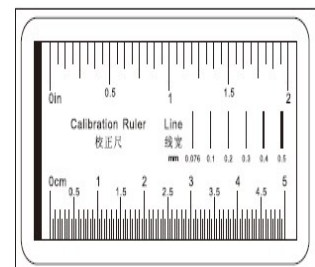

Calibration
chart

■ Parts Names & Functions

EN

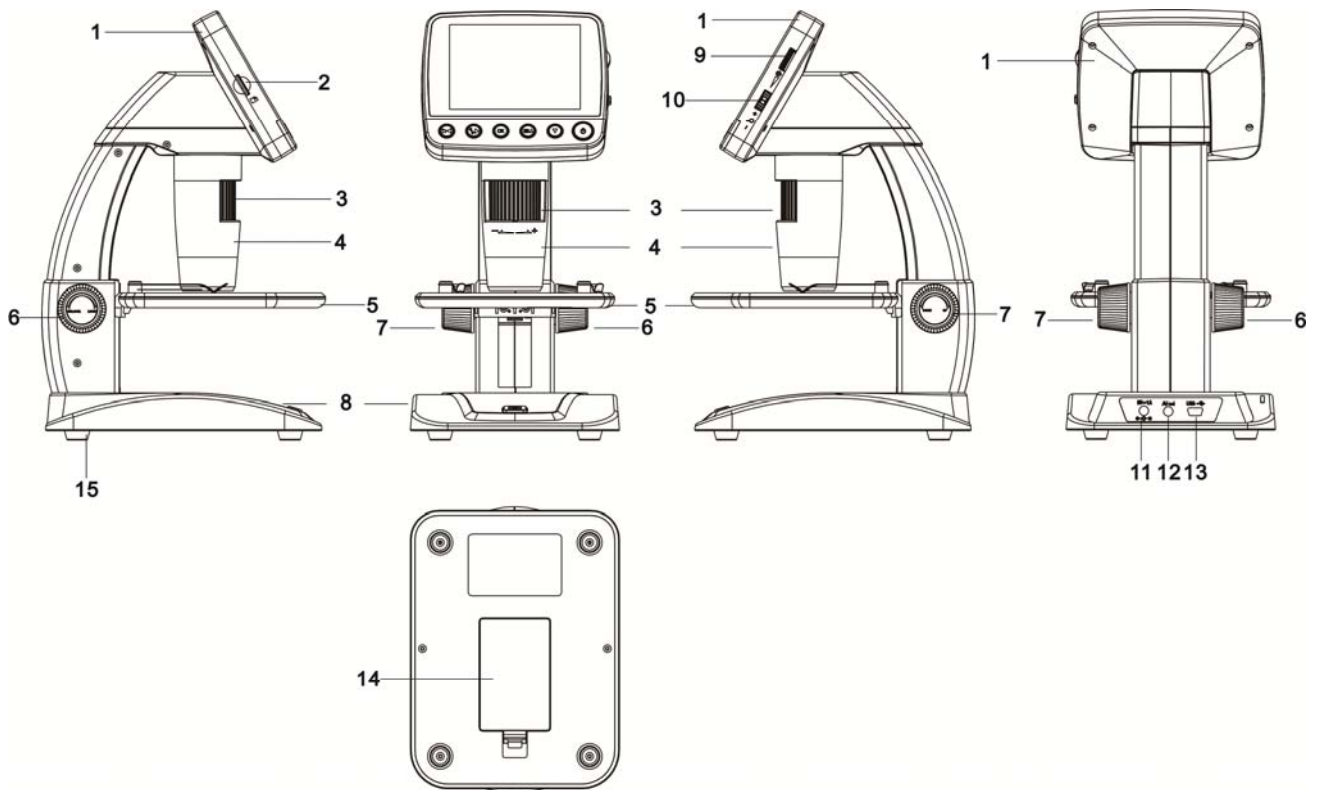

No.	Functions	No.	Functions
1	3.5" LCD display	9	LED brightness dimmer
2	MicroSD card slot	10	Zoom +/-
3	Wheel B	11	5v DC in
4	Microscope tube	12	TV out
5	Object stage	13	USB port
6	Wheel A	14	Battery compartment
7	Wheel C	15	Battery charging indicator
8	Capture button		

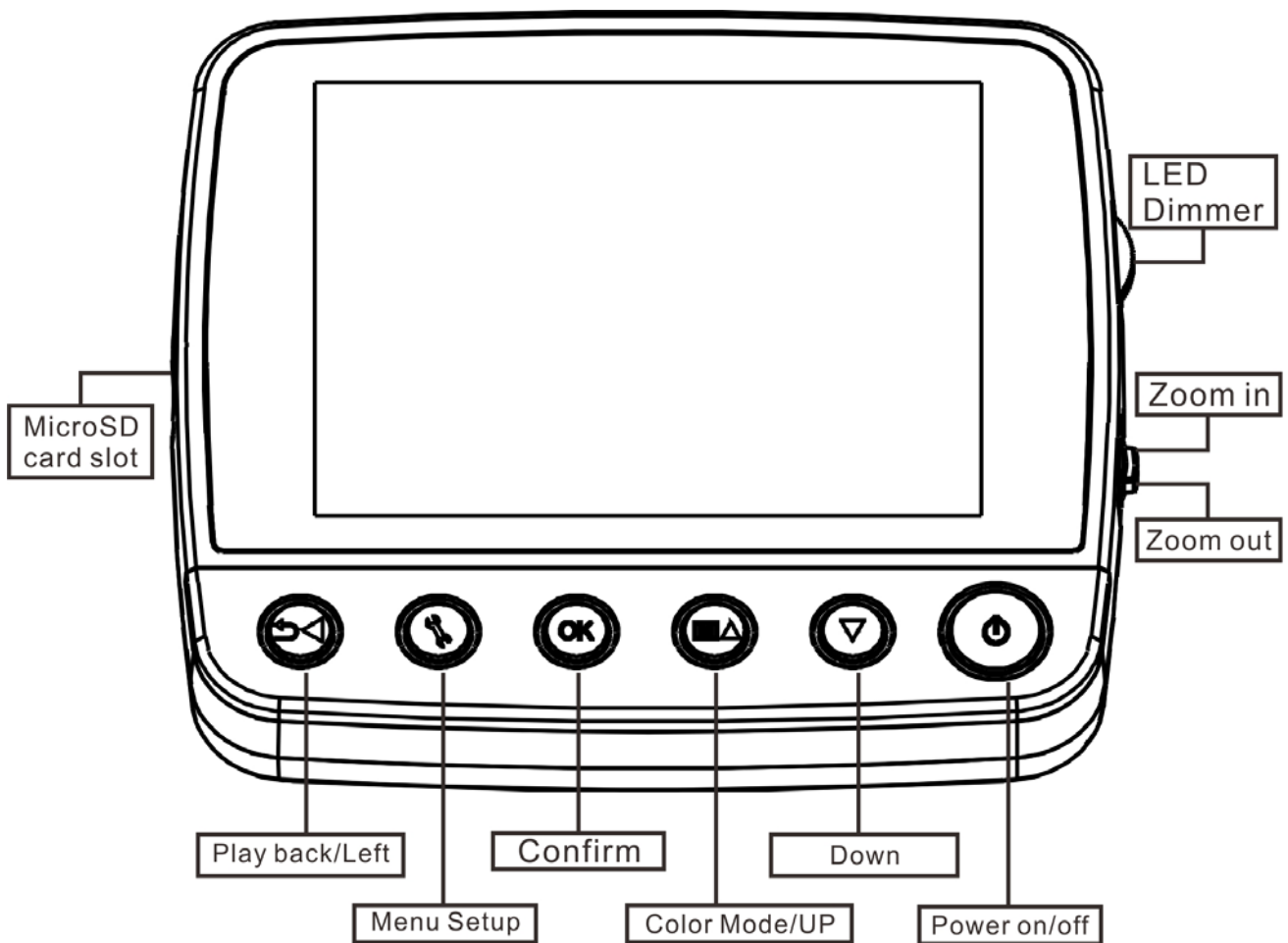

3. Key Features

- 3.5 inches TFT panel
- 5M high quality image sensor (up to 12M by interpolation)
- 20x-250x-500x magnification
- Photo & Video
- Timer
- Measurement (when working on computer)
- Support MicroSD card up to 32GB
- Driver free to download for Windows XP SP2/ Vista/Win7 and Mac OS 10.5 -10.7 (direct plug-in,

driver installation not required)

- Rechargeable Lithium Battery

4. Use the Microscope

EN

4.1 Install battery

- 1). Open the battery door by sliding its door latch..
- 2). Insert the lithium battery to the battery compartment according to the polarities shown in the compartment.

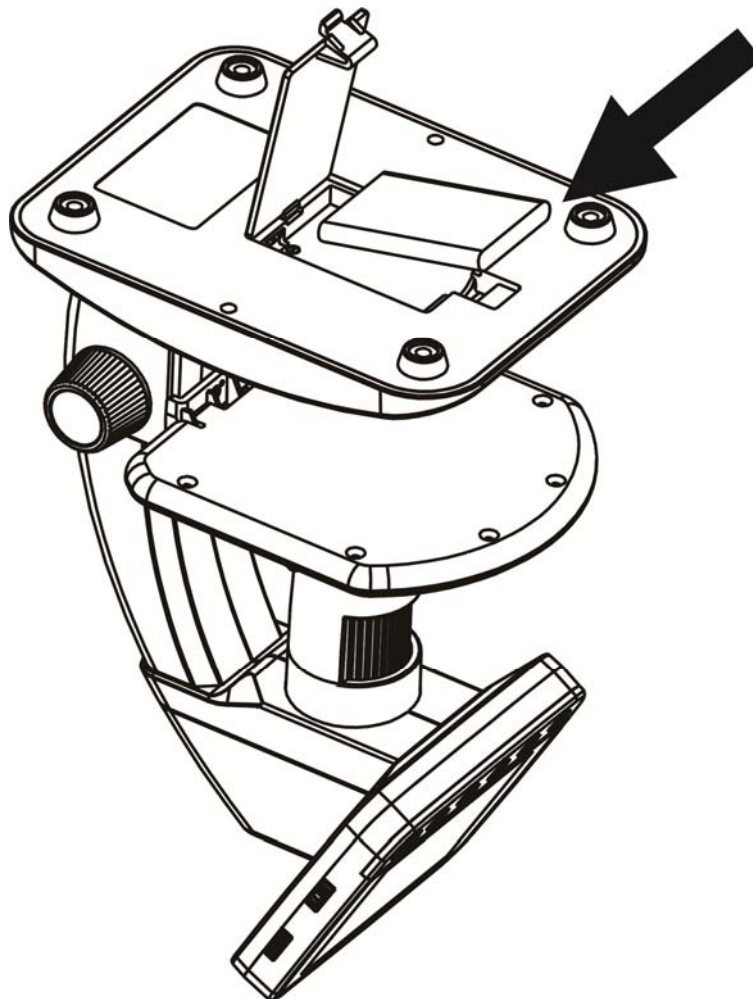

Note: Before using the microscope, you must charge its battery. Please refer to section 4.9 on how to charge the battery.

4.2 Insert a MicroSD Card (not included)

You must insert a MicroSD card (not supplied) to record and store your pictures and videos.

Inserting the MicroSD memory card:

- 1) Turn off the microscope
- 2) Insert the MicroSD card into the MicroSD card slot; gently press in until card is latched.

Note: Do not force the card into the slot; forcing may damage microscope and the MicroSD memory card. Align MicroSD card position (as marked) and try again. The MicroSD memory card must be formatted before capture.



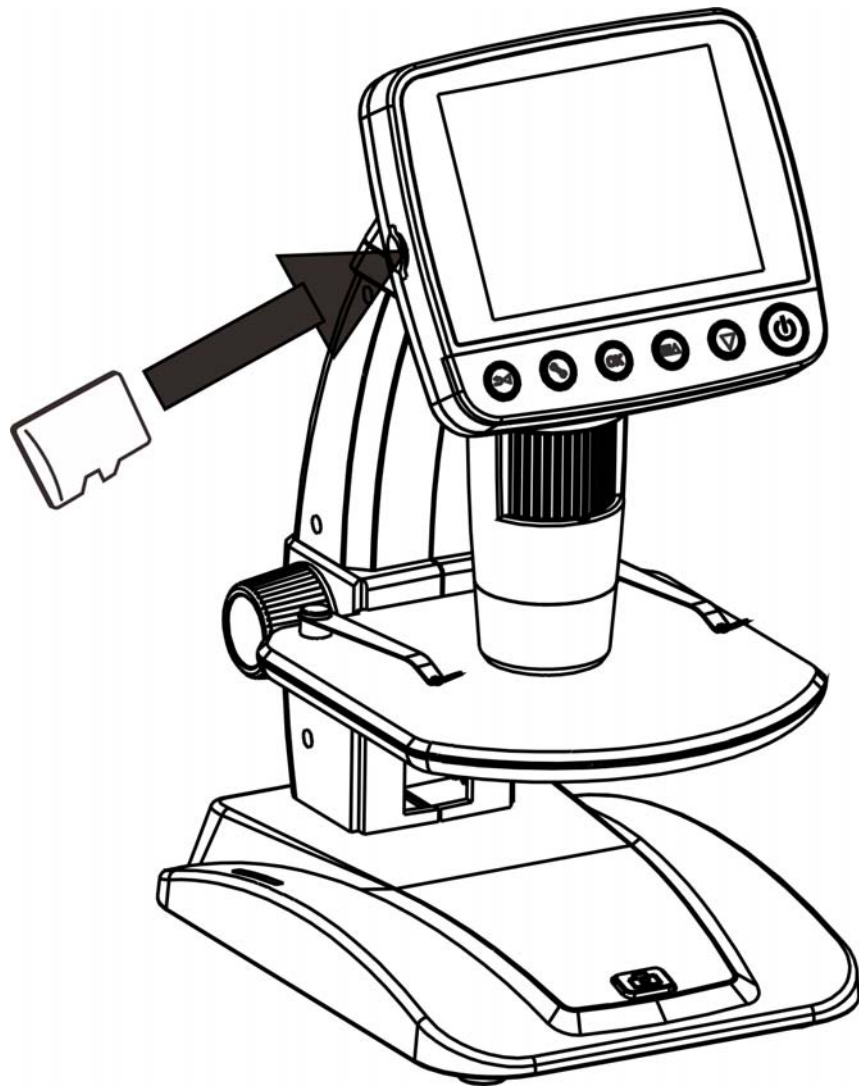



See following instruction and Sec.5.2.5 Format SD.

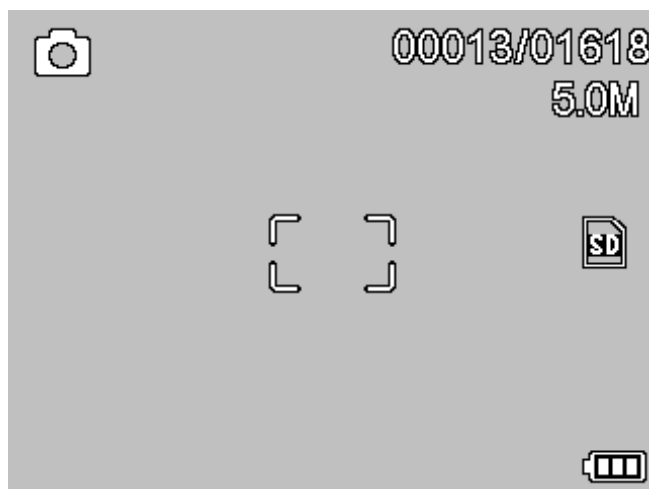

4.3 Display Icons & Meanings

EN



ICON	Meaning
	Still image capture
	Timer capture
	Captured image qty/total qty that could be captured (based on the current resolution)
	MicroSD inserted
	Current resolution
	Battery electricity indicator

Note: The icon displays can be switched on/off by pressing Zoom Wheel¹⁽²⁾ downward vertically.

4.4 Turn on the Microscope

Press on/off button to turn it on.

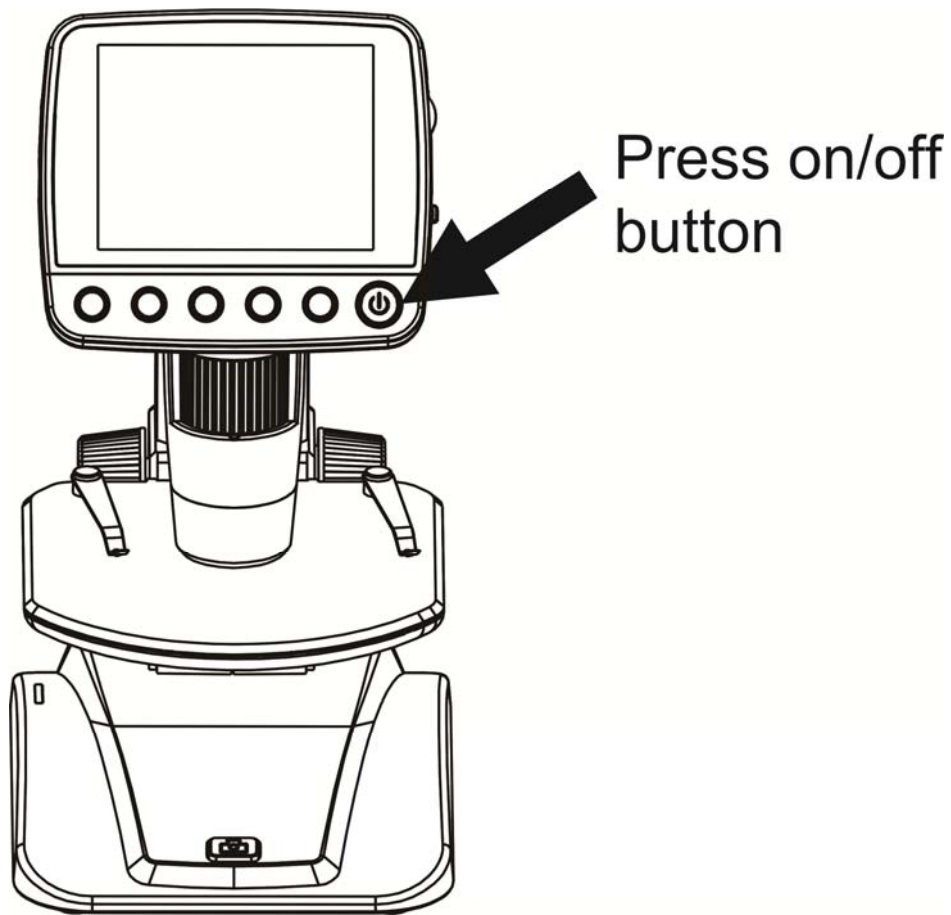

4.5 Turn off the Microscope

- 1) Press on/off button
- 2) By Power Save. Please refer to Section 5.2.2 for Power Save setup.

4.6 How to Capture?

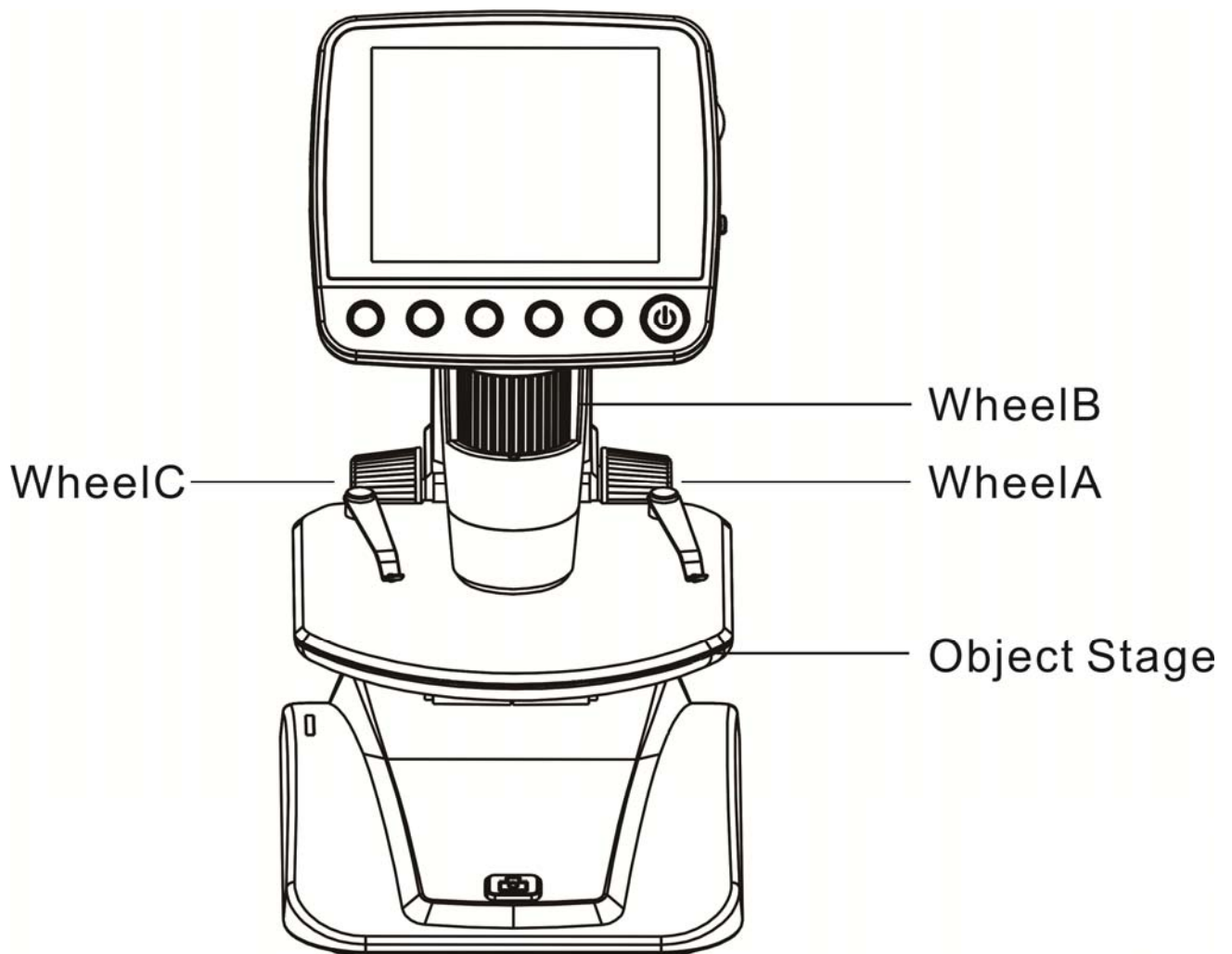

1) Turn on the microscope, put object to be observed onto the object stage.

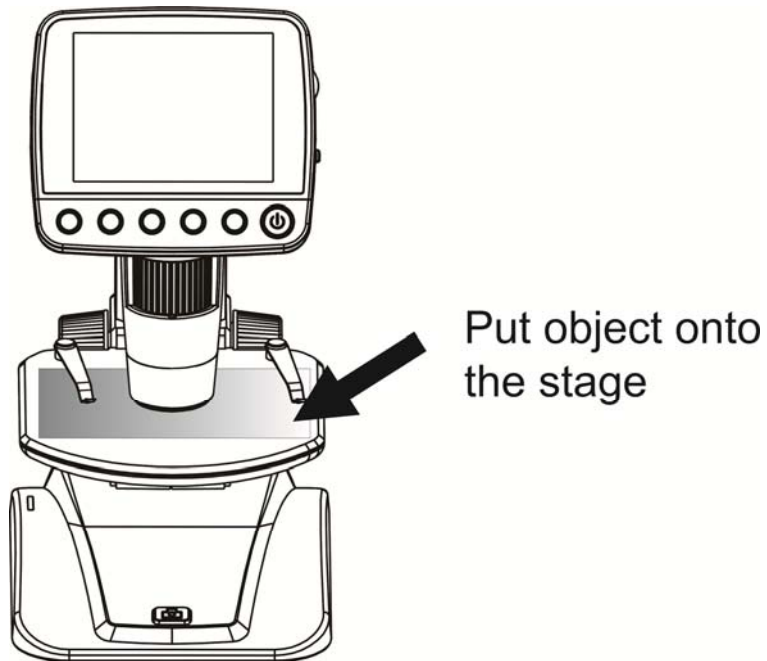

2) Rotate Wheel A to bring the object near to the microscope tube.

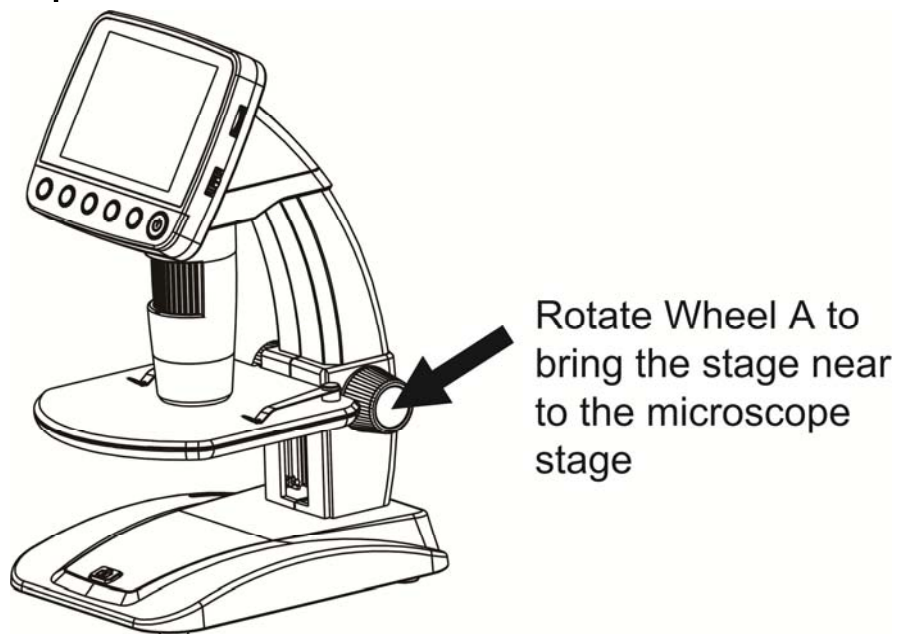

If wheel A is locked, rotate wheel C counter clockwise to release the lock.

3) Rotate Wheel B to get fine focus.

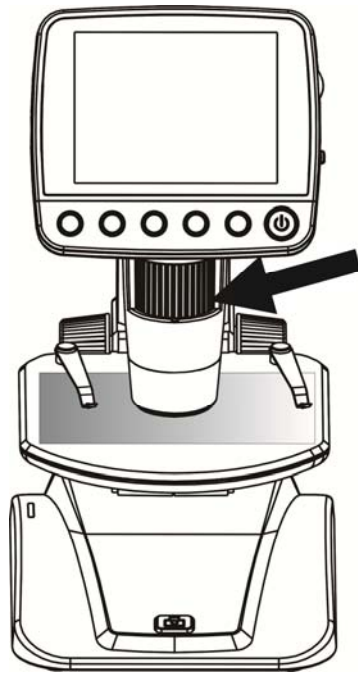

Rotate Wheel B to get a fine focus

4) When a clear focus got, rotate Wheel C clockwise to lock the object stage.

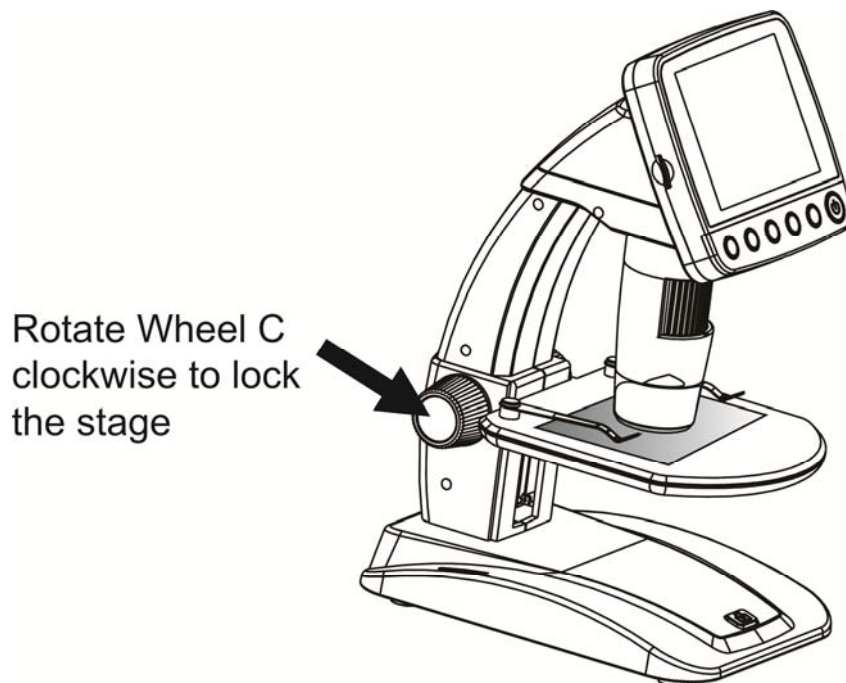

Rotate Wheel C clockwise to lock the stage

5) Take Photo or Record Video

Press Capture button to take a photo or record video.

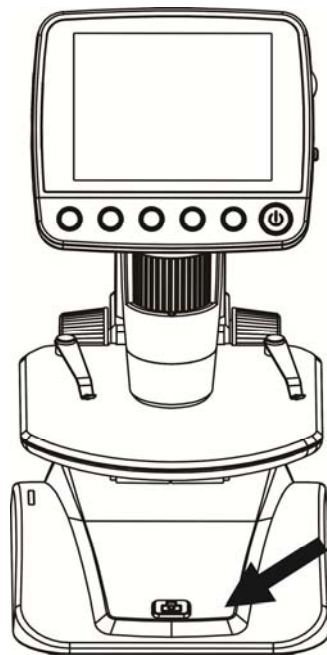

Press Capture button to take a photo or record video

(1) Press Playback/Left to enter video mode as follows. There is video icon on the left corner.

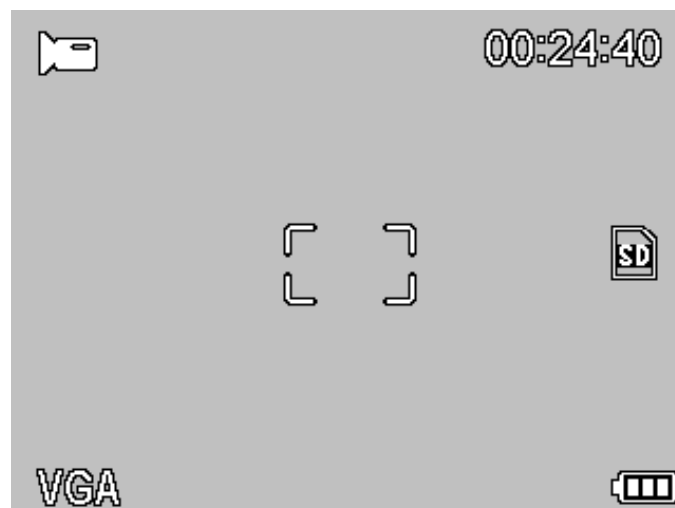

(2) Press Capture button to start recording video. Press again to stop.

6) Play Back

- (1) Press Playback/Left to enter play back mode as follows. There is review icon on the left corner.



- (2) Press UP/DOWN to select among captured pictures and video clips.
- (3) Delete

At play back mode, press  to enter sub-menu as follows, then confirm delete.

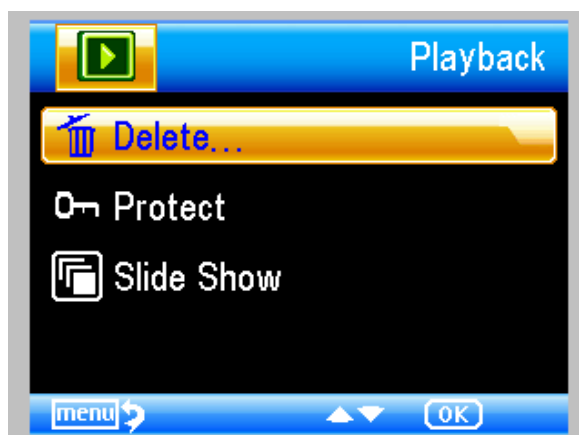

(4) Protect

At play back mode, press  to enter sub-menu as follows, then confirm protect pictures from delete.

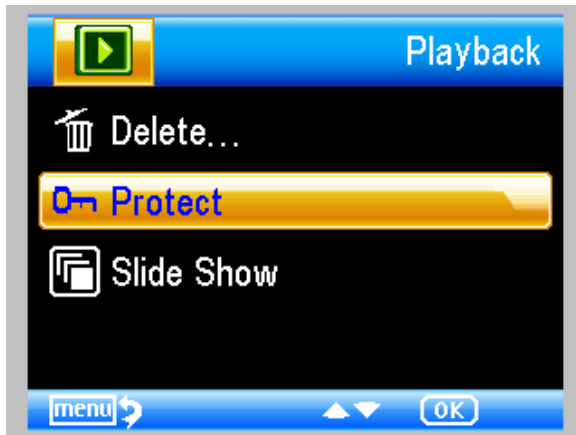



(5) Slide Show

EN

At play back mode, press  to enter sub-menu as follows, select interval time, and then confirm by OK.



7) Color Mode

At preview status, press   to switch among Color/Positive/Negative!

8) **Zoom in:** push Zoom Wheel upwardly

9) **Zoom out:** push Zoom Wheel downwardly

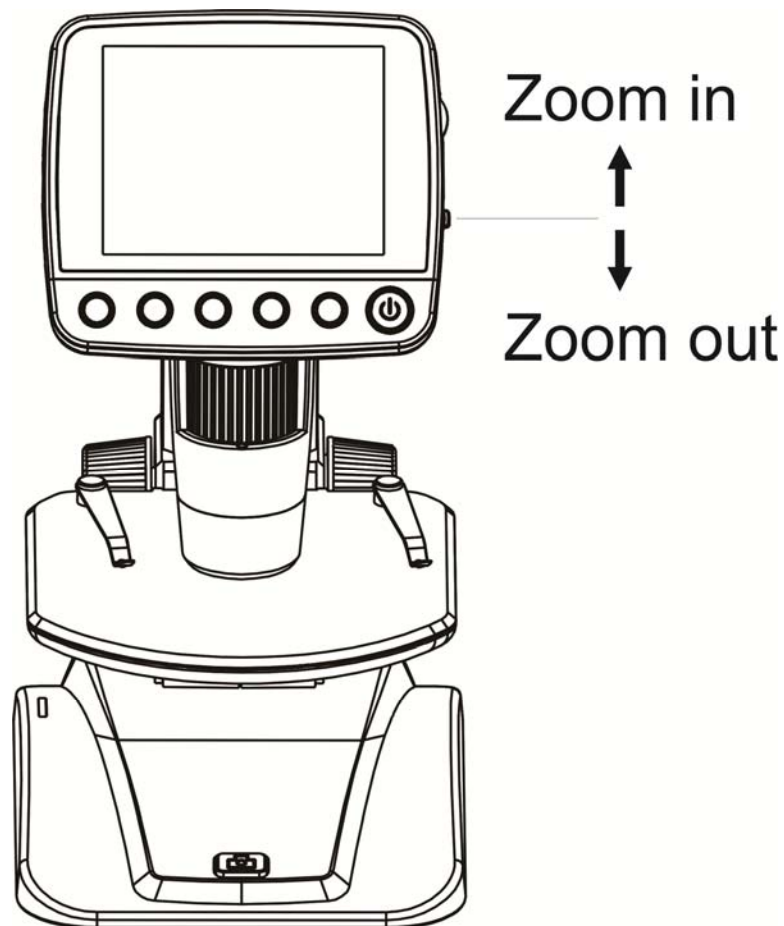

Note: The zoom ranges from 1x – 4.0x

4.7 Download to Computer

- 1) Connect the microscope to computer by USB cable.
- 2) Choose Mass Storage and then you can view stored photos & videos.

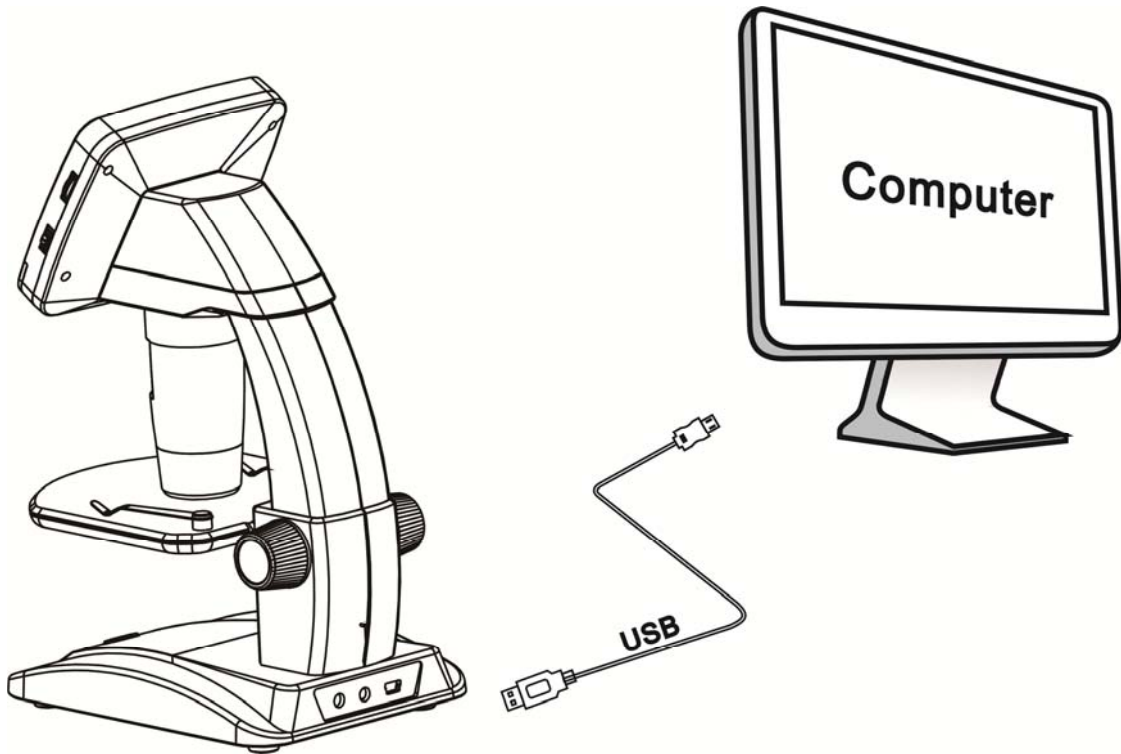

4.8 Preview on Computer

- 1) Connect the microscope to computer by USB cable.
- 2) Choose PC Camera mode
- 3) Start PortableCapture software. Please refer to Part II on how to use the microscope by PortableCapture software.

Note: When working on computer, the button functions are no longer valid, but most of functions are available by PortableCapture software.

4.9 Charge Battery

Before using the microscope, you must charge its battery.

1. Plug the small end of the power adaptor into the DC-in port located on the bottom side of the unit. Then plug the other end of the power adaptor into a standard AC outlet. The battery indicator LED at the end corner of the unit will be in red to show that the battery is charging.

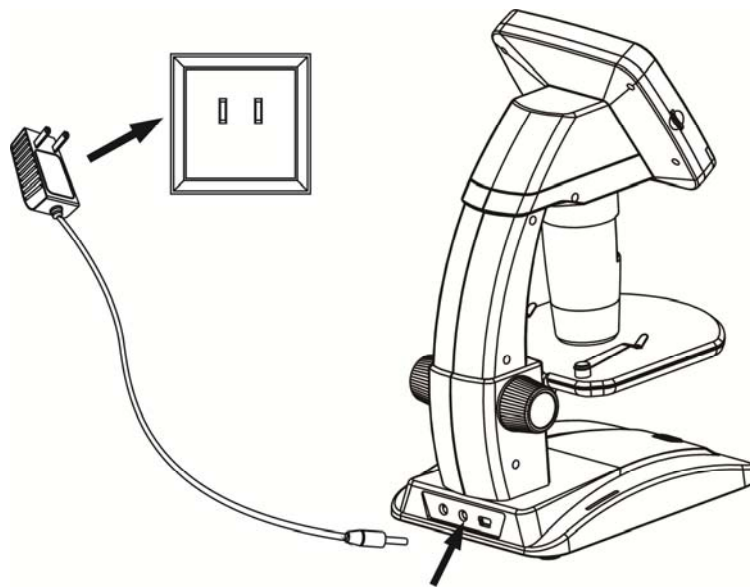

2. When the battery is finished charging, the battery indicator LED will be in off. Unplug the unit.
3. You can now use your microscope for up to two hours of continuous use. When the battery is low, there will be low-power indicator on the right down corner of the panel, front LED light will become weak and image quality becomes poor. Then you have to connect the power adaptor and plug it in to recharge the battery.

4.10 Connect to TV

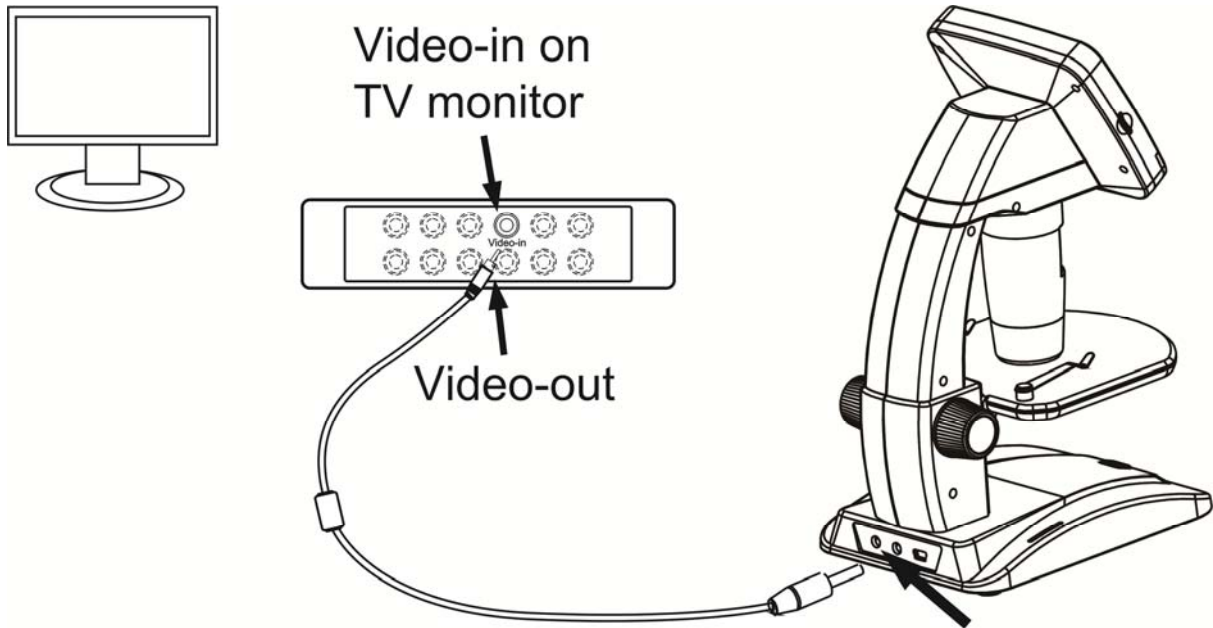

1. Insert the 1/8-inch plug on the end of the supplied video cable into the microscopes Video port.
2. Insert the RCA plug on the video cable into one of your television's yellow video input connectors. Refer to your television's manual for more information on locating these connectors.
3. Turn on the television. If necessary, switch your television to the appropriate input channel. Items that you magnify appear on the television screen.

5.1 Main Menu I

Press  to enter main menu I as follows:



Here you can setup Resolution/Timer/Quality/Sharpness.

5.1.1 Set Resolution

1) From the main menu I, choose Resolution and select a resolution between VGA/1.3M/3M/5M/8M/12M.



2) Press OK to confirm selection.

5.1.2 Timer

1) From the main menu I , choose Timer and then enter Timer setup:

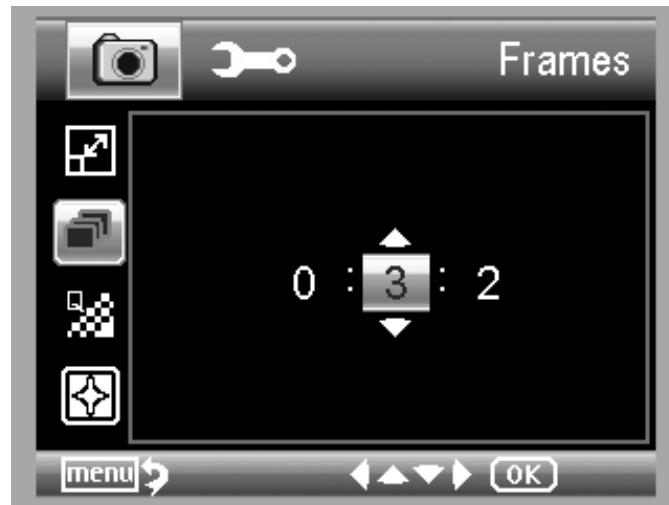

Frames: input quantity of frames you want to take by UP/DOWN and LEFT/RIGHT.

The above setup means 32 frames.



Interval: input interval time between frame capture by UP/DOWN and LEFT/RIGHT.

The above setup means interval time is 15 seconds between each two captures.

- 3) Press OK to confirm selection and press Menu Setup back to preview status. Then press Capture (8) to start auto capture. When at auto capture status, there

is  at the left corner of the screen.

- 4) When all frames captured, microscope will return to normal preview.
- 5) If you need to stop auto capture during the capture process, press Capture one time.

Interval capture is only effective in still image capture mode.

5.1.3 Quality

From the main menu I , choose Quality and then select among Super Fine/Fine/Normal.



The three selections will result in different image compress ratio.

5.1.4 Sharpness

From the main menu I , choose Sharpness and then select among Super Fine/Fine/Normal.

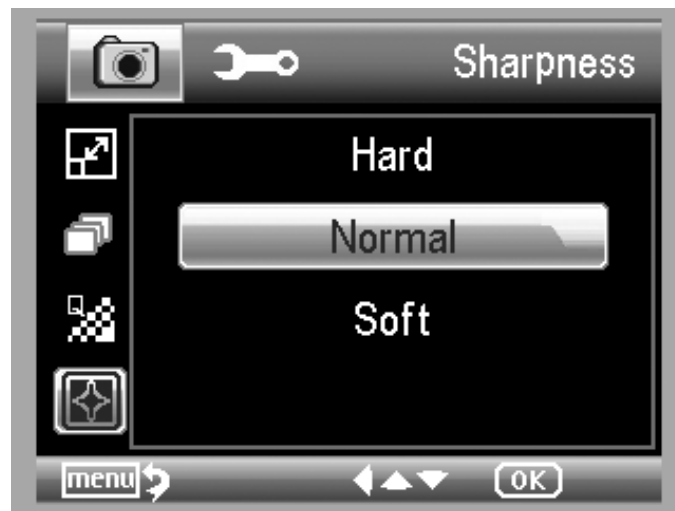

5.2 Main Menu II

Press  to enter main menu I, and then press LEFT to enter Main Menu II as follows:



Here you can setup Language/Power Save/Date Stamp/TV Out/Date and Time/Format SD/System Reset/Version.

5.2.1 Language

EN

From the main menu II, choose Language and then select a target language by UP/DOWN.



5.2.2 Power Save

1) From the main menu II, choose Power Save and then select among the following a target time for the microscope to power off without key operation.



5.2.3 Date Stamp

1) From the main menu II, choose Date Stamp to enter the following menu:



2) Select Date/Time, Date or Off.

Date/Time: both date and time will be marked on images taken.

Date: on date will be marked on images taken

Off: None of date and time info will be marked on images taken.

5.2.4 TV Out

From the main menu II, choose TV Out and then select, between NTSC and PAL, the correct mode compatible with your TV.



5.2.4 Date/time

From the main menu II , choose Date/Time to setup date and time.

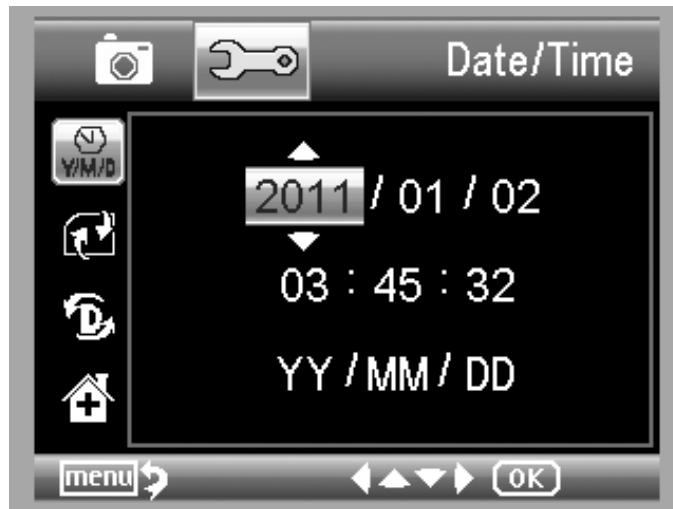

- 1) Setup date and time by LEFT/RIGHT/UP/DOWN
- 2) Setup date mode among YY/MM/DD, DD/MM/YY, and MM/DD/YY.

5.2.5 Format SD

From the main menu II , choose Format SD to format the MicroSD card inserted.

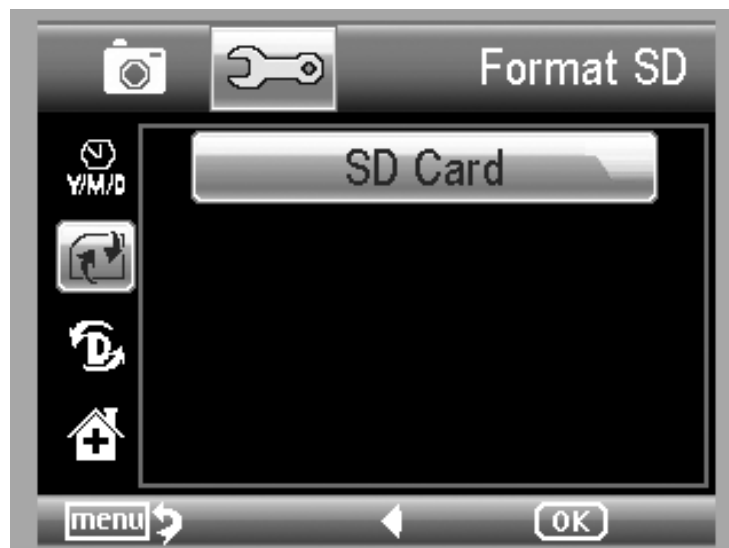

5.2.6 System Reset

From the main menu II, choose Sys. Reset to reset the system back to default.



5.2.7 Version

From the main menu II, choose Version to view the current machine version.

6. Specifications

EN

Image sensor:	5M high quality Image Sensor
Magnifications:	20x-250x-500x
Resolutions:	12M, 8M, 5M, 3M, 1.3M, VGA
Lens:	High quality microscopic lens
Display:	3.5inches TFT panel, 4:3 ratio
Light sources:	8 LEDs with adjustable brightness
Power sources:	Li-ion 3.7V / 800mAh battery Working time: 2 hours; Charging time: 5 hours
Frame rate:	30fps
Adaptor:	Input:100-240V, 50/60Hz; Output: 5V, 1A
OSD languages:	English/Germany/French/Spanish/Italian/ Portugese/Japanese/Chinese
Software languages:	English/Germany/French/Spanish
Image Measurement:	By software
Size:	L149mm*W104mm*H227mm
Weight:	780 gm.(with battery)

7. Computer System Minimum Requirement

Operating system	Windows XP SP2/Vista/Win7, Mac 10.5 -10.7
CPU	Pentium 11 or above
RAM	256MB
Interface	USB port2.0

Problems	Solution
The unit does not turn on.	Charge the battery.
The screen is blank.	<p>Ensure that the power is on.</p> <p>Charge the battery.</p> <p>Verify that the item you want to magnify is Positioned correctly under the lens.</p>
There are smudges or blemishes on the screen	Clean the screen and lens carefully with soft fabric
Microscope is connected to a television, but no image appears on the television screen.	<p>Ensure that the television is on.</p> <p>Switch to the appropriate video input channel on your television.</p> <p>Ensure that the video cable is securely connected to the Microscope Video-out port and plugged into the correct video input on your television.</p>
<p>The battery indicator LED is not in red, even though the power adaptor is connected and plugged into a wall socket.</p> <p>-or-</p> <p>The battery is not charging.</p>	<p>Plugged into the Microscope's DC-in port.</p> <p>Ensure that the outlet has power and is not malfunctioning. If the outlet is connected to a wall switch, make sure that the switch is on.</p>

PortableCapture Pro Software Introduction

■ Install the software

Insert the driver CD into CD-ROM Drive and this will automatically display the following interface:



1. Install the PortableCapture Pro software
Click **PortableCapture Pro software** and then reboot the system when asked.
2. You can also browse the User manual in PDF format and the CD contents by choosing the corresponding menus.

3. Start the Microscope

Connect your Microscope to your PC USB port as shown on Page20, start the software by clicking the

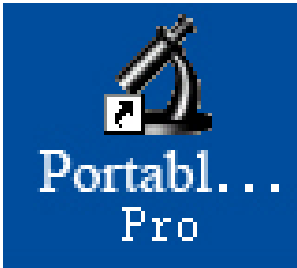

icon generated on the desktop after

installation and you will see the following screen pop up.



5. Software functions

■ Capture Photo



a. Click 'Photo' shortcut icon in the main menu bar.

b. Click 'Capture > Photo'.



■ Capture Video



a. Click 'Video' shortcut icon in the main menu bar.

b. Click 'Capture > Video'.



■ Timer (Photo / Video)

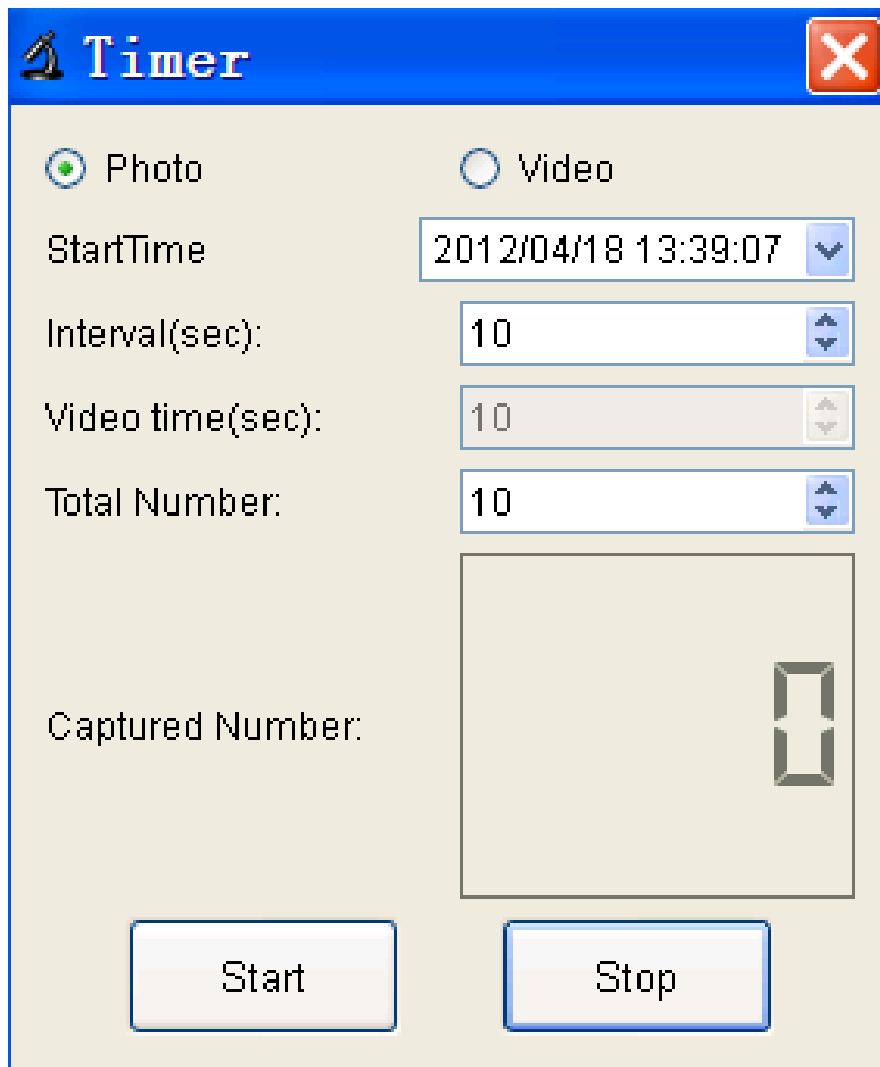

Click 'Timer' shortcut icon in the main menu bar.

A screenshot of the 'Timer' dialog box. The title bar is blue with the text 'Timer' and a close button. The dialog has two radio buttons: 'Photo' (selected) and 'Video'. Below these are several input fields: 'StartTime' (a date and time dropdown set to '2012/04/18 13:39:07'), 'Interval(sec):' (a spinner box set to '10'), 'Video time(sec):' (a spinner box set to '10'), and 'Total Number:' (a spinner box set to '10'). At the bottom, there is a 'Captured Number:' label next to a large empty rectangular box with a small icon on the right. At the very bottom are two buttons: 'Start' and 'Stop'.

* Under Timer photo, you can set the start time, interval time and total picture number.

* Under Timer video, you can set the start time, interval time and total video number.

■ Calibration and Measurement

Please make calibration before measurement.

Calibration

Display Crossing from 'Options>Crossing'.

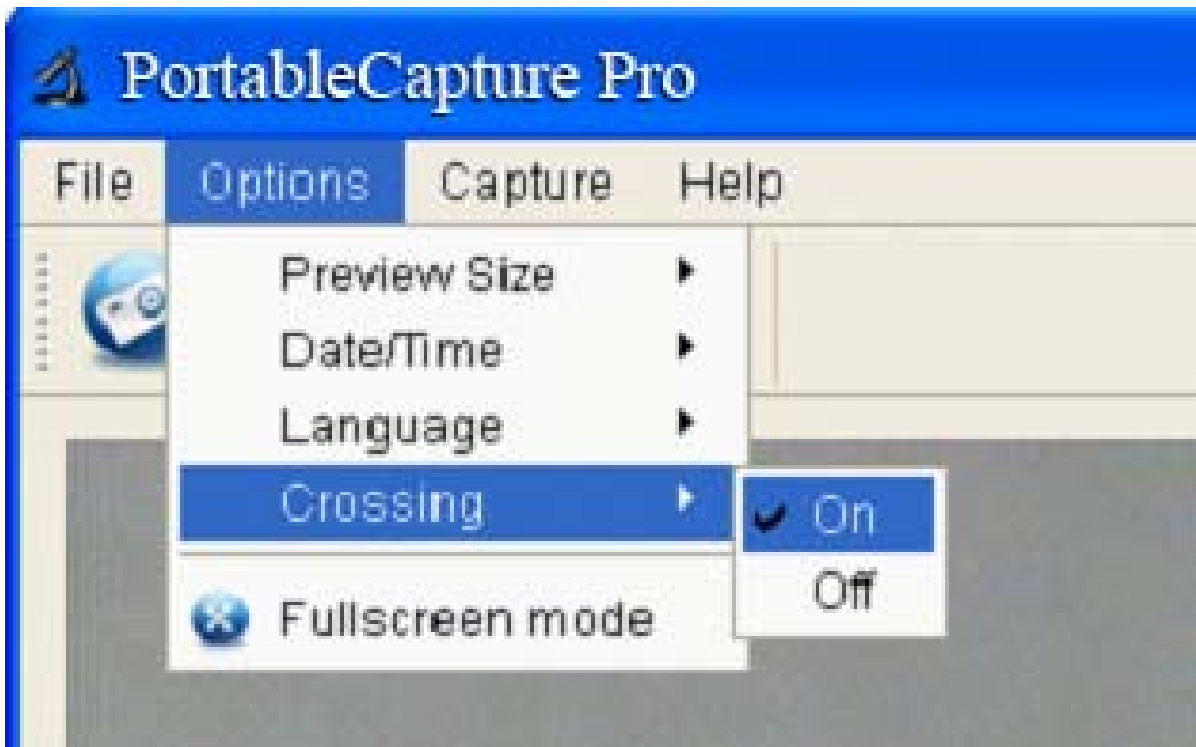

It's used to check the dial is parallel or not.

1. Focus microscope on the attached dial and then adjust the magnification till the picture is clear. Take a picture for the selected area when the dial is parallel to the crossing as below.

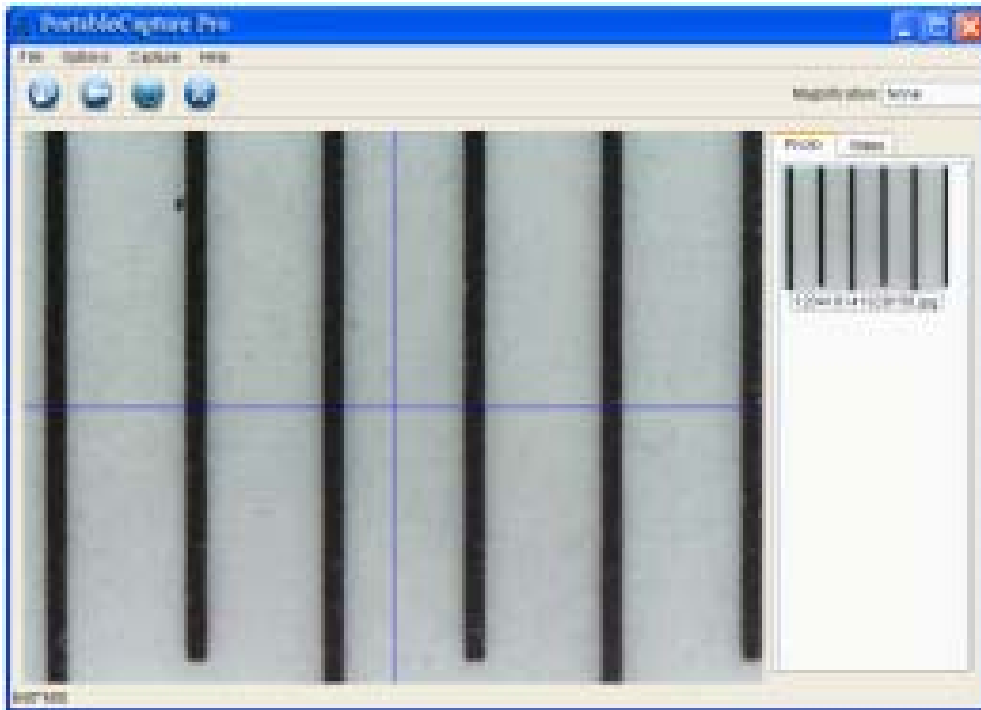

2. Double-click on the picture to enter into measurement interface as below.

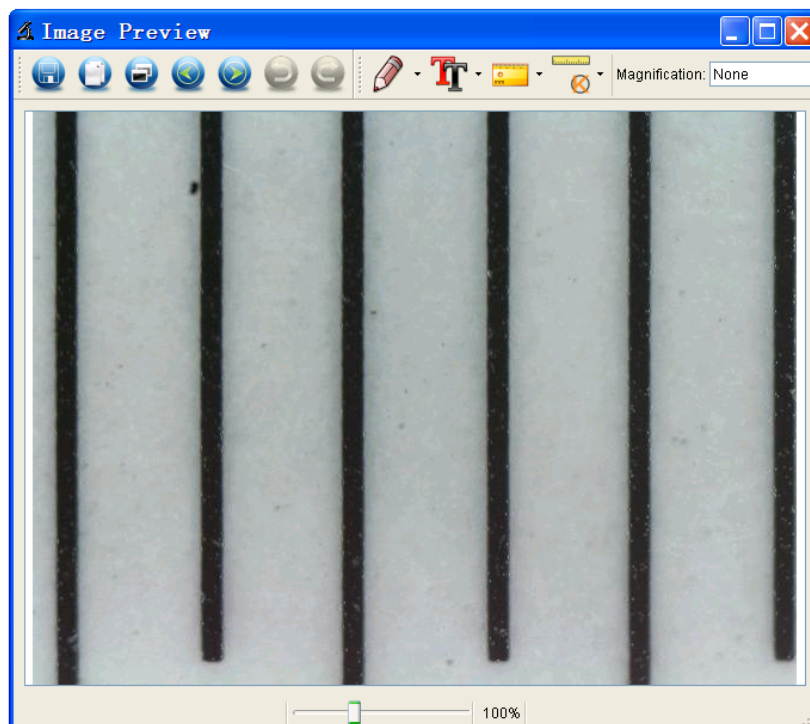

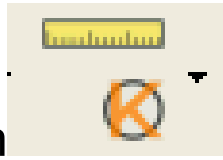

3. Click Calibration icon , and then move mouse to the picture. Click on the beginning and ending points across a known value. Now a dialog will popup as below and you need to enter the exact value of the measurement sample into 'Actual dimension'. Then the software will automatically calibrate the magnification rate. Click 'OK' and the adjusted magnification rate will show in the upper right corner.

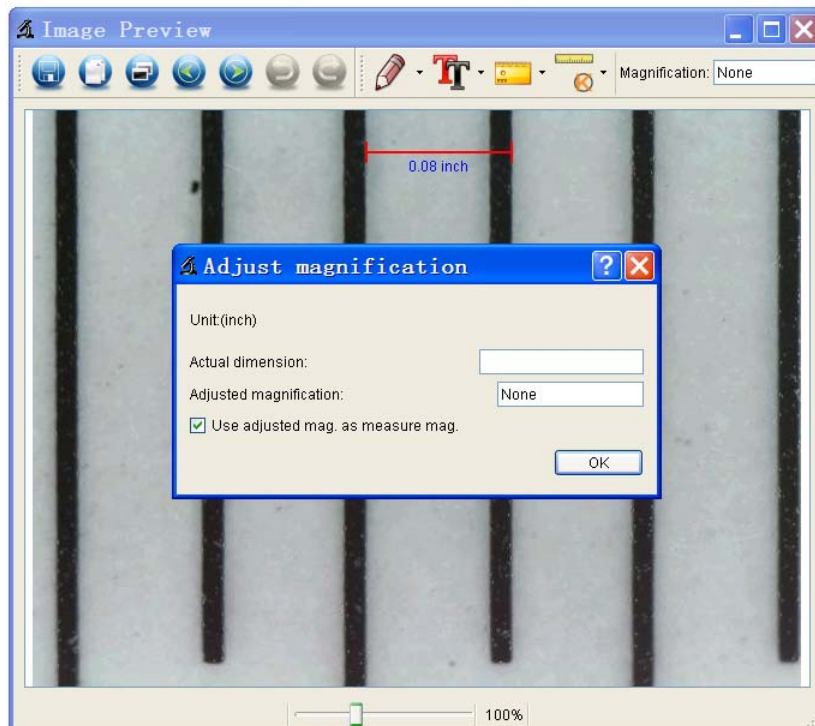

* Remark: The broken line should be parallel to the dial during measurement.

4. Now you can use 'Any angle Line' under Measurement

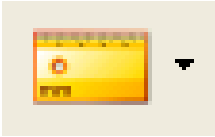
icon  to measure the value again. If the value you measure by software is nearly the same as the exact value of the dial means the calibration finish.

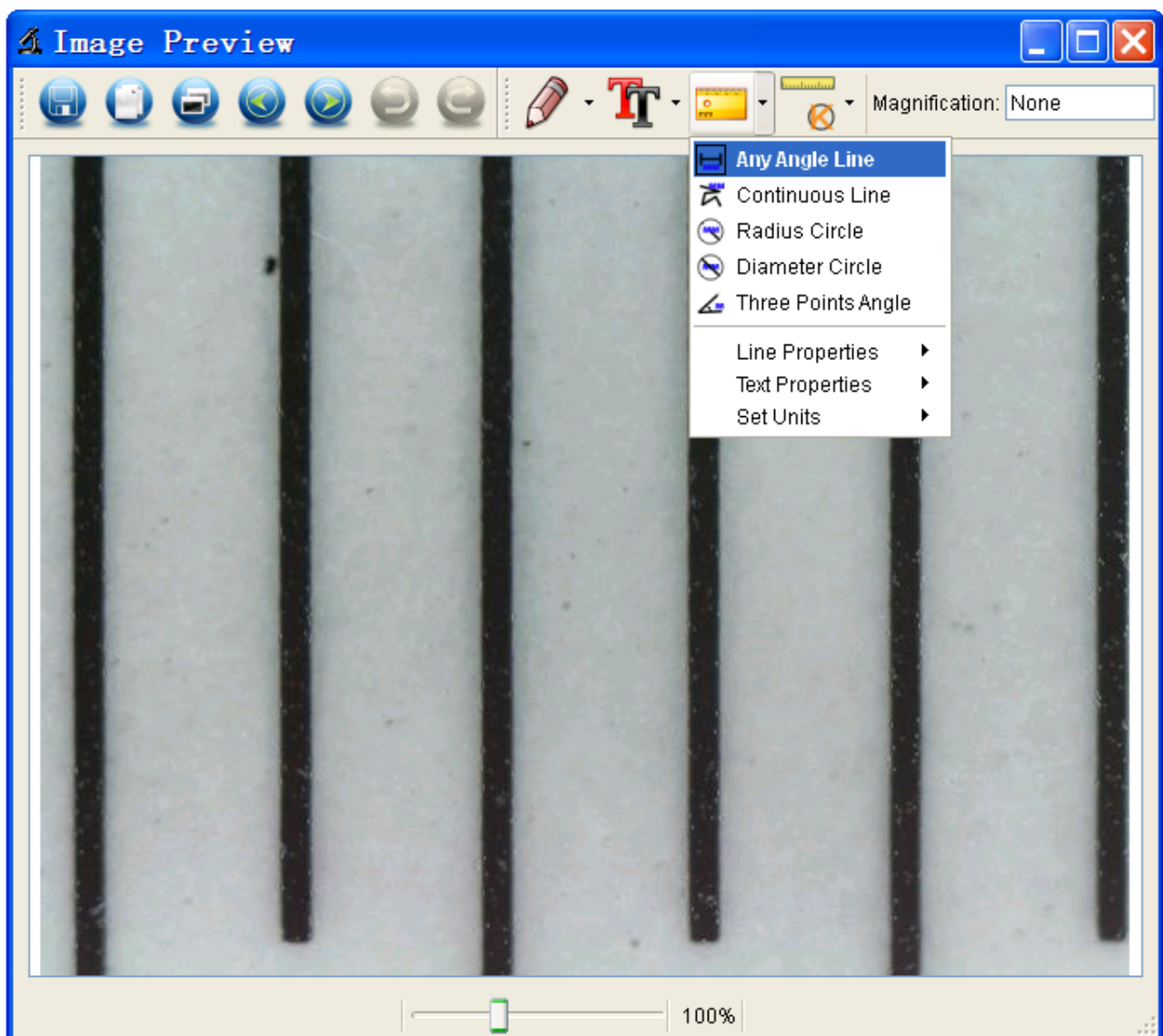

Measurement

Double-click on the picture to enter into measurement

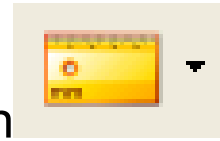

interface. Under the 'Measurement' icon, you can choose any desired options to measure.

1. Any Angle Line Measurement

Simply click from one point and drag to the next point, and then release the click.

2. Continuous Line Measurement

The Continuous Line measurement allows you to measure any continuous desired length.

Simply click and drag from one point to other desired points, and then release the click.

3. Radius Circle Measurement

Simply click and extend out to the desired radius, the radius, circumference and area of the circle will show up accordingly.

4. Diameter Circle Measurement

Simply click and extend out to the desired diameter, the diameter, circumference and area of the circle will show up accordingly.

5. Three Points Angle Measurement

Simply define any three points angle and click, the angle value will then display.

Change Calibration

If you need to change the magnification rate and adjust focus to capture picture, please calibrate the magnification rate again.



1. Double click to open the picture, Click 'Reset magnification > Reset picture magnification' as below. And then start calibration again (Calibration details please refer to page37).

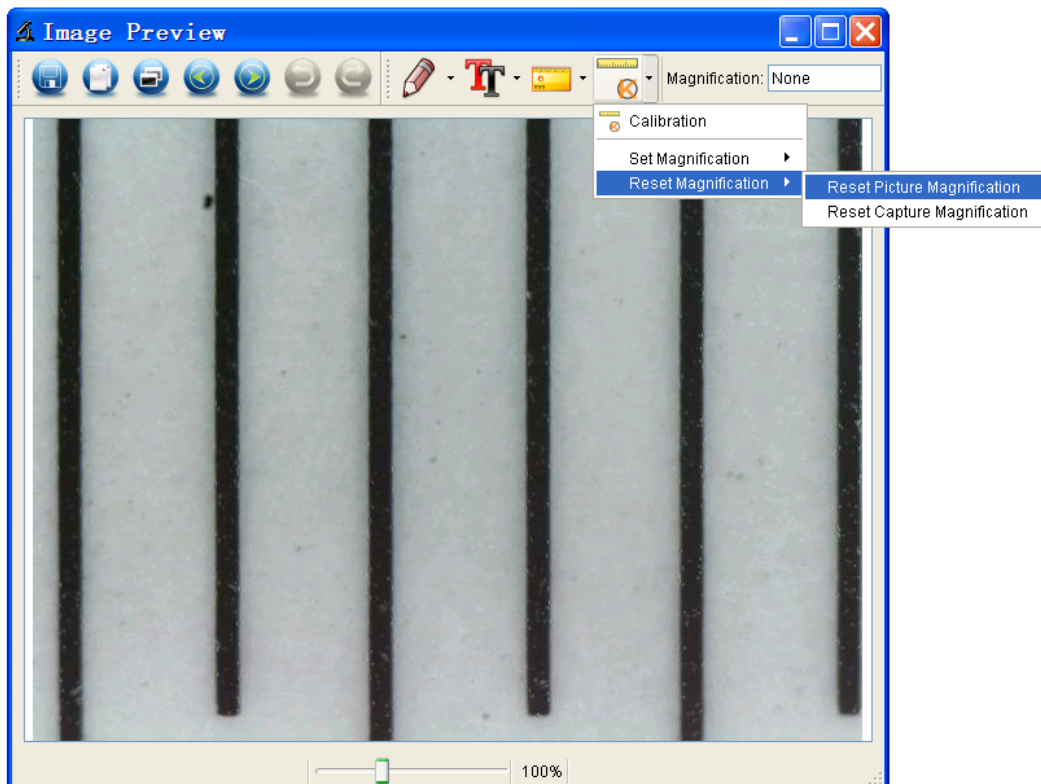

2. Change the magnification rate and capture several pictures, click on the picture to enter into measurement

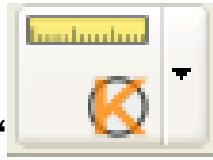

interface. And click 'Set magnification > Set picture magnification', now a dialog will show up as below; enter the magnification rate into the dialog and click 'OK'.

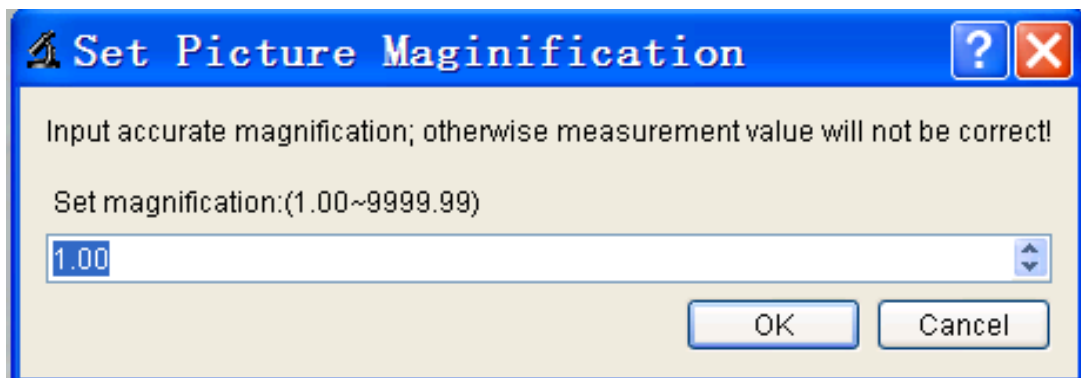
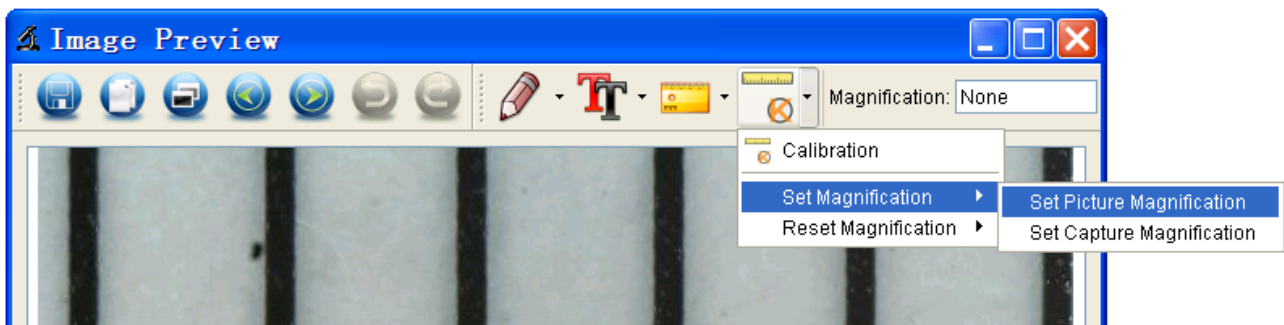

3. If you want to use the same magnification rate to

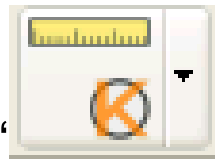

capture pictures, just click '> Set magnification >Set capture magnification'. Now all pictures will use the same magnification rate and you can start measurement directly.

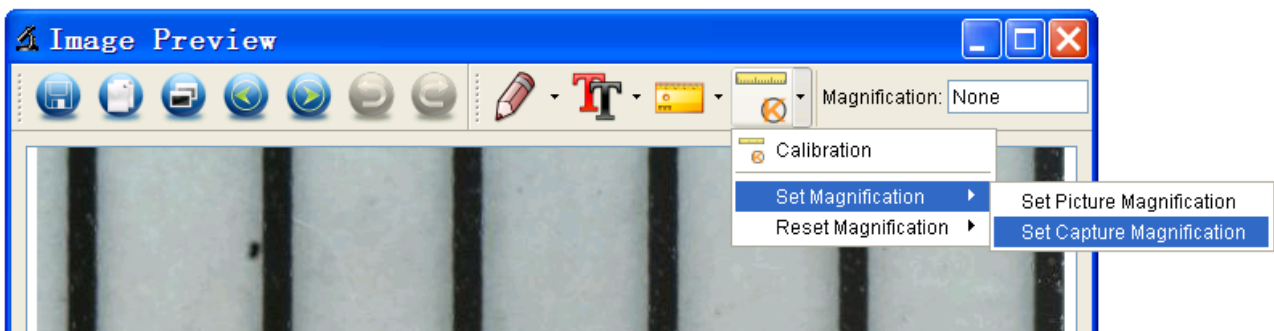

Draw and Text

You can draw or add a text on the picture and save for later analysis.

1. Click icon  to choose any kinds of drawing under the pull-down manual as below.

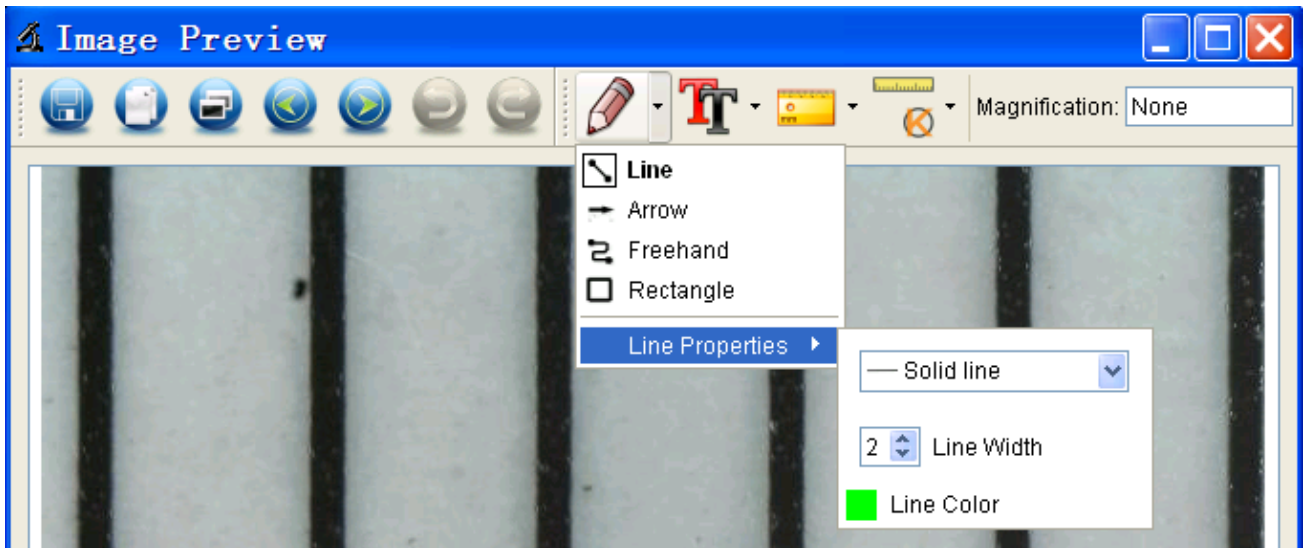

2. Click icon  and set the font for the text in the popup dialogue as below.

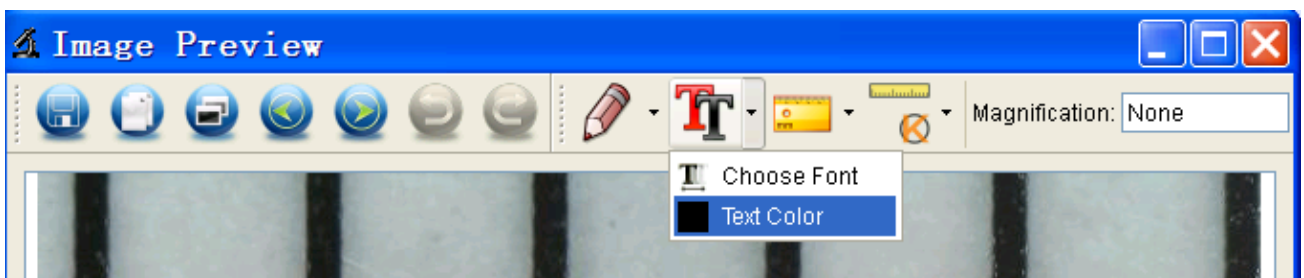

6. Software Interface Instructions

Main Interface Icons



Capture photo – It's used to capture photo one by one.



Start / Stop record video.

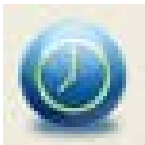

Timer for photo / video – Set the start time, interval time and total photo/video number.



Full screen mode,
Press ESC or double-click to exit.

Main Menu

File



Photos Directory: set the directory to store photos taken;

Videos Directory: set the directory to store video taken;

Options

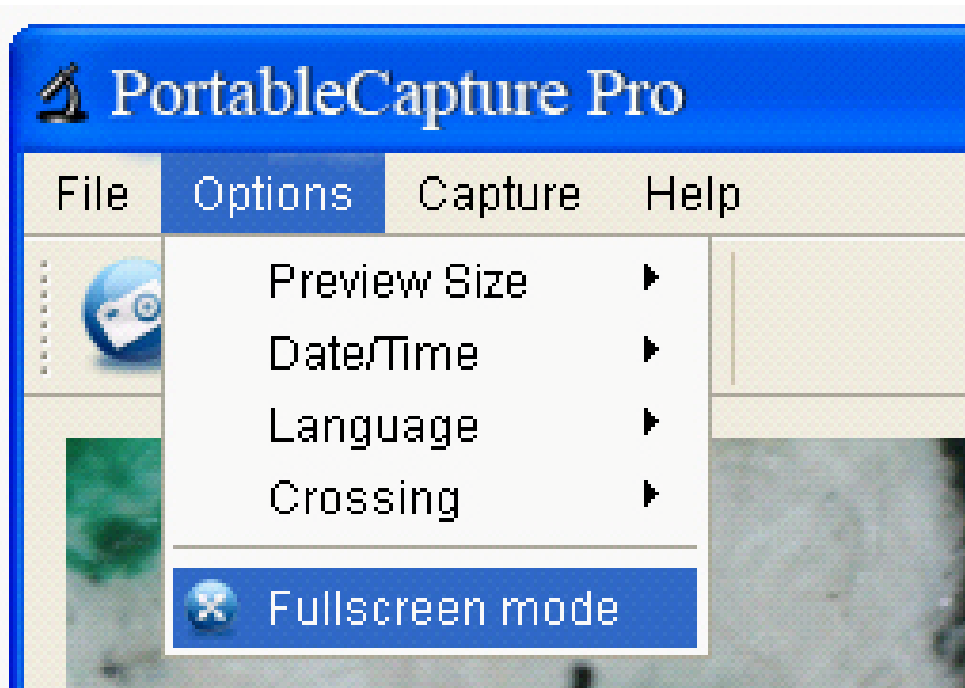

Preview Size: change preview size

Date/Time: set to display system date/time on preview window

Language: choose different OSD language

Crossing: display cross on preview window

Fullscreen mode: enter into full screen. Click ESC or double click to exit

Capture



Photo: take a photo

Video: record a video clip

Measurement Interface Instructions



Save as



Redo



Copy to
clipboard



Draw



Copy file



Text note



Previous



Measurement



Next



Calibration



Undo

This symbol on the product or in the instructions means that your electrical and electronic equipment should be disposed at the end of its life separately from your household waste. There are separate collection systems for recycling in the EU. For more information, please contact the local authority or your retailer where you purchased the product.

