



Multilayer ceramic capacitors

Leaded, C0G

Series/Type: **Leaded C0G**

Date: February 2009

The following products presented in this data sheet are being withdrawn.

Substitute Products: See www.epcos.com/withdrawal_mlcc

Ordering Code	Substitute Product	Date of Withdrawal	Deadline Last Orders	Last Shipments
B37979N1221J000		2009-06-26	2010-06-30	2010-12-31
B37979N1331J054		2009-06-26	2010-06-30	2010-12-31
B37979N1331J051		2009-06-26	2010-06-30	2010-12-31

© EPCOS AG 2009. Reproduction, publication and dissemination of this publication, enclosures hereto and the information contained therein without EPCOS' prior express consent is prohibited.



Ordering Code	Substitute Product	Date of Withdrawal	Deadline Last Orders	Last Shipments
B37979N1331J000		2009-06-26	2010-06-30	2010-12-31
B37979N1471J054		2009-06-26	2010-06-30	2010-12-31
B37979N1471J051		2009-06-26	2010-06-30	2010-12-31
B37979N1471J000		2009-06-26	2010-06-30	2010-12-31
B37979N1681J054		2009-06-26	2010-06-30	2010-12-31
B37979N1681J051		2009-06-26	2010-06-30	2010-12-31
B37979N1681J000		2009-06-26	2010-06-30	2010-12-31
B37979N1102J054		2009-06-26	2010-06-30	2010-12-31
B37979N1102J051		2009-06-26	2010-06-30	2010-12-31
B37979N1102J000		2009-06-26	2010-06-30	2010-12-31
B37986N5332J054		2009-06-26	2010-06-30	2010-12-31
B37979G1151J054		2009-06-26	2010-06-30	2010-12-31
B37979G1151J051		2009-06-26	2010-06-30	2010-12-31
B37979G1151J000		2009-06-26	2010-06-30	2010-12-31
B37979G1221J054		2009-06-26	2010-06-30	2010-12-31
B37979G1221J051		2009-06-26	2010-06-30	2010-12-31
B37986N5332J051		2009-06-26	2010-06-30	2010-12-31
B37986N5332J000		2009-06-26	2010-06-30	2010-12-31
B37986N5472J054		2009-06-26	2010-06-30	2010-12-31
B37986N5472J051		2009-06-26	2010-06-30	2010-12-31
B37986N5472J000		2009-06-26	2010-06-30	2010-12-31
B37979G1221J000		2009-06-26	2010-06-30	2010-12-31
B37979G1331J054		2009-06-26	2010-06-30	2010-12-31
B37979G1331J051		2009-06-26	2010-06-30	2010-12-31
B37979G1331J000		2009-06-26	2010-06-30	2010-12-31
B37979G1471J054		2009-06-26	2010-06-30	2010-12-31
B37986N5682J054		2009-06-26	2010-06-30	2010-12-31
B37986N5682J051		2009-06-26	2010-06-30	2010-12-31
B37986N5682J000		2009-06-26	2010-06-30	2010-12-31
B37986N5103J054		2009-06-26	2010-06-30	2010-12-31
B37986N5103J051		2009-06-26	2010-06-30	2010-12-31
B37979G1471J051		2009-06-26	2010-06-30	2010-12-31
B37979G1471J000		2009-06-26	2010-06-30	2010-12-31
B37979G1681J054		2009-06-26	2010-06-30	2010-12-31
B37979G1681J051		2009-06-26	2010-06-30	2010-12-31
B37979G1681J000		2009-06-26	2010-06-30	2010-12-31
B37986N5103J000		2009-06-26	2010-06-30	2010-12-31
B37986N1152J054		2009-06-26	2010-06-30	2010-12-31



Ordering Code	Substitute Product	Date of Withdrawal	Deadline Last Orders	Last Shipments
B37986N1152J051		2009-06-26	2010-06-30	2010-12-31
B37986N1152J000		2009-06-26	2010-06-30	2010-12-31
B37986N1222J054		2009-06-26	2010-06-30	2010-12-31
B37979G1102J054		2009-06-26	2010-06-30	2010-12-31
B37979G1102J051		2009-06-26	2010-06-30	2010-12-31
B37979G1102J000		2009-06-26	2010-06-30	2010-12-31
B37979G5101J054		2009-06-26	2010-06-30	2010-12-31
B37979G5101J051		2009-06-26	2010-06-30	2010-12-31
B37986N1222J051		2009-06-26	2010-06-30	2010-12-31
B37986N1222J000		2009-06-26	2010-06-30	2010-12-31
B37979G5101J000		2009-06-26	2010-06-30	2010-12-31
B37979G5151J054		2009-06-26	2010-06-30	2010-12-31
B37979G5151J051		2009-06-26	2010-06-30	2010-12-31
B37979G5151J000		2009-06-26	2010-06-30	2010-12-31
B37979G5221J054		2009-06-26	2010-06-30	2010-12-31
B37979G5221J051		2009-06-26	2010-06-30	2010-12-31
B37979G5221J000		2009-06-26	2010-06-30	2010-12-31
B37979G5331J054		2009-06-26	2010-06-30	2010-12-31
B37979G5331J051		2009-06-26	2010-06-30	2010-12-31
B37979G5331J000		2009-06-26	2010-06-30	2010-12-31
B37979G5471J054		2009-06-26	2010-06-30	2010-12-31
B37979G5471J051		2009-06-26	2010-06-30	2010-12-31
B37979G5471J000		2009-06-26	2010-06-30	2010-12-31
B37979N5101J054		2009-06-26	2010-06-30	2010-12-31
B37979N5101J051		2009-06-26	2010-06-30	2010-12-31
B37979N5101J000		2009-06-26	2010-06-30	2010-12-31
B37986G5332J054		2009-06-26	2010-06-30	2010-12-31
B37986G5332J051		2009-06-26	2010-06-30	2010-12-31
B37986G5332J000		2009-06-26	2010-06-30	2010-12-31
B37986G5472J054		2009-06-26	2010-06-30	2010-12-31
B37986G5472J051		2009-06-26	2010-06-30	2010-12-31
B37986G5472J000		2009-06-26	2010-06-30	2010-12-31
B37986G5682J054		2009-06-26	2010-06-30	2010-12-31
B37986G5682J051		2009-06-26	2010-06-30	2010-12-31
B37986G5682J000		2009-06-26	2010-06-30	2010-12-31
B37986G5103J054		2009-06-26	2010-06-30	2010-12-31
B37986G5103J051		2009-06-26	2010-06-30	2010-12-31
B37986G5103J000		2009-06-26	2010-06-30	2010-12-31



Ordering Code	Substitute Product	Date of Withdrawal	Deadline Last Orders	Last Shipments
B37986G1152J054		2009-06-26	2010-06-30	2010-12-31
B37986G1152J051		2009-06-26	2010-06-30	2010-12-31
B37986G1152J000		2009-06-26	2010-06-30	2010-12-31
B37986G1222J054		2009-06-26	2010-06-30	2010-12-31
B37986G1222J051		2009-06-26	2010-06-30	2010-12-31
B37986G1222J000		2009-06-26	2010-06-30	2010-12-31
B37979N5151J054		2009-06-26	2010-06-30	2010-12-31
B37979N5151J051		2009-06-26	2010-06-30	2010-12-31
B37979N5151J000		2009-06-26	2010-06-30	2010-12-31
B37979N5221J054		2009-06-26	2010-06-30	2010-12-31
B37979N5221J051		2009-06-26	2010-06-30	2010-12-31
B37979N5221J000		2009-06-26	2010-06-30	2010-12-31
B37979N5331J054		2009-06-26	2010-06-30	2010-12-31
B37979N5331J051		2009-06-26	2010-06-30	2010-12-31
B37979N5331J000		2009-06-26	2010-06-30	2010-12-31
B37979N5471J054		2009-06-26	2010-06-30	2010-12-31
B37979N5471J051		2009-06-26	2010-06-30	2010-12-31
B37979N5471J000		2009-06-26	2010-06-30	2010-12-31
B37979N5681J054		2009-06-26	2010-06-30	2010-12-31
B37979N5681J051		2009-06-26	2010-06-30	2010-12-31
B37979N5681J000		2009-06-26	2010-06-30	2010-12-31
B37979N5102J054		2009-06-26	2010-06-30	2010-12-31
B37979N5102J051		2009-06-26	2010-06-30	2010-12-31
B37979N5102J000		2009-06-26	2010-06-30	2010-12-31
B37979N5152J054		2009-06-26	2010-06-30	2010-12-31
B37979N5152J051		2009-06-26	2010-06-30	2010-12-31
B37979N5152J000		2009-06-26	2010-06-30	2010-12-31
B37979N5222J054		2009-06-26	2010-06-30	2010-12-31
B37979N5222J051		2009-06-26	2010-06-30	2010-12-31
B37979N5222J000		2009-06-26	2010-06-30	2010-12-31
B37979N1100J054		2009-06-26	2010-06-30	2010-12-31
B37979N1100J051		2009-06-26	2010-06-30	2010-12-31
B37979N1100J000		2009-06-26	2010-06-30	2010-12-31
B37979N1150J054		2009-06-26	2010-06-30	2010-12-31
B37979N1150J051		2009-06-26	2010-06-30	2010-12-31
B37979N1150J000		2009-06-26	2010-06-30	2010-12-31
B37979G5681J054		2009-06-26	2010-06-30	2010-12-31
B37979G5681J051		2009-06-26	2010-06-30	2010-12-31



Ordering Code	Substitute Product	Date of Withdrawal	Deadline Last Orders	Last Shipments
B37979G5681J000		2009-06-26	2010-06-30	2010-12-31
B37979N1220J054		2009-06-26	2010-06-30	2010-12-31
B37979N1220J051		2009-06-26	2010-06-30	2010-12-31
B37979N1220J000		2009-06-26	2010-06-30	2010-12-31
B37979N1330J054		2009-06-26	2010-06-30	2010-12-31
B37979N1330J051		2009-06-26	2010-06-30	2010-12-31
B37979G5102J054		2009-06-26	2010-06-30	2010-12-31
B37979G5102J051		2009-06-26	2010-06-30	2010-12-31
B37979G5102J000		2009-06-26	2010-06-30	2010-12-31
B37979G5152J054		2009-06-26	2010-06-30	2010-12-31
B37979G5152J051		2009-06-26	2010-06-30	2010-12-31
B37979N1330J000		2009-06-26	2010-06-30	2010-12-31
B37979N1470J054		2009-06-26	2010-06-30	2010-12-31
B37979N1470J051		2009-06-26	2010-06-30	2010-12-31
B37979N1470J000		2009-06-26	2010-06-30	2010-12-31
B37979N1680J054		2009-06-26	2010-06-30	2010-12-31
B37979G5152J000		2009-06-26	2010-06-30	2010-12-31
B37979G5222J054		2009-06-26	2010-06-30	2010-12-31
B37979G5222J051		2009-06-26	2010-06-30	2010-12-31
B37979G5222J000		2009-06-26	2010-06-30	2010-12-31
B37979G1100J054		2009-06-26	2010-06-30	2010-12-31
B37979N1680J051		2009-06-26	2010-06-30	2010-12-31
B37979N1680J000		2009-06-26	2010-06-30	2010-12-31
B37979N1101J054		2009-06-26	2010-06-30	2010-12-31
B37979N1101J051		2009-06-26	2010-06-30	2010-12-31
B37979N1101J000		2009-06-26	2010-06-30	2010-12-31
B37979G1100J051		2009-06-26	2010-06-30	2010-12-31
B37979G1100J000		2009-06-26	2010-06-30	2010-12-31
B37979G1150J054		2009-06-26	2010-06-30	2010-12-31
B37979G1150J051		2009-06-26	2010-06-30	2010-12-31
B37979G1150J000		2009-06-26	2010-06-30	2010-12-31
B37979N1151J054		2009-06-26	2010-06-30	2010-12-31
B37979N1151J051		2009-06-26	2010-06-30	2010-12-31
B37979N1151J000		2009-06-26	2010-06-30	2010-12-31
B37979N1221J054		2009-06-26	2010-06-30	2010-12-31
B37979N1221J051		2009-06-26	2010-06-30	2010-12-31
B37979G1220J054		2009-06-26	2010-06-30	2010-12-31
B37979G1220J051		2009-06-26	2010-06-30	2010-12-31



Ordering Code	Substitute Product	Date of Withdrawal	Deadline Last Orders	Last Shipments
B37979G1220J000		2009-06-26	2010-06-30	2010-12-31
B37979G1330J054		2009-06-26	2010-06-30	2010-12-31
B37979G1330J051		2009-06-26	2010-06-30	2010-12-31
B37979G1330J000		2009-06-26	2010-06-30	2010-12-31
B37979G1470J054		2009-06-26	2010-06-30	2010-12-31
B37979G1470J051		2009-06-26	2010-06-30	2010-12-31
B37979G1470J000		2009-06-26	2010-06-30	2010-12-31
B37979G1680J054		2009-06-26	2010-06-30	2010-12-31
B37979G1680J051		2009-06-26	2010-06-30	2010-12-31
B37979G1680J000		2009-06-26	2010-06-30	2010-12-31
B37979G1101J054		2009-06-26	2010-06-30	2010-12-31
B37979G1101J051		2009-06-26	2010-06-30	2010-12-31
B37979G1101J000		2009-06-26	2010-06-30	2010-12-31

For further information please contact your nearest EPCOS sales office, which will also support you in selecting a suitable substitute. The addresses of our worldwide sales network are presented at www.epcos.com/sales.

C0G

C0G

Ordering code system

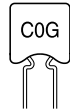

B37979N	1	101	J	0	54																		
<table border="1"> <thead> <tr> <th colspan="2">Type and size</th> <th rowspan="2">Temperature characteristic C0G</th> </tr> </thead> <tbody> <tr> <td>With radial leads EIA standards</td> <td></td> <td></td> </tr> <tr> <td rowspan="2">Lead spacing 2.5 mm</td> <td>5.5 × 5.0 × 2.5</td> <td>B37979N</td> </tr> <tr> <td>6.5 × 5.0 × 2.5</td> <td>B37986N</td> </tr> <tr> <td rowspan="3">Lead spacing 5.0 mm</td> <td>5.5 × 5.0 × 2.5</td> <td>B37979G</td> </tr> <tr> <td>6.5 × 5.0 × 2.5</td> <td>B37986G</td> </tr> <tr> <td>9.0 × 7.5 × 2.5</td> <td>–</td> </tr> </tbody> </table>						Type and size		Temperature characteristic C0G	With radial leads EIA standards			Lead spacing 2.5 mm	5.5 × 5.0 × 2.5	B37979N	6.5 × 5.0 × 2.5	B37986N	Lead spacing 5.0 mm	5.5 × 5.0 × 2.5	B37979G	6.5 × 5.0 × 2.5	B37986G	9.0 × 7.5 × 2.5	–
Type and size		Temperature characteristic C0G																					
With radial leads EIA standards																							
Lead spacing 2.5 mm	5.5 × 5.0 × 2.5	B37979N																					
	6.5 × 5.0 × 2.5	B37986N																					
Lead spacing 5.0 mm	5.5 × 5.0 × 2.5	B37979G																					
	6.5 × 5.0 × 2.5	B37986G																					
	9.0 × 7.5 × 2.5	–																					
<table border="1"> <thead> <tr> <th>Rated voltage</th> </tr> </thead> <tbody> <tr> <td>5 (Code) \triangleq 50 VDC</td> </tr> <tr> <td>1 (Code) \triangleq 100 VDC</td> </tr> </tbody> </table>						Rated voltage	5 (Code) \triangleq 50 VDC	1 (Code) \triangleq 100 VDC															
Rated voltage																							
5 (Code) \triangleq 50 VDC																							
1 (Code) \triangleq 100 VDC																							
<table border="1"> <thead> <tr> <th>Capacitance, coded (example)</th> </tr> </thead> <tbody> <tr> <td>101 \triangleq 10 · 10¹ pF = 100 pF</td> </tr> <tr> <td>222 \triangleq 22 · 10² pF = 2.2 nF</td> </tr> <tr> <td>473 \triangleq 47 · 10³ pF = 47 nF</td> </tr> </tbody> </table>						Capacitance, coded (example)	101 \triangleq 10 · 10 ¹ pF = 100 pF	222 \triangleq 22 · 10 ² pF = 2.2 nF	473 \triangleq 47 · 10 ³ pF = 47 nF														
Capacitance, coded (example)																							
101 \triangleq 10 · 10 ¹ pF = 100 pF																							
222 \triangleq 22 · 10 ² pF = 2.2 nF																							
473 \triangleq 47 · 10 ³ pF = 47 nF																							
<table border="1"> <thead> <tr> <th>Capacitance tolerance</th> </tr> </thead> <tbody> <tr> <td>J \triangleq \pm5% (standard for C0G)</td> </tr> </tbody> </table>						Capacitance tolerance	J \triangleq \pm 5% (standard for C0G)																
Capacitance tolerance																							
J \triangleq \pm 5% (standard for C0G)																							
<table border="1"> <thead> <tr> <th>Internal coding</th> </tr> </thead> <tbody> <tr> <td> </td> </tr> </tbody> </table>						Internal coding																	
Internal coding																							
<table border="1"> <thead> <tr> <th>Packaging</th> </tr> </thead> <tbody> <tr> <td>51 \triangleq cardboard tape, reel packing (360-mm reel)</td> </tr> <tr> <td>54 \triangleq Ammo packing (standard)</td> </tr> <tr> <td>00 \triangleq bulk</td> </tr> </tbody> </table>						Packaging	51 \triangleq cardboard tape, reel packing (360-mm reel)	54 \triangleq Ammo packing (standard)	00 \triangleq bulk														
Packaging																							
51 \triangleq cardboard tape, reel packing (360-mm reel)																							
54 \triangleq Ammo packing (standard)																							
00 \triangleq bulk																							

Features

- Good thermal stability
- High insulation resistance
- Low dissipation factor
- Low inductance

Applications

- Resonant circuits
- Filter circuits
- Timing elements
- Coupling and filtering, particularly in RF circuits

Termination

- Parallel wire leads, iron-nickel, tinned
- Crimped leads
- Non-standard lead lengths on request

Marking

- Rated capacitance, tolerance, manufacturer's logo, ceramic material, voltage

Options

- Alternative capacitance values and tolerances available on request

Delivery mode

- Cardboard tape in Ammo packing (standard)
- Cardboard tape on 360-mm reel or bulk on request

Electrical data

Temperature characteristic			C0G	
Climatic category	(IEC 60068-1)		55/125/56	
Standard			EIA	
Dielectric			Class 1	
Rated voltage		V_R	50, 100	VDC
Test voltage		V_{rest}	$2.5 \cdot V_R/5$ s	VDC
Capacitance range		C_R	10 pF ... 10 nF (E6)	
Temperature coefficient			$0 \pm 30 \cdot 10^{-6}/K$	
Dissipation factor	(limit value)	$\tan \delta$	$< 1.0 \cdot 10^{-3}$	
Insulation resistance ¹⁾	(at +25 °C)	R_{ins}	$> 10^5$	MΩ
Insulation resistance ¹⁾	(at +125 °C)	R_{ins}	$> 10^4$	MΩ
Time constant ¹⁾	(at +25 °C)	τ	> 1000	s
Time constant ¹⁾	(at +125 °C)	τ	> 100	s
Operating temperature range		T_{op}	-55 ... +125	°C
Ageing			none	

1) For $C_R > 10$ nF the time constant $\tau = C \cdot R_{ins}$ is given.

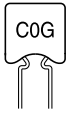

Multilayer ceramic capacitors

COG

Capacity tolerance

Code letter	J (standard)	K
Tolerance	±5 %	±10 %

Dimensional drawing

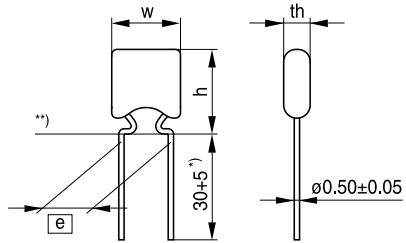



^{*)} Lead length for bulk packaging

^{**)} Seating plane to IEC 600717

KKE0456-R-E

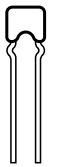
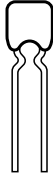
Dimensions (mm)

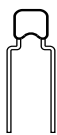
	Lead spacing $[e] = 2.5 +0.6/-0.1$ mm	
Type	B37979N	B37986N
		
h_{max}	5.5	6.0
w_{max}	5.0	5.0
th_{max}	2.5	2.5

	Lead spacing $[e] = 5.0 +0.6/-0.1$ mm	
Type	B37979G	B37986G
		
h_{max}	5.5	6.5
w_{max}	5.0	5.0
th_{max}	2.5	2.5

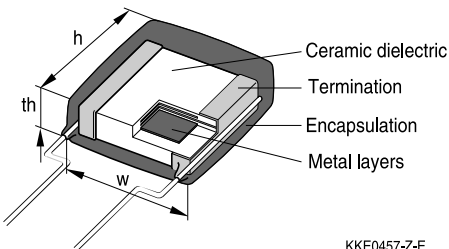

Termination

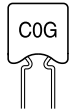

KKE0457-Z-E

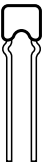

Product range for leaded capacitors, C0G

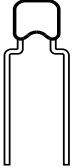
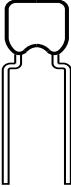
Lead spacing	2.5 mm				5.0 mm			
								
h x w x th	5.5 × 5.0 × 2.5		6.5 × 5.0 × 2.5		5.5 × 5.0 × 2.5		6.5 × 5.0 × 2.5	
Type	B37979N		B37986N		B37979G		B37986G	
$C_R \setminus V_R$ (VDC)	50	100	50	100	50	100	50	100
10 pF								
15 pF								
22 pF								
33 pF								
47 pF								
68 pF								
100 pF								
150 pF								
220 pF								
330 pF								
470 pF								
680 pF								
1.0 nF								
1.5 nF								
2.2 nF								
3.3 nF								
4.7 nF								
6.8 nF								
10 nF								

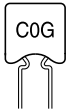
Multilayer ceramic capacitors
COG
Ordering codes and packing for COG, 50 VDC, lead spacing 2.5 mm

C _R	Ordering code	Ammo packing	Reel packing	Bulk
		** \triangle 54	** \triangle 51	** \triangle 00
		pcs.	pcs./reel	pcs.

B37979N, 50 VDC

100 pF	B37979N5101J0**	2500	2500	2000
150 pF	B37979N5151J0**	2500	2500	2000
220 pF	B37979N5221J0**	2500	2500	2000
330 pF	B37979N5331J0**	2500	2500	2000
470 pF	B37979N5471J0**	2500	2500	2000
680 pF	B37979N5681J0**	2500	2500	2000
1.0 nF	B37979N5102J0**	2500	2500	2000
1.5 nF	B37979N5152J0**	2500	2500	2000
2.2 nF	B37979N5222J0**	2500	2500	2000

B37986N, 50 VDC

3.3 nF	B37986N5332J0**	2500	2500	2000
4.7 nF	B37986N5472J0**	2500	2500	2000
6.8 nF	B37986N5682J0**	2500	2500	2000
10 nF	B37986N5103J0**	2500	2500	2000

Ordering codes and packing for COG, 50 VDC, lead spacing 5.0 mm

C _R	Ordering code	Ammo packing	Reel packing	Bulk
		** \triangle 54	** \triangle 51	** \triangle 00
		pcs.	pcs./reel	pcs.

B37979G, 50 VDC

100 pF	B37979G5101J0**	2500	2500	2000
150 pF	B37979G5151J0**	2500	2500	2000
220 pF	B37979G5221J0**	2500	2500	2000
330 pF	B37979G5331J0**	2500	2500	2000
470 pF	B37979G5471J0**	2500	2500	2000
680 pF	B37979G5681J0**	2500	2500	2000
1.0 nF	B37979G5102J0**	2500	2500	2000
1.5 nF	B37979G5152J0**	2500	2500	2000
2.2 nF	B37979G5222J0**	2500	2500	2000

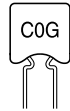
Ordering codes and packing for C0G, 50 VDC, lead spacing 5.0 mm

C _R	Ordering code	Ammo packing	Reel packing	Bulk
		** \triangle 54	** \triangle 51	** \triangle 00
		pcs.	pcs./reel	pcs.
B37986G, 50 VDC				
3.3 nF	B37986G5332J0**	2500	2500	2000
4.7 nF	B37986G5472J0**	2500	2500	2000
6.8 nF	B37986G5682J0**	2500	2500	2000
10 nF	B37986G5103J0**	2500	2500	2000

Ordering codes and packing for C0G, 100 VDC, lead spacing 2.5 mm

C _R	Ordering code	Ammo packing	Reel packing	Bulk
		** \triangle 54	** \triangle 51	** \triangle 00
		pcs.	pcs./reel	pcs.
B37979N, 100 VDC				
10 pF	B37979N1100J0**	2500	2500	2000
15 pF	B37979N1150J0**	2500	2500	2000
22 pF	B37979N1220J0**	2500	2500	2000
33 pF	B37979N1330J0**	2500	2500	2000
47 pF	B37979N1470J0**	2500	2500	2000
68 pF	B37979N1680J0**	2500	2500	2000
100 pF	B37979N1101J0**	2500	2500	2000
150 pF	B37979N1151J0**	2500	2500	2000
220 pF	B37979N1221J0**	2500	2500	2000
330 pF	B37979N1331J0**	2500	2500	2000
470 pF	B37979N1471J0**	2500	2500	2000
680 pF	B37979N1681J0**	2500	2500	2000
1.0 nF	B37979N1102J0**	2500	2500	2000
B37986N, 100 VDC				
1.5 nF	B37986N1152J0**	2500	2500	2000
2.2 nF	B37986N1222J0**	2500	2500	2000

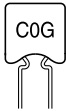
Multilayer ceramic capacitors
COG
Ordering codes and packing for COG, 100 VDC, lead spacing 5.0 mm

C _R	Ordering code	Ammo packing	Reel packing	Bulk
		** \triangle 54	** \triangle 51	** \triangle 00
		pcs.	pcs./reel	pcs.

B37979G, 100 VDC

10 pF	B37979G1100J0**	2500	2500	2000
15 pF	B37979G1150J0**	2500	2500	2000
22 pF	B37979G1220J0**	2500	2500	2000
33 pF	B37979G1330J0**	2500	2500	2000
47 pF	B37979G1470J0**	2500	2500	2000
68 pF	B37979G1680J0**	2500	2500	2000
100 pF	B37979G1101J0**	2500	2500	2000
150 pF	B37979G1151J0**	2500	2500	2000
220 pF	B37979G1221J0**	2500	2500	2000
330 pF	B37979G1331J0**	2500	2500	2000
470 pF	B37979G1471J0**	2500	2500	2000
680 pF	B37979G1681J0**	2500	2500	2000
1.0 nF	B37979G1102J0**	2500	2500	2000

B37986G, 100 VDC

1.5 nF	B37986G1152J0**	2500	2500	2000
2.2 nF	B37986G1222J0**	2500	2500	2000

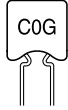

Typical characteristics

Capacitance change $\Delta C/C_{25}$ versus temperature T

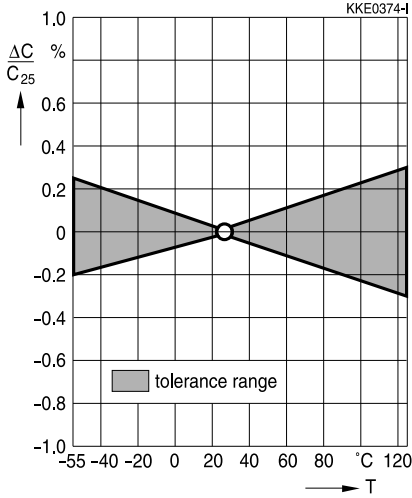

Capacitance change $\Delta C/C_0$ versus superimposed DC voltage V

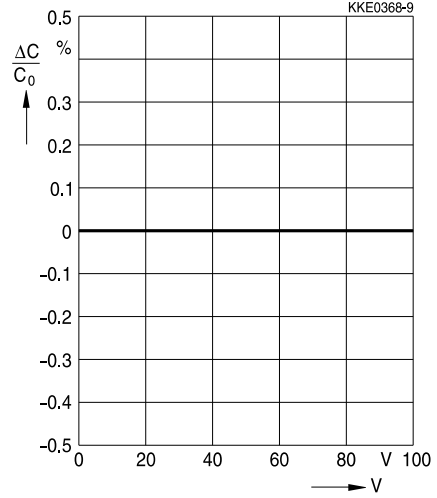

Insulation resistance R_{ins} versus temperature T

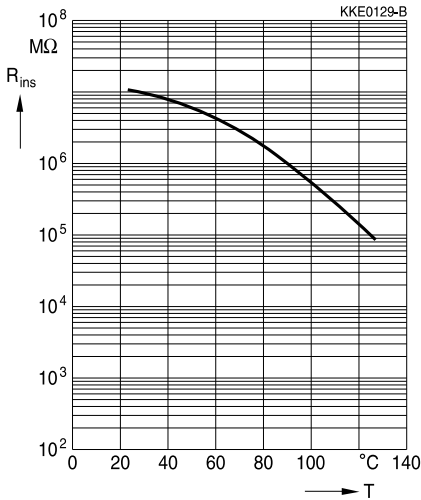

Dissipation factor $\tan \delta$ versus temperature T

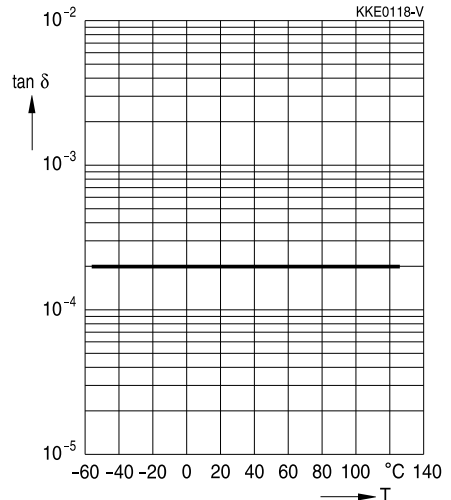

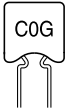

Typical characteristics

Impedance $|Z|$ versus frequency f

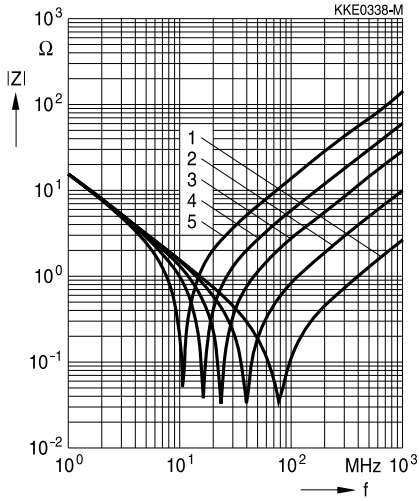

- 1: SMD chip capacitor
- 2: 1.5 mm lead length
- 3: 5.0 mm lead length
- 4: 10.0 mm lead length
- 5: 20.0 mm lead length

Capacitance change $\Delta C/C_1$ versus time t

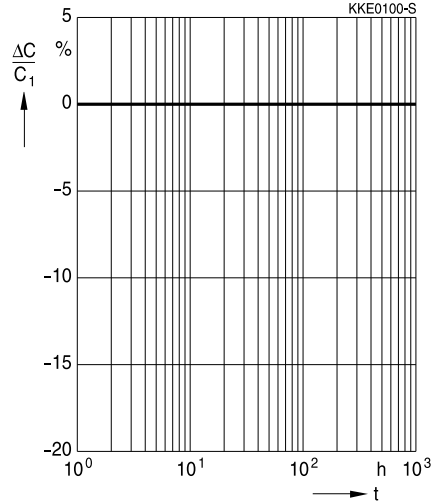

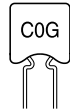

Cautions and warnings

How to select ceramic capacitors

Remember the following when selecting ceramic capacitors:

1. Ceramic capacitors that must fulfill high quality requirements must be qualified based on AEC-Q200 Rev-C.
2. When ceramic capacitors are used at the connection to a battery or power supply (e.g. clamp 15 or 30 in an automobile) or for safety-relevant applications, two single ceramic capacitors should be connected in series. Alternatively a ceramic capacitor with integrated series circuits should be used in order to reduce the possibility of a short circuit caused by a fracture. The MLSC from EPCOS contains such a series circuit in a single component.
3. The use of multilayer varistors (MLVs) is recommended for ESD protection (see chapter "Effects on mechanical, thermal and electrical stress", section 1.4).
4. Additional stress factors such as continuous operating voltage or application-specific derating must be taken into account in the selection of components (refer to chapter "Reliability").

Recommendations for the circuit board design

1. Components with an optimized geometrical design are preferable where permitted by the application.
2. Use at least FR4 circuit board material.
3. Geometrically optimized circuit boards are preferable, especially those that cannot be deformed.
4. Ceramic capacitors should be placed with a sufficient minimum distance from the edge of a circuit board. High bending forces may be exerted there when boards are separated and during further processing of a board (e.g. when incorporating it in a housing).
5. Ceramic capacitors should always be placed parallel to the possible bending axis of a circuit board.
6. Screw connections should not be used to fix a board or connect several boards. Components should not be placed near screw holes. If screw connections are unavoidable, they should be cushioned, for instance using rubber pads.

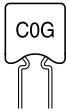

Recommendations for processing

1. Ensure correct positioning of a ceramic capacitor on the solder pad.
2. Be careful when using casting, injection-molded and molding compounds and cleaning agents. They can damage a capacitor.
3. Support a circuit board and reduce placement forces.
4. Do not straighten a board (manually) if it is distorted by soldering.
5. Separate boards with a peripheral saw, or preferably with a milling head (no dicing or breaking).
6. Be careful when subsequently placing heavy or leaded components (e.g. transformers or snap-in components) because of the danger of bending and fracture.
7. When testing, transporting, packing or inserting a board, avoid any deformation of it so that components are not damaged.
8. Avoid excessive force when plugging a connector into a device soldered onto a board.
9. Only mount ceramic capacitors using the soldering process (reflow or wave) that is permissible for them (see chapter "Soldering directions").
10. When soldering, select the softest solder profile possible (heating time, peak temperature, cooling time) to avoid thermal stress and damage.
11. Ensure the correct solder meniscus height and solder quantity.
12. Ensure correct dosing of the cement.
13. Ceramic capacitors with external silver-palladium terminations are intended for conductive adhesion - they are not suited for lead-free soldering processes.

This listing does not claim to be complete, but merely reflects the experience of EPCOS AG.

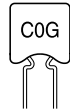
Symbols and terms

Symbol	English	German
A	Area	Fläche
C	Capacitance	Kapazität
C ₀	Initial (original) capacitance	Anfangskapazität
C ₁	Capacitance value after one hour's use	Kapazitätswert nach einer Stunde
C _R	Rated capacitance	Nennkapazität
C ₂₀	Capacitance at 20 °C	Kapazität bei 20 °C
C ₂₅	Capacitance at 25 °C	Kapazität bei 25 °C
ΔC	Capacitance change	Kapazitätsänderung
D	Bending displacement	Durchbiegung
E _a	Activation energy	Aktivierungsenergie
ESR	Equivalent series resistance	Ersatzserienwiderstand
F	Force	Kraft
f	Frequency	Frequenz
f _{meas}	Measuring frequency	Messfrequenz
f _{res}	Self-resonant frequency	Eigenresonanzfrequenz
I _{test}	Test current	Prüfstrom
k	Ageing constant	Alterungskonstante
L	Inductance	Induktivität
N	Quantity (integer values)	Anzahl (ganzzahliger Wert)
P _{loss}	Power dissipation or loss	Verlustleistung
Q _{el}	Electrical charge	Elektrische Ladung
Q	Quality	Güte
R _{ins}	Insulation resistance	Isolationswiderstand
R _p	Parallel resistance	Parallelwiderstand
R _s	Series resistance (circuit resistance)	Serienwiderstand
S _v	Rate of rise of a voltage pulse	Flankensteilheit eines Spannungsimpulses
T	Temperature	Temperatur
T _{meas}	Measuring temperature	Messtemperatur
T _{op}	Operating temperature	Betriebstemperatur
T _{ref}	Reference temperature	Bezugstemperatur
T _{test}	Test temperature	Prüftemperatur
t	Time	Zeit
t _r	Rise time of a voltage pulse	Anstiegszeit eines Spannungsimpulses
t _{test}	Test duration	Prüfdauer
tan δ	Dissipation factor	Verlustfaktor

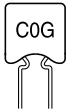
Multilayer ceramic capacitors
COG

Symbol	English	German
V	Voltage	Spannung
V ₀	Initial (original) voltage (basic voltage level)	Anfangsspannung (Spannungsgrundpegel)
V _{meas}	Measuring voltage	Messspannung
V _R	Rated voltage	Nennspannung
V _S	Amplitude of a voltage pulse	Hub des Spannungsimpulses
V _{RMS}	Measuring (root-mean-square or effective) AC voltage	Effektivspannung
V _{test}	Test voltage	Prüfspannung
Z	Magnitude of impedance (AC resistance)	Betrag der Impedanz (Wechselstromwiderstand)
α	Temperature coefficient	Temperaturkoeffizient
ε ₀	Absolute dielectric constant	Absolute Dielektrizitätskonstante
ε _r	Relative dielectric constant	Relative Dielektrizitätskonstante
λ	Failure rate	Ausfallrate
τ	Time constant	Zeitkonstante

Abbreviations / Notes

Symbol	English	German
$\square e$	Lead spacing (in mm)	Rastermaß (in mm)
SMD	Surface-mounted devices	Oberflächenmontierbares Bauelement
*	To be replaced by a number in ordering codes, type designations etc.	Platzhalter für Zahl im Bestellnummern-code oder für die Typenbezeichnung.
+	To be replaced by a letter.	Platzhalter für einen Buchstaben.
	All dimensions are given in mm.	Alle Maße sind in mm angegeben.
	The commas used in numerical values denote decimal points.	Verwendete Kommas in Zahlenwerten bezeichnen Dezimalpunkte.

Important notes

The following applies to all products named in this publication:

1. Some parts of this publication contain **statements about the suitability of our products for certain areas of application**. These statements are based on our knowledge of typical requirements that are often placed on our products in the areas of application concerned. We nevertheless expressly point out **that such statements cannot be regarded as binding statements about the suitability of our products for a particular customer application**. As a rule, EPCOS is either unfamiliar with individual customer applications or less familiar with them than the customers themselves. For these reasons, it is always ultimately incumbent on the customer to check and decide whether an EPCOS product with the properties described in the product specification is suitable for use in a particular customer application.
2. We also point out that **in individual cases, a malfunction of electronic components or failure before the end of their usual service life cannot be completely ruled out in the current state of the art, even if they are operated as specified**. In customer applications requiring a very high level of operational safety and especially in customer applications in which the malfunction or failure of an electronic component could endanger human life or health (e.g. in accident prevention or lifesaving systems), it must therefore be ensured by means of suitable design of the customer application or other action taken by the customer (e.g. installation of protective circuitry or redundancy) that no injury or damage is sustained by third parties in the event of malfunction or failure of an electronic component.
3. **The warnings, cautions and product-specific notes must be observed.**
4. In order to satisfy certain technical requirements, **some of the products described in this publication may contain substances subject to restrictions in certain jurisdictions (e.g. because they are classed as hazardous)**. Useful information on this will be found in our Material Data Sheets on the Internet (www.epcos.com/material). Should you have any more detailed questions, please contact our sales offices.
5. We constantly strive to improve our products. Consequently, **the products described in this publication may change from time to time**. The same is true of the corresponding product specifications. Please check therefore to what extent product descriptions and specifications contained in this publication are still applicable before or when you place an order. We also **reserve the right to discontinue production and delivery of products**. Consequently, we cannot guarantee that all products named in this publication will always be available. The aforementioned does not apply in the case of individual agreements deviating from the foregoing for customer-specific products.
6. Unless otherwise agreed in individual contracts, **all orders are subject to the current version of the "General Terms of Delivery for Products and Services in the Electrical Industry" published by the German Electrical and Electronics Industry Association (ZVEI)**.
7. The trade names EPCOS, BAOKE, Alu-X, CeraDiode, CSMP, CSSP, CTVS, DSSP, MiniBlue, MKK, MLSC, MotorCap, PCC, PhaseCap, PhaseCube, PhaseMod, SIFERRIT, SIFI, SIKOREL, SilverCap, SIMDAD, SIMID, SineFormer, SIOV, SIP5D, SIP5K, ThermoFuse, WindCap are **trademarks registered or pending** in Europe and in other countries. Further information will be found on the Internet at www.epcos.com/trademarks.