



Inductors

RF chokes, LBC series

Series/Type: **B82144A**
Date: **March 2008**

LBC choke (Large Bobbin Core)
Rated inductance 1 μ H to 100 000 μ H
Rated current 20 mA to 2200 mA

Construction

- Large ferrite drum core
- Winding: enamel copper wire
- Flame-retardant lacquer coating

Features

- Very wide inductance range
- High rated current
- Suitable for wave soldering
- RoHS-compatible

Applications

- RF blocking and filtering
- Decoupling and interference suppression
- For telecommunications (12- or 16-kHz blocking filter), automotive electronics, energy-saving lamps, entertainment electronics

Terminals

- Central axial leads
- Base material CuAg0.1
- Hot-dipped with pure tin

Marking

Inductance indicated by color bands to IEC 60062

Delivery mode and packing units

- Taped, Ammo and reel packing
- Packing units:

	Ammo (pcs./pack.)	Reel (pcs./reel)
Axial	1250	1500

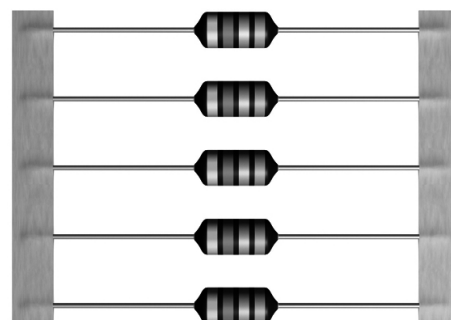

Dimensional drawing

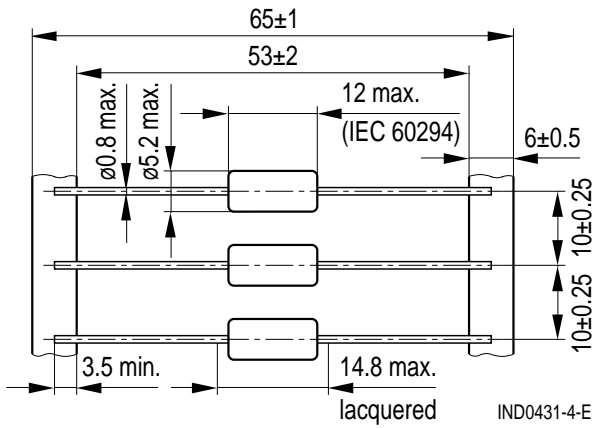

Dimensions in mm
Minimum lead spacing 15 mm

Packing

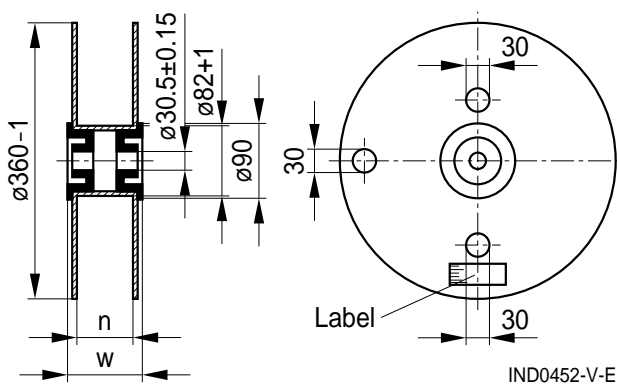

n (mm): 72 +1
w (mm): 84 max

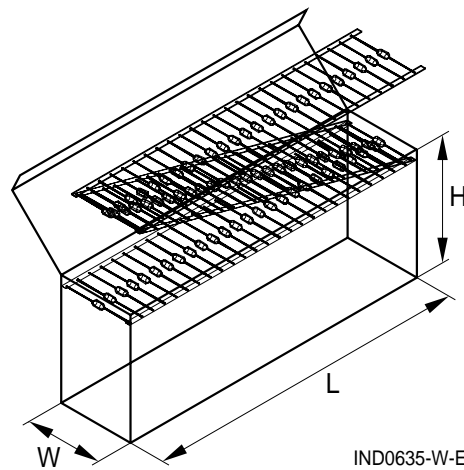

L × W × H (max. mm): 265 × 75 × 125

Dimensions in mm

Technical data and measuring conditions

Rated inductance L_R	Measured with LCR meter Agilent 4284A or impedance analyzer Agilent 4294A Measuring frequency: $L_R \leq 10 \mu\text{H}$ = 1 MHz $10 \mu\text{H} < L_R \leq 4700 \mu\text{H}$ = 100 kHz $L_R > 4700 \mu\text{H}$ = 10 kHz Measuring current: $\leq 1 \text{ mA}$ Measuring temperature: 20 °C
Q factor Q_{\min}	Measured with precision impedance analyzer Agilent 4294A, 20 °C
Rated temperature T_R	40 °C
Rated current I_R	Maximum permissible DC current at rated temperature
Inductance decrease $\Delta L/L_0$	$\leq 10\%$ (referred to initial value) at I_R , 20 °C
DC resistance R_{\max}	Measured at 20 °C
Resonance frequency $f_{\text{res},\min}$	Measured with Agilent 4294A or 8753ES, 20 °C
Solderability (lead-free)	Sn95.5Ag3.8Cu0.7: (245 ±5) °C, (3 ±0.3) s Wetting of soldering area $\geq 90\%$ (to IEC 60068-2-20, test Ta)
Resistance to soldering heat	(260 ±5) °C, 10 s (to IEC 60068-2-20, test Tb)
Tensile strength of leads	$\geq 20 \text{ N}$ (to IEC 60068-2-21, test Ua)
Climatic category	55/125/56 (to IEC 60068-1)
Storage conditions	Mounted: -55 °C ... +125 °C Packaged: -25 °C ... +40 °C, $\leq 75\%$ RH
Weight	Approx. 1.1 g

 Mounting information

When bending the leads, take care that the start-of-winding areas at the face ends (protected by glue and lacquer) are not subjected to any mechanical stress.

Characteristics and ordering codes

L_R μH	Tolerance ¹⁾	Q_{\min}	f_Q MHz	I_R mA	R_{\max} Ω	$f_{\text{res,min}}$ MHz	Ordering code (reel packing) ²⁾
1.0	$\pm 10\% \triangleq K$	40	7.96	2200	0.08	200	B82144A2102K000
1.5		40	7.96	2100	0.09	190	B82144A2152K000
2.2		40	7.96	1900	0.11	140	B82144A2222K000
3.3		40	7.96	1750	0.13	120	B82144A2332K000
4.7		40	7.96	1600	0.16	100	B82144A2472K000
6.8		40	7.96	1500	0.19	80	B82144A2682K000
10		60	2.52	1400	0.22	60	B82144A2103K000
15		60	2.52	1250	0.28	20	B82144A2153K000
22		50	2.52	1100	0.35	12	B82144A2223K000
33		$\pm 5\% \triangleq J$	40	2.52	900	0.43	8.0
47	40		2.52	800	0.50	5.0	B82144A2473J000
68	30		2.52	700	0.60	4.5	B82144A2683J000
100	50		0.796	600	0.70	3.5	B82144A2104J000
150	50		0.796	500	0.90	3.0	B82144A2154J000
220	50		0.796	400	1.60	2.4	B82144A2224J000
330	50		0.796	330	1.90	2.0	B82144A2334J000
470	40		0.796	280	2.50	1.5	B82144A2474J000
680	30		0.796	240	2.80	1.3	B82144A2684J000
1000	60		0.252	200	3.80	1.2	B82144A2105J000
1500	60	0.252	160	6.00	1.0	B82144A2155J000	
2200	60	0.252	120	9.00	0.8	B82144A2225J000	
3300	60	0.252	110	12.0	0.6	B82144A2335J000	
4700	60	0.252	90	20.0	0.5	B82144A2475J000	
6800	60	0.252	80	30.0	0.4	B82144A2685J000	
10000	50	0.0796	60	42.0	0.35	B82144A2106J000	
15000	50	0.0796	50	68.0	0.30	B82144A2156J000	
22000	50	0.0796	40	120	0.26	B82144A2226J000	
33000	50	0.0796	35	150	0.22	B82144A2336J000	
47000	40	0.0796	30	230	0.18	B82144A2476J000	
68000	40	0.0796	25	290	0.15	B82144A2686J000	
100000	30	0.0796	20	420	0.12	B82144A2107J000	

1) Closer tolerances on request.

2) For Ammo pack the last digit has to be a »9«. Example: B82144A2102K009

Characteristics and ordering codes

L_R μH	Tolerance	Q_{\min}	f_Q MHz	I_R mA	R_{\max} Ω	$f_{\text{res,min}}$ MHz	Ordering code (reel packing) ¹⁾
------------------------	-----------	------------	--------------	-------------	------------------------	-----------------------------	---

For telecommunications in the blocking filter for 12-kHz and 16-kHz counting pulses

980	$\pm 3\% \triangleq A$	25	0.016	200	3.8	1.2	B82144A2984A000
1450		25	0.016	140	6.0	1.0	B82144A2145A500
2600		20	0.012	120	11.0	0.7	B82144A2265A000
3050		25	0.016	100	12.0	0.6	B82144A2305A500
5330		20	0.012	90	25.0	0.5	B82144A2535A300

1) For Ammo pack the last digit has to be a »9«. Example: B82144A2336J009

Impedance |Z| versus frequency f
 measured with impedance analyzer Agilent 4294A or S-parameter network analyzer Agilent 8753ES, typical values at 20 °C

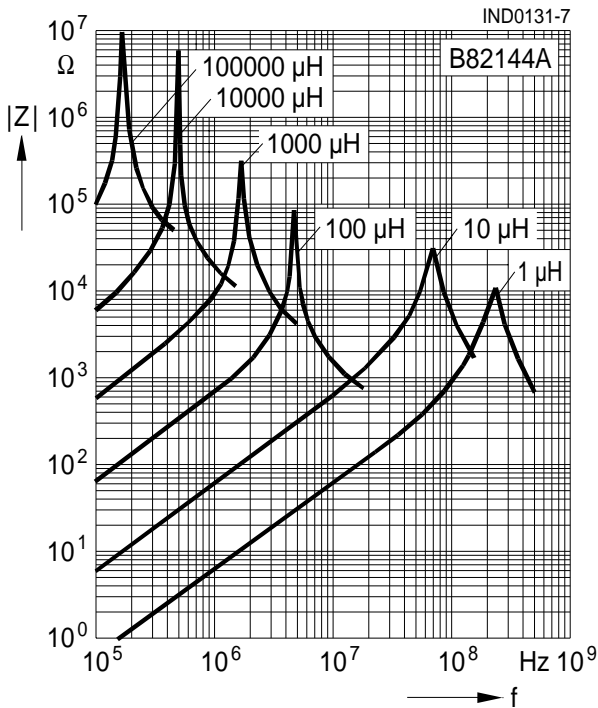

Inductance L versus DC load current I_{DC}
 measured with LCR meter Agilent 4284A, typical values at 20 °C

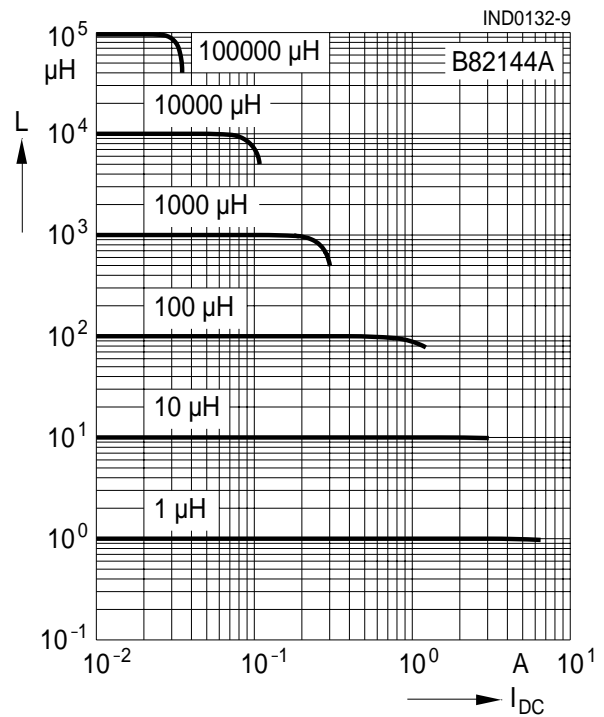

Q factor versus frequency f
 measured with impedance analyzer Agilent 4294A, typical values at 20 °C

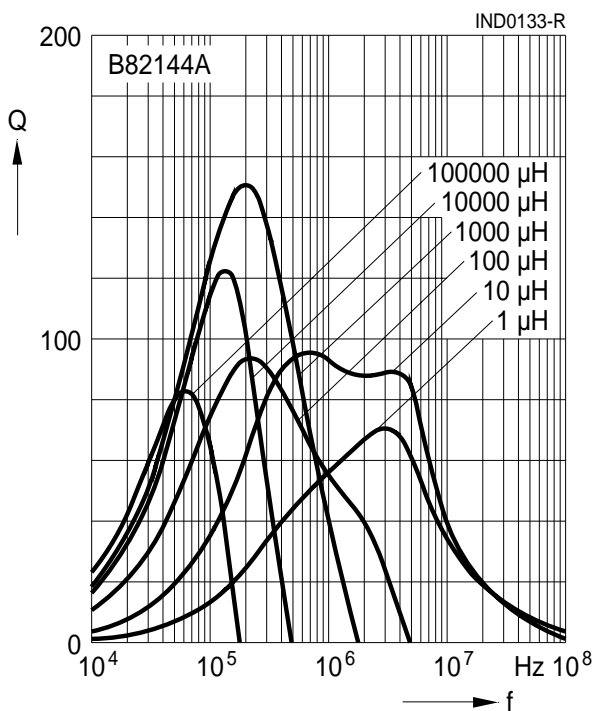

Current derating I_{op}/I_R versus ambient temperature T_A
 (rated temperature T_R = 40 °C)

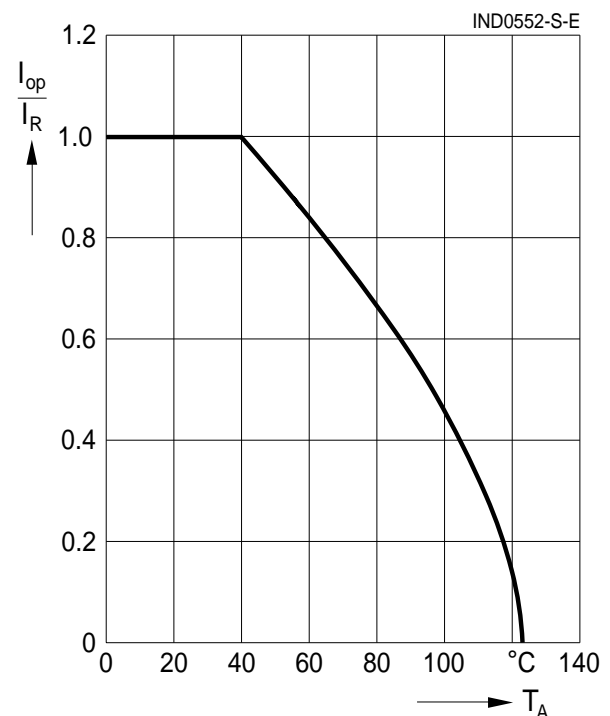

Cautions and warnings

- Please note the recommendations in our Inductors data book (latest edition) and in the data sheets.
 - Particular attention should be paid to the derating curves given there.
 - The soldering conditions should also be observed. Temperatures quoted in relation to wave soldering refer to the pin, not the housing.
- If the components are to be washed varnished it is necessary to check whether the washing varnish agent that is used has a negative effect on the wire insulation, any plastics that are used, or on glued joints. In particular, it is possible for washing varnish agent residues to have a negative effect in the long-term on wire insulation.
- The following points must be observed if the components are potted in customer applications:
 - Many potting materials shrink as they harden. They therefore exert a pressure on the plastic housing or core. This pressure can have a deleterious effect on electrical properties, and in extreme cases can damage the core or plastic housing mechanically.
 - It is necessary to check whether the potting material used attacks or destroys the wire insulation, plastics or glue.
 - The effect of the potting material can change the high-frequency behaviour of the components.
- Ferrites are sensitive to direct impact. This can cause the core material to flake, or lead to breakage of the core.
- Even for customer-specific products, conclusive validation of the component in the circuit can only be carried out by the customer.

Important notes

The following applies to all products named in this publication:

1. Some parts of this publication contain **statements about the suitability of our products for certain areas of application**. These statements are based on our knowledge of typical requirements that are often placed on our products in the areas of application concerned. We nevertheless expressly point out **that such statements cannot be regarded as binding statements about the suitability of our products for a particular customer application**.

As a rule, EPCOS is either unfamiliar with individual customer applications or less familiar with them than the customers themselves. For these reasons, it is always ultimately incumbent on the customer to check and decide whether an EPCOS product with the properties described in the product specification is suitable for use in a particular customer application.

2. We also point out that **in individual cases, a malfunction of electronic components or failure before the end of their usual service life cannot be completely ruled out in the current state of the art, even if they are operated as specified**. In customer applications requiring a very high level of operational safety and especially in customer applications in which the malfunction or failure of an electronic component could endanger human life or health (e.g. in accident prevention or life-saving systems), it must therefore be ensured by means of suitable design of the customer application or other action taken by the customer (e.g. installation of protective circuitry or redundancy) that no injury or damage is sustained by third parties in the event of malfunction or failure of an electronic component.
3. **The warnings, cautions and product-specific notes must be observed.**
4. In order to satisfy certain technical requirements, **some of the products described in this publication may contain substances subject to restrictions in certain jurisdictions (e.g. because they are classed as hazardous)**. Useful information on this will be found in our Material Data Sheets on the Internet (www.epcos.com/material). Should you have any more detailed questions, please contact our sales offices.
5. We constantly strive to improve our products. Consequently, **the products described in this publication may change from time to time**. The same is true of the corresponding product specifications. Please check therefore to what extent product descriptions and specifications contained in this publication are still applicable before or when you place an order.

We also **reserve the right to discontinue production and delivery of products**. Consequently, we cannot guarantee that all products named in this publication will always be available.

The aforementioned does not apply in the case of individual agreements deviating from the foregoing for customer-specific products.

6. Unless otherwise agreed in individual contracts, **all orders are subject to the current version of the “General Terms of Delivery for Products and Services in the Electrical Industry” published by the German Electrical and Electronics Industry Association (ZVEI)**.
7. The trade names EPCOS, BAOKE, Alu-X, CeraDiode, CSMP, CSSP, CTVS, DSSP, MiniBlue, MKK, MLSC, MotorCap, PCC, PhaseCap, PhaseCube, PhaseMod, SIFERRIT, SIFI, SIKOREL, SilverCap, SIMDAD, SIMID, SineFormer, SIOV, SIP5D, SIP5K, ThermoFuse, WindCap are **trademarks registered or pending** in Europe and in other countries. Further information will be found on the Internet at www.epcos.com/trademarks.