

Data sheet | Item number: 286-316

Relay module; Nominal input voltage: 220 VDC; 2 changeover contacts;
Limiting continuous current: 7 A; Red status indicator; Module width: 20 mm

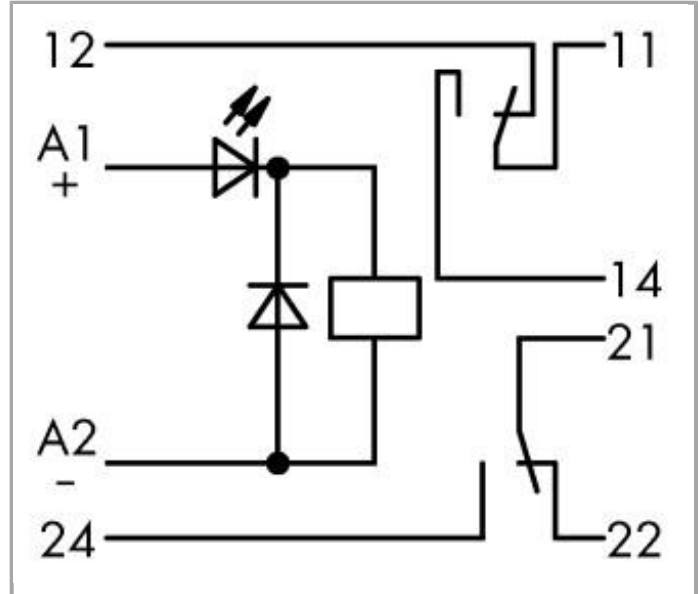

www.wago.com/286-316



RoHS Compliant

[BOMcheck.net](https://www.bomcheck.net)

Color: ■

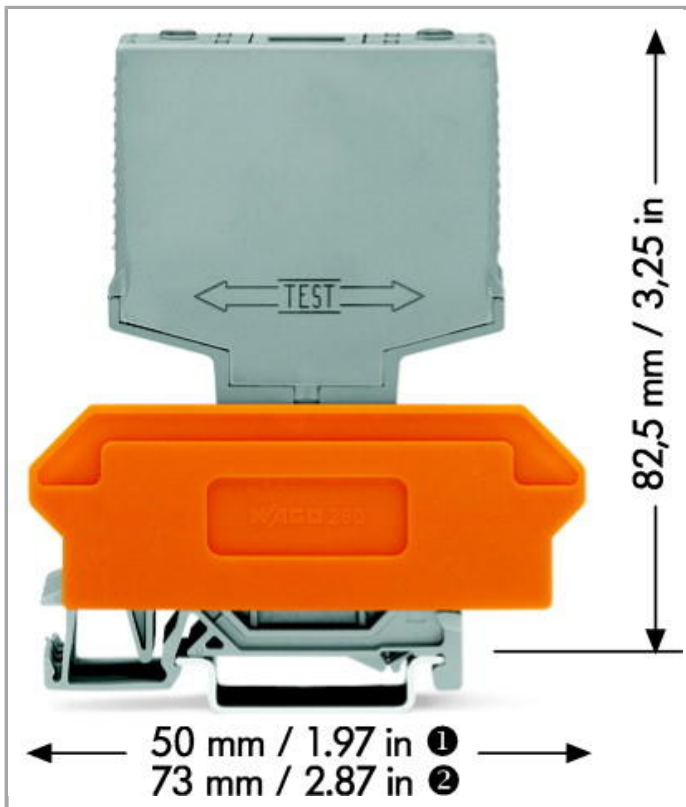

Data

Technical Data

Control circuit

Nominal input voltage U_N	220 VDC
Nominal input current at U_N	5 mA

Load circuit:

Number of changeover/switchover contacts	2
Contact material (relay)	AgNi 0.15
Limiting continuous current	7 A
Max. switching voltage	250 VAC
Max. switching power (resistive)	1750 VAAC
Pull-in time (typ.)	18 ms
Drop-out time (typ.)	3 ms
Bounce time (typ.)	2 ms
Electrical life (N.O.; resistive load; 23 °C)	250 x 10 ³ switching operations
Mechanical life (N.O.; resistive load; 23 °C)	300 x 10 ⁶ switching operations

Signaling

Status indication	LED red
-------------------	---------

Safety and protection:

Rated voltage	250 V
Rated impulse voltage	4 kV
Pollution degree	2
Dielectric strength, control/load circuit (AC, 1 min)	2 kV _{rms}
Dielectric strength, control/load circuit (AC, 1 min)	2 kV _{rms}
Dielectric strength open contact (AC, 1 min)	1 kV _{rms}
Dielectric strength open contact (AC, 1 min)	1 kV _{rms}
Dielectric strength, load/load circuit (AC, 1 min)	1.5 kV _{rms}
Dielectric strength, load/load circuit (AC, 1 min)	1.5 kV _{rms}
Degree of protection	IP20

Geometrical Data

Width	20 mm / 0.787 inch
Height from upper-edge of DIN-35 rail	82.5 mm / 3.248 inch
Depth	52 mm / 1.654 inch

Mechanical data

Type of mounting	Pluggable module for carrier terminal blocks
------------------	--

Material Data

Color	gray
Fire load	0.589 MJ
Weight	39.9 g

Environmental Requirements

Surrounding air (operating) temperature at U _N	-25 ... 40 °C
Pollution degree	2

Standards and specifications



Standards/specifications	EN 60664-1
--------------------------	------------

Commercial data









Country of origin	DE
GTIN	4045454553630
Customs Tariff No.	85364900990
Product Group	6 (Interface Electronics)

Compatible products

General accessories

	Item no.: 280-628 Terminal block for pluggable modules; 16-pole; with 4-conductor terminal blocks; with orange separator; for DIN-rail 35 x 15 and 35 x 7.5; 2.5 mm ²	www.wago.com/280-628
	Item no.: 280-638 Terminal block for pluggable modules; 8-pole; with 2-conductor terminal blocks; with orange separator; for DIN-rail 35 x 15 and 35 x 7.5; 2.5 mm ²	www.wago.com/280-638
	Item no.: 280-764 Terminal block for pluggable modules; 16-pole; with 4-conductor terminal blocks; with marker carrier; with orange separator; for DIN-rail 35 x 15 and 35 x 7.5; 2.5 mm ²	www.wago.com/280-764

Marking accessories

	Item no.: 209-701 WSB marking card; as card; not stretchable; plain; snap-on type	www.wago.com/209-701
	Item no.: 209-701/000-002 WSB marking card; as card; not stretchable; plain; snap-on type	www.wago.com/209-701/000-002
	Item no.: 209-701/000-005 WSB marking card; as card; not stretchable; plain; snap-on type	www.wago.com/209-701/000-005
	Item no.: 209-701/000-006 WSB marking card; as card; not stretchable; plain; snap-on type	www.wago.com/209-701/000-006
	Item no.: 209-701/000-007 WSB marking card; as card; not stretchable; plain; snap-on type	www.wago.com/209-701/000-007
	Item no.: 209-701/000-012 WSB marking card; as card; not stretchable; plain; snap-on type	www.wago.com/209-701/000-012
	Item no.: 209-701/000-017 WSB marking card; as card; not stretchable; plain; snap-on type	www.wago.com/209-701/000-017
	Item no.: 209-701/000-023 WSB marking card; as card; not stretchable; plain; snap-on type	www.wago.com/209-701/000-023
	Item no.: 209-701/000-024 WSB marking card; as card; not stretchable; plain; snap-on type	www.wago.com/209-701/000-024



Downloads

Documentation

Bid Text

286-316 Relaisbaustein	Jan 22, 2016	DOC 27.1 kB	Download
---------------------------	--------------	----------------	----------

Additional Information

Disposal; Electrical and electronic equipment, Packaging	Oct 15, 2018	265.8 kB	Download
--	--------------	----------	----------

smartDATA

CAD data

3D Download 286-316		URL	Download
---------------------	--	-----	----------

Subject to changes.