

Monitoring relays and float switch

72
SERIES



Industrial washing machines



Swimming pools



Control and management of water



Bottling plant



Milk processing plant



Control panels for pumps



Level control relays for conductive liquids

Type 72.01

- Adjustable sensitivity
- Available also for supply 400 V
- Available also with sensitivity range (5...450)kΩ adjustable
- Available also for contact loads down to 5 V, 1 mA

Type 72.11

- Fixed sensitivity
- Emptying or filling functions
- LED indicator
- Reinforced insulation (6 kV - 1.2/50 μs) between:
 - supply and contacts
 - electrodes and supply
 - contacts and electrodes
- 35 mm rail (EN 60715) mount
- Control about a single level or between Min./Max. limits

72.01/11
Screw terminal



FOR UL RATINGS SEE:
"General technical information" page V

For outline drawing see page 10

Contact specification

Contact configuration		1 CO (SPDT)
Rated current/Maximum peak current	A	16/30
Rated voltage/ Maximum switching voltage	V AC	250/400
Rated load AC1	VA	4000
Rated load AC15 (230 V AC)	VA	750
Single phase motor rating (230 V AC)	kW	0.55
Breaking capacity DC1: 24/110/220 V	A	16/0.3/0.12
Minimum switching load	mW (V/mA)	500 (10/5)
Standard contact material		AgNi

Supply specification

Nominal voltage (U _N)	V AC (50/60 Hz)	24	110...125	230...240	400
	V DC	24	—	—	—
Rated power AC/DC	VA (50 Hz)/W	2.5/1.5			
Operating range	V AC (50/60 Hz)	19.2...26.4	90...130	184...253	360...460
	V DC	20.4...26.4	—	—	—

Technical data

Electrical life at rated load AC1	cycles	100 · 10 ³
Electrode voltage	V AC	4
Electrode current	mA	0.2
Run-on time	s	0.5 - 7 (selectable)
Max sensitivity range	kΩ	5...150 (adjustable)
Insulation between supply/contacts/electrode (1.2/50 μs)	kV	6
Ambient temperature	°C	-20...+60
Protection category		IP 20

Approvals (according to type)

72.01



- Sensitivity range (5...150)kΩ adjustable
- Delay time (0.5 s or 7 s) switch selectable
- Emptying or filling functions switch selectable

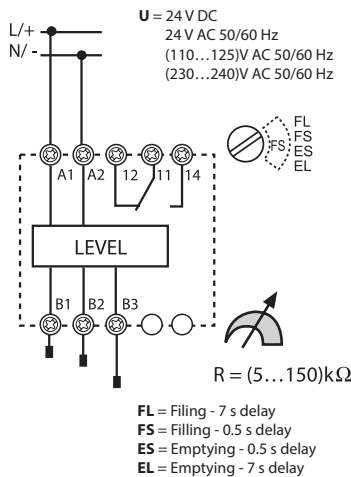

72.11



- Sensitivity fixed 150 kΩ
- Delay time fixed: 1 s
- Emptying or filling functions link selectable

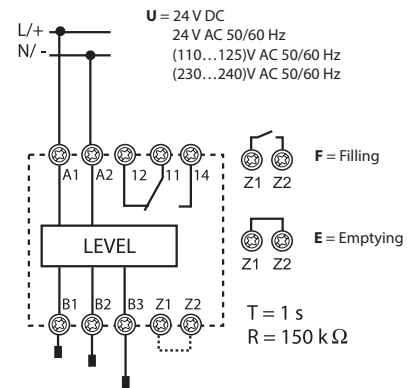

Special relay for alternating loads, for applications with pumps, compressors, air conditioning or refrigeration units

Type 72.42

- Priority change relay
- 2 independent NO output, 12 A
- 4 functions
- 2 independent control signals, insulated from supply
- 110...240 V and 24 V AC/DC supply versions
- Modular housing, 35 mm wide
- 35 mm rail (EN 60715) mount
- Cd-free contact material

72.42
Screw terminal



E

72.42



- Multi-function (M1, ME, M2, M1)

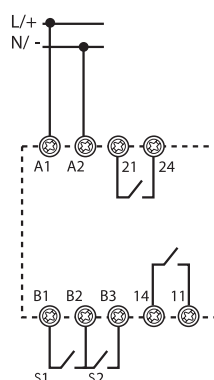

For outline drawing see page 10

Contact specification

Contact configuration	2 NO (2 DPST-NO)	
Rated current/Max. peak current	A	12/20
Rated voltage/ Max. switching voltage	V AC	250/400
Rated load AC1	VA	3000
Rated load AC15	VA	1000
Single phase motor rating (230 V AC)	kW	0.55
Breaking capacity DC1: 24/110/220 V	A	12/0.3/0.12
Minimum switching load	mW (V/mA)	300 (5/5)
Standard contact material	AgNi	

Supply specification

Nominal voltage (U _N)	V AC (50/60 Hz) / DC	24	110...240
Rated power	in stand-by W	0.12	0.18
	with 2 active relays W/VA(50 Hz)	1.1/1.7	1.5/3.9
Operating range	V AC (50/60 Hz)	16.8...28.8	90...264
	V DC	16.8...32	90...264

Technical data

Electrical life at rated load AC1	cycles	100 · 10 ³
Output delay time (T on function diagrams)	s	0.2...20
Power-on activation time	s	≤ 0.7
Minimum impulse duration	ms	50
Insulation between supply and contacts (1.2/50 μs)	kV	6
Dielectric strength between open contacts	V AC	1000
Ambient temperature	°C	-20...+50
Protection category	IP 20	

Approvals (according to type)



Ordering information

Example: 72 series level control relay, adjustable sensitivity range, (230...240)V AC supply voltage.

72.01.8.240.0000

Series

Type

- 0 = Level control relay, sensitivity range adjustable (5...150)kΩ
- 1 = Level control relay, sensitivity fixed 150 kΩ
- 4 = Priority change relay

No. of poles

- 1 = 1 CO (SPDT)
- 2 = 2 NO (DPST-NO)

Contact material

- 0 = AgNi
- 5 = AgNi + Au**

Supply voltage

- 024 = 24 V
- 125 = (110...125)V AC
- 230 = (110 ... 240)V
- 240 = (230...240)V AC
- 400 = 400 V AC (72.01 only)

Supply version

- 0 = DC/AC (50/60 Hz)
- 8 = AC (50/60 Hz)
- 9 = DC

All versions

- 72.01.8.024.0000
- 72.01.8.024.0002*
- 72.01.8.125.0000
- 72.01.8.240.0000
- 72.01.8.240.0002*
- 72.01.8.240.5002**
- 72.01.8.400.0000
- 72.01.9.024.0000
- 72.11.8.024.0000
- 72.11.8.125.0000
- 72.11.8.240.0000
- 72.11.9.024.0000
- 72.42.0.230.0000
- 72.42.0.024.0000

Option

- 0 = Max. 150 kΩ
- 2 = Sensitivity range adjustable (5...450)kΩ types
- 72.01.8.024.0002*
- 72.01.8.240.0002*
- 72.01.8.240.5002**

* For liquids conductivity up to 2 μ Siemens or a Resistance of 450 kΩ

** For applications with output contact loading down to 5 V, 1 mA



Technical data

Insulation			72.01/72.11	72.42
Insulation		Dielectric strength	Impulse (1.2/50 µs)	
		between supply and contacts	4000 V AC	6 kV
		between supply and control (for 110...240 V version only)	2500 V AC	—
		between electrodes, Z1-Z2 and supply*	4000 V AC	6 kV
		between contacts and electrodes	4000 V AC	6 kV
	between open contacts	1000 V AC	1.5 kV	1.5 kV
EMC specifications				
Type of test		Reference standard	72.01/72.11	72.42
Electrostatic discharge	contact discharge	EN 61000-4-2	4 kV	4 kV
	air discharge	EN 61000-4-2	8 kV	8 kV
Radio-frequency electromagnetic field	(80...1000 MHz)	EN 61000-4-3	10 V/m	10 V/m
	(1...2.8 GHz)	EN 61000-4-3	—	5 V/m
Fast transients (burst 5/50 ns, 5 and 100 kHz)	on supply terminals	EN 61000-4-4	4 kV	4 kV
	on control terminals	EN 61000-4-4	—	4 kV
Voltage pulses on supply terminals (surge 1.2/50 µs)	common mode	EN 61000-4-5	4 kV	4 kV
	differential mode	EN 61000-4-5	4 kV	4 kV
Radiofrequency common mode voltage (0.15...280 MHz)	on supply terminals	EN 61000-4-6	10 V	10 V (0.15...230 MHz)
	on control terminals	EN 61000-4-6	—	10 V
Voltage dips	70% U _N	EN 61000-4-11	—	25 cycles
Short interruptions		EN 61000-4-11	—	1 cycles
Radiofrequency conducted emissions	(0.15...30 MHz)	CISPR 11	class B	class B
Radiated emissions	(30...1000 MHz)	CISPR 11	class B	class B
Terminals				
 Screw torque	Nm	0.8		
Wire strip length	mm	9		
Max. wire size		solid cable	stranded cable	
	mm ²	1 x 6 / 2 x 4	1 x 4 / 2 x 2.5	
	AWG	1 x 10 / 2 x 12	1 x 12 / 2 x 14	
Other data				
Current absorption on Z1 and Z2 (type 72.11)	mA	< 1		
Current absorption on control signal (B1-B2 and B2-B3) - (type 72.42)		5 mA, 5 V		
Power lost to the environment		72.01/72.11	72.42	
	without contact current	W	1.5	0.9 (1 relay ON)
	with rated current	W	3.2	3.0 (2 relays ON)
Max cable length between electrode and relay (types 72.01/72.11)	m	200 (max. capacitance of 100 nF/km)		

* There is no electrical isolation between electrodes and supply voltage for the 24 V DC types (72.x1.9.024.0000). Therefore, for SELV applications it would be necessary to use a SELV (non-grounded) power supply. In the case of a PELV (grounded) power supply take care to protect the level control relay against harmful circulating currents by ensuring that no electrodes are grounded.

However, there is no such problem for the 24 V AC types (72.x1.8.024.0000) which, by virtue of an internal isolating transformer, assure reinforced isolation between electrodes and supply.

Functions for 72.01 and 72.11

- U** = Supply voltage
- B1** = Max level electrode
- B2** = Min level electrode
- B3** = Common
- = Contact 11-14
- Z1-Z2** = Link to select emptying (Type 72.11)

LED	Supply voltage	NO output contact	Contacts	
			Open	Closed
	OFF	Open	11 - 14	11 - 12
	ON	Open	11 - 14	11 - 12
	ON	Open (Timing in Progress)	11 - 14	11 - 12
	ON	Closed	11 - 12	11 - 14

Function and Run-on time

Type 72.01

- FL** = Level control by Filling, Long (7 s) run-on delay.
- FS** = Level control by Filling, Short (0.5 s) run-on delay.
- ES** = Level control by Emptying, Short (0.5 s) run-on delay.
- EL** = Level control by Emptying, Long (7 s) run-on delay.

Type 72.11

- F** = Level control by Filling, Z1-Z2 open. Run-on time fixed at 1 s.
- E** = Level control by Emptying, Z1-Z2 linked. Run-on time fixed at 1 s.

Filling functions

Wiring diagram

Examples with 3 electrodes

Type 72.01

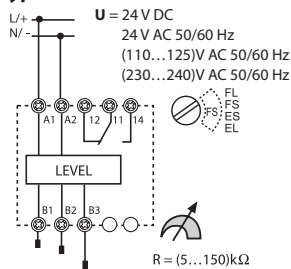

Type 72.11

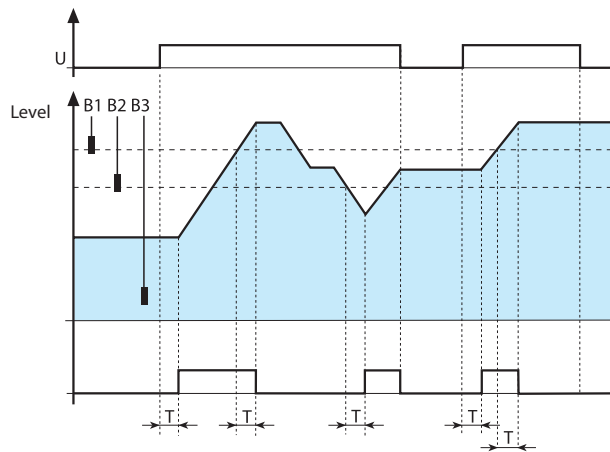
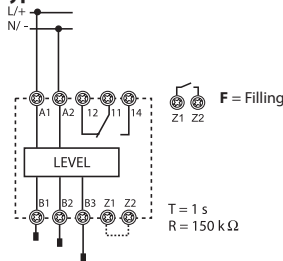

Filling Control – between Min. and Max. levels.

Under normal operation the liquid level can be expected to cycle between the Minimum and the Maximum electrodes, B2 and B1 (plus a degree of over and under-shoot).

Switch On:

- On “power-up”, if the liquid is below B1 the output relay will operate after time T has expired.
- On the liquid level falling below B2, the output relay will operate after time T has expired.

Switch Off:

- On the liquid level reaching electrode B1, the output relay will de-energise after time T has expired.
- On “power-off”, the output relay will immediately de-energise.

Wiring diagram

Examples with 2 electrodes

Type 72.01

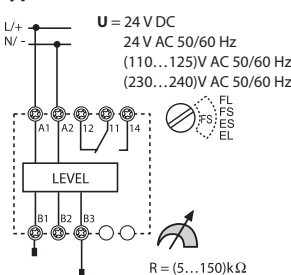

Type 72.11

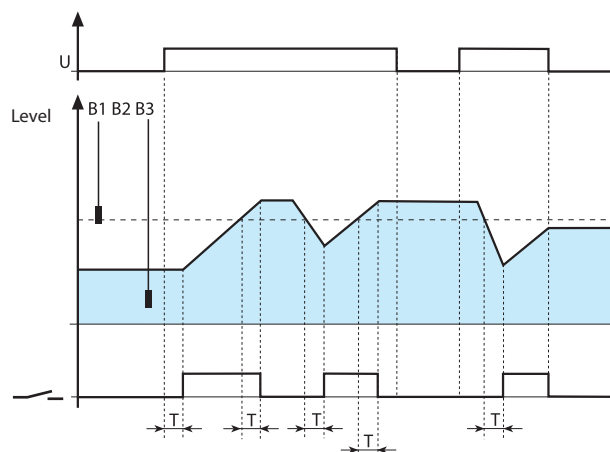
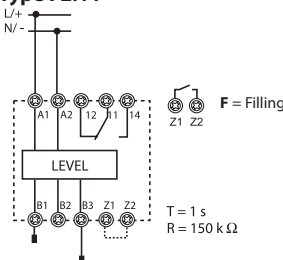

Filling Control – about a single level, B1.

Under normal operation the liquid level can be expected to cycle about the level set by electrode B1 with a degree of over and under-shoot.

Switch On:

- On “power-up”, if the liquid is below B1 the output relay will operate after time T has expired.
- On the liquid level falling below B1, the output relay will operate after time T has expired.

Switch Off:

- On the liquid level reaching electrode B1, the output relay will de-energise after time T has expired.
- On “power-off”, the output relay will immediately de-energise.

Emptying functions

Wiring diagram

Examples with 3 electrodes

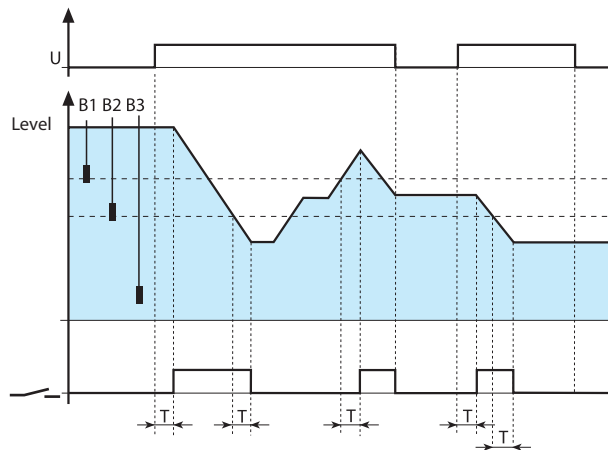
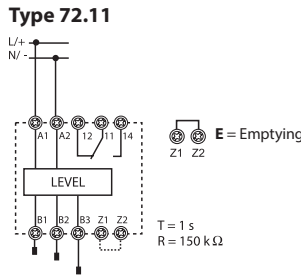
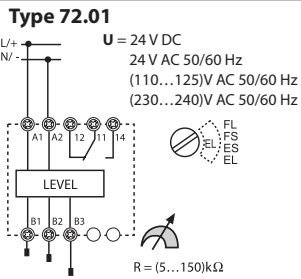

Emptying Control - between Max. and Min. levels.

Under normal operation the liquid level can be expected to cycle between the Maximum and the Minimum electrodes, B1 and B2 (plus a degree of over and under-shoot).

Switch On:

- On "power-up", if the liquid level is above B2 the output relay will operate after time T has expired.
- On the liquid level rising to B1, the output relay will operate after time T has expired.

Switch Off:

- On the liquid level falling below electrode B2, the output relay will de-energise after time T has expired.
- On "power-off", the output relay will immediately de-energise.

Wiring diagram

Examples with 2 electrodes

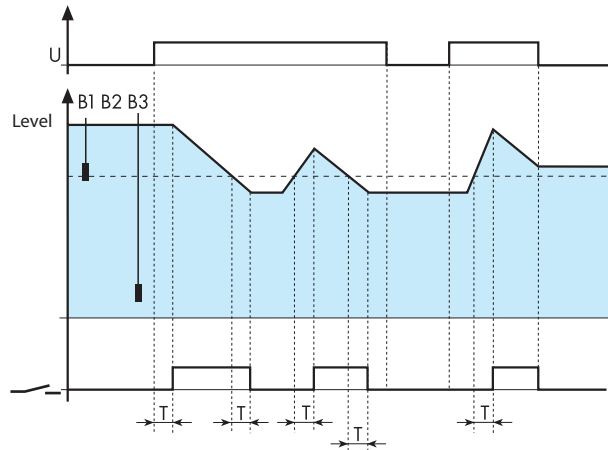
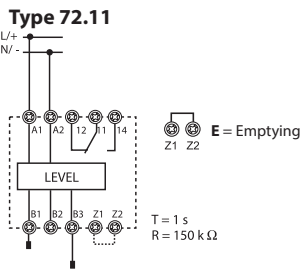
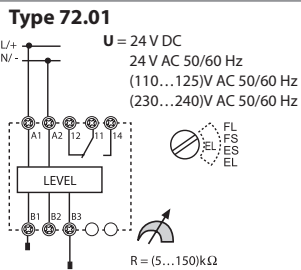

Emptying Control about a single level, B1.

Under normal operation the liquid level can be expected to cycle about the level set by electrode B1 with a degree of over and under-shoot.

Switch On:

- On "power-up", if the liquid is above B1 the output relay will operate after time T has expired.
- On the liquid level rising to B1, the output relay will operate after time T has expired.

Switch Off:

- On the liquid level falling below electrode B1, the output relay will de-energise after time T has expired.
- On "power-off", the output relay will immediately de-energise.

Applications for 72.01 and 72.11

FILLING function:

Examples with 3 electrodes and with a contactor connected to the contact.

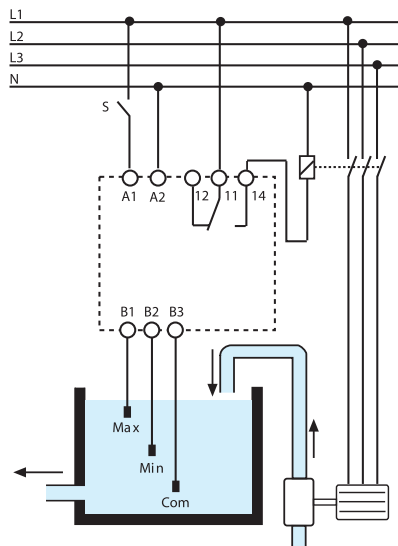

EMPTYING function:

Examples with 3 electrodes and with a motor pump connected directly to the contact.

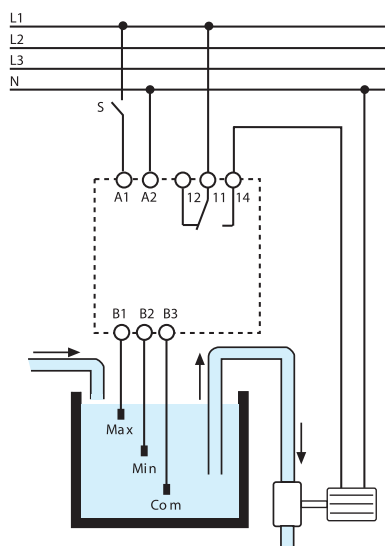

The 72 series level control relays work by measuring the resistance through the liquid, between the common (B3) electrode and Min. and Max. electrodes (B2 and B1). If the tank is metallic, then this can be substituted as the B3 electrode.

Take care to ensure that the liquid has a suitable resistivity – see below:

SUITABLE LIQUIDS

- City water
- Well water
- Rainwater
- Sea water
- Liquids with low-percentage alcohol
- Wine
- Milk, Beer, Coffee
- Sewage
- Liquids fertilizer

UN-SUITABLE LIQUIDS

- Demineralised water
- Fuels
- Oil
- Liquids with high-percentage alcohol
- Liquid gas
- Paraffins
- Ethylene glycol
- Paint

Functions for 72.42

A1-A2 = Supply voltage

S1 (B1-B2) = Control signal 1

S2 (B3-B2) = Control signal 2

= Contact 1 (11-14) and
Contact 2 (21-24)

LED 1 = Output 1

LED 2 = Output 2

LED	
	Device in stand-by, output not activated
	Output not activated, timing in progress
	Output not activated (only functions M1/M2)
	Output activated

Wiring diagram

		<p>(MI) Outputs alternate on successive applications of supply voltage</p> <ul style="list-style-type: none"> Application of the supply voltage to A1-A2 forces just one output contact to close, but the contact that closes will alternate between 11-14 and 21-24 on each successive application of the supply – ensuring even wear across both motors. The other output contact can be forced closed by the closure of either S1 or S2 - but to limit high current surges the other motor cannot start within T seconds of the first motor.
		<p>(ME) Outputs alternate according to control signal</p> <ul style="list-style-type: none"> The supply voltage is permanently applied to A1-A2. When closed, S1 forces just one output contact to close. The contact that closes will alternate between 11-14 and 21-24 on each successive S1 closure - ensuring even wear across both motors. If closed, S2 forces both output contacts to close (irrespective of S1). However, to limit high current surges, both motors cannot start within T seconds of each other.
		<p>(M2) Output 2 (21-24) only</p> <ul style="list-style-type: none"> Supply permanently applied to A1-A2. Closure of either S1 or S2 will close output contact 2 (21-24). Use when load 1 (11-14) is out of service.
		<p>(M1) Output 1 (11-14) only</p> <ul style="list-style-type: none"> Supply permanently applied to A1-A2. Closure of either S1 or S2 will close output contact 1 (11-14). Use when load 2 (21-24) is out of service.

E

MI function example

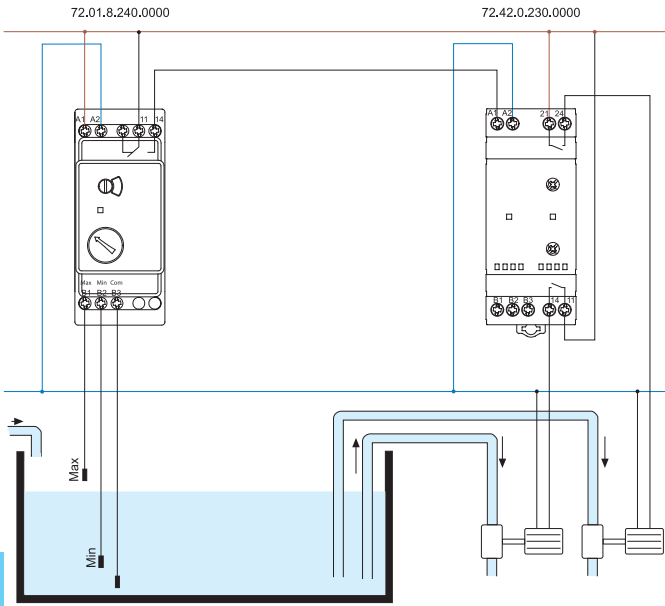

This shows the 72.42 Priority change relay working in conjunction with a single 72.01 level controller. Under normal conditions the liquid level is expected to remain within the range shown as Min to Max. In this case the function of the 72.42 will be to alternate the duty between both pumps, to even wear across both pumps. There is no provision to run both pumps simultaneously.

ME function example

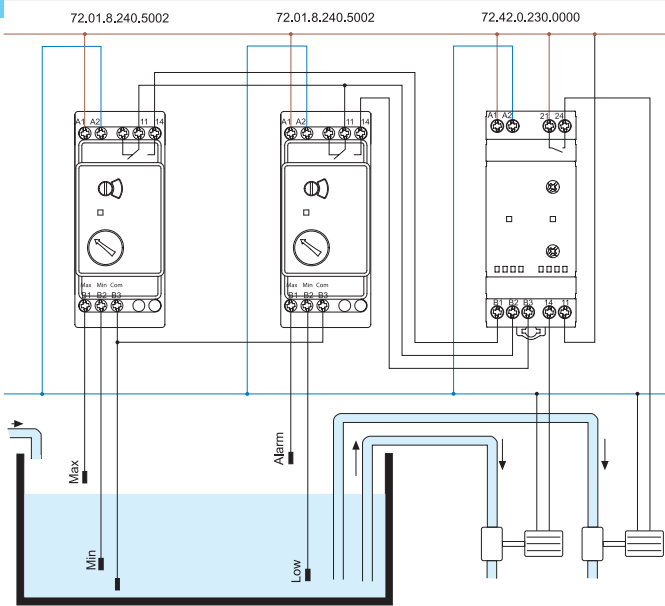

This shows the 72.42 Priority change relay working in conjunction with two 72.01 level controllers. Under normal conditions the liquid level is expected to remain within the range shown as Min to Max. In this case the function of the 72.42 will be to alternate the duty between both pumps, to even wear across both pumps. Should the liquid level rise above the Alarm level then the function of the 72.42 will call for the simultaneous operation of both pumps, by virtue of the signal to terminal B3 from the Alarm/Low level controller.

Note: due to the low level of 72.42 control signals, it is suggested to use level controller 72.01.8.240.5002 because of its superior low load switching capability.

Outline drawings

Types 72.01/11
Screw terminal

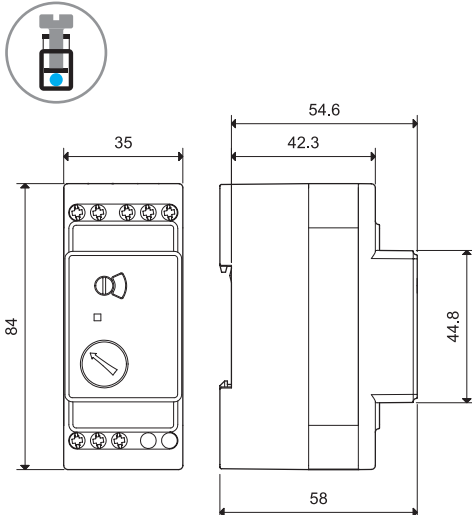

Type 72.42
Screw terminal

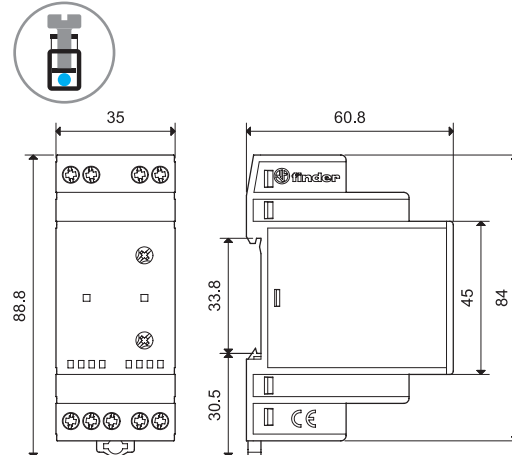

Accessories for 72.01 and 72.11



072.01.06

Suspended electrode for conductive liquids, complete with cable. Suitable for level monitoring in wells and reservoirs not under pressure.

- Electrode compatible with food processing applications (according to European Directive 2002/72 and cod. FDA title 21 part 177):

Cable length: 6 m (1.5 mm ²)	072.01.06
Cable length: 15 m (1.5 mm ²)	072.01.15



072.02.06

- Electrode for swimming pools with high levels of chlorine, or in salt-water pools with high levels of salinity:

Cable length: 6 m (1.5 mm ²)	072.02.06
--	-----------

Technical data	
Max. liquid temperature	°C +100
Electrode material	stainless steel (AISI 316L)

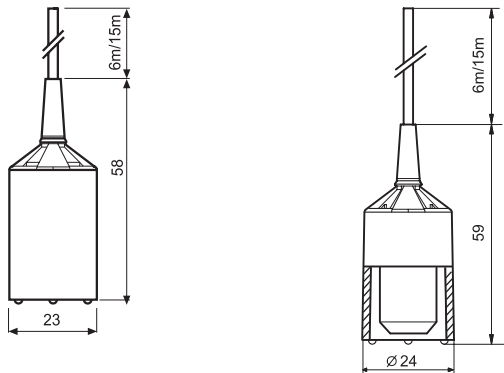

072.41

Suspended electrode	072.41
Technical data	
Max liquid temperature	°C +80
Cable grip	mm $\varnothing \leq 2.5 \dots 3.5$
Electrode material	stainless steel (AISI 316L)
Casing material	polypropylene
Max screw torque	Nm 0.7
Max. wire size	mm ² 1 x 2.5
	AWG 1 x 14
Wire strip length	mm 5...9

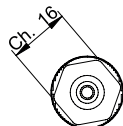
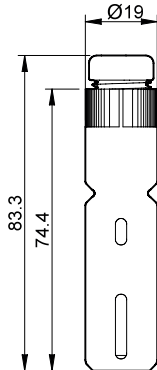

Accessories for 72.01 and 72.11



072.11

Floor water sensor , designed for the detection and reporting of the presence of floor surface water.		072.11
Technical data		
Electrode material	stainless steel (AISI 301)	
Wire capability of terminals		
Max screw torque	Nm	0.8
Max. wire size	solid cable	
	mm ²	1 x 6 / 2 x 6
	AWG	1 x 10 / 2 x 10
		stranded cable
		1 x 6 / 2 x 4
		1 x 10 / 2 x 12
Wire strip length	mm	9
Other data		
Distance between electrodes and floor	mm	1
Floor fixing screw diameter	Maximum M5	
Maximum cable diameter	mm	10
Maximum length of cable connecting sensor to relay	m	200 (with capacitance of 100 nF/km)
Max. liquid temperature	°C	+100

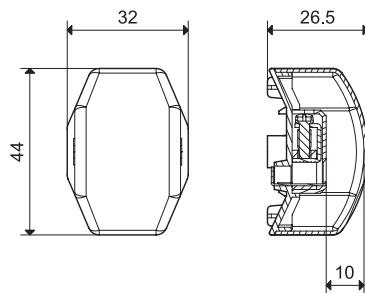

Floor surface water sensor for connection to electrode terminals (B1 and B3) of 72.01 or 72.11 level control relay, set in Emptying function (ES or E respectively).

For ice bank control in refrigeration systems it is suggested to use the high sensitivity (5...450)kΩ types - 72.01.8.024.0002 or 72.01.8.230.0002.

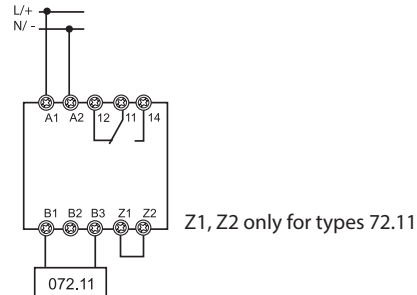
Function

072.51

Electrode holder with two pole connector , one connected directly to the electrode and the second connected to the grounded installation thread. Suitable for metal tank with G3/8" linkage. Electrode not included. Order appropriate number of electrodes holders - additional to the relay.		072.51
Technical data		
Max liquid temperature	°C	+100
Max tank pressure	bar	12
Cable grip	mm	∅ ≤ 6
Electrode material	stainless steel (AISI 316L)	

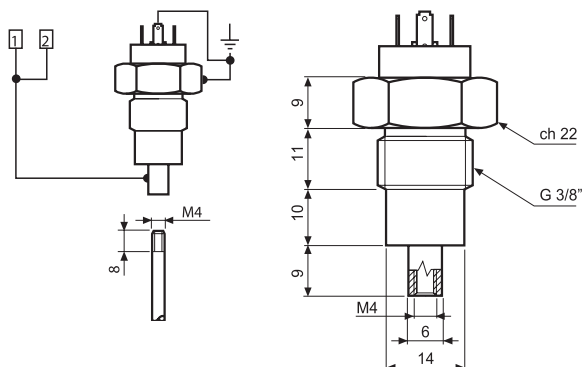

Accessories for 72.01 and 72.11



072.53

Electrode holder with three poles. Electrode not included.		
Order appropriate number of electrodes holders - additional to the relay.		072.53
Technical data		
Max liquid temperature	°C	+70
Electrode material		stainless steel (AISI 303)

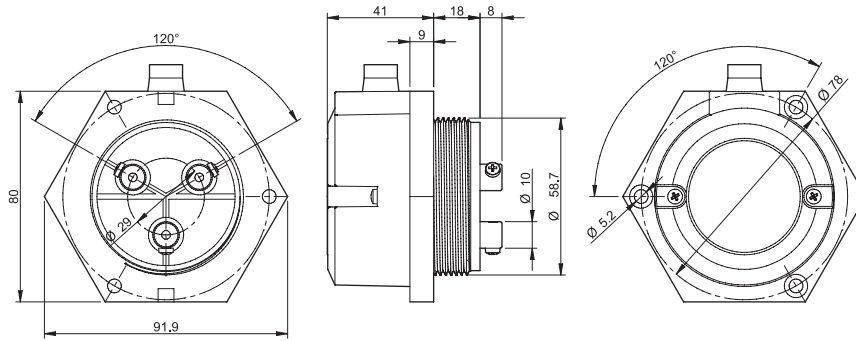

Electrode and electrode connector, multiple electrodes may be interconnected to provide required length

Technical data		
Electrode - 475 mm long, M4 thread, stainless steel (AISI 316L)		072.500
Inter-electrode connector - M4 thread, stainless steel (AISI 316L)		072.501

072.500



072.501

Illustration of interconnection of electrodes.



Electrode separator	072.503
----------------------------	---------



072.503

Adaptor for panel mounting , plastic, 35 mm wide	011.01
---	--------



011.01

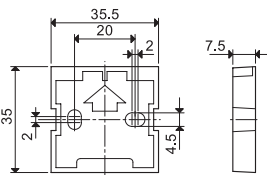

Sheet of marker tags (CEMBRE Thermal transfer printers) for relays types 72.42 (48 tags), 6 x 12 mm	060.48
--	--------

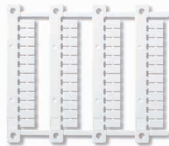

060.48

Identification tag , plastic, 1 tag, 17 x 25.5 mm (for 72.42 only)	019.01
---	--------



019.01

Application notes for 72.01 and 72.11

Applications

The main application for these relays is for the sensing and control of the level of conductive liquids.

Selectable options allow for this control to be achieved either through a filling operation or through an emptying operation, and in either case "positive logic" is used.

Level control can be achieved around a single level - using 2 electrodes, or between Minimum and Maximum levels - using 3 electrodes.

Additionally, the 72.01, with its adjustable sensitivity setting, can be ideal for monitoring the conductivity of liquids.

Positive safety logic

These relays work according to the principle that it is the closure of a normally open output contact that will be used to control the pump, both in filling and emptying applications. Consequently, in the event of a failure of the supply local to the relay, the filling or emptying will cease. This is generally considered to be the safest option.

Overrunning of tank on filling

Care must be exercised to ensure that the tank cannot overrun. Factors that have to be considered are the pump performance, the rate of discharge from the tank, the position of the single level electrode (or maximum electrode), and the run-on time delay. Keeping the time delay to a minimum will minimise the possibility of tank overrun, but will increase the installed switching rate.

Prevent dry running of pump on emptying

Care must be exercised to ensure that the pump cannot run dry. Similar considerations must be given as outlined above. In particular, keeping the run-on time delay to a minimum will minimise the risk, but again, it will increase the installed switching rate.

Run-on time

In commercial and light industrial applications the use of a short Run-on time delay is more appropriate, due to the relatively small size of tanks and the consequential need to react quickly to the change in level. Larger scale industrial applications involving larger tanks and powerful pumps must avoid a frequent switching cycle, and the use of the 72.01 set for the longer Run-on time of 7 seconds is suggested.

Note that the short run-on time will always achieve closer control to the desired level(s), but at the cost of more frequent switching.

Electrical life of the output contact

The electrical life of the output contact will be enhanced where a larger distance between the Max. and Min. electrodes (3-electrode control) can be realised. A smaller distance, or level control to a single level (2-electrode control), will result in more frequent switching and therefore a shorter electrical life for the contacts. Similarly, the long run-on time will enhance, and the short time will reduce, electrical life.

Pump control

Small single-phase pumps within the kW (0.55 kW - 230 V AC) rating stated may be driven directly by the level relay output contact. However, where very frequent switching is envisaged, it is better to "slave" a higher power relay or contactor to drive the pump motor. Large pumps (singlephase and three-phase) will of course require an interposing contactor.

Water leakage and condensation in oil lubrication systems

To detect condensed water vapour or water leakage within lubricating systems, monitor by sensors connected to B1 - B3 (Function E or ES, Z1 - Z2 linked). Condensed water vapour has low conductivity, therefore choose monitoring relay type 72.01.8.240.0002 with sensitivity range of (5...450) k Ω and sensor type 072.11.

Floor flooding control

To detect floor water due to spills or flooding, monitor using sensors connected to B1 - B3 (Function E or ES, Z1 - Z2 linked).

Choose monitoring relay type 72.01.8.240.0000 or 72.11.8.240.0000, together with floor water sensor type 072.11.

Electrodes and cable lengths

Normally 2 electrodes or 3 electrodes will be required for control about a single level, or control between Min. and Max. levels, respectively. However, if the tank is made of conductive material it is possible to use this as the common electrode, B3, if electrical connection can be made to it.

The maximum permitted length of cable between the electrode and the relays is 200m, for a cable not exceeding 100 nF/km.

A maximum of 2 relays and associated electrodes can be employed in the same tank - if two different levels need monitoring.

Note: It is permitted to make direct electrical connection between terminals B1-B3, and B2-B3, (without using electrodes/liquid), but in this case it is not possible to set up the sensitivity.

Electrode choice

The choice of electrodes may depend on the liquid being monitored. Standard electrodes 072.01.06 and 072.51 are suitable for many applications but some liquids may be corrosive for example, and may therefore require custom made electrodes - but these can usually be used with the 72.01 and 72.11 relays.

On site commissioning

To confirm the suitability of the relay sensitivity to the resistance between electrodes it is suggested that the following checks are made. For convenience it is suggested that the fill function and the shortest run-on time are selected.

Commissioning

Follow these setting-up instructions to achieve correct operation:

72.01

Select the function "FS" (Filling and Short delay of 0.5 s), and set the sensitivity control to 5 k Ω . Ensure that all electrodes are immersed in the liquid - expect the output relay to be ON. Then, slowly rotate the sensitivity control in the 150 k Ω direction until the level relay switches OFF (internal output relay will switch OFF and red LED will switch slowly flash).

(If the level relay does not switch OFF then, either the electrodes are not immersed, or the liquid has too high impedance or the distance between electrodes is too long).

Finally, select the filling or emptying function as required, run in real time and confirm that the level relay works as required.

72.11

Select the Filling function "F", (Z1 - Z2 open). Ensure that all electrodes are immersed in the liquid, but leave electrode B3 disconnected - output relay should be ON. Connect electrode B3, and the level relay should switch OFF (internal output relay will switch OFF and red LED will switch slowly flash).

(If the level relay does not switch OFF then, either the electrodes are not immersed, or the liquid has too high impedance or the distance between electrodes is too long.)

Finally, select the filling or emptying function as required, run in real time and confirm that the level relay works as required.

Float switch suitable for fluid level regulation

- 1 CO (SPDT)
- 10 A (resistive load)
- 8 A (inductive load)
- Cable length 5 m, 10 m, 15 m or 20 m
- Suitable for emptying and filling
- Contact material AgNi

72.A1.1000.xxxx



- Float switch for grey water pumping and drainage
- Counterweight (110 g) with cable grip, included

72.A1.0000.xx02



- Float switch for fluid foodstuff and potable water
- Suitable for swimming pools with high levels of chlorine, or in salt-water pools with high levels of salinity
- Counterweight (110 g) with cable grip, included
- Cable and plastics ACS certified for alimentary uses

72.B1.1000.xxxx



- Float switch for black water systems, drainage plants and pumping stations

* H05 RN F cable approved TÜV

For outline drawing see page 19

Technical data

Contact configuration		1 CO (SPDT)	1 CO (SPDT)	1 CO (SPDT)
Rated current	A	10 A (8 A)	10 A (8 A)	10 A (8 A)
Rated voltage	V AC	250	250	250
Protection degree		IP 68	IP 68	IP 68
Max liquid temperature	°C	+45	+45	+45
Max pressure	BAR	10	10	10
Cable material		H05 RN F*	ACS	H05 RN F*
Body material		Polypropylene	Polypropylene	Polypropylene
Approvals (according to type)		CE UK EAC	CE UK ACS	CE UK EAC

E

Float switch suitable for fluid level regulation

- 1 CO (SPDT)
- 10 A (resistive load)
- 8 A (inductive load)
- Space saving version, for narrow spaces
- Manual switch for automatic (ON/OFF) or manual (always ON) operation
- Cable length 2 m
- Suitable for emptying and filling

NEW 72.C1.0000.0201



- Space saving version, for narrow spaces .
- Magnetic contact
- Cable length 2 m



Manual switch

* H07 RN F cable approved TÜV

For outline drawing see page 20

Technical data

Contact configuration		1 CO (SPDT)
Rated current	A	10 A (8 A)
Rated voltage	V AC	250
Minimum switching load	mW (V/mA)	1200 (12/100)
Breaking capacity DC1		6 A - 30 V DC
Protection degree		IP 68
Max liquid temperature	°C	+50
Max depth	m	10
Cable material		H07 RN F*
Body material		Polypropylene
Approvals (according to type)		CE UK EAC

E

Ordering information

Example: 72 Series, float switch, 1 CO (SPDT).

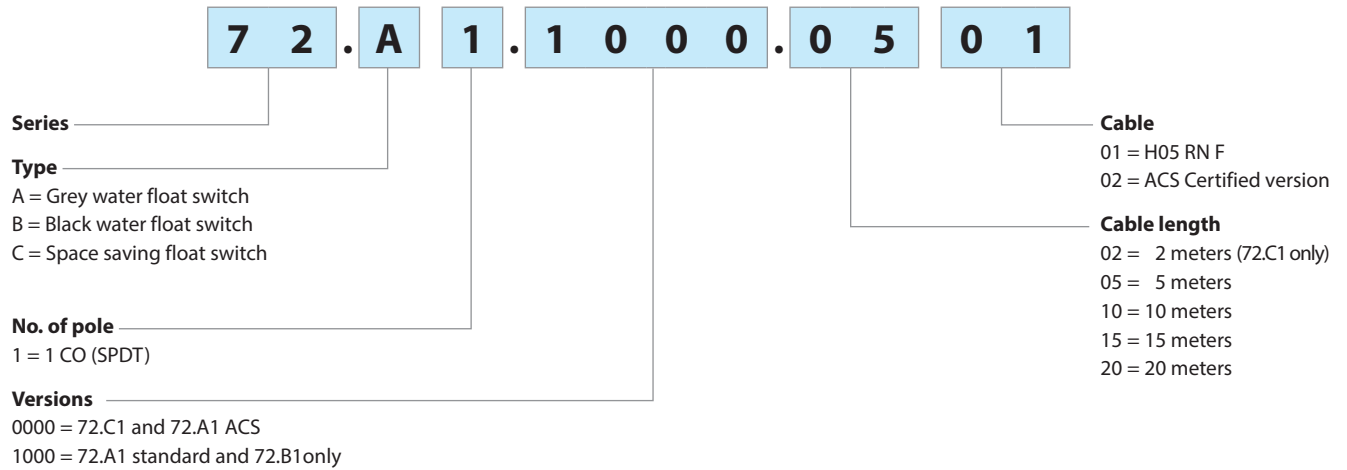

Accessories - Included in the package

Counterweight for type 72.A1



Counterweight (110 g) for Type 72.A1. Fixes to the cable to allow adjustment of the overall level and the switching hysteresis.



Mounting bracket and clamps to simplify wall or pipe installation.

E

Applications

Type 72.A1

Emptying function

Filling function

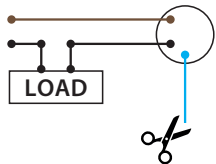
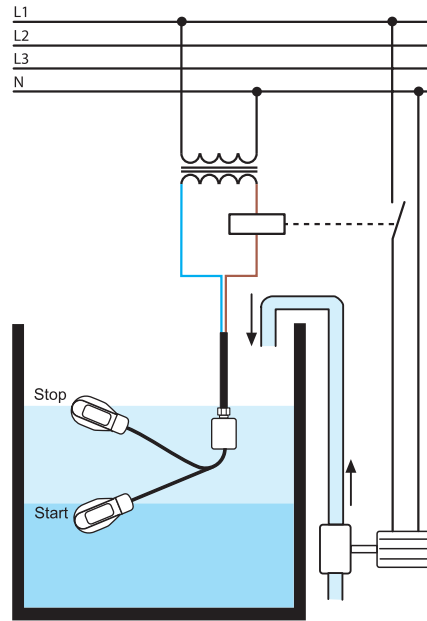
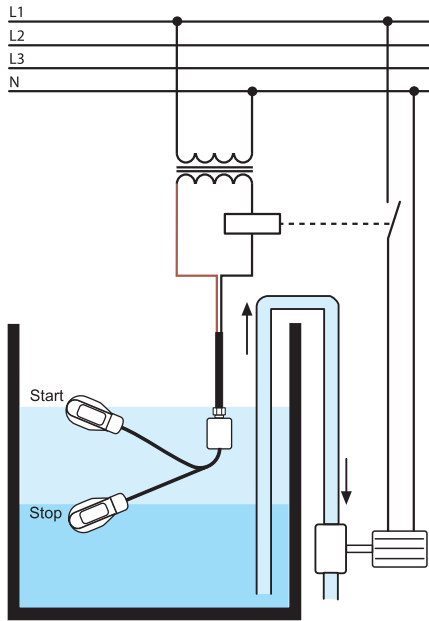

When black and brown wires are used, the circuit opens when the float is down and closes when the float is up. In this case the blue wire must be insulated.

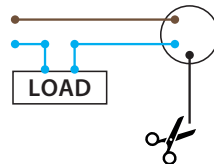

When brown and blue wires are used, the circuit opens when the float is up and closes when the float is down. In this case the black wire must be insulated.

Type 72.B1

Emptying function

Filling function

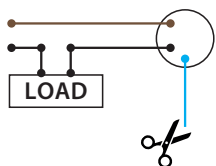
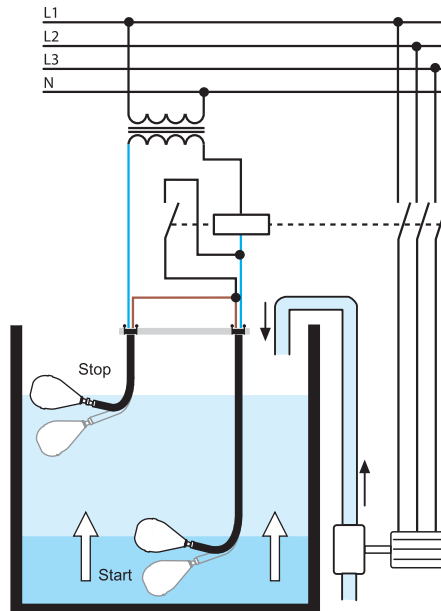
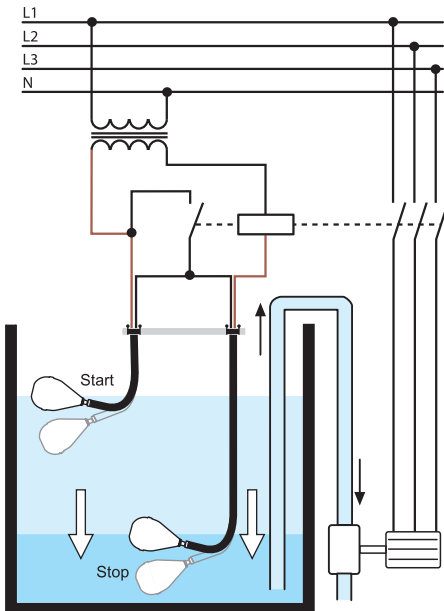

When black and brown wires are used, the circuit opens when the float is down and closes when the float is up. In this case the blue wire must be insulated.

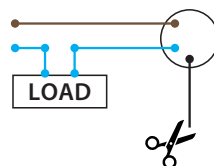

When brown and blue wires are used, the circuit opens when the float is up and closes when the float is down. In this case the black wire must be insulated.

Example

Type 72.C1

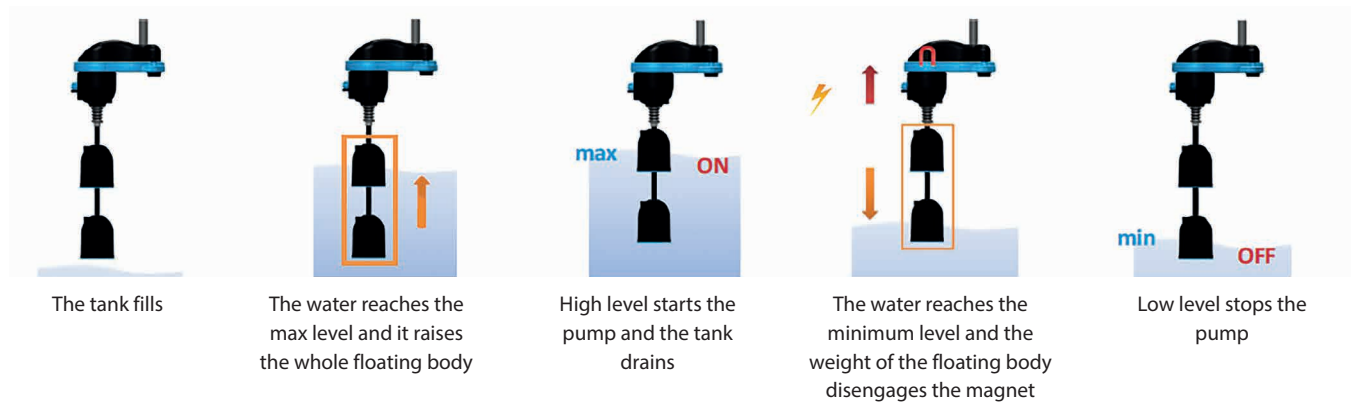

Functions

Emptying: when black and brown wires are used, the circuit opens when float is down and closes when the float is up.
Note: the blue/grey wire must be insulated.

Filling: when black and blue/grey wires are used, the circuit closes when float is down and opens when the float is up.
Note: the brown wire must be insulated.

N.B: The grounding wire is always yellow and green.

Outline drawings

Type 72.A1- xx02

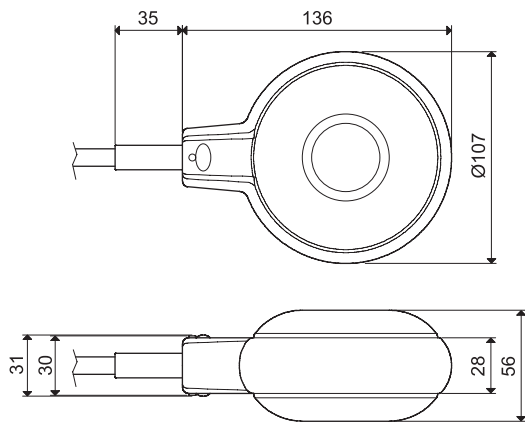

Type 72.A1

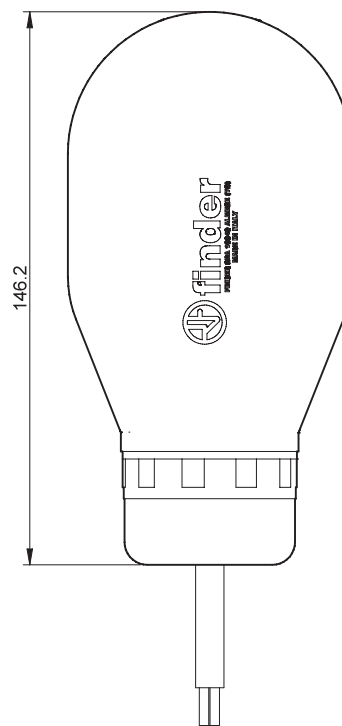

Type 72.B1

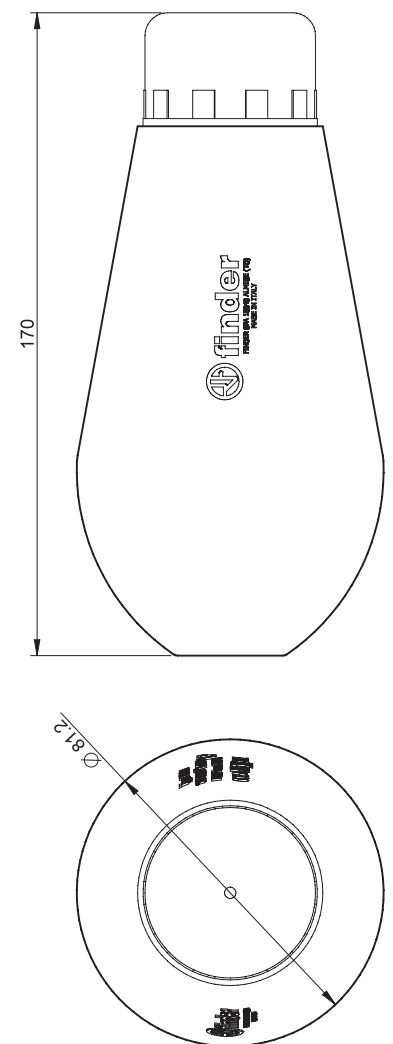

Outline drawings

Type 72.C1

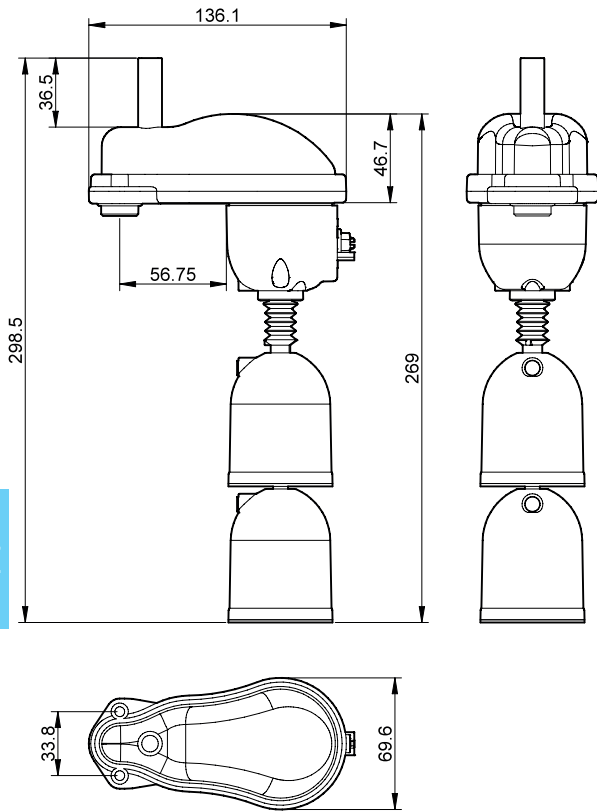

E