

Quick-Info Reed-Technology

1. How does a Reed Switch work?

A Reed Switch consists of a pair of ferromagnetic reeds, which overlap at their free ends (contact area) at a very small distance and are hermetically sealed in a glass tube. When in the presence of a magnetic field, the reeds become magnetized to opposite polarity, thus attracting each other and closing contact.

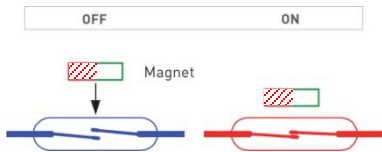

2. Different Reed Switch types

Generally speaking the different types are:

- › **Form A**, which is also known as **SPST-NO** (Single Pole Single Throw - Normally Open)
- › **Form B**, which is also known as **SPST-NC** (Single Pole Single Throw - Normally Closed)
- › **Form C**, or change over contact, which is also known as **SPDT** (Single Pole Double Throw)
- › **Form E** is a bi-stable contact. The switching state of this is also called **Latching-Type** and remains unchanged (even in the absence of a magnetic field) until a magnetic field of the opposite polarity is present

Furthermore, there are a number of special Reed Switches, i.e. for High Voltage applications or ultra miniature types for implants etc.

3. Technical Terms

AT stands for Ampere-Turns. It is a standard unit categorizing the magnetic sensitivity of Reed Switches. The AT value is measured by centering the Reed Switch in a standard coil, to which an increasing current is applied. At a certain current (Amps), the Reed Switch closes by means of the magnetic field generated by the coil. This is the **Operate** (or **Pull In**) value, which is calculated as Amps x number of coil turns = AT. The **Release** (or **Drop Out**) value can be obtained by reducing the current passing through the coil until the switch re-opens.

- › High AT value = low sensitivity. Thus, a strong magnetic field is necessary to operate the Reed Switch (respectively the switching distance between magnet and switch will be smaller)
- › Low AT value = high sensitivity, allowing the switch to operate even with a weaker magnetic field (respectively the switching distance between magnet and switch can be increased)

Hysteresis is the difference between the **Operate AT** and **Release AT** of a Reed Switch, i.e. a Reed Switch contact closes when approaching a magnet to a 10 mm distance. However, the switch will re-open at a magnet distance of 12 mm.

Some special Reed Switches feature a very low hysteresis ('close differential' types).

4. Operation

Generally speaking, **four** different magnet approaches can be considered when using permanent magnets.

4.1 One magnet pole faces the Reed Switch providing a maximum of two operations when moving on the X-axis. Minimal movement of the magnet over the switch center provides the smallest possible switching differential.

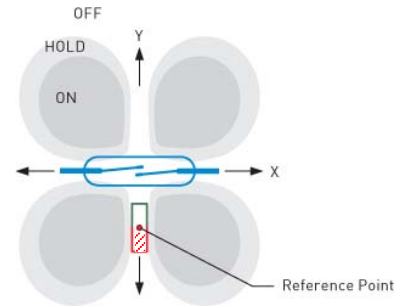

4.2 Magnet parallel to longitudinal axis of switch. Approaching the magnet **vertically** to the switch on the Y-axis provides one operation only. Driving the magnet over the full length of the switch (X-axis) may result in up to three operations. Minimal movement of the magnet over the switch center provides the smallest possible switching differential.

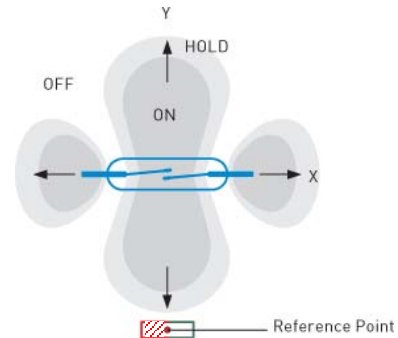

4.3 Rotation Switch operation by rotation of magnet. This gives two operations per complete rotation.

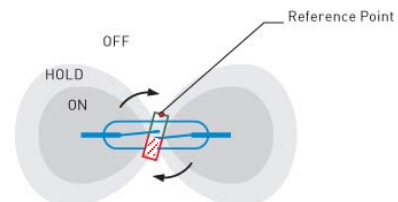

4.4 Operation of switch by shielding. This method requires a permanently opposite location of the magnet and switch. The switch is held closed continuously and will only release if the magnet flux is removed by means of a ferromagnetic shield.

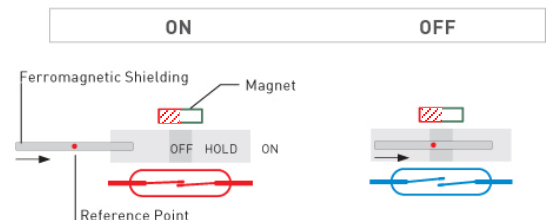

5. Handling/Treatment

5.1 Shock Resistance

In general, Reed Switches provide a high shock resistance of up to 100 g. However, a drop on a hard surface can still generate a shock of several 100 g, which can result in the de-adjustment of contacts. Switches that have been dropped should be re-tested for sensitivity before usage!

5.2 Do's and Don'ts when cutting and bending

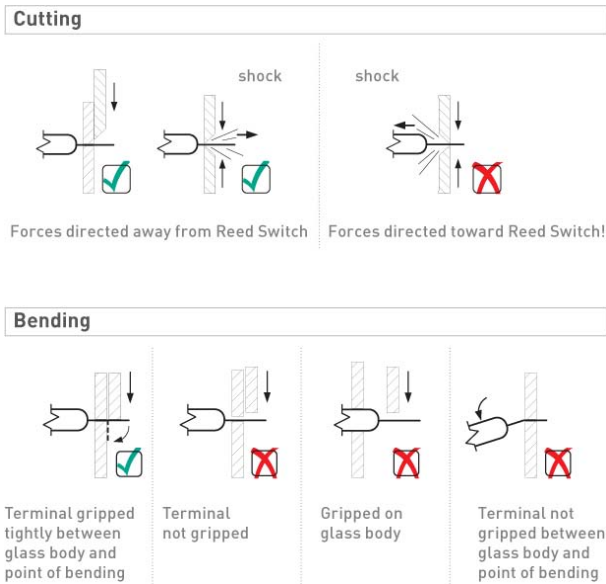

5.3 Dimensioning of modified Reed Switches

We supply Reed Switches with terminals that can be modified to almost any requirement. Dimensioning should be made according to the examples below.

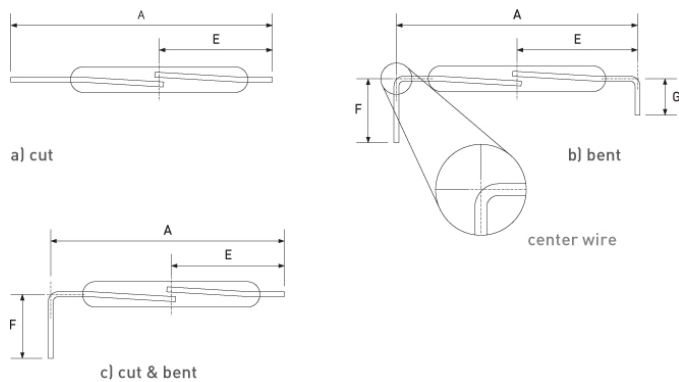

Further Information

Further information about our products, their technical specifications, applications and operation as well as information about Magnets are available on our website:

<http://pic-gmbh.com/en/tech-center/reed-switches/faq/>
<http://pic-gmbh.com/en/catalogue/view-online/>

PIC GmbH

Nibelungenstr. 5A
90530 Wendelstein, Germany

Phone +49 911 995906-0
Fax +49 911 995906-99
Mail info@pic-gmbh.com

 [Facebook.com/picgmbh](https://www.facebook.com/picgmbh)

© PIC GmbH, 04/2011

Important Info when testing Reed Switches:

- Always consider the relevant data sheet, especially with regard to the mentioned maximum values.
- Always control the coil's current during the test.
- Check the position of the Reed Switch within the test coil. A change in position might cause different AT measurements.
- Consider external magnetic fields: Even the earth's own magnetic field can result in a variance of 1 AT. External magnetic fields could be caused by nearby fans, motors etc.
- Ferromagnetic materials (e.g. screws) close to the test coil can distort the measurements.
- Large stresses on the glass tube or the leads might result in damage or maladjustments.
- Reed Switches are designed to operate under specific temperature conditions. Operating under higher temperatures than those specified can result in an increase of the Pull In value. In addition, magnets are temperature-sensitive and have a maximum operating temperature.
- Reeds and leads are parts of the magnetic circuit. Bending and cutting of the leads will cause changes in Pull In (PI) and Drop Out (DO) values.

Lifetime/Contact Protection

Lifetime depends on load conditions. If switching signal loads only, many millions, and indeed even billions of switching cycles can be achieved. Meanwhile, higher loads (e.g. mains applications or high currents) may provide from 10,000 up to a few million switching cycles. Usually the Reed Switch lifetime itself is much longer than the lifetime of the device incorporating the Reed Switch. As a general rule the same contact protection as for common mechanical switches (varistors, diodes, RCs) should be provided for Reed Switches to prevent the reduction of life expectancy.

Switching of lamp loads: Bulbs with a tungsten filament have approximately 10 times less resistance when they are cold, as compared to a switched on glowing bulb. This means a 10 times higher current occurring during the switching process. This current can be reduced by a resistor connected in series. Another possibility is the parallel connection of a resistor to the switch, in order to pre-heat the filament close to the glowing temperature.

Please do not hesitate to contact us if you have any questions regarding the test procedure or our protocols. We would be happy to help you with any enquiries.