

Fully Sealed Relay with High Impulse Dielectric for Use in Telecommunications Equipment

- High sensitivity can be driven by digital circuits.
- Horizontal design allows use in 1/2-inch PCB racks.
- Impulse withstand voltage meets FCC Part 68 requirements.
- Relays can be mounted side-by-side due to low magnetic leakage.
- Single- and double-winding latching relays also available.
- Special models available for low thermoelectromotive force.



RoHS Compliant Refer to pages 16 to 17 for details.

Ordering Information

Single-side Stable Type

Contact		Ag + Au-Alloy
General purpose	DPDT	G6A-274P-ST-US
	4PDT	G6A-474P-ST-US
Low-sensitivity	DPDT	G6A-274P-ST40-US
	4PDT	G6A-474P-ST40-US

Single-winding Latching Type

Contact		Ag + Au-Alloy
General purpose	DPDT	G6AU-274P-ST-US
	4PDT	G6AU-474P-ST-US

Double-winding Latching Type

Contact		Ag + Au-Alloy
General purpose	DPDT	G6AK-274P-ST-US
	4PDT	G6AK-474P-ST-US
Low-sensitivity	DPDT	G6AK-274P-ST40-US
	4PDT	G6AK-474P-ST40-US

Note: When ordering, add the rated coil voltage to the model number.
Example: G6A-274P-ST-US 12 VDC

Rated coil voltage

Model Number Legend

G6A - - - VDC
1 2 3 4 5 6 7 8 9

1. Relay Function

None: Single-side stable
U: Single-winding latching
K: Double-winding latching

2. Contact Form

2: DPDT
4: 4PDT

3. Contact Type

7: Bifurcated crossbar
Ag (Au-Alloy) contact

4. Enclosure Ratings

4: Fully sealed

5. Terminals

P: Straight PCB

6. Stand-off

ST: Stand-off 0.64 mm

7. Special Function

40: Low-sensitivity (400 mW)
LT: Low thermoelectromotive force

8. Approved Standards

US: UL, CSA certified

9. Rated Coil Voltage

3, 4.5, 5, 6, 9, 12, 24, 48 VDC

Specifications

■ Coil Ratings

General-purpose, DPDT Relays

Rated voltage	3 VDC	4.5 VDC	5 VDC	6 VDC	9 VDC	12 VDC	24 VDC	48 VDC
Rated current	66.7 mA	44.6 mA	40 mA	33.3 mA	22.2 mA	16.7 mA	8.3 mA	4.9 mA
Coil resistance	45 Ω	101 Ω	125 Ω	180 Ω	405 Ω	720 Ω	2,880 Ω	9,750 Ω
Coil inductance (H) (ref. value)	Armature OFF	0.07	0.16	0.2	0.29	0.63	1.1	4.5
	Armature ON	0.065	0.14	0.18	0.26	0.57	1.06	4.1
Must operate voltage	70% max. of rated voltage							
Must release voltage	10% min. of rated voltage							
Max. voltage	200% of rated voltage at 23°C							
Power consumption	Approx. 200 mW						Approx. 235 mW	

General-purpose, 4PDT Relays

Rated voltage	3 VDC	4.5 VDC	5 VDC	6 VDC	9 VDC	12 VDC	24 VDC	48 VDC
Rated current	120 mA	79.9 mA	72.5 mA	60 mA	40 mA	30 mA	15 mA	7.5 mA
Coil resistance	25 Ω	56.3 Ω	69 Ω	100 Ω	225 Ω	400 Ω	1,600 Ω	6,400 Ω
Coil inductance (H) (ref. value)	Armature OFF	0.05	0.11	0.14	0.2	0.45	0.8	3.2
	Armature ON	0.045	0.095	0.12	0.17	0.38	0.68	2.7
Must operate voltage	70% max. of rated voltage							
Must release voltage	10% min. of rated voltage							
Max. voltage	150% of rated voltage at 23°C							
Power consumption	Approx. 360 mW							

Low-sensitivity DPDT Relays

Rated voltage	3 VDC	4.5 VDC	5 VDC	6 VDC	9 VDC	12 VDC	24 VDC	48 VDC
Rated current	133.3 mA	88.9 mA	80 mA	66.7 mA	44.3 mA	33.3 mA	16.7 mA	8.3 mA
Coil resistance	22.5 Ω	50.6 Ω	62.5 Ω	90 Ω	203 Ω	360 Ω	1,440 Ω	5,760 Ω
Coil inductance (H) (ref. value)	Armature OFF	0.03	0.065	0.08	0.11	0.27	0.52	2.1
	Armature ON	0.02	0.06	0.07	0.1	0.23	0.43	1.8
Must operate voltage	70% max. of rated voltage							
Must release voltage	10% min. of rated voltage							
Max. voltage	150% of rated voltage at 23°C							
Power consumption	Approx. 400 mW							

Low-sensitivity 4PDT Relays

Rated voltage	3 VDC	4.5 VDC	5 VDC	6 VDC	9 VDC	12 VDC	24 VDC	48 VDC
Rated current	133.3 mA	88.9 mA	80 mA	66.7 mA	44.3 mA	33.3 mA	16.7 mA	8.3 mA
Coil resistance	22.5 Ω	50.6 Ω	62.5 Ω	90 Ω	203 Ω	360 Ω	1,440 Ω	5,760 Ω
Coil inductance (H) (ref. value)	Armature OFF	0.035	0.1	0.12	0.17	0.42	0.7	2.8
	Armature ON	0.02	0.07	0.09	0.13	0.3	0.52	2.2
Must operate voltage	70% max. of rated voltage							
Must release voltage	10% min. of rated voltage							
Max. voltage	150% of rated voltage at 23°C							
Power consumption	Approx. 400 mW							

- Note:**
1. The rated current and coil resistance are measured at a coil temperature of 23°C with a tolerance of ±10%.
 2. Operating characteristics are measured at a coil temperature of 23°C.
 3. The maximum voltage is the highest voltage that can be imposed on the relay coil.

Single-winding Latching, DPDT Relays

Rated voltage	3 VDC	4.5 VDC	5 VDC	6 VDC	9 VDC	12 VDC	24 VDC	48 VDC	
Rated current	33.7 mA	22.2 mA	20 mA	16.7 mA	11.1 mA	8.3 mA	4.2 mA	2.5 mA	
Coil resistance	89 Ω	202 Ω	250 Ω	360 Ω	810 Ω	1,440 Ω	5,760 Ω	19,000 Ω	
Coil inductance (H) (ref. value)	Armature OFF	0.15	0.34	0.44	0.64	1.38	2.5	9.2	28.5
	Armature ON	0.11	0.25	0.35	0.48	1.07	2	7.2	22
Must operate voltage	70% max. of rated voltage								
Must release voltage	70% max. of rated voltage								
Max. voltage	200% of rated voltage at 23°C								
Power consumption	Approx. 100 mW							Approx. 120 mW	

Single-winding Latching, 4PDT Relays

Rated voltage	3 VDC	4.5 VDC	5 VDC	6 VDC	9 VDC	12 VDC	24 VDC	48 VDC	
Rated current	106.8 mA	71.2 mA	64 mA	53.3 mA	35.6 mA	26.7 mA	13.3 mA	6.7 mA	
Coil resistance	28.1 Ω	63.2 Ω	78.1 Ω	112.5 Ω	253 Ω	450 Ω	1,800 Ω	7,200 Ω	
Coil inductance (H) (ref. value)	Armature OFF	0.03	0.06	0.08	0.11	0.25	0.45	1.8	7
	Armature ON	0.02	0.04	0.06	0.08	0.18	0.32	1.3	5.2
Must operate voltage	70% max. of rated voltage								
Must release voltage	70% max. of rated voltage								
Max. voltage	150% of rated voltage at 23°C								
Power consumption	Approx. 320 mW								

Double-winding Latching, DPDT Relays

Rated voltage	3 VDC	4.5 VDC	5 VDC	6 VDC	9 VDC	12 VDC	24 VDC	48 VDC		
Rated current	66.7 mA	40.2 mA	36 mA	30 mA	20 mA	15 mA	7.5 mA	4.2 mA		
Coil resistance	45 Ω	112 Ω	139 Ω	200 Ω	450 Ω	800 Ω	3,200 Ω	11,520 Ω		
Coil inductance (H) (ref. value)	Set	Armature OFF	0.037	0.09	0.11	0.16	0.38	0.6	2.1	8.5
		Armature ON	0.027	0.065	0.08	0.12	0.28	0.45	1.5	6.3
	Reset	Armature OFF	0.027	0.065	0.08	0.12	0.28	0.45	1.5	6.3
		Armature ON	0.037	0.09	0.11	0.16	0.38	0.6	2.1	8.5
Must operate voltage	70% max. of rated voltage									
Must release voltage	70% max. of rated voltage									
Max. voltage	200% of rated voltage at 23°C									
Power consumption	Approx. 200 mW		Approx. 180 mW					Approx. 200 mW		

Double-winding Latching, 4PDT Relays

Rated voltage	3 VDC	4.5 VDC	5 VDC	6 VDC	9 VDC	12 VDC	24 VDC	48 VDC		
Rated current	106.8 mA	71.2 mA	64 mA	53.3 mA	35.6 mA	26.7 mA	13.3 mA	6.7 mA		
Coil resistance	28.1 Ω	63.2 Ω	78.1 Ω	112.5 Ω	253 Ω	450 Ω	1,800 Ω	7,200 Ω		
Coil inductance (H) (ref. value)	Set	Armature OFF	0.03	0.06	0.08	0.11	0.25	0.45	1.8	7
		Armature ON	0.02	0.04	0.06	0.08	0.18	0.32	1.3	5.2
	Reset	Armature OFF	0.02	0.04	0.06	0.08	0.18	0.32	1.3	5.2
		Armature ON	0.03	0.06	0.08	0.11	0.25	0.45	1.8	7
Must operate voltage	70% max. of rated voltage									
Must release voltage	70% max. of rated voltage									
Max. voltage	150% of rated voltage at 23°C									
Power consumption	Approx. 320 mW									

- Note:**
1. The rated current and coil resistance are measured at a coil temperature of 23°C with a tolerance of ±10%.
 2. Operating characteristics are measured at a coil temperature of 23°C.
 3. The maximum voltage is the highest voltage that can be imposed on the relay coil.

Double-winding Latching, Low-sensitivity DPDT Relays

Rated voltage			3 VDC	4.5 VDC	5 VDC	6 VDC	9 VDC	12 VDC	24 VDC	48 VDC
Rated current			120 mA	79.9 mA	72.5 mA	60 mA	40 mA	30 mA	15 mA	7.5 mA
Coil resistance			25 Ω	56.3 Ω	69 Ω	100 Ω	225 Ω	400 Ω	1,600 Ω	6,400 Ω
Coil inductance (H) (ref. value)	Set	Armature OFF	0.015	0.04	0.05	0.07	0.16	0.28	1.1	4
		Armature ON	0.01	0.025	0.035	0.05	0.12	0.2	0.75	2.9
	Reset	Armature OFF	0.01	0.025	0.035	0.05	0.12	0.2	0.75	2.9
		Armature ON	0.015	0.04	0.05	0.07	0.16	0.28	1.1	4
Must operate voltage			70% max. of rated voltage							
Must release voltage			70% max. of rated voltage							
Max. voltage			150% of rated voltage at 23°C							
Power consumption			Approx. 360 mW							

Double-winding Latching, Low-sensitivity 4PDT Relays

Rated voltage			3 VDC	4.5 VDC	5 VDC	6 VDC	9 VDC	12 VDC	24 VDC	48 VDC
Rated current			120 mA	79.9 mA	72.5 mA	60 mA	40 mA	30 mA	15 mA	7.5 mA
Coil resistance			25 Ω	56.3 Ω	69 Ω	100 Ω	225 Ω	400 Ω	1,600 Ω	6,400 Ω
Coil inductance (H) (ref. value)	Set	Armature OFF	0.02	0.045	0.065	0.09	0.18	0.3	1.2	4.4
		Armature ON	0.015	0.035	0.05	0.075	0.14	0.23	0.82	3.2
	Reset	Armature OFF	0.015	0.035	0.05	0.075	0.14	0.23	0.82	3.2
		Armature ON	0.02	0.045	0.065	0.09	0.18	0.3	1.2	4.4
Must operate voltage			70% max. of rated voltage							
Must release voltage			70% max. of rated voltage							
Max. voltage			150% of rated voltage at 23°C							
Power consumption			Approx. 360 mW							

- Note:**
1. The rated current and coil resistance are measured at a coil temperature of 23°C with a tolerance of ±10%.
 2. Operating characteristics are measured at a coil temperature of 23°C.
 3. The maximum voltage is the highest voltage that can be imposed on the relay coil.

■ Contact Ratings

Item	G6A-274P-ST(40)-US/474P-ST(40)-US	
Load	Resistive load ($\cos\phi = 1$)	Inductive load ($\cos\phi = 0.4$; L/R = 7 ms)
Rated load	0.5 A at 125 VAC; 2 A at 30 VDC	0.3 A at 125 VAC; 1 A at 30 VDC
Contact material	Ag (Au-Alloy)	
Rated carry current	3 A	
Max. switching voltage	250 VAC, 220 VDC	
Max. switching current	2 A	1 A
Max. switching power	125 VA, 60 W	62.5 VA, 30 W
Failure rate (reference value)	0.01 mA at 10 mVDC	

Item	G6AK-274P-ST(40)-US/G6AK-474P-ST(40)-US G6AU-274P-ST-US/G6AU-474P-ST-US	
Load	Resistive load ($\cos\phi = 1$)	Inductive load ($\cos\phi = 0.4$; L/R = 7 ms)
Rated load	0.5 A at 125 VAC; 2 A at 30 VDC	0.25 A at 125 VAC; 1 A at 30 VDC
Contact material	Ag (Au-Alloy)	
Rated carry current	3 A	
Max. switching voltage	250 VAC, 220 VDC	
Max. switching current	2 A	1 A
Max. switching power	125 VA, 60 W	62.5 VA, 30 W
Failure rate (reference value) (See note.)	0.01 mA at 10 mVDC	

Note: P level: $\lambda_{60} = 0.1 \times 10^{-6}$ /operation

This value was measured at a switching frequency of 60 operations/min and the criterion of contact resistance is 50 Ω. This value may vary depending on the switching frequency and operating environment. Always double-check relay suitability under actual operating conditions.

■ Characteristics

Contact resistance (See note 1.)	50 mΩ max.
Operate (set) time (See note 2.)	Single-side stable types: DPDT: 5 ms max. (approx. 3 ms) 4PDT: 7 ms max. (approx. 3.8 ms) Latching types: DPDT: 5 ms max. (approx. 2.5 ms) 4PDT: 7 ms max. (approx. 3.3 ms)
Release (reset) time (See note 2.)	Single-side stable types: DPDT: 3 ms max. (approx. 1.2 ms) 4PDT: 5 ms max. (approx. 1.3 ms) Latching types: DPDT: 5 ms max. (approx. 2.5 ms) 4PDT: 7 ms max. (approx. 2.7 ms)
Min. set/reset signal width	DPDT: 7 ms min. 4PDT: 15 ms min.
Max. operating frequency	Mechanical: 36,000 operations/hr Electrical: 1,800 operations/hr (under rated load)
Insulation resistance (See note 3.)	1,000 MΩ min. (at 500 VDC); except for set-reset
Dielectric strength	1,000 VAC, 50/60 Hz for 1 min between coil and contacts 1,000 VAC, 50/60 Hz for 1 min between contacts of different polarity 1,000 VAC, 50/60 Hz for 1 min between contacts of same polarity 250 VAC, 50/60 Hz for 1 min between set and reset coils
Impulse withstand voltage	1,500 V (10 x 160 μs) (conforms to FCC Part 68)
Vibration resistance	Destruction: 10 to 55 to 10 Hz, 2.5-mm single amplitude (5-mm double amplitude) Malfunction: 10 to 55 to 10 Hz, 1.65-mm single amplitude (3.3-mm double amplitude)
Shock resistance	Destruction: 1,000 m/s ² (approx. 100G) Malfunction: DPDT: 500 m/s ² (approx. 50G) 4PDT, Latching type: 300 m/s ² (approx. 30G)
Endurance	Mechanical: 100,000,000 operations min. (at 36,000 operations/hr) Electrical: 500,000 operations min. (at 1,800 operations/hr)
Ambient temperature	Operating: -40°C to 70°C (with no icing)
Ambient humidity	Operating: 5% to 85%
Weight	DPDT: Approx. 3.5 g 4PDT: Approx. 6 g

Note: The data shown above are initial values.

Note: 1. The contact resistance was measured with 10 mA at 1 VDC with a voltage drop method.

2. Values in parentheses are actual values.

3. The insulation resistance was measured with a 500-VDC megohmmeter applied to the same parts as those used for checking the dielectric strength (except between the set and reset coil).

■ Approved Standards

UL114, UL478 (File No. E41515)/CSA C22.2 No.0, No.14 (File No. LR31928)

Model	Contact form	Coil ratings	Contact ratings
G6A-274P-ST(40)-US G6AK-274P-ST(40)-US G6AU-274P-ST-US	DPDT	3 to 48 VDC	0.6 A, 125 VAC 2 A, 30 VDC 0.6 A, 110 VDC
G6A-474P-ST(40)-US G6AK-474P-ST(40)-US G6AU-474P-ST-US	4PDT		0.6 A, 125 VAC 2 A, 30 VDC 0.6 A, 110 VDC

Engineering Data

Maximum Switching Power DPDT, 4PDT

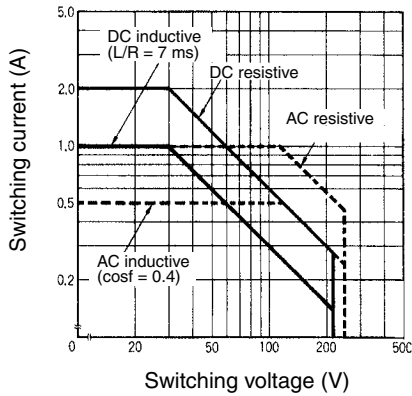

Ambient Temperature vs. Maximum Coil Voltage

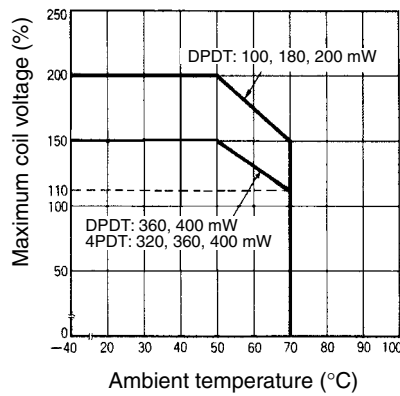

Note: The maximum coil voltage refers to the maximum value in a varying range of operating power voltage, not a continuous voltage.

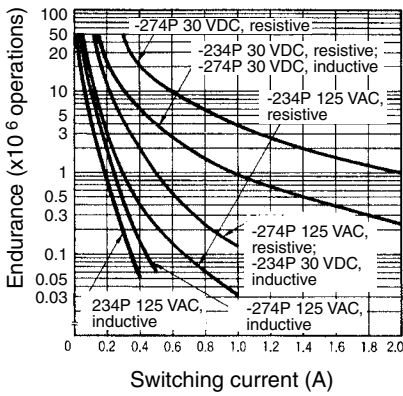

Endurance DPDT

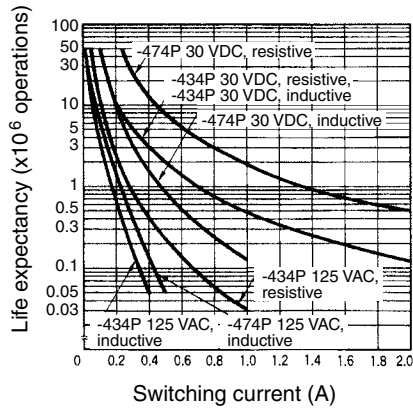

4PDT



Dimensions

- Note:** 1. All units are in millimeters unless otherwise indicated.
 2. Orientation marks are indicated as follows:  

G6A-274P-ST(40)-US

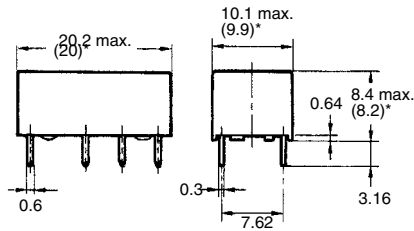
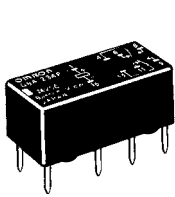

*Average value

Terminal Arrangement/ Internal Connections (Bottom View)

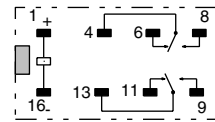

Mounting Holes (Bottom View) Tolerance: ±0.1

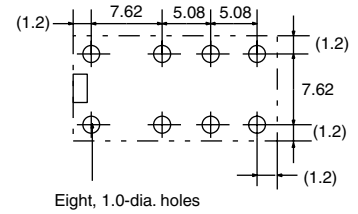

G6A-474P-ST-US

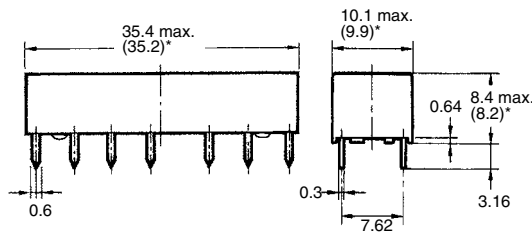
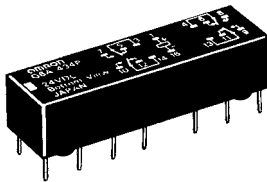

*Average value

Terminal Arrangement/ Internal Connections (Bottom View)

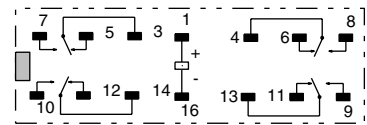

Mounting Holes (Bottom View) Tolerance: ±0.1

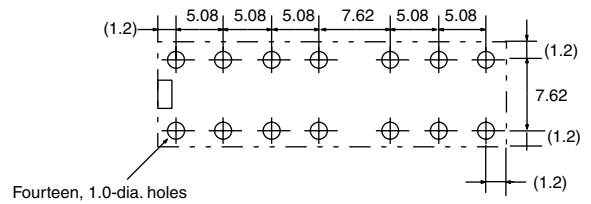

G6AK-274P-ST(40)-US

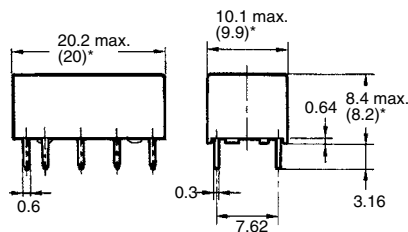
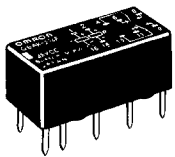

*Average value

Terminal Arrangement/ Internal Connections (Bottom View)

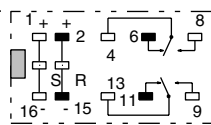

Mounting Holes (Bottom View) Tolerance: ±0.1

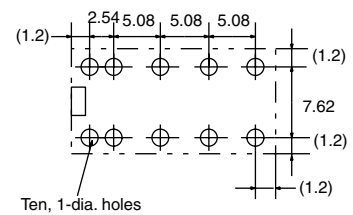

G6AK-474P-ST(40)-US

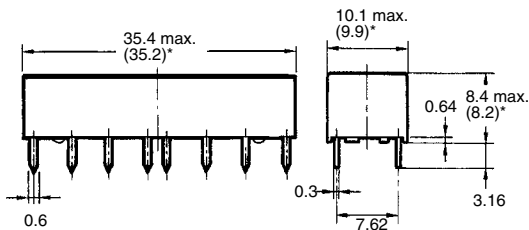
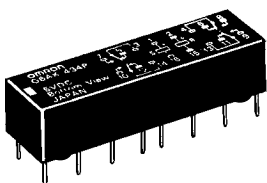

*Average value

Terminal Arrangement/
Internal Connections
(Bottom View)

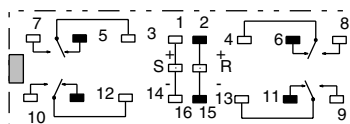

Mounting Holes
(Bottom View)

Tolerance: ± 0.1

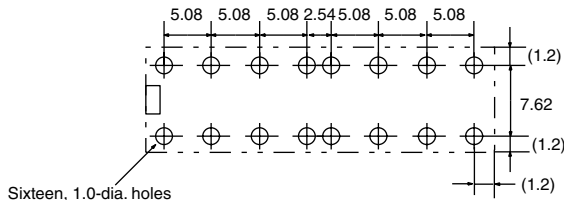

G6AU-274P-ST-US

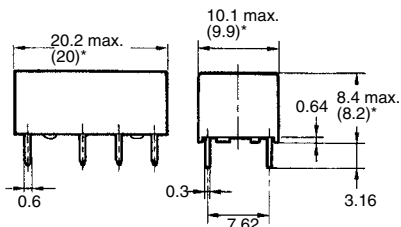
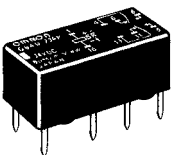

*Average value

Terminal Arrangement/
Internal Connections
(Bottom View)

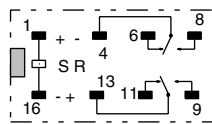

Mounting Holes
(Bottom View)

Tolerance: ± 0.1

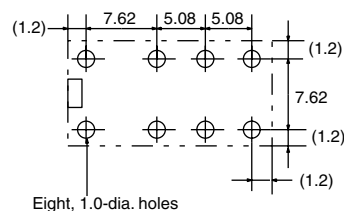

G6AU-474P-ST-US

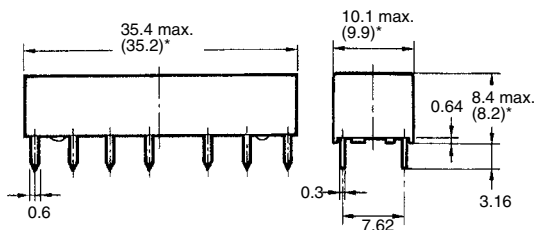
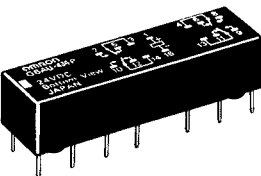

*Average value

Terminal Arrangement/
Internal Connections
(Bottom View)

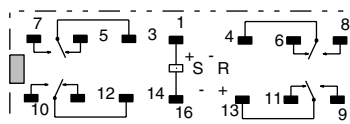

Mounting Holes
(Bottom View)

Tolerance: ± 0.1

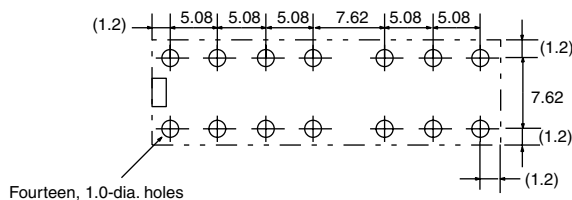

Precautions

Long-term Continuously ON Contacts

Using the Relay in a circuit where the Relay will be ON continuously for long periods (without switching) can lead to unstable contacts because the heat generated by the coil itself will affect the insulation, causing a film to develop on the contact surfaces. We recommend using a latching relay (magnetic-holding relay) in this kind of circuit. If a single-side stable model must be used in this kind of circuit, we recommend using a fail-safe circuit design that provides protection against contact failure or coil burnout.

Relay Handling

When washing the product after soldering the Relay to a PCB, use a water-based solvent or alcohol-based solvent, and keep the solvent temperature to less than 40°C. Do not put the Relay in a cold cleaning bath immediately after soldering.

ALL DIMENSIONS SHOWN ARE IN MILLIMETERS.

To convert millimeters into inches, multiply by 0.03937. To convert grams into ounces, multiply by 0.03527.