

**A Cubic, Single-pole 10-A
Power Relay**
**Single-pole 10A 35VDC, 0.8mm
contact gap: G5LE-G**
Single-pole 16A 250VAC: G5LE-E

- ROHS compliant.
- Sub-miniature ‘sugar cube’ relay with universal terminal footprint.
- Conforms to EN 61810-1, UL508, CSA22.2.
- Tracking resistance: CTI>250 (-VD, -E and -G types).
- UL class-F coil insulation model available (UL class-B coil insulation for standard model).
- Withstands impulse of up to 4,500 V.
- 400-mW and 360-mW coil power consumption types available.
- Pre-soldered terminals.



Ordering Information

Enclosure Rating	Contact Form	Contact Material	
		AgSnO ₂	AgSnIn
Flux protection	SPDT	G5LE-1 G5LE-1-VD G5LE-1-CF	G5LE-1-ASI G5LE-1-ASI-VD G5LE-1-ASI-CF
	SPST-NO	G5LE-1A G5LE-1A-VD G5LE-1A-CF	G5LE-1A-ASI G5LE-1A-ASI-VD G5LE-1A-ASI-CF
Fully sealed	SPDT	G5LE-14 G5LE-14-VD G5LE-14-CF	G5LE-14-ASI G5LE-14-ASI-VD G5LE-14-ASI-CF
	SPST-NO	G5LE-1A4 G5LE-1A4-VD G5LE-1A4-CF	G5LE-1A4-ASI G5LE-1A4-ASI-VD G5LE-1A4-ASI-CF

PCB Power Relay – G5LE

Note: When ordering, add the rated coil voltage to the model number.

Example: G5LE-1 12 VDC

_____ Rated coil voltage

Model Number Legend

G5LE - - - - - - - - **VDC**
 1 2 3 4 5 6 7 8 9 10

1. Number of Poles

1: 1 pole

2. Contact Form

None: SPDT

A: SPST-NO

3. Enclosure ratings

None: Flux protection

4: Fully sealed

(not applicable with -E and -G versions)

4. Contact Material

None: AgSnO₂

(AgSnIn for -E and -G versions)

ASl: AgSnIn

5. Insulation System

None: Class B

(Class F for -E and -G versions)

CF: Class F (UL and CSA only)

6. Coil Power Consumption/Coil Characteristic

None: Approx. 400 mW

(Approx 700mW applicable with -G versions)

36: Approx. 360 mW

(not applicable for -G version)

7. Classification

G: 0.8mm contact gap type

E: High capacity type

8. Approved Standards

None: UL, CSA, TÜV

VD: UL, CSA, TÜV and VDE

(Not applicable with "-CF.", -E and -G version)

9. Packaging

None: Standard polystyrene tray

SP: Anti-static tube packaging

10. Rated Coil Voltage

5, 9, 12, 24, 48 VDC

Specifications

■ Coil Ratings

700-mW Type (G5LE-G)

Rated voltage	9VDC	12VDC	20VDC	24VDC
Rated current	77.8mA	58.3mA	35.0mA	29.2mA
Coil resistance	115.7 Ω	205.7 Ω	571.4 Ω	822.9 Ω
Must operate voltage	75% of rated voltage (max)			
Must release voltage	10% of rated voltage (min)			
Max. voltage	120% of rated voltage at 85°C, 150% of rated voltage at 23°C			
Power consumption	Approx 700mW			

Note: The rated current and coil resistance are measured at a coil temperature of 23°C with a tolerance of ±10%.

400-mW Type

Rated voltage	5 VDC	9 VDC	12 VDC	24 VDC	48 VDC
Rated current	79.4 mA	45 mA	33.3 mA	16.7 mA	8.33 mA
Coil resistance	63 Ω	200 Ω	360 Ω	1,440 Ω	5,760 Ω
Must operate voltage	75% max. of rated voltage				
Must release voltage	10% min. of rated voltage				
Max. voltage	130% of rated voltage at 85°C, 170% of rated voltage at 23°C				
Power consumption	Approx. 400 mW				

Note: The rated current and coil resistance are measured at a coil temperature of 23°C with a tolerance of ±10%.

PCB Power Relay – G5LE

360-mW Type

Rated voltage	5 VDC	9 VDC	12 VDC	24 VDC	48 VDC
Rated current	72 mA	40 mA	30 mA	15 mA	7.5 mA
Coil resistance	70 Ω	225 Ω	400 Ω	1,600 Ω	6,400 Ω
Must operate voltage	75% max. of rated voltage				
Must release voltage	10% min. of rated voltage				
Max. voltage	130% of rated voltage (at 85°C), 170% of rated voltage (at 23°C)				
Power consumption	360 - 400mW				

Note: The rated current and coil resistance are measured at a coil temperature of 23°C with a tolerance of ±10%.

■ Contact Ratings

	Standard	G5LE-G	G5LE-E/-E-36
Load	Resistive load (cosφ = 1)	Resistive load (cosφ = 1)	Resistive load (cosφ = 1)
Rated Load	10A at 120VAC; 8A at 30VDC; 10A at 250VAC (12+24VDC)	10A at 35VDC	16A at 250VAC
Contact material	AgSnO ₂ (AgSnIn optional)	AgSnO ₂	AgSnIn
Rated Carry Current	10 A	10A	16A
Max. switching voltage	250VAC; 125VDC (30VDC when UL/USA standard is applied)	35VDC	250VAC
Max. switching current	AC: 10 A; DC: 8 A	DC: 10A	AC: 16A
Max. switching power	1,200 VA, 240 W	350W	4000VA
Failure rate (reference value)	100 mA at 5 VDC	100mA at 5VDC	100mA at 5VDC

■ Characteristics

Contact resistance	100 mΩ max.	
Operate time	10 ms max.	
Release time	5 ms max.	
Bounce Time	Operate: Approx. 0.6 ms Release: Approx. 7.2 ms	
Max. switching frequency	Mechanical: 18,000 operations/hr Electrical: 1,800 operations/hr at rated load	
Insulation resistance	100 MΩ min. (at 500 VDC)	
Dielectric strength	2,000 VAC, 50/60 Hz for 1 min between coil and contacts 750 VAC, 50/60 Hz for 1 min between contacts of same polarity 1,500VAC (for suffix -G) 50/60Hz for 1 min between contacts of same polarity	
Impulse withstand voltage	4,500 V (1.2 50 μs) between coil and contacts	
Insulation Distance	Creepage (Typ)	3.3 mm
	Clearance (Typ)	2.7 mm
Tracking Resistance (CTI)	250 V	
Vibration resistance	Destruction: 10 to 55 to 10 Hz, 0.75-mm single amplitude (1.5-mm double amplitude) Malfunction: 10 to 55 to 10 Hz, 0.75-mm single amplitude (1.5-mm double amplitude)	
Shock resistance	Destruction: 1,000 m/s ² Malfunction: 100 m/s ²	
Endurance	Mechanical: 10,000,000 operations min. (at 18,000 operations/hr) Electrical: 100,000 operations min. (at 1,800 operations/hr) (for standard type) 36,000 operations min. (10 A at 250 VAC) 100,000 operations min (at 1,800 operations/hr, 12A 250VAC) - applicable for G5LE-1-E normally open contact only)	
Ambient temperature	Operating: -40°C to 85°C (with no icing)	
Ambient humidity	Operating: 5% to 85%	
Weight	Approx. 12 g	

■ Approved Standards

UL508, UL114, UL478, UL325, UL873, UL1409, UL1950 (File No. E41643)/CSA C22.2 No. 14, No. 1 (File No. LR34815)

Model	Coil ratings	Contact ratings
G5LE	3 to 48 VDC	12 A, 120 VAC (resistive load 30,000 cycles) 10 A, 250 VAC (general use) 10 A, 125 VAC (general use 100,000 cycles) 8 A, 30 VDC (resistive load) 6 A, 277 VAC (general use) NO: 1/6 hp, 120 VAC (50,000 cycles) 1/3 hp, 125 VAC, 70°C 30K with Class 130B system 65°C 30K with Class 105 Coil insulation system TV-3, 120 VAC TV-5, 120 VAC (For ASI only) NC: 1/8 hp, 120 VAC (50,000 cycles) 1/10 hp, 120 VAC (50,000 cycles)

EN 61810-1, EN 60255, IEC (VDE TUV Reg No. R9151267, VDE Reg No. 6850UG)

Model	Coil ratings	Contact ratings
G5LE	Approx. 400 mW 3, 5, 6, 9, 12, 24, 48 VDC Approx. 360 mW 5, 6, 12, 24, 48 VDC	10A, 250 VAC (resistive load 50,000 cycles at 85°C) 5A, 30VDC 2.5A, 250VAC (cosφ = 0.4)

Engineering Data

For standard type

**Maximum Switching Power
G5LE**

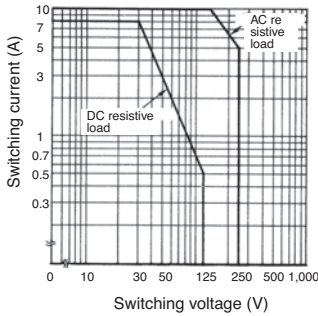

**Endurance
G5LE**

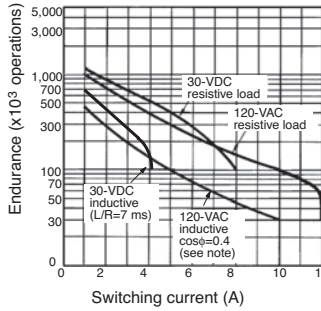

Note: Same curve as for 250-VAC resistive load

**Ambient Temperature vs.
Maximum Coil Voltage**

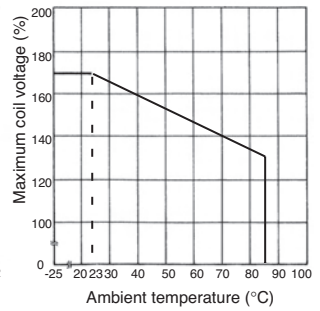

Note: The maximum coil voltage refers to the maximum value in a varying range of operating power voltage, not a continuous voltage.

For suffix -E and -G

Max. Switching Capacity

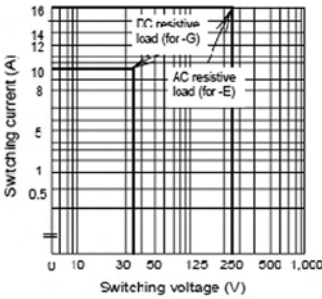

Life Expectancy

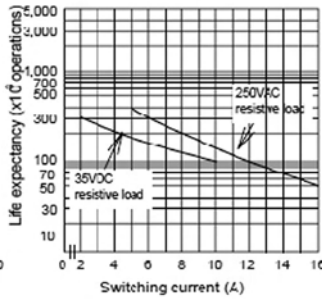

Ambient Temp. Vs Max. Voltage

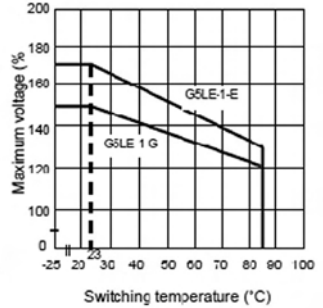

Note: The maximum coil voltage refers to the maximum value in a varying range of operating power voltage not a continuous voltage

Dimensions

Note: 1. All units are in millimetres unless otherwise indicated.

2. Orientation marks are indicated as follows:  

**G5LE-1
G5LE-14
G5LE-1-E
G5LE-1-G**

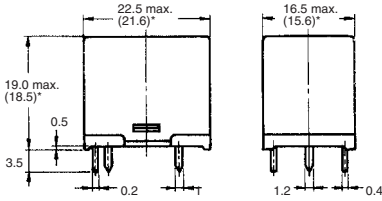
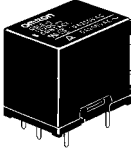

*Average value

**G5LE-1A
G5LE-1A4
G5LE-1A-E
G5LE-1A-G**

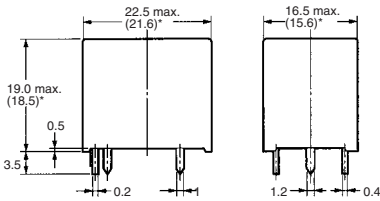
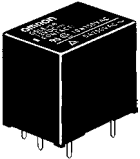

*Average value

Terminal Arrangement/Internal Connections (Bottom View)

SPDT

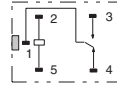

Mounting Holes (Bottom View)

Tolerance: ± 0.1 mm unless specified

SPDT

Five, $1.3^{+0.2}$ dia. holes

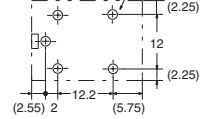

Terminal Arrangement/Internal Connections (Bottom View)

SPST-NO

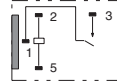

Mounting Holes (Bottom View)

Tolerance: ± 0.1 mm unless specified

SPST-NO

Four, $1.3^{+0.2}$ dia. holes

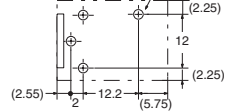

ALL DIMENSIONS SHOWN ARE IN MILLIMETRES.

To convert millimetres into inches, multiply by 0.03937. To convert grams into ounces, multiply by 0.03527.