

Subminiature Relay that Switches up to 5 A

- Subminiature: 20 × 10 × 10 mm (L × W × H).
- Low power consumption: 200 mW.
- Unique moving loop armature reduces relay size, magnetic interference, and contact bounce time.
- Single- and double-winding latching types also available.

RoHS Compliant Refer to pages 16 to 17 for details.

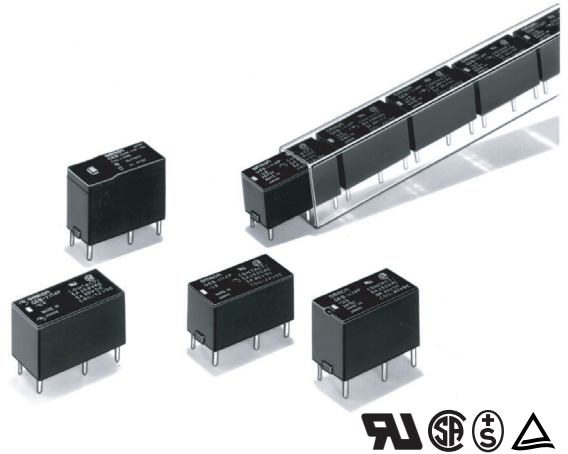

Ordering Information

Classification	Contact form	Straight PCB	Self-clinching PCB
Single-side stable	SPST-NO	G6B-1114P-US	G6B-1114C-US
	SPST-NO+SPST-NC	G6B-2114P-US	G6B-2114C-US
	DPST-NO	G6B-2214P-US	G6B-2214C-US
	DPST-NC	G6B-2014P-US	G6B-2014C-US
Single-winding latching	SPST-NO	G6BU-1114P-US	G6BU-1114C-US
Double-winding latching	SPST-NO	G6BK-1114P-US	G6BK-1114C-US
High-capacity single-side stable	SPST-NO	G6B-1174P-US	G6B-1174C-US

Note: When ordering, add the rated coil voltage to the model number.
Example: G6B-1114P-US 12 VDC

Rated coil voltage

Model Number Legend

G6B - - VDC
 1 2 3 4 5 6 7

1. Relay Function

None: Single-side stable
 U: Single-winding latching
 K: Double-winding latching

2. Contact Form

21: SPST-NO + SPST-NC
 22: DPST-NO
 20: DPST-NC
 11: SPST-NO

3. Contact Type

1: Standard
 7: High-capacity

4. Enclosure Ratings

4: Fully sealed

5. Terminals

P: Straight PCB
 C: Self-clinching PCB

6. Approved Standards

US: UL/CSA certified

7. Rated Coil Voltage

5, 6, 12, 24 VDC

■ Accessories (Order Separately)

Back Connecting Sockets

Applicable relay	Back connecting socket*
G6B(U)-1114P-US	P6B-04P
G6BK-1114P-US	P6B-06P
G6B-2□□4P-US-P6B	P6B-26P
G6B-1174P-US	P6B-04P

*Not applicable to the self-clinching type.

Removal Tool	P6B-Y1
Hold-down Clips	P6B-C2

Specifications

■ Coil Ratings

Single-side Stable Type

Item	SPST-NO				SPST-NO + SPST-NC, DPST-NO, DPST-NC			
	5	6	12	24	5	6	12	24
Rated voltage (VDC)	5	6	12	24	5	6	12	24
Rated current (mA)	40	33.3	16.7	8.3	60	50	25	12.5
Coil resistance (Ω)	125	180	720	2,880	83.3	120	480	1,920
Coil inductance (H) (ref. value)	Armature OFF	0.28	0.31	1.2	4.9	---	---	---
	Armature ON	0.26	0.28	1.1	4.1	---	---	---
Must operate voltage	70% max. of rated voltage				80% max. of rated voltage			
Must release voltage	10% min. of rated voltage							
Max. voltage	160% of rated voltage (at 23°C)				140% of rated voltage (at 23°C)			
Power consumption	Approx. 200 mW				Approx. 300 mW			

Single-winding Latching Type

Rated voltage	5 VDC	6 VDC	12 VDC	24 VDC
Rated current	40 mA	33.3 mA	16.7 mA	8.3 mA
Coil resistance	125 Ω	180 Ω	720 Ω	2,880 Ω
Coil inductance (H) (ref. value)	Armature OFF	0.28	0.31	1.2
	Armature ON	0.26	0.28	1.1
Must operate voltage	70% max. of rated voltage			
Must release voltage	70% min. of rated voltage			
Max. voltage	160% of rated voltage (at 23°C)			
Power consumption	Approx. 200 mW			

Double-winding Latching Type

Rated voltage	5 VDC	6 VDC	12 VDC	24 VDC		
Set coil	Rated current	56 mA	46.8 mA	23.3 mA	11.7 mA	
	Coil resistance	89.2 Ω	128.5 Ω	515 Ω	2,060 Ω	
	Coil inductance (H) (ref. value)	Armature OFF	0.15	0.18	0.52	1.2
		Armature ON	0.15	0.18	0.52	1.2
Reset coil	Rated current	56 mA	46.8 mA	23.3 mA	11.7 mA	
	Coil resistance	89.2 Ω	128.5 Ω	515 Ω	2,060 Ω	
	Coil inductance (H) (ref. value)	Armature OFF	0.15	0.18	0.52	1.2
		Armature ON	0.15	0.18	0.52	1.2
Must set voltage	70% max. of rated voltage					
Must reset voltage	70% min. of rated voltage					
Max. voltage	130% of rated voltage (at 23°C)					
Power consumption	Set coil: Approx. 280 mW Reset coil: Approx. 280 mW					

Note: 1. The rated current and coil resistance are measured at a coil temperature of 23°C with a tolerance of ±10%.
2. Operating characteristics are measured at a coil temperature of 23°C.

■ Contact Ratings

Item	SPST-NO		SPST-NO + SPST-NC, DPST-NO, DPST-NC	
	Resistive load ($\cos\phi = 1$)	Inductive load ($\cos\phi = 0.4$; L/R = 7 ms)	Resistive load ($\cos\phi = 1$)	Inductive load ($\cos\phi = 0.4$; L/R = 7 ms)
Rated load	5 A at 250 VAC; 5A at 30 VDC	2 A at 250 VAC; 2 A at 30 VDC	5 A at 250 VAC; 5A at 30 VDC	1.5 A at 250 VAC; 1.5 A at 30 VDC
Contact material	Ag Alloy (Cd free)			
Rated carry current	5 A			
Max. switching voltage	380 VAC, 125 VDC			
Max. switching current	5 A			
Max. switching power	1,250 VA, 150 W	500 VA, 60 W	1,250 VA, 150 W	375 VA, 80 W
Failure rate (reference value)	10 mA at 5 VDC			

Item	SPST-NO (High-capacity)	
	Resistive load ($\cos\phi = 1$)	Inductive load ($\cos\phi = 0.4$; L/R = 7 ms)
Rated load	8 A at 250 VAC; 8 A at 30 VDC	2 A at 250 VAC; 2 A at 30 VDC
Contact material	Ag Alloy (Cd free)	
Rated carry current	8 A	
Max. switching voltage	380 VAC, 125 VDC	
Max. switching current	8 A	
Max. switching power	2,000 VA, 150 W	
Failure rate (reference value)	10 mA at 5 VDC	

Note: P level: $\lambda_{60} = 0.1 \times 10^{-6}$ /operation

■ Characteristics

Contact resistance	30 m Ω max.
Operate (set) time	10 ms max. (mean value: 1-pole approx. 3 ms, 2-pole approx. 4 ms)
Release (reset) time	Single-side stable types: 10 ms max. (mean value: 1-pole approx. 1 ms, 2-pole approx. 2 ms) Latching types: 10 ms max. (mean value: approx. 3 ms)
Min. set/reset signal width	Latching type: 15 ms min. (at 23°C)
Max. operating frequency	Mechanical: 18,000 operations/hr Electrical: 1,800 operations/hr (under rated load)
Insulation resistance	1,000 M Ω min. (at 500 VDC, at 250 VDC between set coil and reset coil)
Dielectric strength	3,000 VAC (Latching types: 2,000 VAC), 50/60 Hz for 1 min between coil and contacts 1,000 VAC, 50/60 Hz for 1 min between contacts of same polarity 250 VAC, 50/60 Hz for 1 min between set and reset coils 2,000 VAC, 50/60 Hz for 1 min between contacts of different polarity
Vibration resistance	Destruction: 10 to 55 to 10 Hz, 0.75-mm single amplitude (1.5-mm double amplitude) Malfunction: 10 to 55 to 10 Hz, 0.75-mm single amplitude (1.5-mm double amplitude)
Shock resistance	Destruction: 1,000 m/s ² Malfunction: Single-side stable: 100 m/s ² ; Latching: 300 m/s ²
Endurance	Mechanical: 50,000,000 operations min. (at 18,000 operations/hr) Electrical: 100,000 operation min. (at 1,800 operations/hr)
Ambient temperature	Operating: -25°C to 70°C (with no icing)
Ambient humidity	Operating: 5% to 85%
Weight	Double-winding latching: Approx. 3.7 g High-capacity: Approx. 4.6 g Double pole: Approx. 4.5 g Other: Approx. 3.5 g

Note: The data shown above are initial values.

■ Approved Standards

UL508 (File No. E41643)/CSA C22.2 No.14 (File No. LR31928)

Model	Contact form	Coil rating	Contact rating
G6B-1114P-US G6B-1114C-US G6BU-1114P-US G6BU-1114C-US G6BK-1114C-US G6BK-1114C-US	SPST-NO	3 to 24 VDC	5 A, 250 VAC (general use) 5 A, 30 VDC (resistive load)
G6B-1174P-US G6B-1174C-US			8 A, 250 VAC (general use) 8 A, 30 VDC (resistive load)
G6B-2114P-US G6B-2114C-US G6B-2214P-US G6B-2214C-US G6B-2014P-US G6B-2014C-US	SPST-NO + SPST-NC DPST-NO DPST-NC		5 A, 250 VAC (general use) 5 A, 30 VDC (resistive load)

Engineering Data

G6B-1114P-US

Maximum Switching Power

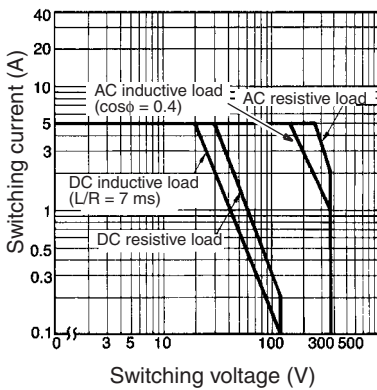

Endurance

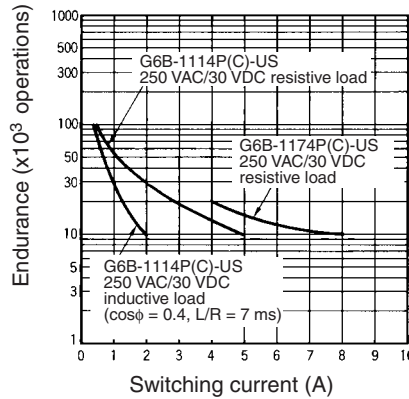

Ambient Temperature vs. Maximum Coil Voltage

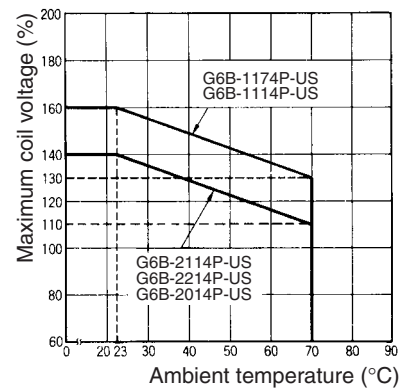

Note: The maximum coil voltage refers to the maximum value in a varying range of operating power voltage, not a continuous voltage.

G6B-2114P-US, G6B-2214P-US
G6B-2014P-US

Maximum Switching Power

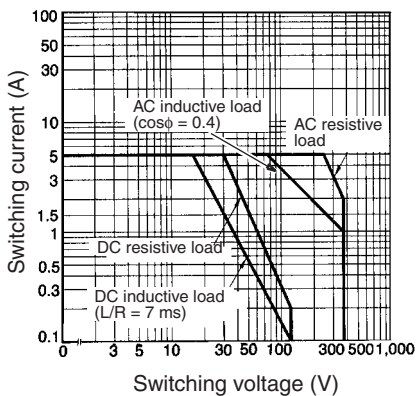

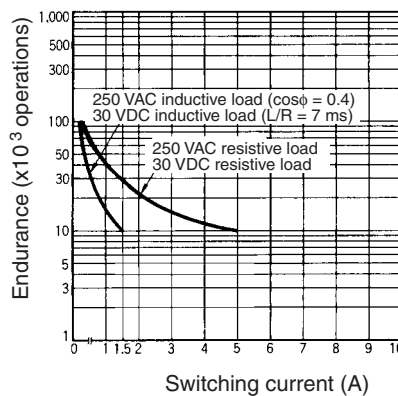

Endurance



Dimensions

Note: 1. All units are in millimeters unless otherwise indicated.

2. Orientation marks are indicated as follows:  

G6B-1114P-US G6BU-1114P-US

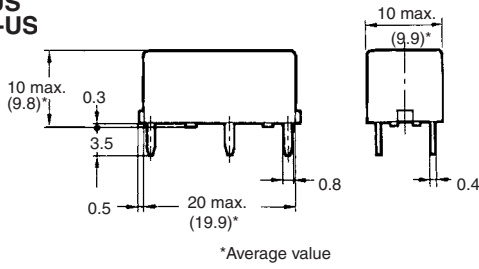
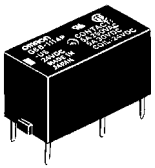

Terminal Arrangement/Internal Connections (Bottom View)
G6B-1114P, -1114C

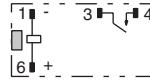

Mounting Holes (Bottom View)
G6B-1114P, -1114C
G6BU-1114P, -1114C

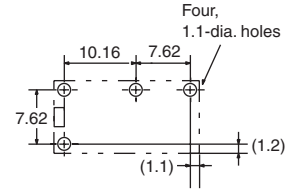

G6B-1114C-US G6BU-1114C-US

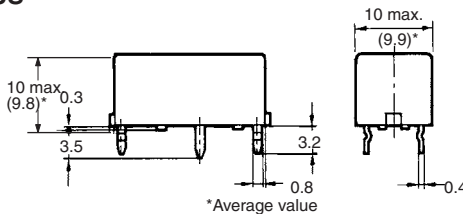
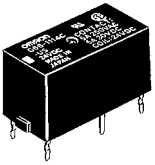

G6BU-1114P, -1114C

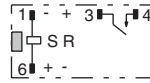

G6BK-1114P-US

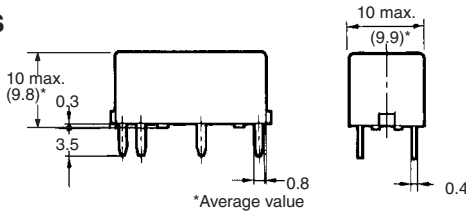
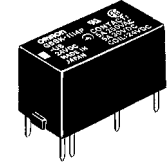

Terminal Arrangement/Internal Connections (Bottom View)
G6BK-1114P, -1114C

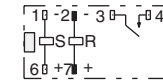

Mounting Holes (Bottom View)
G6BK-1114P, -1114C

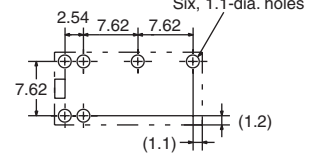

G6BK-1114C-US

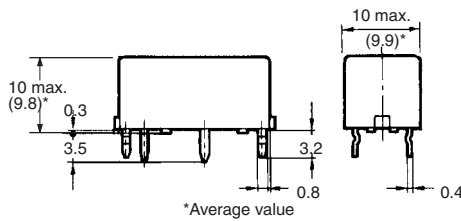
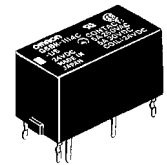

G6B-1174P-US

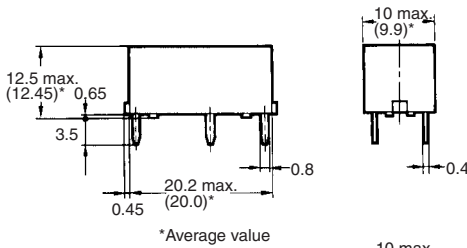
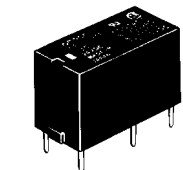

Terminal Arrangement/Internal Connections (Bottom View)
G6B-1174P, -1174C

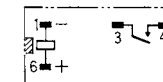

Mounting Holes (Bottom View)

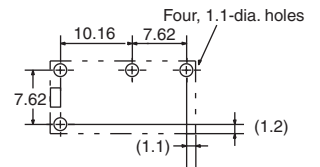

G6B-1174C-US

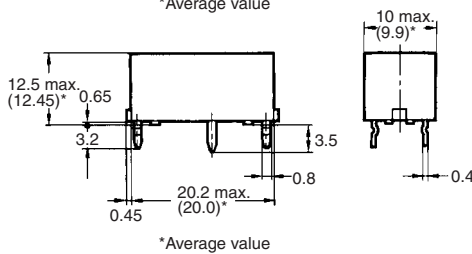
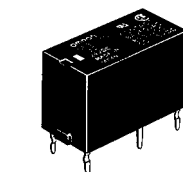

G6B-2114P-US
G6B-2214P-US
G6B-2014P-US

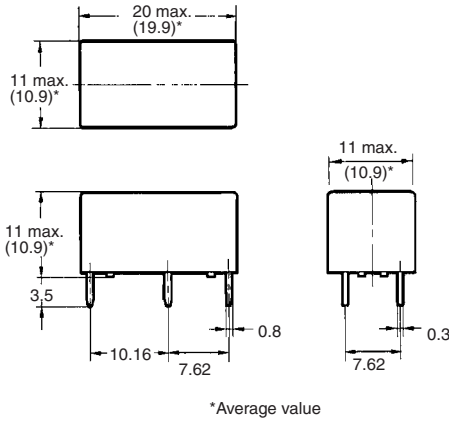
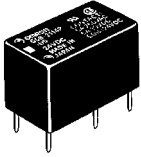

Terminal Arrangement/Internal Connections (Bottom View)

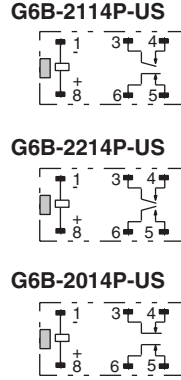

Mounting Holes (Bottom View)
Tolerance: ± 0.1

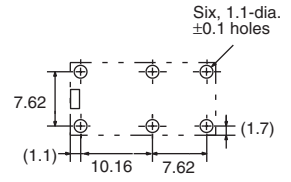

G6B-2114C-US
G6B-2214C-US
G6B-2014C-US

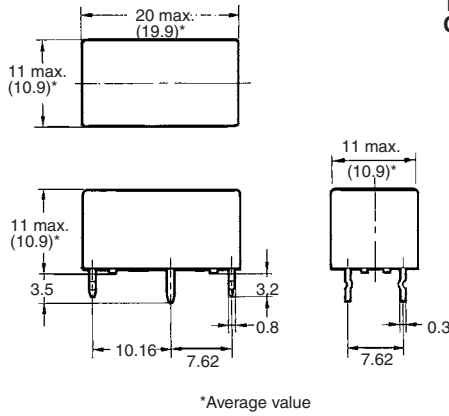
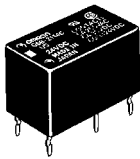

Terminal Arrangement/Internal Connections (Bottom View)

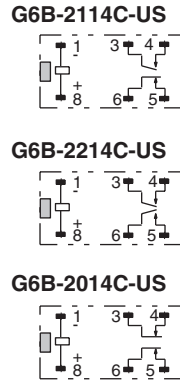

Mounting Holes (Bottom View)
Tolerance: ± 0.1

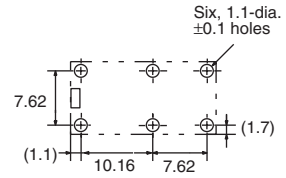

Back Connecting Socket
P6B-04P

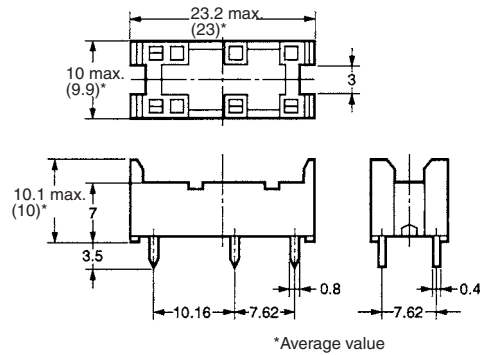
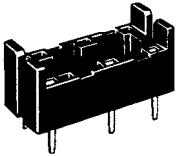

Mounting Holes (Bottom View)

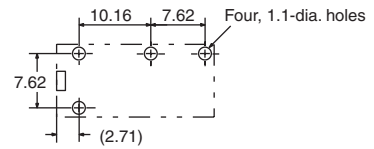

P6B-06P

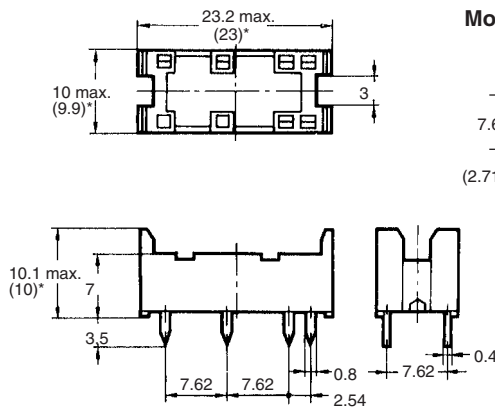
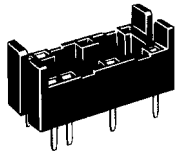

*Average value

Mounting Holes (Bottom View)

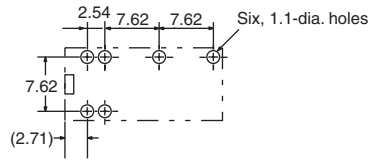

P6B-26P

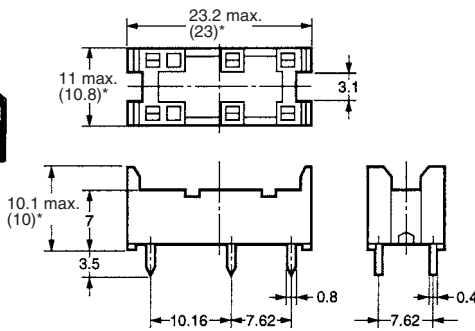
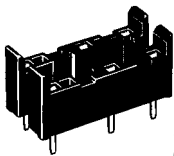

*Average value

Mounting Holes (Bottom View)

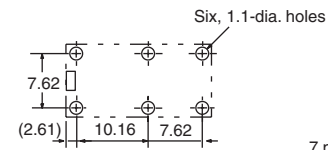

Note: Rated current of socket is 5 A max.

Mounting Height of Relay with Connecting Socket

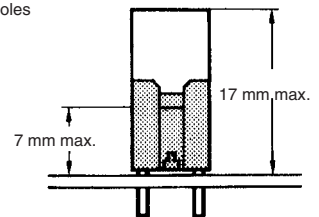

Note: Height of G6B-1174P-US is 19.5 mm max.

**Removal Tool
P6B-Y1**

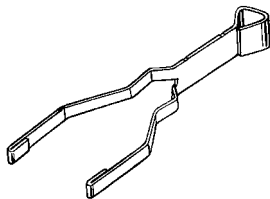

**Hold-down Clips
P6B-C2**

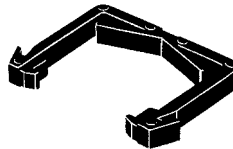

Note: P6B-C2 Hold-down Clips cannot be used for G6B-1174P-US.

ALL DIMENSIONS SHOWN ARE IN MILLIMETERS.

To convert millimeters into inches, multiply by 0.03937. To convert grams into ounces, multiply by 0.03527.