

PCB Relay

G6D

Slim, Miniature Relay (17.5 x 6.5 x 12.5 (L x W x H)), Capable of Relaying Programmable Controller and Temperature Controller Outputs

- Reduced bottom area (45% smaller than the G6B's bottom area) ideal for high-density mounting.
- Switches 5 A at 250 VAC/30 VDC.
- Allows 300,000 operations with a 2-A load at 250 VAC or 30 VDC.
- Actual load switching capability equals the G6B's capability.
- Washable construction.



Ordering Information

Contact form	Model
SPST-NO	G6D-1A

Note: When ordering, add the rated coil voltage to the model number.

Example: G6D-1A 12 VDC
└─── Rated coil voltage

Classification

Contact form: SPST-NO
 Enclosure: Plastic sealed
 Terminal: PCB terminal

Model Number Legend:

G6D - VDC
1 2 3

- | | | |
|-----------------------------------------------------------------|------------------------------------------------------------------------|--|
| <p>1. Number of Poles
 1: 1 pole</p> | <p>3. Rated Coil Voltage
 5, 12, 24 VDC</p> | |
| <p>2. Contact Form
 A: SPST-NO</p> | | |

■ Accessories (Order Separately)

Connecting Socket	P6D-04P
-------------------	---------

Specifications

■ Coil Ratings

Rated voltage	5 VDC	12 VDC	24 VDC
Rated current	40 mA	16.7 mA	8.3 mA
Coil resistance	125 Ω	720 Ω	2,880 Ω
Must operate voltage	70% max. of rated voltage		
Must release voltage	10% min. of rated voltage		
Max. voltage	130% of rated voltage		
Power consumption	Approx. 200 mW		

Note: The must operate voltage is 75% or less of the rated voltage if the relay is mounted upside down.

■ Contact Ratings

Load	Resistive load ($\cos\phi = 1$)
Rated load	5 A at 250 VAC, 5 A at 30 VDC
Rated carry current	5 A
Max. switching voltage	250 VAC, 30 VDC
Max. switching current	5 A
Max. switching capacity	1,250 VA, 150 W
Min. permissible load	10 mA at 5 VDC

Note: P level: $\lambda_{60} = 0.1 \times 10^{-6}/\text{operation}$

■ Characteristics

Contact resistance	100 m Ω max.
Operating time	10 ms max.
Release time	5 ms max.
Insulation resistance	1,000 M Ω min. (at 500 VDC)
Dielectric strength	3,000 VAC, 50/60 Hz for 1 min between coil and contacts 750 VAC, 50/60 Hz for 1 min between contacts of same polarity
Impulse withstand voltage	6,000 V 1.2 x 50 μ s (between coil and contacts)
Vibration resistance	Destruction: 10 to 55 Hz, 1.5-mm double amplitude Malfunction: 10 to 55 Hz, 1.5-mm double amplitude
Shock resistance	Destruction: 1,000 m/s ² (approx. 100G) Malfunction: 100 m/s ² (approx. 10G)
Life expectancy	Mechanical: 20,000,000 operations min. (at 18,000 operations/hr) Electrical: 100,000 operations min. (5 A at 250 VAC/30 VDC, resistive load) 300,000 operations min. (2 A at 250 VAC/30 VDC, resistive load)
Ambient temperature	Operating: -25°C to 70°C (with no icing) Storage: -25°C to 70°C (with no icing)
Ambient humidity	Operating: 35% to 85% Storage: 35% to 85%
Weight	Approx. 3 g

■ Approved Standards

UL508 (File No. E41515)/CSA C22.2 No.14 (File No. LR31928)

Model	Coil ratings	Contact ratings
G6D-1A	5 to 24 VDC	5 A, 250 VAC 5 A, 30 VDC

Engineering Data

Max. Switching Capacity

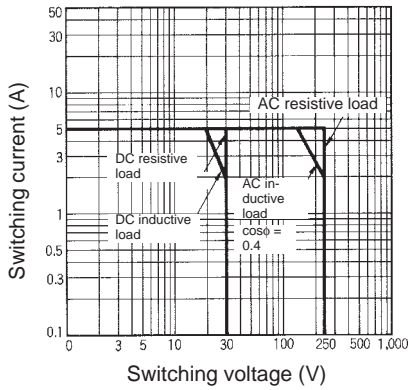

Life Expectancy

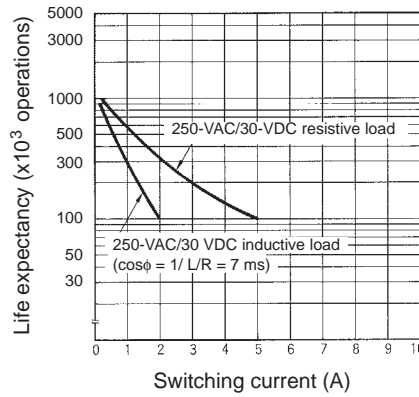

Ambient Temperature vs. Maximum Voltage

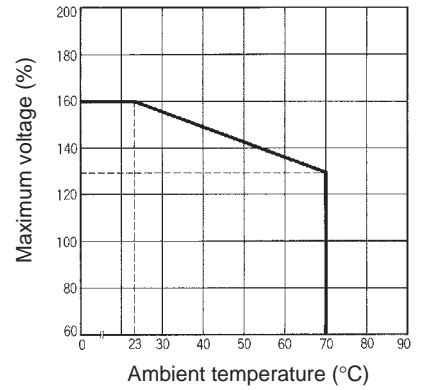

Reference Data

Electrical Life Expectancy

5 A at 250 VAC, $\cos\phi = 1$

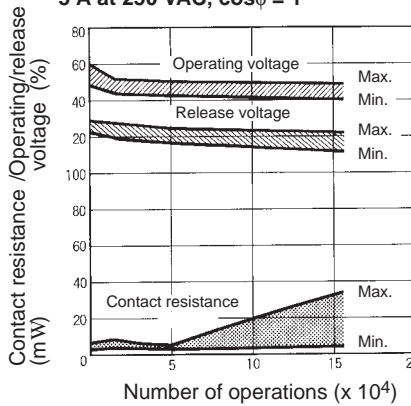

5 A at 30 VDC, Resistive Load

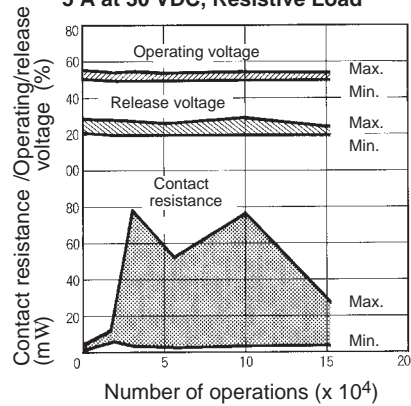

2 A at 30 VDC, Resistive Load

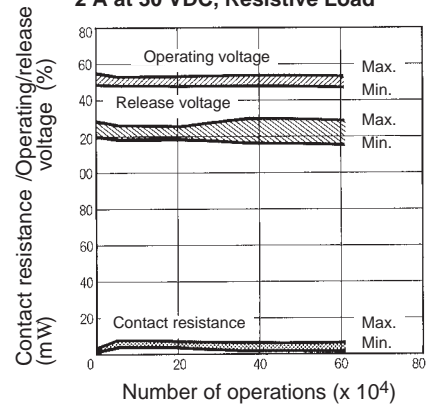

Electrical Life Expectancy

2 A at 250 VAC, $\cos\phi = 1$

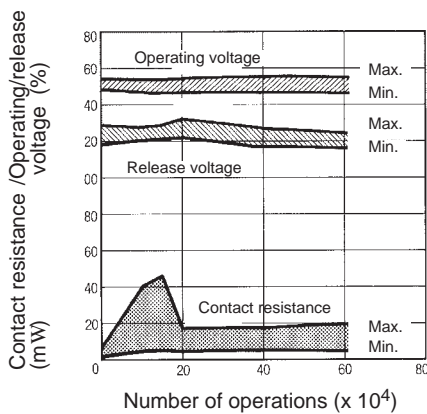

Actual Load Test Data

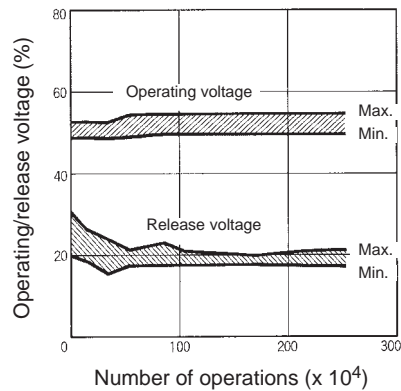

With OMRON's H3BA Timer (5 mA at 200 VAC)

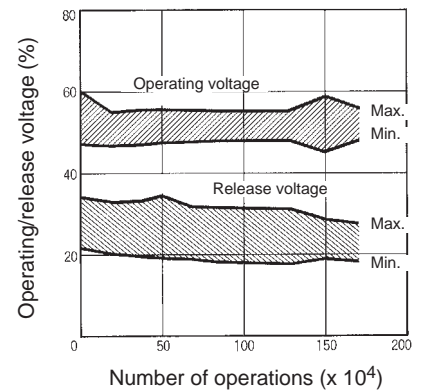

With OMRON's MA415A Contactor (40 mA at 200 VAC)



Dimensions

- Note:** 1. All units are in millimeters unless otherwise indicated.
 2. Orientation marks are indicated as follows:  

G6D-1A

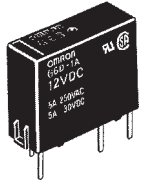

*Average value

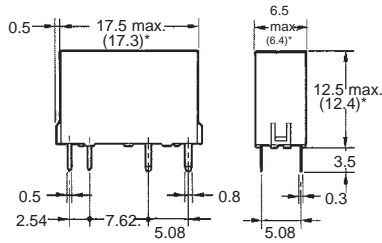

Terminal Arrangement/ Internal Connections (Bottom View)

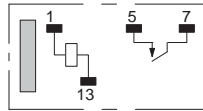

Mounting Holes (Bottom View)

Tolerance: ± 0.1

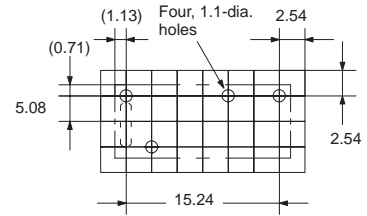

P6D-04P Socket

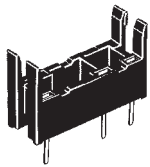

*Average value

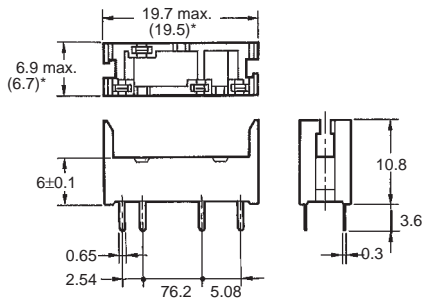

Mounting Holes (Bottom View)

Tolerance: ± 0.1

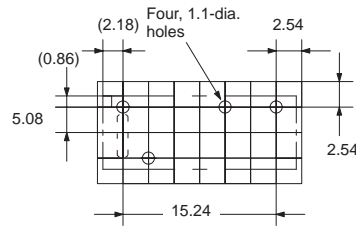

Precautions

More than two relays can be closely mounted right side up as shown in the following illustration.

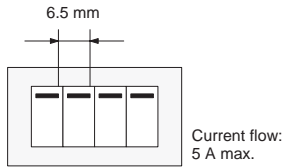

More than two relays can be closely mounted upside down as shown in the following illustration.

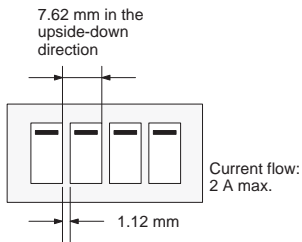

Note: The space between each relay required for heat radiation may vary with operating conditions. Contact your OMRON representative for details.

Socket Mounting Height

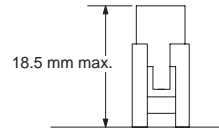

When mounting the relay, insert it into the socket as vertically as possible so that the relay terminals contact securely with the contact pins on the socket.

The P6D is flux-resistant. Do not wash the P6D with water.

Dismount the relay from the socket before soldering the socket to a PCB.

ALL DIMENSIONS SHOWN ARE IN MILLIMETERS.

To convert millimeters into inches, multiply by 0.03937. To convert grams into ounces, multiply by 0.03527.