

Heavy-duty Miniature Relay

- ROHS compliant.
- Incorporates environment-friendly, cadmium-free contacts.
- Variety of contact forms: SPDT or SPST-NO (continuous current rating: 8 A)
- Dielectric strength of 4 kV at a distance of 8 mm.
- Tracking resistance: CTI>250
- Conforms to EN 61810-1.



Ordering Information

Classification	Enclosure ratings	Contact material	Contact form	
			SPST-NO	SPDT
Standard	Fully sealed	AgNi + gold plating (0.35 μ)	G6RN-1A	G6RN-1
		AgNi	G6RN-1A-ANI	G6RN-1-ANI
		AgNi + gold plating (4 μ)	G6RN-1A-AP4	G6RN-1-AP4

Note: When ordering, add the rated coil voltage to the model number.

Example: G6RN-1A 24 VDC
└───┘ Rated coil voltage

Model Number Legend

G6RN-□□-□□ VDC
1 2 3 4

1. Number of Poles

1: 1 pole

2. Contact Form

None: SPDT
 A: SPST-NO

3. Contact Material

None: AgNi + gold plating (0.35 μ)
 ANI: AgNi
 AP4: AgNi + gold plating (4 μ)

4. Rated Coil Voltage

5, 12, 24, 48 VDC

Specifications

■ Coil Ratings

Rated voltage	5 VDC	12 VDC	24 VDC	48 VDC
Rated current	44 mA	18.3 mA	9.2 mA	5.2 mA
Coil resistance	114 Ω	655 Ω	2,620 Ω	9,210 Ω
Must operate voltage	70% max. of rated voltage			
Must release voltage	10% min. of rated voltage			
Max. voltage	110% of rated voltage at max. temperature (at 85°C)			
Power consumption	Approx. 220 mW		Approx. 250 mW	

Note: 1. The rated current and coil resistance are measured at a coil temperature of 23°C with a tolerance of ±10%.
2. Operating characteristics are measured at a coil temperature of 23°C..

■ Contact Ratings

Load	Resistance load ($\cos\phi = 1$)
Rated load	8 A at 250 VAC; 5 A at 30 VDC
Rated carry current	8 A
Max. switching voltage	250 VAC; 30 VDC, (400 VAC) (see note)
Max. switching current	AC 8 A; DC 5 A
Max. switching power	2,000 VA; 150 W
Failure rate (reference value)	5 VDC 10 mA (for gold plating 0.35 μ min.)

Note: Electrical life expectancy is reduced.

■ Characteristics

Operate time	Approx. 6 ms
Release time	Approx. 3 ms
Max. operating frequency	Mechanical: 36,000 operations/hr Electrical: 360 operations/hr (under rated load)
Insulation resistance	1,000 MΩ min. (at 500 VDC)
Dielectric strength	4,000 VAC between coil and contacts 1,000 VAC between contacts
Creepage/clearance	8 mm min. between coil and contacts
Vibration resistance	Malfunction: NO: 10 to 55 to 10 Hz, 0.75mm single amplitude (1.5mm double amplitude) NC: 10 to 55 to 10 Hz, 0.4mm single amplitude (0.8mm double amplitude)
Shock resistance	Destruction: 1,000 m/s ²
Endurance	Mechanical: 10,000,000 operations min. Electrical: Approx. 100,000 operations
Ambient temperature	Operating: -40°C to 85°C (with no icing)
Ambient humidity	Operating: 5% to 85%
Weight	Approx. 9 g
Protection class	II according to VDE0106 Part 1
Insulation class	C/250, B/380 according to VDE0110

■ Approved Standards

EC255 (Includes Reinforced Insulation and Spacing Requirements According to IEC65, 335-1, 950, EN60335-1, 60950)

Standard	Contact form	Coil ratings	Contact rating	Conditions
IEC255-1-00 IEC255-0-20	SPDT SPST-NO	5, 6, 12, 18, 24 36, 48 VDC	8A at 250 VAC ($\cos\phi = 1$) (see note)	Pollution: degree: 3 Overvoltage category: II Operating range: class 1 Pick-up class: class C Ambient temperature: -40°C to 85°C

■ EN 61810-1 (VDE Reg. no 0435 part no 201 & 102/Reg. no 6135)

Standard	Contact form	Coil ratings	Contact rating	Conditions
VDE0435 Part201 VDE0435 Part120 EN 61810	SPDT SPST-NO	5, 6, 12, 18, 24 36, 48 VDC	8 A at 250 VAC ($\cos\phi = 1$)	Insulation group according to VDE0110 C/250, B/380 Operating range: class 1 Pick-up class: class C Ambient temperature: -40°C to 85°C

■ UL508 (File No. E41515)

Coil ratings	Contact ratings
5 to 48 VDC	10 A at 250 VAC (resistive) 5 A at 30 VDC (resistive) 8 A at 250 VAC (resistive) (ambient temperature: 85°C)

■ CSA C22.2 (File No. LR31928-543)

Coil ratings	Contact ratings
5 to 48 VDC	10 A at 250 VAC (resistive) 5 A at 30 VDC (resistive) 8 A at 250 VAC (resistive) (ambient temperature: 85°C)

Engineering Data

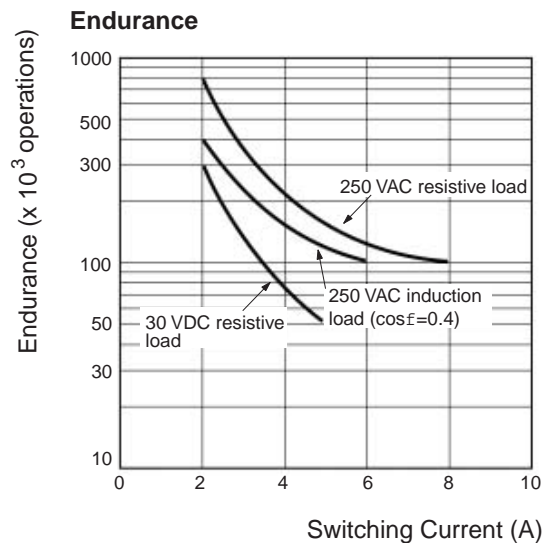
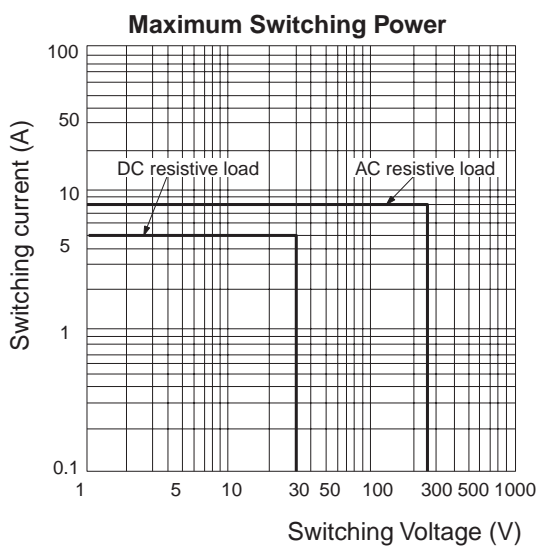

Engineering Data

Ambient Temperature vs Maximum Coil Voltage

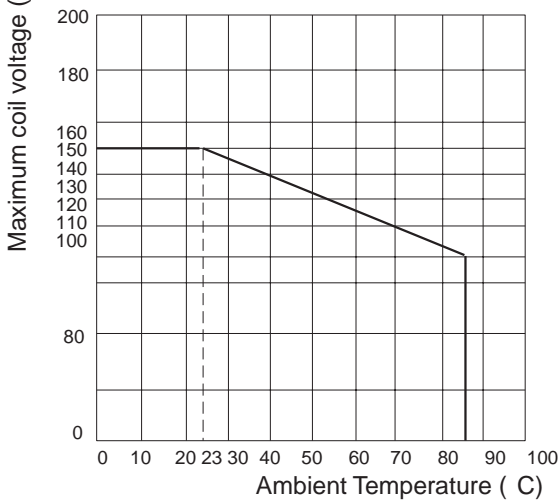

Note: The maximum coil voltage refers to the maximum value in a varying range of operating power voltage, not a continuous voltage.

SPDT Type

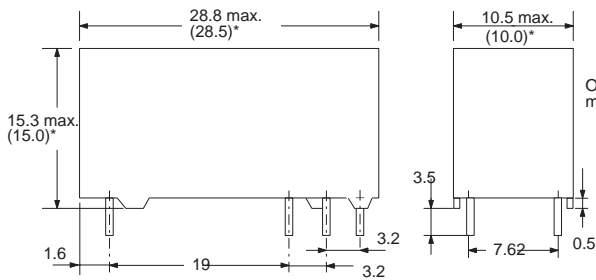

*Average value.

Terminal Arrangement/ Internal Connections (Bottom View)

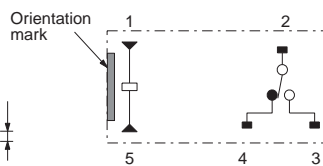

Mounting Holes (Bottom View)

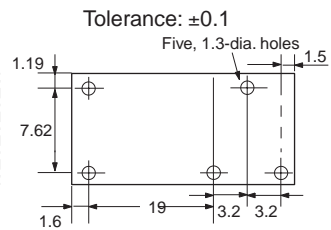

SPST-NO Type

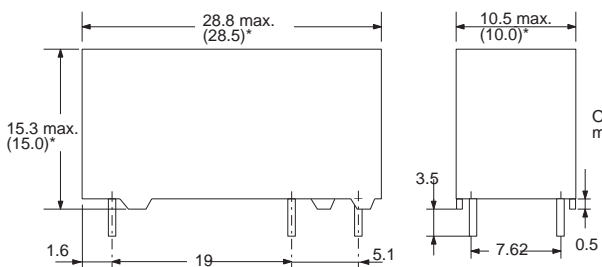
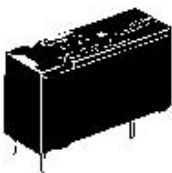

*Average value.

Terminal Arrangement/ Internal Connections (Bottom View)

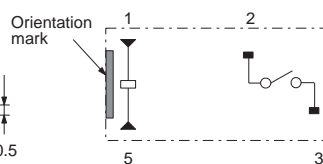

Mounting Holes (Bottom View)

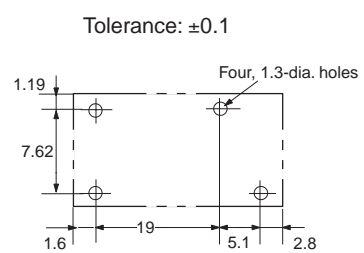

ALL DIMENSIONS SHOWN ARE IN MILLIMETERS.

To convert millimeters into inches, multiply by 0.03937. To convert grams into ounces, multiply by 0.03527.