

Data sheet | Item number: 286-834

Surge suppression module for signal technology; Nominal voltage: 12 VDC;
for 2 signal paths with common surge arrester; pluggable on rail-mount
terminal block, 20 mm wide

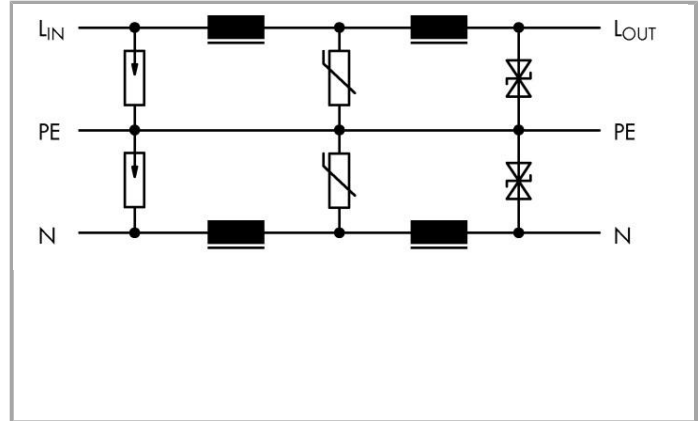

www.wago.com/286-834



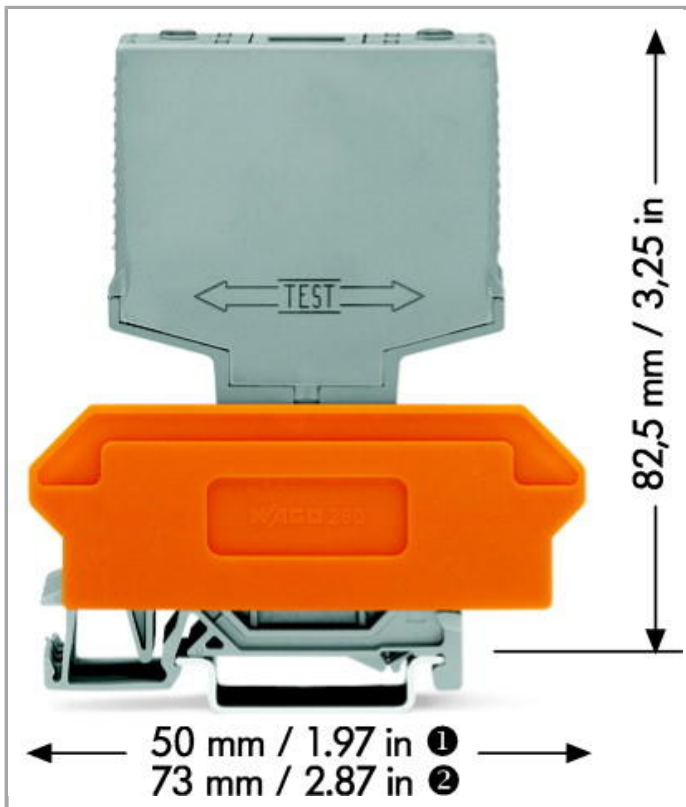

Item description

Short description:

Two- and three-stage pluggable surge suppression modules (286 Series) for data, measurement, control, or power circuits are also available.

Features:

- Protect your system against overvoltage
- Slim, space-saving design
- Control operational costs by preventing expensive, unplanned downtime
- High operational reliability and system uptime

Note:

For isolation measurement, the ground contact at the transient suppression module must be disconnected.

Data

Electrical data

Nominal operating voltage	12 VDC
Operating voltage	≤ 14 VDC
Nominal current	6 A
Nominal discharge current line/PG	1.5 kA
Max. surge current line/PG	1.5

Voltage protection level line/PG	≤ 22 V
Response time line/PG	≤ 25 ns

Safety and protection:

Rated voltage	250 V
Rated impulse voltage	4 kV
Pollution degree	3

Geometrical Data

Width	20 mm / 0.787 inch
Height from upper-edge of DIN-35 rail	82.5 mm / 3.25 inch
Depth	52 mm / 1.654 inch

Mechanical data

Type of mounting	Pluggable module for carrier terminal blocks
Housing design	Pluggable module for terminal blocks

Material Data

Color	gray
Weight	40.9 g

Environmental Requirements

Surrounding air (operating) temperature	-25 ... 85 °C
---	---------------

Commercial data

Country of origin	DE
GTIN	4017332158244
Customs Tariff No.	85366990990
Product Group	6 (Interface Electronics)

Compatible products

General accessories

Item no.: 280-628

Terminal block for pluggable modules; 16-pole; with 4-conductor terminal blocks; with orange separator; for DIN-rail 35 x 15 and 35 x 7.5; 2.5 mm²

www.wago.com/280-628

Item no.: 280-638

Terminal block for pluggable modules; 8-pole; with 2-conductor terminal blocks; with orange separator; for DIN-rail 35 x 15 and 35 x 7.5; 2.5 mm²















www.wago.com/280-638





Item no.: 280-764

Terminal block for pluggable modules; 16-pole; with 4-conductor terminal blocks; with marker carrier; with orange separator; for DIN-rail 35 x 15 and 35 x 7.5; 2.5 mm²

www.wago.com/280-764

Marking accessories

	Item no.: 209-700/209-124 WSB marking card; as card; MARKED; F11, ..., F20 (10x); not stretchable; Vertical marking; snap-on type	www.wago.com/209-700/209-124
	Item no.: 209-700/209-125 WSB marking card; as card; MARKED; F21, ..., F30 (10x); not stretchable; Vertical marking; snap-on type	www.wago.com/209-700/209-125
	Item no.: 209-700/209-126 WSB marking card; as card; MARKED; F31, ..., F40 (10x); not stretchable; Vertical marking; snap-on type	www.wago.com/209-700/209-126
	Item no.: 209-700/209-127 WSB marking card; as card; MARKED; not stretchable; Vertical marking; snap-on type	www.wago.com/209-700/209-127
	Item no.: 209-701 WSB marking card; as card; not stretchable; plain; snap-on type	www.wago.com/209-701
	Item no.: 209-701/000-002 WSB marking card; as card; not stretchable; plain; snap-on type	www.wago.com/209-701/000-002
	Item no.: 209-701/000-005 WSB marking card; as card; not stretchable; plain; snap-on type	www.wago.com/209-701/000-005
	Item no.: 209-701/000-006 WSB marking card; as card; not stretchable; plain; snap-on type	www.wago.com/209-701/000-006
	Item no.: 209-701/000-007 WSB marking card; as card; not stretchable; plain; snap-on type	www.wago.com/209-701/000-007
	Item no.: 209-701/000-012 WSB marking card; as card; not stretchable; plain; snap-on type	www.wago.com/209-701/000-012
	Item no.: 209-701/000-017 WSB marking card; as card; not stretchable; plain; snap-on type	www.wago.com/209-701/000-017
	Item no.: 209-701/000-023 WSB marking card; as card; not stretchable; plain; snap-on type	www.wago.com/209-701/000-023
	Item no.: 209-701/000-024 WSB marking card; as card; not stretchable; plain; snap-on type	www.wago.com/209-701/000-024
	Item no.: 209-702 WSB marking card; as card; MARKED; 1 ... 10 (10x); not stretchable; Vertical marking; snap-on type	www.wago.com/209-702
	Item no.: 209-703 WSB marking card; as card; MARKED; 11 ... 20 (10x); not stretchable; Vertical marking; snap-on type	www.wago.com/209-703

	Item no.: 209-704 WSB marking card; as card; MARKED; 21 ... 30 (10x); not stretchable; Vertical marking; snap-on type	www.wago.com/209-704
	Item no.: 209-705 WSB marking card; as card; MARKED; 31 ... 40 (10x); not stretchable; Vertical marking; snap-on type	www.wago.com/209-705
	Item no.: 209-706 WSB marking card; as card; MARKED; 41 ... 50 (10x); not stretchable; Vertical marking; snap-on type	www.wago.com/209-706
	Item no.: 209-707 WSB marking card; as card; MARKED; 51 ... 100 (2x); not stretchable; Vertical marking; snap-on type	www.wago.com/209-707

Downloads

Documentation

Additional Information

Disposal; Electrical and electronic equipment, Packaging	Oct 15, 2018	Download
		265.8 kB

Subject to changes.