

Data sheet | Item number: 788-700

Solid-state relay module; Nominal input voltage: 24 VDC; Output voltage range: 0 ... 24 VDC; Limiting continuous current: 3.5 A; 2-wire connection; Red status indicator; Module width: 15 mm

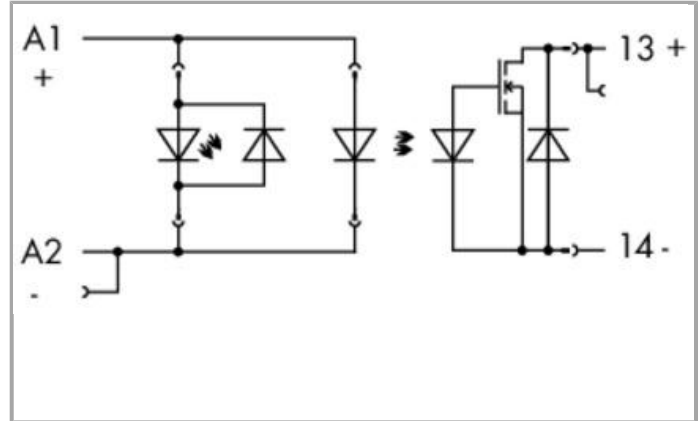

www.wago.com/788-700

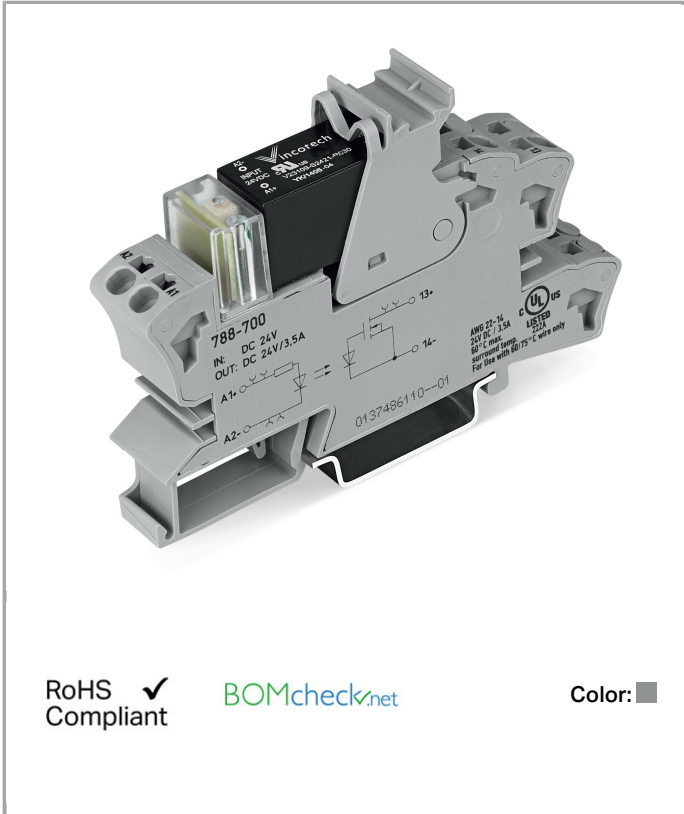

RoHS Compliant

[BOMcheck.net](https://www.bomcheck.net)

Color:

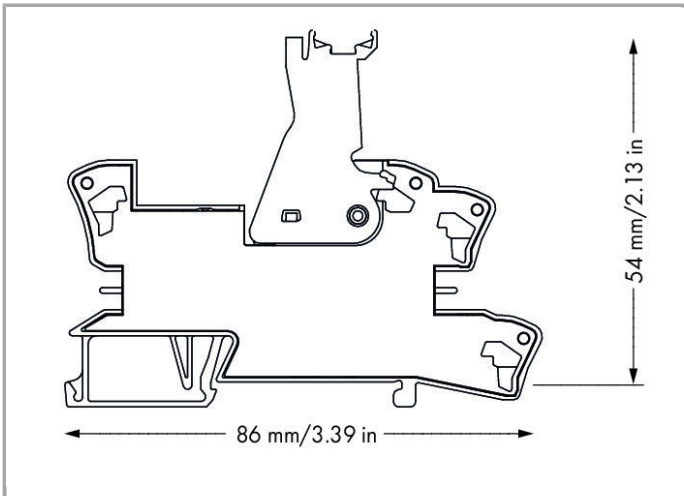

Item description

Note:

A separator plate (e.g., 209-191) must be used for voltages greater than 250 V between adjacent relay modules and for compliance with the reinforced insulation requirements.

Data

Technical Data

Control circuit

Nominal input voltage U_N	24 VDC
Input voltage range (low level)	0 ... 8 VDC
Input voltage range (high level)	18 ... 30 VDC
Nominal input current at U_N	7 mA

Load circuit:

Circuit type	2-conductor termination
Limiting continuous current	3.5 A
Output voltage range	0 ... 24 VDC
Max. voltage drop at output	≤ 0.1 VDC
Turn-on time	≤ 50 μ s
Drop-out time	≤ 600 μ s
Switching frequency	≤ 100 Hz

Signaling

Status indication	LED red
-------------------	---------

Safety and protection:

Pollution degree	2
Dielectric strength, control/load circuit (AC, 1 min)	2.5 kV _{rms}
Dielectric strength, control/load circuit (AC, 1 min)	2.5 kV _{rms}
Degree of protection	IP20

Connection data

Connection technology	Push-in CAGE CLAMP®
Solid conductor	0.34 ... 2.5 mm ² / 22 ... 14 AWG
Fine-stranded conductor	0.34 ... 2.5 mm ² / 22 ... 14 AWG
Strip length	9 ... 10 mm / 0.35 ... 0.39 Inch

Geometrical Data

Width	15 mm / 0.591 inch
Height from upper-edge of DIN-35 rail	54 mm / 2.126 inch
Depth	86 mm / 3.386 inch

Mechanical data

Type of mounting	DIN-35 rail
------------------	-------------

Material Data

Color	gray
Weight	41.7 g

Environmental Requirements

Surrounding air (operating) temperature at U_N	-20 ... 60 °C
Surrounding air (storage) temperature	-40 ... 70 °C
Pollution degree	2

Standards and specifications

Standards/specifications	EN 61000-6-2; EN 61000-6-3; EN 61373; EN 61010-2-201; UL 508
--------------------------	--

Commercial data

Country of origin	DE
GTIN	4045454743864
Customs Tariff No.	85365005000
Product Group	6 (Interface Electronics)

Approvals / Certificates

UL-Approvals

Logo	Approval	Certificate name
	UL UL International Netherlands B.V. (ORDINARY LOCATIONS)	E175199 Sec.6

Compatible products





tools







Item no.: 210-720
Operating tool with partially insulated shaft; Type 2, blade (3.5 x 0.5) mm

www.wago.com/210-720





Jumper

	Item no.: 788-118 Comb-style jumper bar; 2-way (1-3); insulated	www.wago.com/788-118
	Item no.: 859-402 Push-in type jumper bar; 2-way; Nominal current 18 A; insulated	www.wago.com/859-402
	Item no.: 859-402/000-005 Push-in type jumper bar; 2-way; Nominal current 18 A; insulated	www.wago.com/859-402/000-005
	Item no.: 859-402/000-006 Push-in type jumper bar; 2-way; Nominal current 18 A; insulated	www.wago.com/859-402/000-006
	Item no.: 859-402/000-029 Push-in type jumper bar; 2-way; Nominal current 18 A; insulated	www.wago.com/859-402/000-029

ferrule

















	Item no.: 216-241 Ferrule; Sleeve for 0.5 mm ² / AWG 22; insulated; electro-tin plated; electrolytic copper; gastight crimped; acc. to DIN 46228, Part 4/09.90	www.wago.com/216-241
	Item no.: 216-242 Ferrule; Sleeve for 0.75 mm ² / AWG 20; insulated; electro-tin plated; electrolytic copper; gastight crimped; acc. to DIN 46228, Part 4/09.90	www.wago.com/216-242
	Item no.: 216-243 Ferrule; Sleeve for 1 mm ² / AWG 18; insulated; electro-tin plated; electrolytic copper; gastight crimped; acc. to DIN 46228, Part 4/09.90	www.wago.com/216-243
	Item no.: 216-244 Ferrule; Sleeve for 1.5 mm ² / AWG 16; insulated; electro-tin plated; electrolytic copper; gastight crimped; acc. to DIN 46228, Part 4/09.90	www.wago.com/216-244
	Item no.: 216-542 Twin ferrule; Sleeve for 2 x 1 mm ² / AWG 2 x 18; red, insulated; 12 mm long	www.wago.com/216-542

General accessories

	Item no.: 209-145 Group marker carrier	www.wago.com/209-145
	Item no.: 209-184 Protection cover	www.wago.com/209-184
	Item no.: 249-105 Group marker carrier	www.wago.com/249-105
	Item no.: 788-120 Accessories for relay modules; Operation status indicator: red	www.wago.com/788-120

Marking accessories

	Item no.: 2009-110 Marking strips; on reel; not stretchable; plain; snap-on type	www.wago.com/2009-110
	Item no.: 2009-115	

	WMB-Inline; for smartPRINTER; on reel; stretchable 5 - 5.2 mm; plain; snap-on type	www.wago.com/2009-115
	Item no.: 2009-115/000-002 WMB-Inline; for smartPRINTER; on reel; stretchable 5 - 5.2 mm; plain; snap-on type	www.wago.com/2009-115/000-002
	Item no.: 2009-115/000-006 WMB-Inline; for smartPRINTER; on reel; stretchable 5 - 5.2 mm; plain; snap-on type	www.wago.com/2009-115/000-006
	Item no.: 2009-115/000-007 WMB-Inline; for smartPRINTER; on reel; stretchable 5 - 5.2 mm; plain; snap-on type	www.wago.com/2009-115/000-007
	Item no.: 2009-115/000-012 WMB-Inline; for smartPRINTER; on reel; stretchable 5 - 5.2 mm; plain; snap-on type	www.wago.com/2009-115/000-012
	Item no.: 2009-115/000-017 WMB-Inline; for smartPRINTER; on reel; stretchable 5 - 5.2 mm; plain; snap-on type	www.wago.com/2009-115/000-017
	Item no.: 2009-115/000-023 WMB-Inline; for smartPRINTER; on reel; stretchable 5 - 5.2 mm; plain; snap-on type	www.wago.com/2009-115/000-023
	Item no.: 209-128 Adaptor	www.wago.com/209-128
	Item no.: 209-183 Marker card	www.wago.com/209-183
	Item no.: 210-110 Fiber-tip pen	www.wago.com/210-110
	Item no.: 793-501 WMB marking card; as card; not stretchable; plain; snap-on type	www.wago.com/793-501
	Item no.: 793-501/000-002 WMB marking card; as card; not stretchable; plain; snap-on type	www.wago.com/793-501/000-002
	Item no.: 793-501/000-005 WMB marking card; as card; not stretchable; plain; snap-on type	www.wago.com/793-501/000-005
	Item no.: 793-501/000-006 WMB marking card; as card; not stretchable; plain; snap-on type	www.wago.com/793-501/000-006
	Item no.: 793-501/000-007 WMB marking card; as card; not stretchable; plain; snap-on type	www.wago.com/793-501/000-007
	Item no.: 793-501/000-012 WMB marking card; as card; not stretchable; plain; snap-on type	www.wago.com/793-501/000-012



Item no.: 793-501/000-017
WMB marking card; as card; not stretchable; plain; snap-on type

www.wago.com/793-501/000-017



Item no.: 793-501/000-023
WMB marking card; as card; not stretchable; plain; snap-on type

www.wago.com/793-501/000-023



Item no.: 793-501/000-024
WMB marking card; as card; not stretchable; plain; snap-on type

www.wago.com/793-501/000-024



Item no.: 793-502
WMB marking card; as card; MARKED; 1 ... 10 (10x); not stretchable; Horizontal marking; snap-on type

www.wago.com/793-502



Item no.: 793-502/000-002
WMB marking card; as card; MARKED; 1 ... 10 (10x); not stretchable; Horizontal marking; snap-on type

www.wago.com/793-502/000-002



Item no.: 793-502/000-005
WMB marking card; as card; MARKED; 1 ... 10 (10x); not stretchable; Horizontal marking; snap-on type

www.wago.com/793-502/000-005



Item no.: 793-502/000-006
WMB marking card; as card; MARKED; 1 ... 10 (10x); not stretchable; Horizontal marking; snap-on type

www.wago.com/793-502/000-006



Item no.: 793-502/000-007
WMB marking card; as card; MARKED; 1 ... 10 (10x); not stretchable; Horizontal marking; snap-on type

www.wago.com/793-502/000-007



Item no.: 793-502/000-012
WMB marking card; as card; MARKED; 1 ... 10 (10x); not stretchable; Horizontal marking; snap-on type

www.wago.com/793-502/000-012



Item no.: 793-502/000-017
WMB marking card; as card; MARKED; 1 ... 10 (10x); not stretchable; Horizontal marking; snap-on type

www.wago.com/793-502/000-017



Item no.: 793-502/000-023
WMB marking card; as card; MARKED; 1 ... 10 (10x); not stretchable; Horizontal marking; snap-on type

www.wago.com/793-502/000-023



Item no.: 793-502/000-024
WMB marking card; as card; MARKED; 1 ... 10 (10x); not stretchable; Horizontal marking; snap-on type

www.wago.com/793-502/000-024



Item no.: 793-503
WMB marking card; as card; MARKED; 11 ... 20 (10x); not stretchable; Horizontal marking; snap-on type

www.wago.com/793-503



Item no.: 793-503/000-002
WMB marking card; as card; MARKED; 11 ... 20 (10x); not stretchable; Horizontal marking; snap-on type

www.wago.com/793-503/000-002



Item no.: 793-503/000-005
WMB marking card; as card; MARKED; 11 ... 20 (10x); not stretchable; Horizontal marking; snap-on type

www.wago.com/793-503/000-005



Item no.: 793-503/000-006 www.wago.com/793-503/000-006
 WMB marking card; as card; MARKED; 11 ... 20 (10x); not stretchable; Horizontal marking; snap-on type



Item no.: 793-503/000-007 www.wago.com/793-503/000-007
 WMB marking card; as card; MARKED; 11 ... 20 (10x); not stretchable; Horizontal marking; snap-on type



Item no.: 793-503/000-012 www.wago.com/793-503/000-012
 WMB marking card; as card; MARKED; 11 ... 20 (10x); not stretchable; Horizontal marking; snap-on type



Item no.: 793-503/000-017 www.wago.com/793-503/000-017
 WMB marking card; as card; MARKED; 11 ... 20 (10x); not stretchable; Horizontal marking; snap-on type



Item no.: 793-503/000-023 www.wago.com/793-503/000-023
 WMB marking card; as card; MARKED; 11 ... 20 (10x); not stretchable; Horizontal marking; snap-on type



Item no.: 793-503/000-024 www.wago.com/793-503/000-024
 WMB marking card; as card; MARKED; 11 ... 20 (10x); not stretchable; Horizontal marking; snap-on type



Item no.: 793-504 www.wago.com/793-504
 WMB marking card; as card; MARKED; 21 ... 30 (10x); not stretchable; Horizontal marking; snap-on type



Item no.: 793-504/000-002 www.wago.com/793-504/000-002
 WMB marking card; as card; MARKED; 21 ... 30 (10x); not stretchable; Horizontal marking; snap-on type



Item no.: 793-504/000-005 www.wago.com/793-504/000-005
 WMB marking card; as card; MARKED; 21 ... 30 (10x); not stretchable; Horizontal marking; snap-on type



Item no.: 793-504/000-006 www.wago.com/793-504/000-006
 WMB marking card; as card; MARKED; 21 ... 30 (10x); not stretchable; Horizontal marking; snap-on type



Item no.: 793-504/000-012 www.wago.com/793-504/000-012
 WMB marking card; as card; MARKED; 21 ... 30 (10x); not stretchable; Horizontal marking; snap-on type



Item no.: 793-504/000-017 www.wago.com/793-504/000-017
 WMB marking card; as card; MARKED; 21 ... 30 (10x); not stretchable; Horizontal marking; snap-on type



Item no.: 793-504/000-023 www.wago.com/793-504/000-023
 WMB marking card; as card; MARKED; 21 ... 30 (10x); not stretchable; Horizontal marking; snap-on type



Item no.: 793-505 www.wago.com/793-505
 WMB marking card; as card; MARKED; 31 ... 40 (10x); not stretchable; Horizontal marking; snap-on type



Item no.: 793-505/000-005 www.wago.com/793-505/000-005
 WMB marking card; as card; MARKED; 31 ... 40 (10x); not stretchable; Horizontal marking; snap-on type



Item no.: 793-505/000-006

WMB marking card; as card; MARKED; 31 ... 40 (10x); not stretchable; Horizontal marking; snap-on type www.wago.com/793-505/000-006



Item no.: 793-505/000-007

WMB marking card; as card; MARKED; 31 ... 40 (10x); not stretchable; Horizontal marking; snap-on type www.wago.com/793-505/000-007



Item no.: 793-505/000-012

WMB marking card; as card; MARKED; 31 ... 40 (10x); not stretchable; Horizontal marking; snap-on type www.wago.com/793-505/000-012



Item no.: 793-506

WMB marking card; as card; MARKED; 41 ... 50 (10x); not stretchable; Horizontal marking; snap-on type www.wago.com/793-506



Item no.: 793-506/000-005

WMB marking card; as card; MARKED; 41 ... 50 (10x); not stretchable; Horizontal marking; snap-on type www.wago.com/793-506/000-005



Item no.: 793-506/000-006

WMB marking card; as card; MARKED; 41 ... 50 (10x); not stretchable; Horizontal marking; snap-on type www.wago.com/793-506/000-006



Item no.: 793-506/000-012

WMB marking card; as card; MARKED; 41 ... 50 (10x); not stretchable; Horizontal marking; snap-on type www.wago.com/793-506/000-012



Item no.: 793-506/000-017

WMB marking card; as card; MARKED; 41 ... 50 (10x); not stretchable; Horizontal marking; snap-on type www.wago.com/793-506/000-017



Item no.: 793-5501

WMB marking card; as card; for terminal block width 5 - 17.5 mm; stretchable 5 - 5.2 mm; plain; snap-on type www.wago.com/793-5501



Item no.: 793-5501/000-002

WMB marking card; as card; for terminal block width 5 - 17.5 mm; stretchable 5 - 5.2 mm; plain; snap-on type www.wago.com/793-5501/000-002



Item no.: 793-5501/000-005

WMB marking card; as card; stretchable 5 - 5.2 mm; plain; snap-on type www.wago.com/793-5501/000-005



Item no.: 793-5501/000-006

WMB marking card; as card; stretchable 5 - 5.2 mm; plain; snap-on type www.wago.com/793-5501/000-006



Item no.: 793-5501/000-007

WMB marking card; as card; stretchable 5 - 5.2 mm; plain; snap-on type www.wago.com/793-5501/000-007



Item no.: 793-5501/000-012

WMB marking card; as card; stretchable 5 - 5.2 mm; plain; snap-on type www.wago.com/793-5501/000-012



Item no.: 793-5501/000-014

WMB marking card; as card; stretchable 5 - 5.2 mm; plain; snap-on type www.wago.com/793-5501/000-014



Item no.: 793-5501/000-017
WMB marking card; as card; stretchable 5 - 5.2 mm; plain; snap-on type

www.wago.com/793-5501/000-017



Item no.: 793-5501/000-023
WMB marking card; as card; stretchable 5 - 5.2 mm; plain; snap-on type

www.wago.com/793-5501/000-023



Item no.: 793-5501/000-024
WMB marking card; as card; stretchable 5 - 5.2 mm; plain; snap-on type

www.wago.com/793-5501/000-024



Item no.: 793-566
WMB marking card; as card; MARKED; 1 ... 50 (2x); not stretchable; Horizontal marking; snap-on type

www.wago.com/793-566



Item no.: 793-566/000-002
WMB marking card; as card; MARKED; 1 ... 50 (2x); not stretchable; Horizontal marking; snap-on type

www.wago.com/793-566/000-002



Item no.: 793-566/000-005
WMB marking card; as card; MARKED; 1 ... 50 (2x); not stretchable; Horizontal marking; snap-on type

www.wago.com/793-566/000-005



Item no.: 793-566/000-006
WMB marking card; as card; MARKED; 1 ... 50 (2x); not stretchable; Horizontal marking; snap-on type

www.wago.com/793-566/000-006



Item no.: 793-566/000-007
WMB marking card; as card; MARKED; 1 ... 50 (2x); not stretchable; Horizontal marking; snap-on type

www.wago.com/793-566/000-007



Item no.: 793-566/000-012
WMB marking card; as card; MARKED; 1 ... 50 (2x); not stretchable; Horizontal marking; snap-on type

www.wago.com/793-566/000-012



Item no.: 793-566/000-017
WMB marking card; as card; MARKED; 1 ... 50 (2x); not stretchable; Horizontal marking; snap-on type

www.wago.com/793-566/000-017



Item no.: 793-566/000-023
WMB marking card; as card; MARKED; 1 ... 50 (2x); not stretchable; Horizontal marking; snap-on type

www.wago.com/793-566/000-023



Item no.: 793-566/000-024
WMB marking card; as card; MARKED; 1 ... 50 (2x); not stretchable; Horizontal marking; snap-on type

www.wago.com/793-566/000-024

Downloads

Documentation

Bid Text

788-700	Jan 22, 2016	DOC	Download
Solid-State-Relais		27.1 kB	



Instruction Leaflet

Socket with Relay or SSR	Sep 28, 2015	PDF 2.1 MB	Download
--------------------------	--------------	---------------	----------

Additional Information

Disposal; Electrical and electronic equipment, Packaging	Oct 15, 2018	265.8 kB	Download
--	--------------	----------	----------

smartDATA

CAD data

3D Download 788-700		URL	Download
---------------------	--	-----	----------

Subject to changes.