

HIGH ELECTRICAL & MECHANICAL NOISE IMMUNITY RELAY

JQ RELAYS

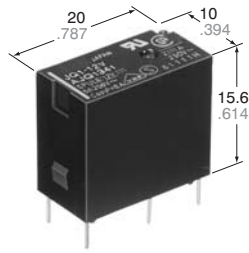

mm inch

FEATURES

- High electrical noise immunity
- High switching capacity in a compact package
- High sensitivity: 200 mW (1a), 400 mW (1c)
- High surge voltage: 8,000 V between contacts and coil
- UL, CSA, VDE, TÜV, SEMKO approved
- Class B coil insulation type available

About Cd-free contacts

We have introduced cadmium-free type products to reduce environmentally hazardous substances. Please replace parts that contain cadmium with Cd-free products. Evaluate them with your actual application before use because the life of a relay depends on the contact material and load.

SPECIFICATIONS

Contact

		Standard type	High capacity type	
Arrangement		1 Form A, 1 Form C		
Initial contact resistance, max. (By voltage drop 6 V DC 1 A)		100 mΩ		
Contact material		AgSnO ₂ type		
Rating (resistive)	Nominal switching capacity	1a	5 A 125 V AC, 2 A 250 V AC, 5 A 30 V DC	10 A 125 V AC, 5 A 250 V AC, 5 A 30 V DC
		1c	N.O.	5 A 125 V AC, 2 A 250 V AC, 3 A 30 V AC
	N.C.		2 A 125 V AC, 1 A 250 V AC, 1 A 30 V DC	3 A 125 V AC, 2 A 250 V AC, 1 A 30 V DC
	Max. switching power	1a	625 VA, 150 W	
		1c	N.O.	625 VA, 90 W
	N.C.		250 VA, 30 W	500 V AC, 30 W
Max. switching voltage		250 V AC, 110 V DC (0.3A)		
Max. switching current		N.O.: 5 A N.C.: 2 A		
Min. switching capacity ^{#1}		100 mA, 5 V DC		
Expected mechanical life (at 180 cpm)(min. operations)		10 ⁷		

Expected electrical life (min. operations)

Type	Switching capacity		No. of operations
Standard type	1a	5 A 125 V AC	5×10 ⁴
		3 A 125 V AC	2×10 ⁵
	1c	2 A 250 V AC	2×10 ⁵
		5 A 30 V DC	10 ⁵
High capacity type	1a	10 A 125 V AC	5×10 ⁴
		5 A 250 V AC	5×10 ⁴
	1c	5 A 30 V DC	10 ⁵
		N.O.	10 A 125 V AC
1c	N.O.	5 A 250 V AC	5×10 ⁴
	N.C.	5 A 30 V DC	10 ⁵
1c	N.O.	3 A 125 V AC	2×10 ⁵
	N.C.	2 A 250 V AC	2×10 ⁵
		1 A 30 V DC	10 ⁵

Coil (at 20°C 68°F)

Nominal operating power	1a: 200 mW	1c: 400 mW
-------------------------	------------	------------

#1 This value can change due to the switching frequency, environmental conditions, and desired reliability level, therefore it is recommended to check this with the actual load.

Characteristics

Max. operating speed		20 cpm
Initial insulation resistance*1		Min. 1,000 MΩ at 500 V DC
Initial breakdown voltage*2	Between open contacts	1a: 1,000 Vrms for 1 min. 1c: 750 Vrms for 1 min.
	Between contacts and coil	4,000 Vrms for 1 min.
Surge voltage between contact and coil*3		8,000 V
Operate time*4 (at nominal voltage)		Max. 20 ms
Release time*4 (at nominal voltage)(without diode)		Max. 10 ms
Temperature rise*5		Max. 45°C
Shock resistance	Functional*6	Min. 294 m/s ² {30 G}
	Destructive*7	Min. 980 m/s ² {100 G}
Vibration resistance	Functional*8	98 m/s ² {10 G}, 10 to 55 Hz at double amplitude of 1.6 mm
	Destructive	117.6 m/s ² {12 G}, 10 to 55 Hz at double amplitude of 2.0 mm
Conditions for operation, transport and storage*9 (Not freezing and condensing at low temperature)		Ambient temp.*10
		Humidity
Unit weight		Approx. 7 g .25 oz

Remarks

* Specifications will vary with foreign standards certification ratings.

*1 Measurement at same location as "Initial breakdown voltage" section

*2 Detection current: 10 mA

*3 Wave is standard shock voltage of $\pm 1.2 \times 50\mu\text{s}$ according to JEC-212-1981

*4 Excluding contact bounce time

*5 Measured conditions

Standard type	Resistive, nominal voltage applied to the coil. Contact carrying current: 5 A, at 70°C 158°F
High capacity type	Resistive, nominal voltage applied to the coil. Contact carrying current: 10 A, at 70°C 158°F

*6 Half-wave pulse of sine wave: 11ms; detection time: 10μs

*7 Half-wave pulse of sine wave: 6ms

*8 Detection time: 10μs

*9 Refer to 6. Conditions for operation, transport and storage mentioned in [AMBIENT ENVIRONMENT \(p. 19, Relay Technical Information\)](#).

*10 When using relays in a high ambient temperature, consider the pick-up voltage rise due to the high temperature (a rise of approx. 0.4% V for each 1°C 33.8°F with 20°C 68°F as a reference) and use a coil impressed voltage that is within the maximum allowable voltage range.

TYPICAL APPLICATIONS

- Air conditioners
- Refrigerators
- Microwave ovens
- Heaters

ORDERING INFORMATION

Ex. JQ 1a P — B — 12 V — F

Contact arrangement	Contact capacity	Coil insulation class	Coil voltage (DC)	Contact material
1a: 1 Form A 1: 1 Form C	Nil: Standard P: High capacity	Nil: Class E coil insulation B: Class B coil insulation	5, 6, 9, 12, 18, 24, 48* V	F: AgSnO ₂ type

UL/CSA, VDE, SEMKO approved type is standard.

* Available only for 1 Form C type

TYPES AND COIL DATA at 20°C 68°F

	Part No.	Nominal voltage, V DC	Pick-up voltage, V DC (min.)	Drop-out voltage, V DC (min.)	Nominal operating current, mA	Nominal operating power, mW	Coil resistance, Ω (±10%)	Max. allowable voltage, V DC	
1 Form A	Standard type		JQ1a-5V-F	5	3.75	0.25	40	200	125
	JQ1a-6V-F	6	4.5	0.3	33.3	180			
	JQ1a-9V-F	9	6.75	0.45	22.2	405			
	JQ1a-12V-F	12	9	0.6	16.7	720			
	JQ1a-18V-F	18	13.5	0.9	11.1	1,620			
	JQ1a-24V-F	24	18	1.2	8.3	2,880			
High capacity type	JQ1aP-5V-F	5	4	0.25	40	125	200	130% of nominal voltage (at 85°C 185°F)	
	JQ1aP-6V-F	6	4.8	0.3	33.3	180			
	JQ1aP-9V-F	9	7.2	0.45	22.2	405			
	JQ1aP-12V-F	12	9.6	0.6	16.7	720			
	JQ1aP-18V-F	18	14.4	0.9	11.1	1,620			
	JQ1aP-24V-F	24	19.2	1.2	8.3	2,880			
1 Form C	Standard type		JQ1-5V-F	5	3.75	0.25	80	400	150% of nominal voltage (at 20°C 68°F)
	JQ1-6V-F	6	4.5	0.3	66.7	90			
	JQ1-9V-F	9	6.75	0.45	44.4	202.5			
	JQ1-12V-F	12	9	0.6	33.3	360			
	JQ1-18V-F	18	13.5	0.9	22.2	810			
	JQ1-24V-F	24	18	1.2	16.7	1,440			
	JQ1-48V-F	48	36	2.4	8.3	5,760			
	High capacity type		JQ1P-5V-F	5	4	0.25	80		
JQ1P-6V-F	6	4.8	0.3	66.7	90				
JQ1P-9V-F	9	7.2	0.45	44.4	202.5				
JQ1P-12V-F	12	9.6	0.6	33.3	360				
JQ1P-18V-F	18	14.4	0.9	22.2	810				
JQ1P-24V-F	24	19.2	1.2	16.7	1,440				
JQ1P-48V-F	48	38.4	2.4	8.3	5,760				

DIMENSIONS

mm inch



1 Form A

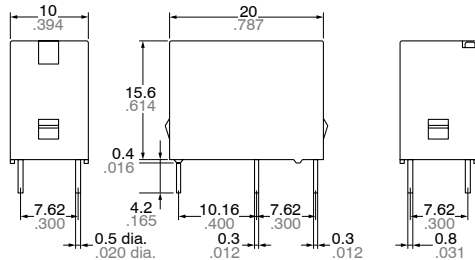

Schematic (Bottom view)

1 Form A

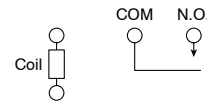

1 Form C

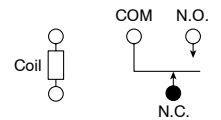

1 Form C

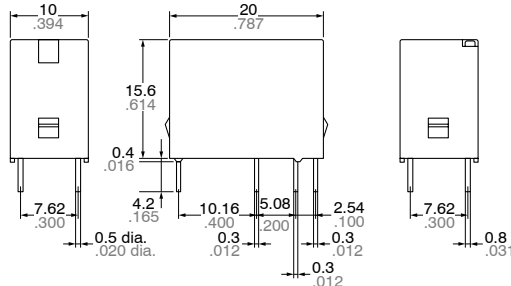

PC board pattern (Bottom view)

1 Form A

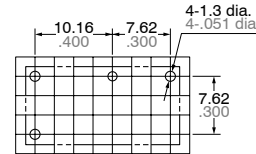

1FormC

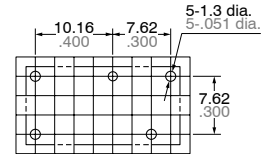

Tolerance: ±0.1 ±.004

Dimension :	General tolerance
Max. 1mm .039 inch	±0.2 ±.008
1 to 5mm .039 to .118 inch	±0.3 ±.012
Min. 5mm .118 inch	±0.4 ±.016

REFERENCE DATA

Max. switching capacity (1 Form A type)

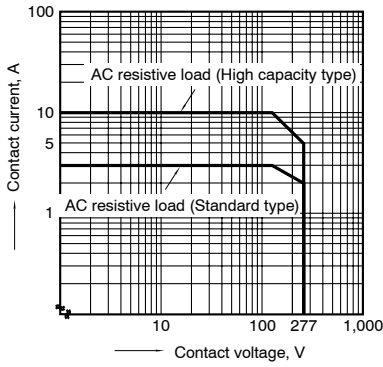

Max. switching capacity (1 Form C type)

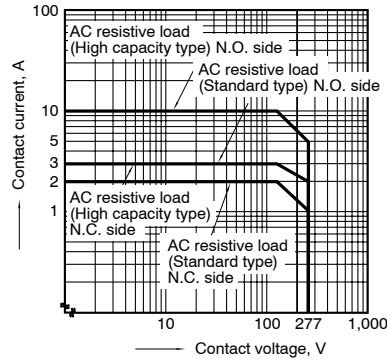

Standard type

1-(1). Operate & release time (1 Form A type)
Tested sample: JQ1a-12V-F, 25 pcs.

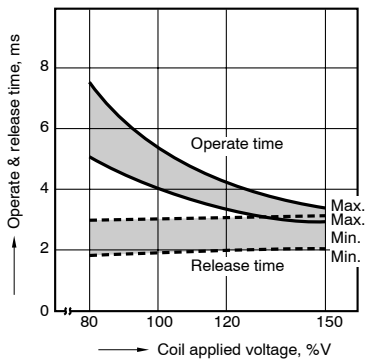

1-(2). Operate & release time (1 Form C type)
Tested sample: JQ1-24V-F, 25 pcs.

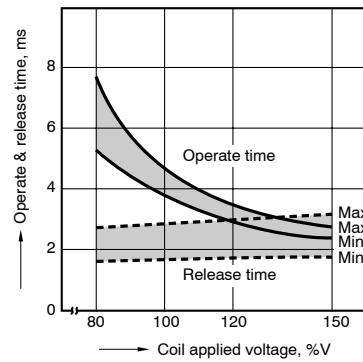

2. Life curve

Ambient temperature: room temperature

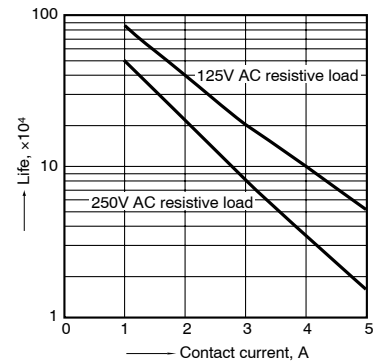

3-(1). Coil temperature rise (1 Form A type)
Contact carrying current: 3 A, 5 A
Measured portion: Inside the coil

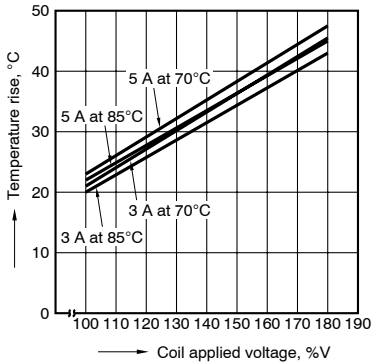

3-(2). Coil temperature rise (1 Form C type)
Contact carrying current: 3 A, 5 A
Measured portion: Inside the coil

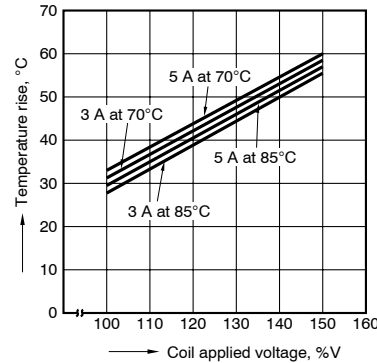

4-(1). Ambient temperature characteristics (1 Form A type)

Tested sample: JQ1a-24V-F
Contact carrying current: 3 A, 5 A

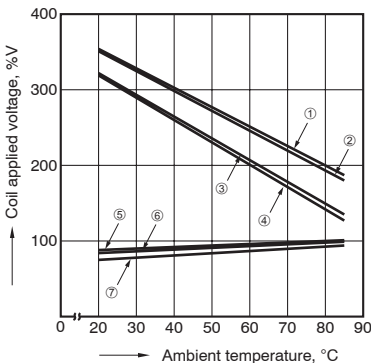

4-(2). Ambient temperature characteristics (1 Form C type)

Tested sample: JQ1-24V-F
Contact carrying current: 3 A, 5 A

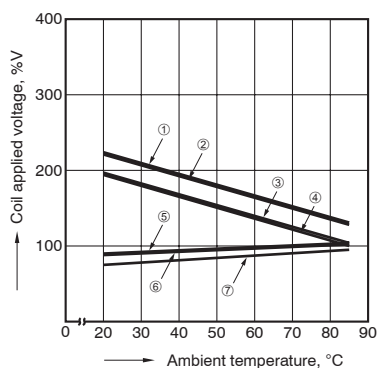

- ① Allowable ambient temperature against % coil voltage (max. inside the coil temperature set as 130°C 266°F) (Carrying current: 3 A)
- ② Allowable ambient temperature against % coil voltage (max. inside the coil temperature set as 130°C 266°F) (Carrying current: 5 A)
- ③ Allowable ambient temperature against % coil voltage (max. inside the coil temperature set as 115°C 239°F) (Carrying current: 3 A)
- ④ Allowable ambient temperature against % coil voltage (max. inside the coil temperature set as 115°C 239°F) (Carrying current: 5 A)
- ⑤ Pick-up voltage with a hot-start condition of 100%V on the coil (Carrying current: 5 A)
- ⑥ Pick-up voltage with a hot-start condition of 100%V on the coil (Carrying current: 3 A)
- ⑦ Pick-up voltage

High capacity type

1-(1). Operate & release time (1 Form A type)
 Tested sample: JQ1aP-12V-F, 25 pcs.

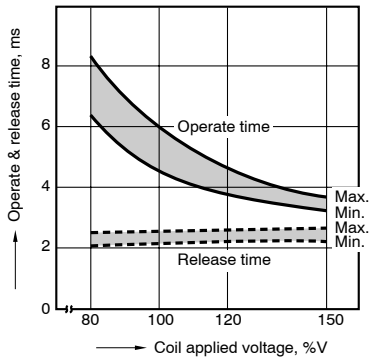

1-(2). Operate & release time (1 Form C type)
 Tested sample: JQ1P-12V-F, 25 pcs.

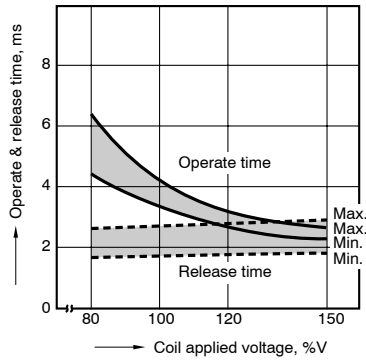

2. Life curve

Ambient temperature: room temperature

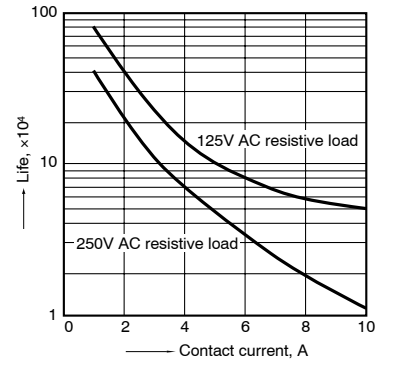

3-(1). Coil temperature rise (1 Form A type)
 Contact carrying current: 5 A, 10 A
 Measured portion: Inside the coil

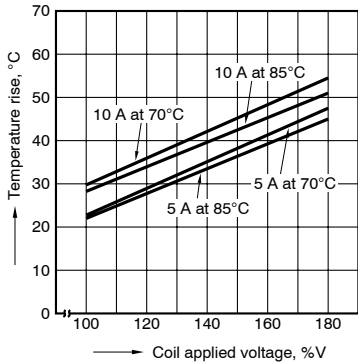

3-(2). Coil temperature rise (1 Form C type)
 Contact carrying current: 5 A, 10 A
 Measured portion: Inside the coil

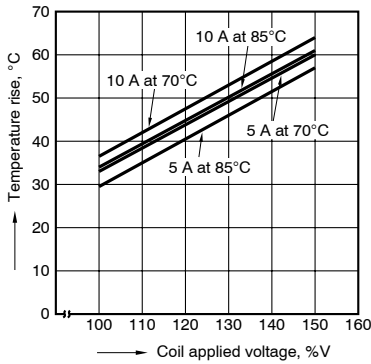

4-(1). Ambient temperature characteristics (1 Form A type)
 Tested sample: JQ1aP-24V-F
 Contact carrying current: 5 A, 10 A

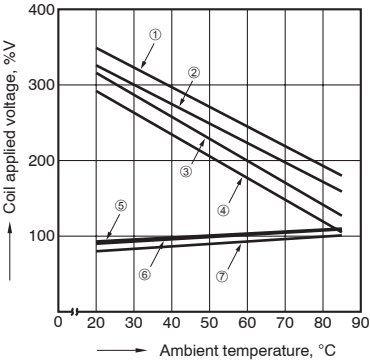

4-(2). Ambient temperature characteristics (1 Form C type)
 Tested sample: JQ1P-24V-F
 Contact carrying current: 5 A, 10 A

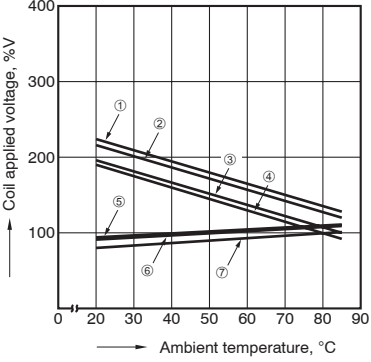

- ① Allowable ambient temperature against % coil voltage (max. inside the coil temperature set as 130°C 266°F) (Carrying current: 5 A)
- ② Allowable ambient temperature against % coil voltage (max. inside the coil temperature set as 130°C 266°F) (Carrying current: 10 A)
- ③ Allowable ambient temperature against % coil voltage (max. inside the coil temperature set as 115°C 239°F) (Carrying current: 5 A)
- ④ Allowable ambient temperature against % coil voltage (max. inside the coil temperature set as 115°C 239°F) (Carrying current: 10 A)
- ⑤ Pick-up voltage with a hot-start condition of 100%V on the coil (Carrying current: 10 A)
- ⑥ Pick-up voltage with a hot-start condition of 100%V on the coil (Carrying current: 5 A)
- ⑦ Pick-up voltage

For Cautions for Use, see [Relay Technical Information](#).