

FEATURES

- High sensitivity**
 - 50mW nominal operating power (single side stable 1.5-12V)
 - Useful for electric-power-saving
- Approx. 0.3μV low thermal electromotive force**

- Outstanding surge resistance**
 - Surge withstand between open contacts: 1,500V 10×160μs (FCC part 68)
 - Surge withstand between contacts and coil: 2,500V 2×10μs (Telcordia)

SPECIFICATIONS

Contact

Arrangement	2 Form C	
Initial contact resistance, max. (By voltage drop 6 V DC 1 A)	100 mΩ	
Contact material	Standard contact: Ag+Au clad, AgPd contact (low level load): AgPd+Au clad (stationary), AgPd (movable)	
Rating	Nominal switching capacity (resistive load)	1 A 30 V DC
	Max. switching power (resistive load)	30 W (DC)
	Max. switching voltage	110 V DC
	Max. switching current	1 A
	Min. switching capacity (Reference value) ^{#1}	10 μA 10 mV DC
Nominal operating power	Single side stable	50 mW (1.5 to 12 V DC) 70 mW (24 V DC)
	1 coil latching	35 mW (1.5 to 12 V DC) 50 mW (24 V DC)
	2 coil latching	70 mW (1.5 to 12 V DC) 150 mW (24 V DC)
Expected life (min. operations)	Mechanical (at 180 cpm)	5×10 ⁷
	Electrical (at 20 cpm) 1 A 30 V DC resistive	2×10 ⁵

Note:

#1 This value can change due to the switching frequency, environmental conditions, and desired reliability level, therefore it is recommended to check this with the actual load. (AgPd contact type or SX relays are available for low level load switching [10V DC, 10mA max. level])

Remarks

- * Specifications will vary with foreign standards certification ratings.
- *1 Measurement at same location as "Initial breakdown voltage" section.
- *2 Detection current: 10mA
- *3 Excluding contact bounce time.
- *4 By resistive method; nominal voltage applied to the coil; contact carrying current: 1 A.

Characteristics

Initial insulation resistance ^{*1}	Min. 1,000 MW (at 500 V DC)	
Initial breakdown voltage ^{*2}	Between open contacts	750 Vrms for 1min.
	Between contact sets	1,000 Vrms for 1min.
Initial surge voltage	Between contacts and coil	1,800 Vrms for 1min.
	Between open contacts (10 × 160μs)	1,500V (FCC Part 68)
Operate time [Set time] ^{*3} (at 20°C)(at nominal voltage)	Between contacts and coil (2 × 10 μs)	2,500V (Telcordia)
		Max. 5 ms [Max. 5 ms]
Release time (without diode) [Reset time] ^{*3} (at 20°C)(at nominal voltage)	Max. 5 ms [Max. 5 ms]	
Temperature rise ^{*4} (at 20°C)	Max. 50°C	
Shock resistance	Functional ^{*5}	Min. 750 m/s ² {75 G}
	Destructive ^{*6}	Min. 1,000 m/s ² {100 G}
Vibration resistance	Functional ^{*7}	10 to 55 Hz at double amplitude of 3.3 mm
	Destructive	10 to 55 Hz at double amplitude of 5 mm
Conditions for operation, transport and storage ^{*8} (Not freezing and condensing at low temperature)	Ambient temperature	-40°C to +70°C -40°F to +158°F
	Humidity	5 to 85% R.H.
Unit weight	Approx. 2 g .071 oz	

*5 Half-wave pulse of sine wave: 6 ms; detection time: 10 μs

*6 Half-wave pulse of sine wave: 6 ms

*7 Detection time: 10 μs

*8 Refer to 6. Conditions for operation, transport and storage mentioned in [AMBIENT ENVIRONMENT \(p. 19, Relay Technical Information\)](#).

TYPICAL APPLICATIONS

- Communications (XDSL, Transmission)
- Measurement
- Security
- Home appliances, and audio/visual equipment
- Automotive equipment
- Medical equipment

ORDERING INFORMATION

Ex. TXS 2 SA — L — H — 3V — Z

Contact arrangement	Surface-mount availability	Operating function	Terminal shape	Coil voltage (DC)	Packing style
2: 2 Form C	Nil: Standard PC board terminal type or self-clinching terminal type SA: Standard surface-mount terminal type SL: High connection reliability surface-mount terminal type SS: Space saving surface-mount terminal type	Nil: Single side stable L: 1 coil latching L2: 2 coil latching	Nil: Standard PC board terminal or surface-mount terminal H: Self-clinching terminal	1.5, 3, 4.5, 6, 9, 12, 24 V	Nil: Tube packing Z: Tape and reel packing (piked from the 8/9/10/12-pin side)

Notes: 1. Tape and reel (picked from 1/3/4/5-pin side) is also available by request. Part number suffix "-X" is needed when ordering.

(ex.) TXS2SA-3 V-X

2. Tape and reel packing symbol "-Z" or "-X" are not marked on the relay.

TYPES AND COIL DATA (at 20°C 68°F)

1) Standard PC board terminal type and self-clinching terminal type

Single side stable

Part No.		Nominal voltage, V DC	Pick-up voltage, V DC (max.)	Drop-out voltage, V DC (min.)	Nominal operating current, mA (±10%)	Coil resistance, Ω (±10%)	Nominal operating power, mW	Max. Allowable voltage, V DC
Standard PC board terminal	Self-clinching terminal							
TXS2-1.5V	TXS2-H-1.5V	1.5	1.2	0.15	33.3	45	50	2.2
TXS2-3V	TXS2-H-3V	3	2.4	0.3	16.7	180	50	4.5
TXS2-4.5V	TXS2-H-4.5V	4.5	3.6	0.45	11.1	405	50	6.7
TXS2-6V	TXS2-H-6V	6	4.8	0.6	8.3	720	50	9
TXS2-9V	TXS2-H-9V	9	7.2	0.9	5.6	1,620	50	13.5
TXS2-12V	TXS2-H-12V	12	9.6	1.2	4.2	2,880	50	18
TXS2-24V	TXS2-H-24V	24	19.2	2.4	2.9	8,229	70	36

1 coil latching

Part No.		Nominal voltage, V DC	Set voltage, V DC (max.)	Reset voltage, V DC (Max.)	Nominal operating current, mA (±10%)	Coil resistance, Ω (±10%)	Nominal operating power, mW	Max. Allowable voltage, V DC
Standard PC board terminal	Self-clinching terminal							
TXS2-L-1.5V	TXS2-L-H-1.5V	1.5	1.2	1.2	23.3	64.3	35	2.2
TXS2-L-3V	TXS2-L-H-3V	3	2.4	2.4	11.7	257	35	4.5
TXS2-L-4.5V	TXS2-L-H-4.5V	4.5	3.6	3.6	7.8	579	35	6.7
TXS2-L-6V	TXS2-L-H-6V	6	4.8	4.8	5.8	1,029	35	9
TXS2-L-9V	TXS2-L-H-9V	9	7.2	7.2	3.9	2,314	35	13.5
TXS2-L-12V	TXS2-L-H-12V	12	9.6	9.6	2.9	4,114	35	18
TXS2-L-24V	TXS2-L-H-24V	24	19.2	19.2	2.1	11,520	50	36

2 coil latching

Part No.		Nominal voltage, V DC	Set voltage, V DC (max.)	Reset voltage, V DC (Max.)	Nominal operating current, mA (±10%)	Coil resistance, Ω (±10%)	Nominal operating power, mW	Max. Allowable voltage, V DC
Standard PC board terminal	Self-clinching terminal							
TXS2-L2-1.5V	TXS2-L2-H-1.5V	1.5	1.2	1.2	46.7	32.1	70	2.2
TXS2-L2-3V	TXS2-L2-H-3V	3	2.4	2.4	23.3	129	70	4.5
TXS2-L2-4.5V	TXS2-L2-H-4.5V	4.5	3.6	3.6	15.6	289	70	6.7
TXS2-L2-6V	TXS2-L2-H-6V	6	4.8	4.8	11.7	514	70	9
TXS2-L2-9V	TXS2-L2-H-9V	9	7.2	7.2	7.8	1,157	70	13.5
TXS2-L2-12V	TXS2-L2-H-12V	12	9.6	9.6	5.8	2,057	70	18
TXS2-L2-24V	TXS2-L2-H-24V	24	19.2	19.2	6.3	3,840	150	36

Notes:

- Specified value of pick-up, drop-out, set and reset voltage is with the condition of square wave coil pulse.
- Standard packing: Tube: 40 pcs.; Case: 1,000 pcs.

2) Surface-mount terminal type

Single side stable

Part No.	Nominal voltage, V DC	Pick-up voltage, V DC (max.)	Drop-out voltage, V DC (min.)	Nominal operating current, mA (±10%)	Coil resistance, Ω (±10%)	Nominal operating power, mW	Max. Allowable voltage, V DC
TXS2S○-1.5 V	1.5	1.2	0.15	33.3	45	50	2.2
TXS2S○-3 V	3	2.4	0.3	16.7	180	50	4.5
TXS2S○-4.5 V	4.5	3.6	0.45	11.1	405	50	6.7
TXS2S○-6 V	6	4.8	0.6	8.3	720	50	9
TXS2S○-9 V	9	7.2	0.9	5.6	1,620	50	13.5
TXS2S○-12 V	12	9.6	1.2	4.2	2,880	50	18
TXS2S○-24 V	24	19.2	2.4	2.9	8,229	70	36

1 coil latching

Part No.	Nominal voltage, V DC	Set voltage, V DC (max.)	Reset voltage, V DC (max.)	Nominal operating current, mA (±10%)	Coil resistance, Ω (±10%)	Nominal operating power, mW	Max. Allowable voltage, V DC
TXS2S○-L-1.5 V	1.5	1.2	1.2	23.3	64.3	35	2.2
TXS2S○-L-3 V	3	2.4	2.4	11.7	257	35	4.5
TXS2S○-L-4.5 V	4.5	3.6	3.6	7.8	579	35	6.7
TXS2S○-L-6 V	6	4.8	4.8	5.8	1,029	35	9
TXS2S○-L-9 V	9	7.2	7.2	3.9	2,314	35	13.5
TXS2S○-L-12 V	12	9.6	9.6	2.9	4,114	35	18
TXS2S○-L-24 V	24	19.2	19.2	2.1	11,520	50	36

2 coil latching

Part No.	Nominal voltage, V DC	Set voltage, V DC (max.)	Reset voltage, V DC (max.)	Nominal operating current, mA (±10%)	Coil resistance, Ω (±10%)	Nominal operating power, mW	Max. Allowable voltage, V DC
TXS2S○-L2-1.5 V	1.5	1.2	1.2	46.7	32.1	70	2.2
TXS2S○-L2-3 V	3	2.4	2.4	23.3	129	70	4.5
TXS2S○-L2-4.5 V	4.5	3.6	3.6	15.6	289	70	6.7
TXS2S○-L2-6 V	6	4.8	4.8	11.7	514	70	9
TXS2S○-L2-9 V	9	7.2	7.2	7.8	1,157	70	13.5
TXS2S○-L2-12 V	12	9.6	9.6	5.8	2,057	70	18
TXS2S○-L2-24 V	24	19.2	19.2	6.3	3,840	150	36

○: For each surface-mounted terminal variation, input the following letter.
SA type: A, SL type: L, SS type: S

Notes:

1. Specified value of pick-up, drop-out, set and reset voltage is with the condition of square wave coil pulse.
2. Standard packing: Tube: 40 pcs. ; Case: 1,000 pcs.
3. Tape and reel packing is also available for surface-mount type by request. Part number suffix "-X" or "-Z" is needed when ordering.
In this case, "X" or "Z" are not marked on the relay.
Quantity in tape and reel: 500 pcs.
(ex.) • TXS2SA-3V-X • TXS2SA-L-3V-Z

└ Picked from the 1/3/4/5-pin side

└ Picked from the 8/9/10/12-pin side

DIMENSIONS

mm inch

1. Single side stable and 1 coil latching type

Standard PC board terminal

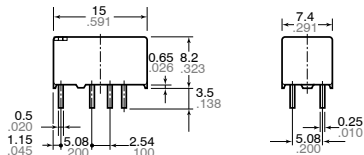

PC board pattern
(Copper-side view)

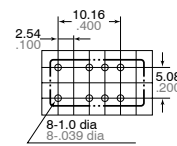

Schematic (Bottom view)
Single side stable (Deenergized condition) 1 coil latching (Reset condition)

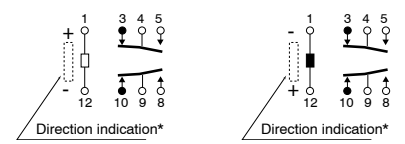

Tolerance: ±0.1 ±.004

*Orientation stripe located on top of relay.

Self clinching terminal

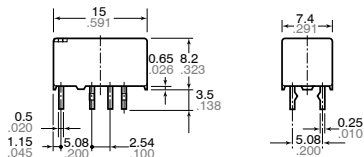

General tolerance: ±0.3 ±.012

TX-S

Surface-mount terminal
SA type

mm inch

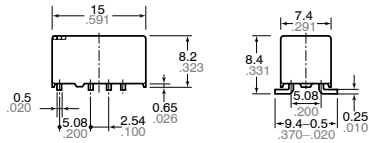

Suggested mounting pad
(Top view)

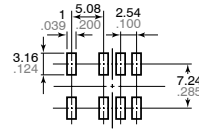

Schematic (Top view)
Single side stable
(Deenergized condition) 1 coil latching
(Reset condition)

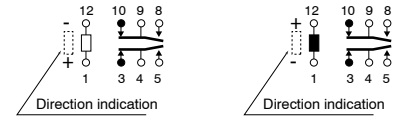

SL type

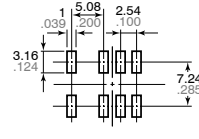
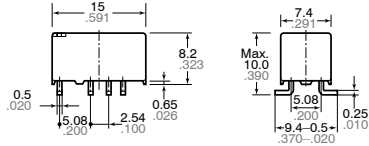

SS type

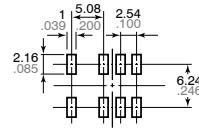
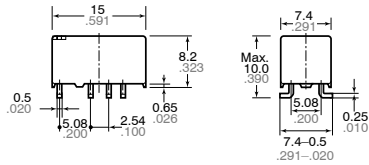

General tolerance: $\pm 0.3 \pm 0.12$

Tolerance: $\pm 0.1 \pm 0.04$

2. Coil latching type

Standard PC board terminal

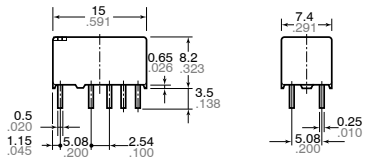

PC board pattern
(Copper side view)

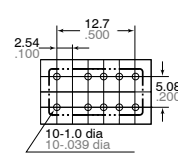

Schematic (Bottom view)
2 coil latching
(Reset condition)

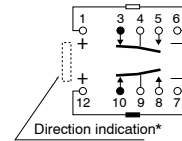

Tolerance: $\pm 0.1 \pm 0.04$

Self clinching terminal

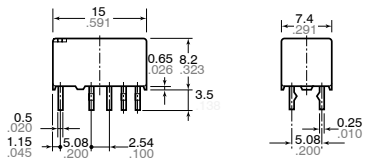

General tolerance: $\pm 0.3 \pm 0.12$

Surface-mount terminal
SA type

Suggested mounting pad
(Top view)

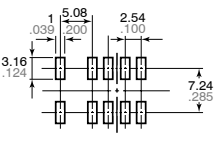

Schematic (Top view)
2 coil latching
(Reset condition)

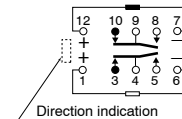

SL type

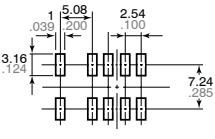
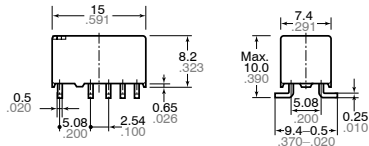

SS type

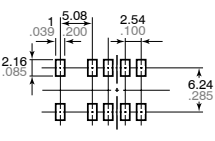
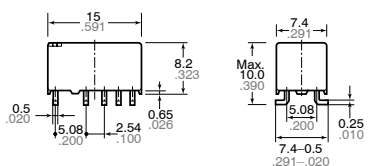

General tolerance: $\pm 0.3 \pm 0.12$

Tolerance: $\pm 0.1 \pm 0.04$

REFERENCE DATA

1. Maximum switching capacity

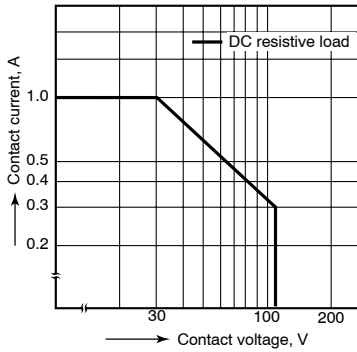

2. Life curve

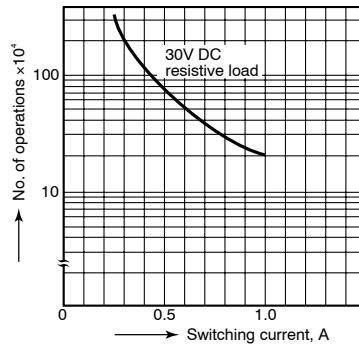

3. Mechanical life

Tested sample: TXS2-4.5V, 10 pcs.
Operating frequency: 180 cpm

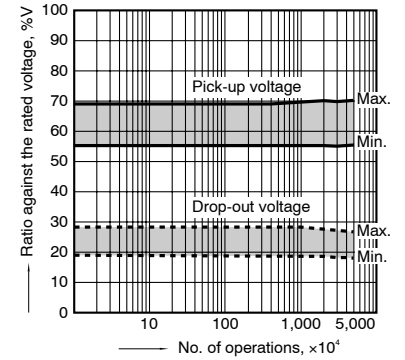

4. Electrical life (1 A 30 V DC resistive load)

Tested sample: TXS2-4.5V, 6 pcs.
Operating frequency: 20 cpm

Change of pick-up and drop-out voltage

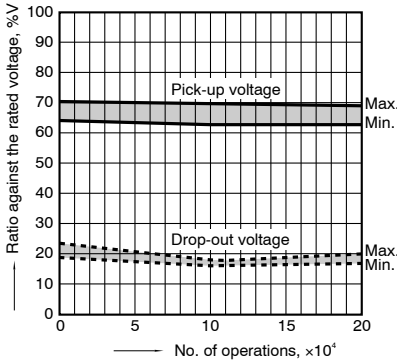

Change of contact resistance

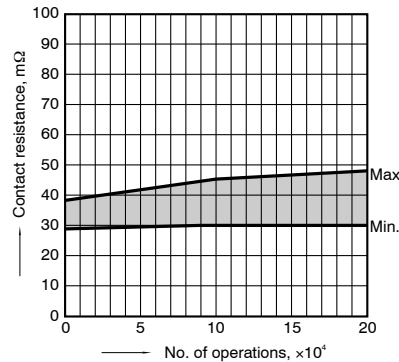

5-(1). Coil temperature rise

Tested sample: TXS2-4.5V, 6 pcs.
Point measured: Inside the coil
Ambient temperature: 25°C 77°F, 70°C 158°F

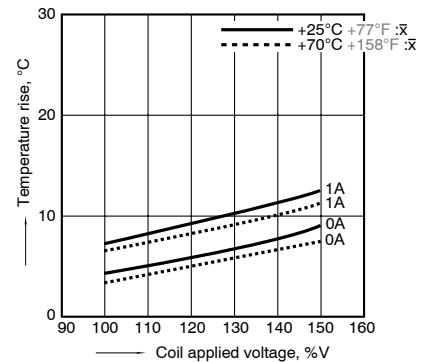

5-(2). Coil temperature rise

Tested sample: TXS2-24V, 6 pcs.
Point measured: Inside the coil
Ambient temperature: 25°C 77°F, 70°C 158°F

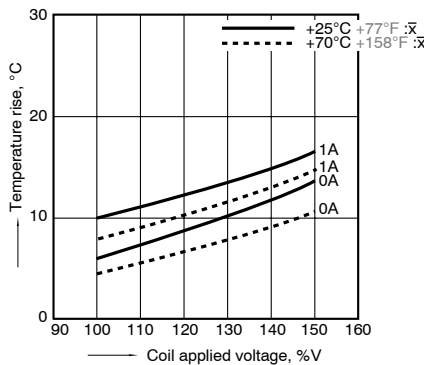

6-(1). Operate and release time (with diode)

Tested sample: TXS2-4.5V, 10 pcs.

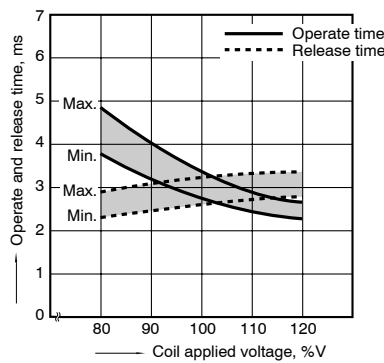

6-(2). Operate and release time (without diode)

Tested sample: TXS2-4.5V, 10 pcs.

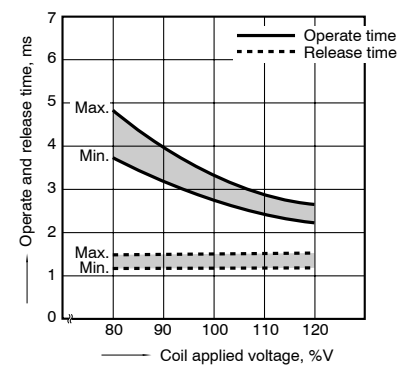

7. Distribution of pick-up and drop-out voltage

Tested sample: TXS2-4.5V, 50 pcs.

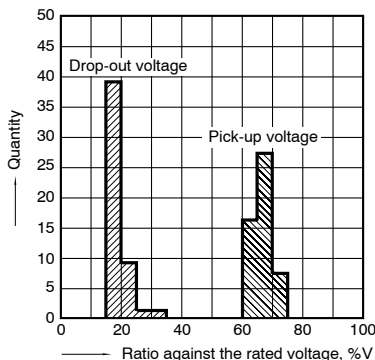

8. Distribution of set and reset voltage

Tested sample: TXS2-4.5V 30 pcs.

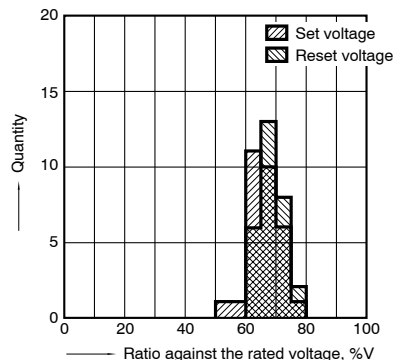

9. Ambient temperature characteristics

Tested sample: TXS2-4.5V 5 pcs.

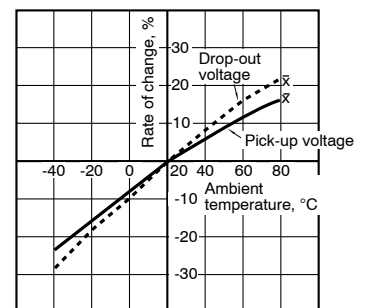

10. Distribution of contact resistance

Tested sample: TXS2-4.5V, 50 pcs. (50x4 contacts)

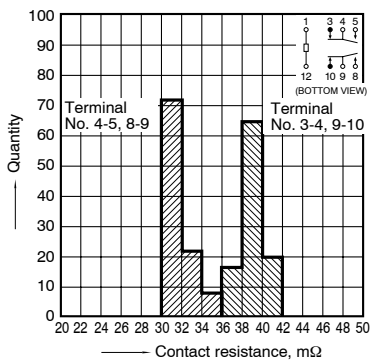

11-(1). High frequency characteristics

Tested sample: TXS2-4.5V, 2 pcs.
Isolation loss characteristics

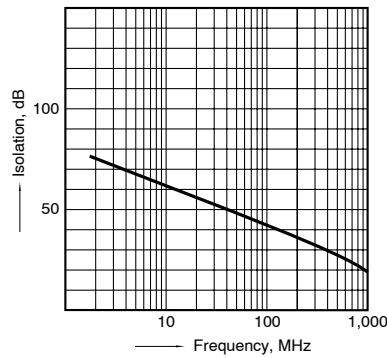

11-(2). High frequency characteristics

Tested sample: TXS2-4.5V, 2 pcs.
Insertion loss characteristics

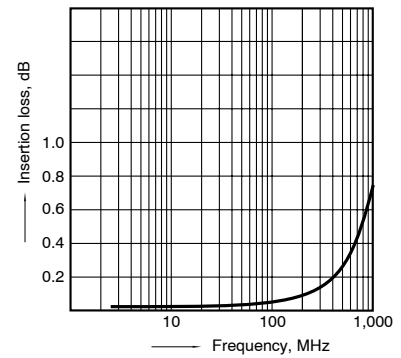

12-(1). Malfunctional shock (single side stable)

Tested sample: TXS2-4.5V, 6 pcs.

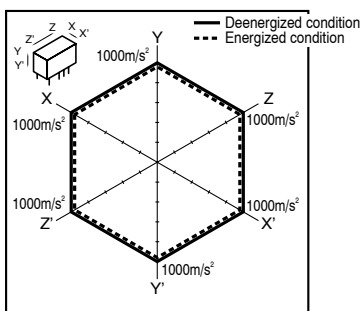

12-(2). Malfunctional shock (latching)

Tested sample: TXS2-L2-4.5V, 6 pcs.

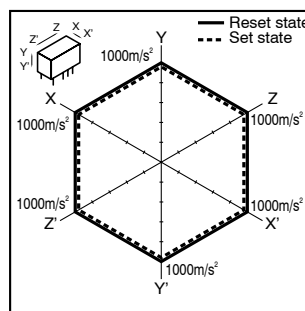

13. Thermal electromotive force

Tested sample: TXS2-4.5V, 10 pcs.

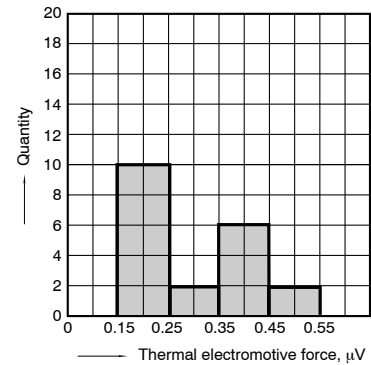

14-(1). Influence of adjacent mounting

Tested sample: TXS2-4.5V, 6 pcs.

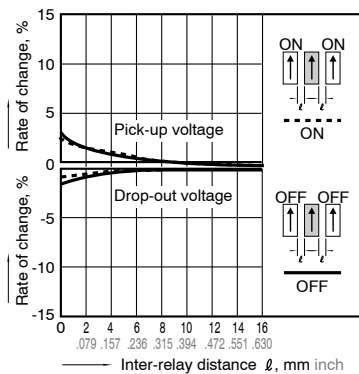

14-(2). Influence of adjacent mounting

Tested sample: TXS2-4.5V, 6 pcs.

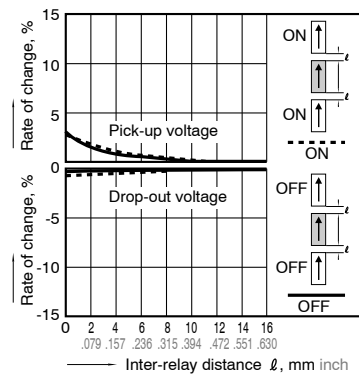

14-(3). Influence of adjacent mounting

Tested sample: TXS2-4.5V, 6 pcs.

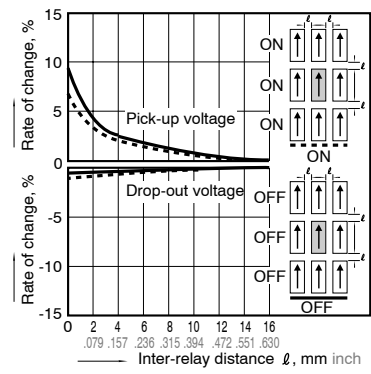

15. Pulse dialing test

Tested sample: TXS2-4.5V, 6 pcs.
(35 mA 48V DC wire spring relay load)

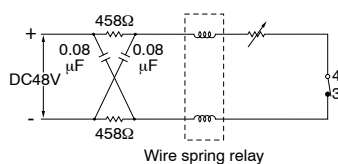

Change of pick-up and drop-out voltage

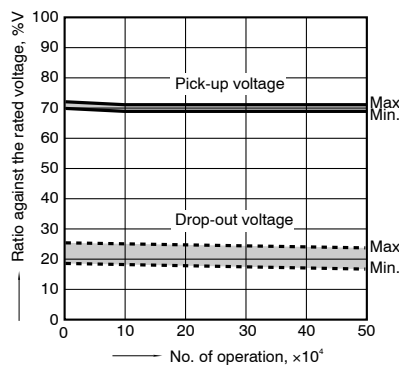

Change of contact resistance

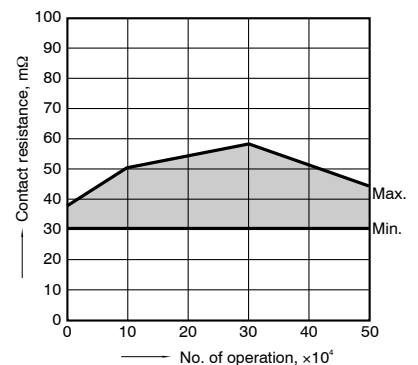

Note: Data of surface-mount type are the same as those of PC board terminal type.

NOTES

1. Packing style

1) The relay is packed in a tube with the relay orientation mark on the left side, as shown in the figure below.

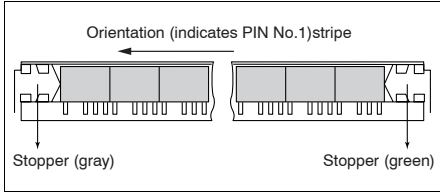

2) Tape and reel packing (surface-mount terminal type)

(1) Tape dimensions
(i) SA type

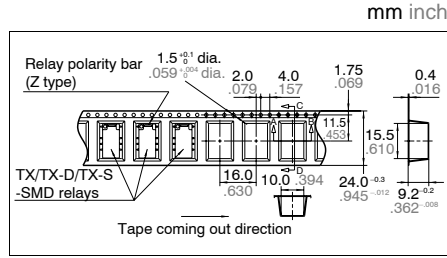

(ii) SL type

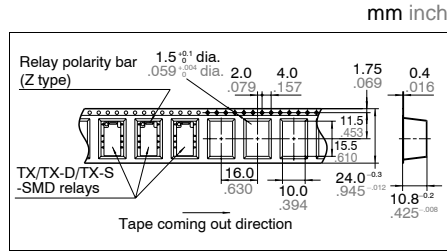

(iii) SS type

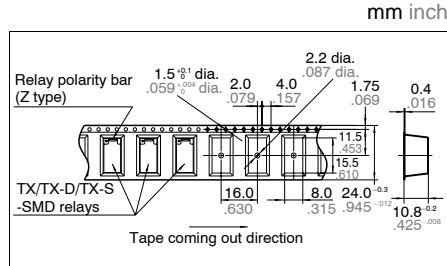

(2) Dimensions of plastic reel

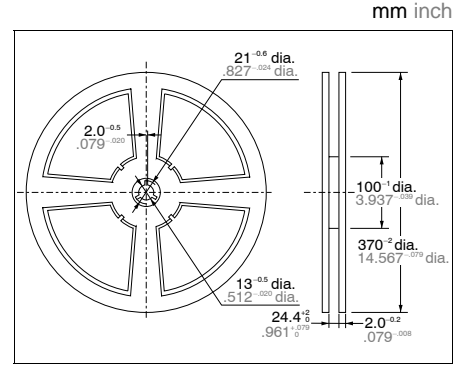

For Cautions for Use, see [Relay Technical Information](#).