

Twin type (8 terminals)

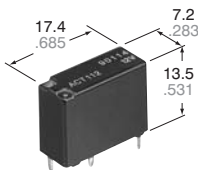

mm inch

Slim 1c type

FEATURES

- **Small & slim size**
Twin type: 17.4(L)×14.0(W)×13.5(H)mm
.685(L)×.551(W)×.531(H)inch
Slim 1c type: 17.4(L)×7.2(W)×13.5(H)mm
.685(L)×.283(W)×.531(H)inch
- **Twin (1 Form C × 2)**
Forward/reverse motor control is possible with a single relay.
- **Simple footprint enables ease of PC board layout**

※ 10 terminals layout

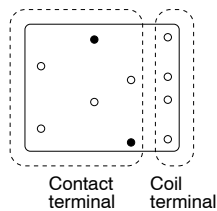

○ = 8 terminals

TYPICAL APPLICATIONS

- Power windows
- Auto door lock
- Power sunroof
- Electrically powered mirrors
- Powered seats
- Lift gates
- Slide door closers, etc.
(for DC motor forward/reverse control circuits)

SPECIFICATIONS

Contact

Arrangement	1 Form C×2, 1 Form C		
Contact material	AgSnO ₂ type		
Initial contact resistance (By voltage drop 6 V DC 1 A)	Max. 100mΩ		
Initial contact voltage drop	Max. 0.2 V (at 10 A)		
Rating	Nominal switching capacity	N.O.: 20 A 14 V DC N.C.: 10 A 14 V DC	
	Max. carrying current	35 A for 2 minutes, 25 A for 1 hour (14 V, at 20°C 68°F) 30 A for 2 minutes, 20 A for 1 hour (14 V, at 85°C 185°F)	
	Min. switching capacity ^{#1}	1 A 12 V DC	
Expected life (min. operation)	Mechanical (at 120 cpm)		
	Electrical	Resistive load	Min. 10 ^{5*1}
		Motor load	Min. 2×10 ^{5*2} (free) Min. 10 ^{5*3} (lock)

Coil

Nominal operating power	800 mW
-------------------------	--------

^{#1} This value can change due to the switching frequency, environmental conditions, and desired reliability level, therefore it is recommended to check this with the actual load.

Remarks

- ^{*1} At nominal switching capacity, operating frequency: 1s ON, 9s OFF
- ^{*2} N.O.: at 5 A (steady), 25 A (inrush)/N.C.: at 20 A (brake) 14 V DC, operating frequency: 0.5s ON, 9.5s OFF
- ^{*3} At 25A 14 V DC (Motor lock), operating frequency: 0.5s ON, 9.5s OFF
- ^{*4} Measurement at same location as "Initial breakdown voltage" section
- ^{*5} Detection current: 10mA
- ^{*6} Excluding contact bounce time
- ^{*7} Half-wave pulse of sine wave: 11ms; detection: 10μs
- ^{*8} Half-wave pulse of sine wave: 6ms

Characteristics

Max. operating speed (at nominal switching capacity)	6 cpm	
Initial insulation resistance ^{*4}	Min. 100 MΩ (at 500 V DC)	
Initial breakdown voltage ^{*5}	Between open contacts	500 Vrms for 1 min.
	Between contacts and coil	500 Vrms for 1 min.
Operate time ^{*6} (at nominal voltage) (at 20°C 68° F)	Max. 10ms (Initial)	
Release time ^{*6} (at nominal voltage) (at 20°C 68° F)	Max. 10ms (Initial)	
Shock resistance	Functional ^{*7}	Min. 100 m/s ² {10G}
	Destructive ^{*8}	Min. 1,000 m/s ² {100G}
Vibration resistance	Functional ^{*9}	10 Hz to 100 Hz, Min. 44.1m/s ² {4.5G}
	Destructive ^{*10}	10 Hz to 500 Hz, Min. 44.1m/s ² {4.5G}
Conditions for operation, transport and storage ^{*11} (Not freezing and condensing at low temperature)	Ambient temp	-40°C to +85°C -40°F to +185°F
	Humidity	5% R.H. to 85% R.H.
Mass	Approx. 8.0g .28oz (Twin type) Approx. 4.0g .14oz (Slim 1c type)	

^{*9} Detection time: 10μs

^{*10} Time of vibration for each direction;
X, Y, direction: 2 hours
Z direction: 4 hours



^{*11} Refer to 6. Conditions for operation, transport and storage mentioned in [AMBIENT ENVIRONMENT \(p. 19, Relay Technical Information\)](#).

CT (ACT)

ORDERING INFORMATION

Ex. A CT 1 12

Product name	Contact arrangement	Coil voltage (V DC)
CT	1: 1 Form C 2: 1 Form C × 2 (8 terminals type) 5: 1 Form C × 2 (10 terminals type)	12: 12

Standard packing; 1 Form C: Carton (tube package) 30pcs. Case 1,500pcs.
1 Form C × 2: Carton (tube package) 30pcs. Case 900pcs.

TYPES AND COIL DATA (at 20°C 68°F)

Contact arrangement	Part No.	Nominal voltage, V DC	Pick-up voltage, V DC (Initial)	Drop-out voltage, V DC (Initial)	Coil resistance, Ω	Nominal operating current, mA	Nominal operating power, mW	Usable voltage range, V DC
1c	ACT112	12	Max. 7.2	Min. 1.0	180±10%	66.7±10%	800	10 to 16
1c × 2 (8 terminals type)	ACT212	12	Max. 7.2	Min. 1.0	180±10%	66.7±10%	800	10 to 16
1c × 2 (10 terminals type)	ACT512	12	Max. 7.2	Min. 1.0	180±10%	66.7±10%	800	10 to 16

* Other pick-up voltage types are also available. Please contact us for details.

DIMENSIONS

1. Twin type (8 terminals)

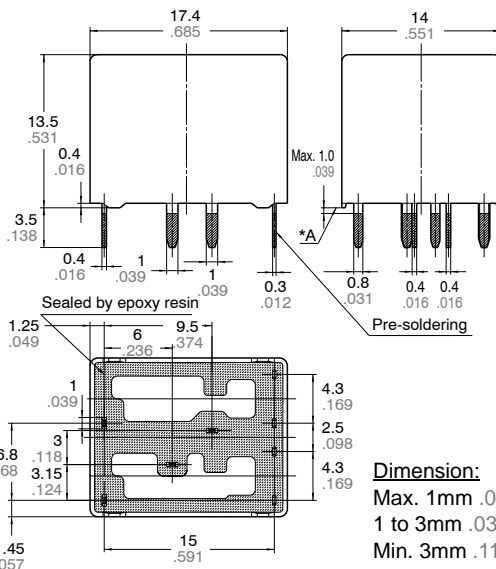

Dimension:
Max. 1mm .039 inch:
1 to 3mm .039 to .118 inch:
Min. 3mm .118 inch:

Tolerance
±0.1 ±.004
±0.2 ±.008
±0.3 ±.012

PC board pattern (Bottom view)

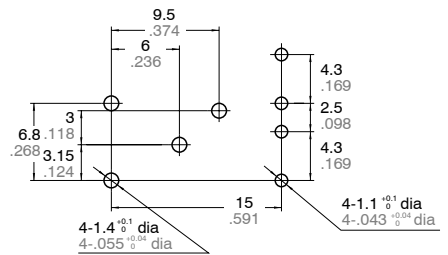

Tolerance: ±0.1 ±.004

Schematic (Bottom view)

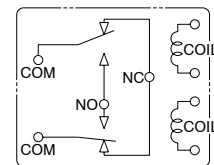

* Dimensions (thickness and width) of terminal specified in this catalog is measured before pre-soldering. Intervals between terminals is measured at A surface level.

2. Twin type (10 terminals)

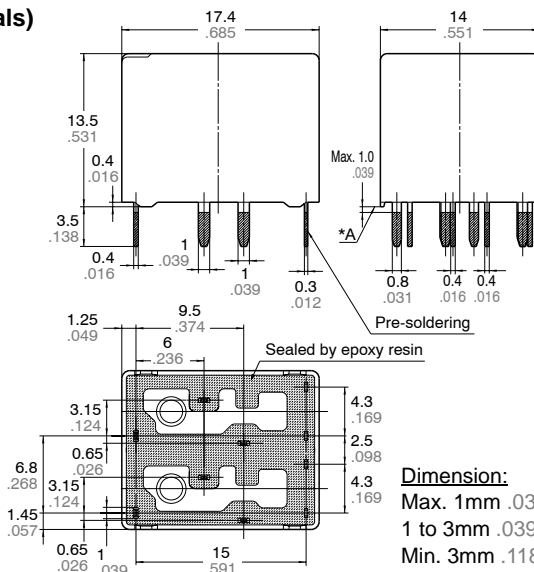

Dimension:
Max. 1mm .039 inch:
1 to 3mm .039 to .118 inch:
Min. 3mm .118 inch:

Tolerance
±0.1 ±.004
±0.2 ±.008
±0.3 ±.012

PC board pattern (Bottom view)

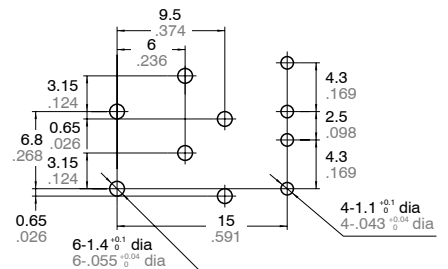

Tolerance: ±0.1 ±.004

Schematic (Bottom view)

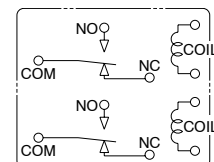

* Dimensions (thickness and width) of terminal specified in this catalog is measured before pre-soldering. Intervals between terminals is measured at A surface level.

3. Slim 1c type

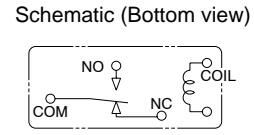
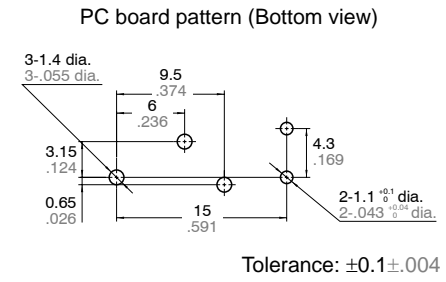
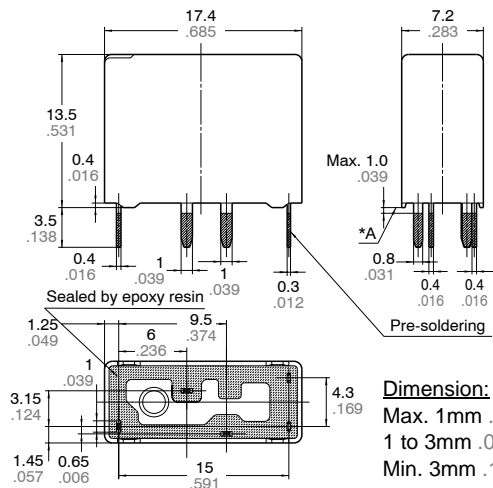

* Dimensions (thickness and width) of terminal specified in this catalog is measured before pre-soldering. Intervals between terminals is measured at A surface level.

EXAMPLE OF CIRCUIT

Forward/reverse control circuits of DC motor for power windows

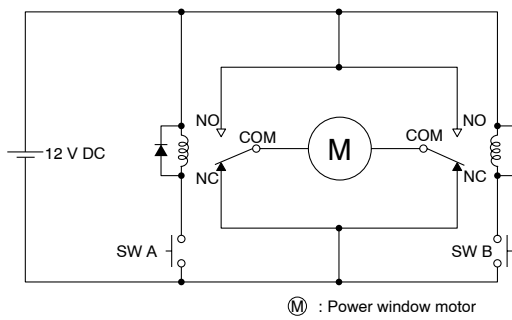

REFERENCE DATA

1-(1). Coil temperature rise (at room temperature)
 Sample: ACT212, 3pcs.
 Contact carrying current: 0A, 10A, 20A

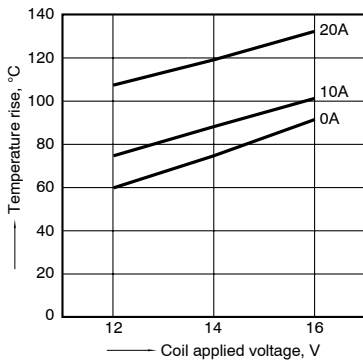

1-(2). Coil temperature rise (at 85°C 185°F)
 Sample: ACT212, 3pcs.
 Contact carrying current: 0A, 10A, 20A

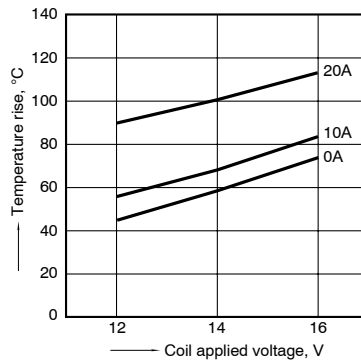

2. Max. switching capability (Resistive load)

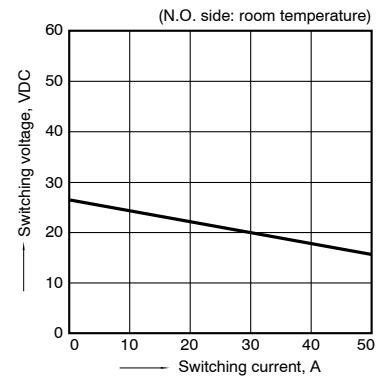

3. Ambient temperature and operating voltage range

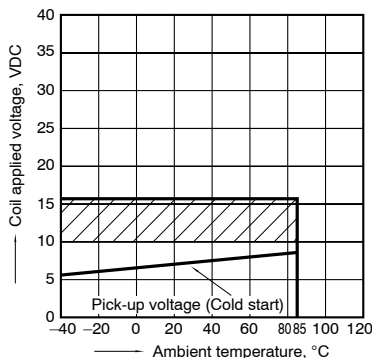

4. Distribution of pick-up and drop-out voltage
 Sample: ACT212, 40pcs.

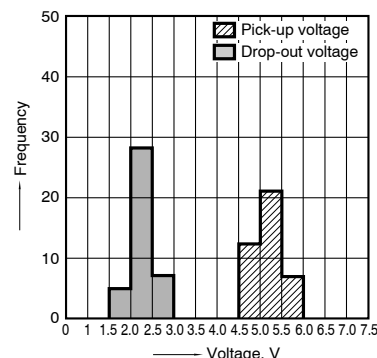

5. Distribution of operate and release time
 Sample: ACT212, 40pcs.
 * Without diode

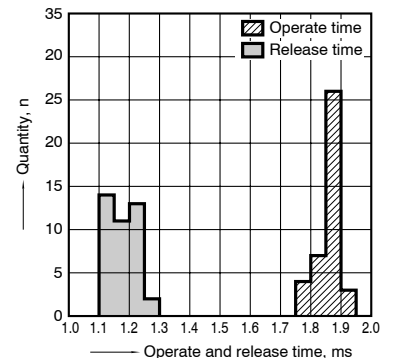

CT (ACT)

6-(1). Electrical life test (Motor free)

Sample: ACT212, 3pcs.
 Load: 5A steady, Inrush 25A, 14V DC
 Brake current: 13A 14V DC,
 Power window motor actual load (free condition)
 Operating frequency: (ON : OFF = 0.5s : 9.5s)
 Ambient temperature: Room temperature

Circuit:

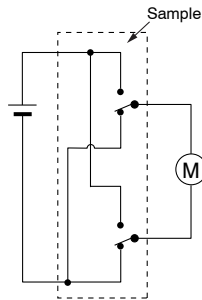

Change of pick-up and drop-out voltage

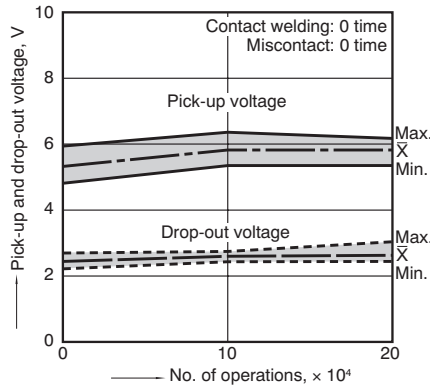

Change of contact resistance

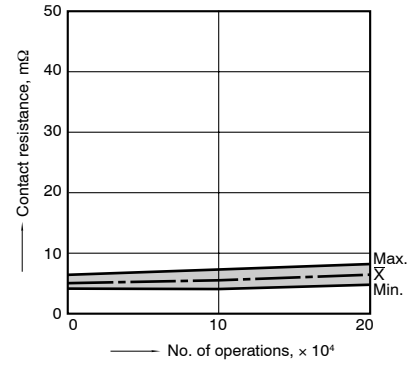

Load current waveform

Inrush current: 25A, Steady current: 6A
 Brake current: 13A

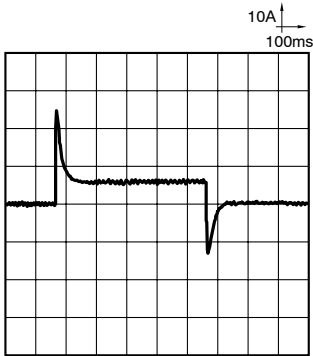

6-(2). Electrical life test (Motor lock)

Sample: ACT212, 3pcs.
 Load: 25A 14V DC
 Switching frequency: (ON : OFF = 0.5s : 9.5s)
 Ambient temperature: Room temperature

Circuit:

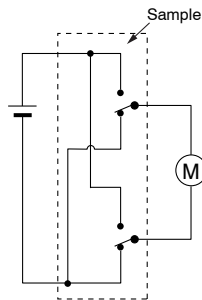

Change of pick-up and drop-out voltage

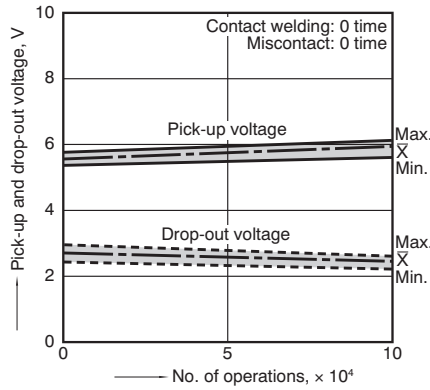

Change of contact resistance

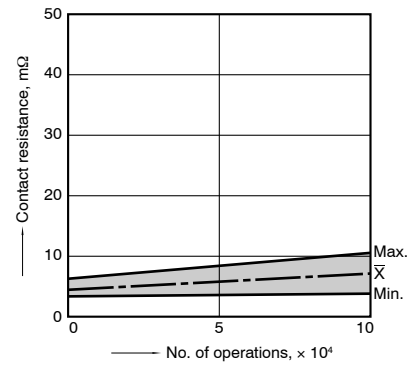

Load current waveform

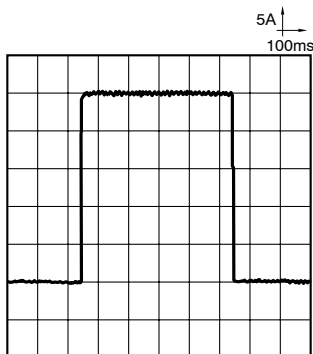

6-(3). Electrical life test (Motor lock)

Sample: ACT212, 3pcs.
 Load: 20A 14V DC,
 door lock motor actual load (Lock condition)
 Switching frequency: (ON : OFF = 0.3s : 19.7s)
 Ambient temperature: Room temperature

Circuit:

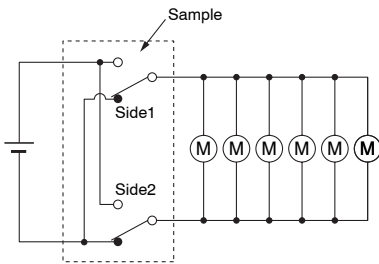

Change of pick-up and drop-out voltage

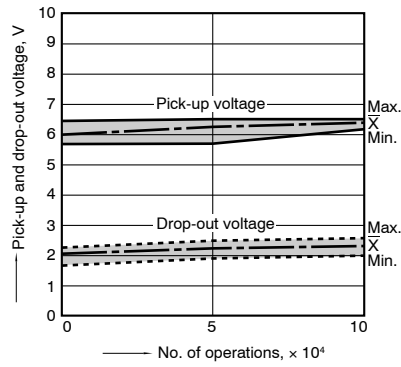

Change of contact resistance

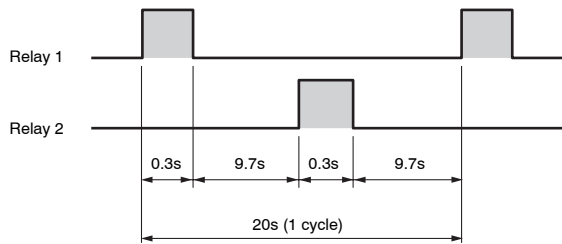
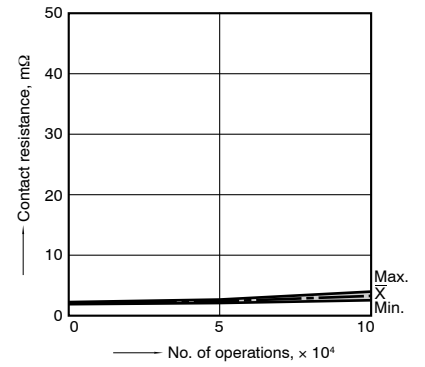

Load current waveform

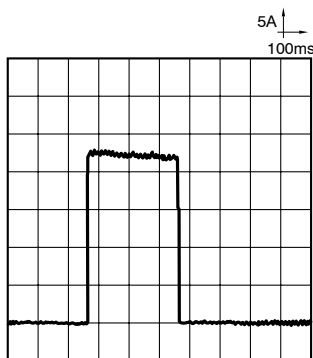

For Cautions for Use, see [Relay Technical Information](#).