

TAPE PACKING OPTIONS

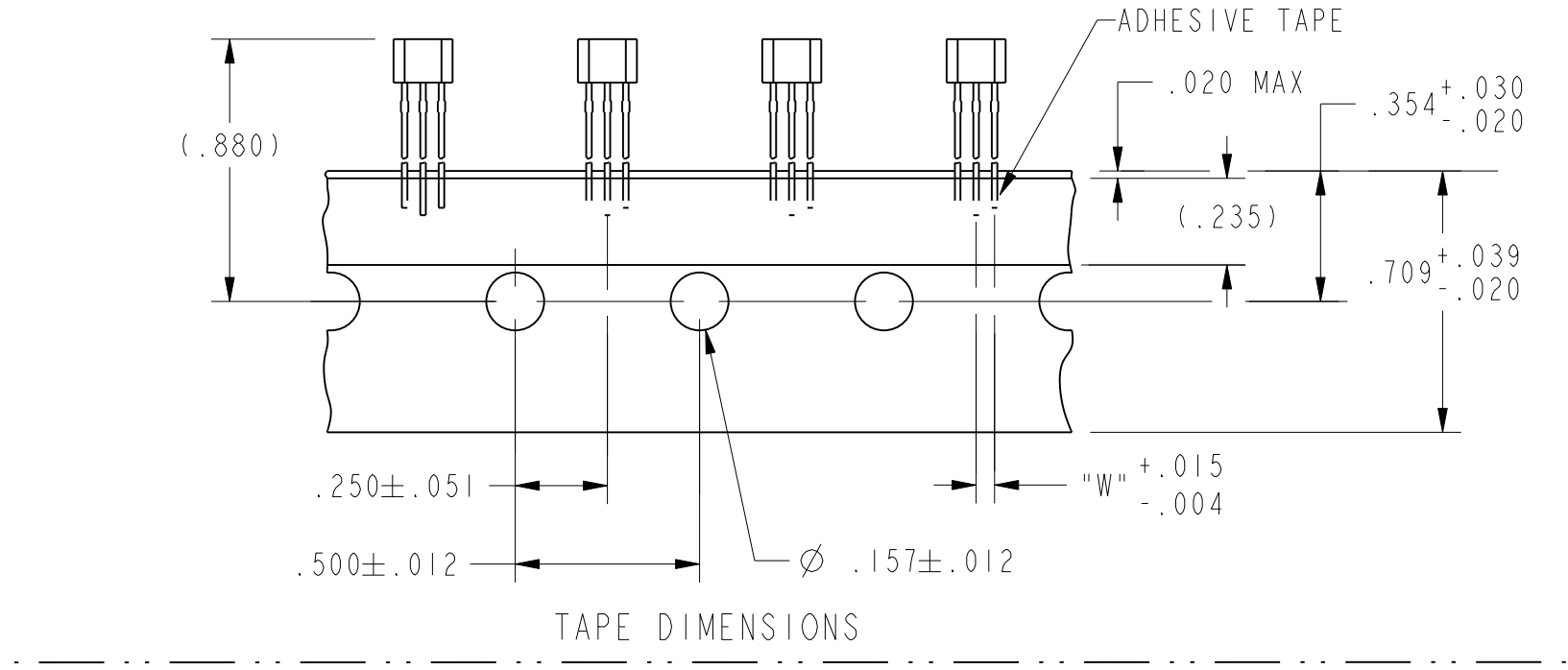

TAPE STYLE

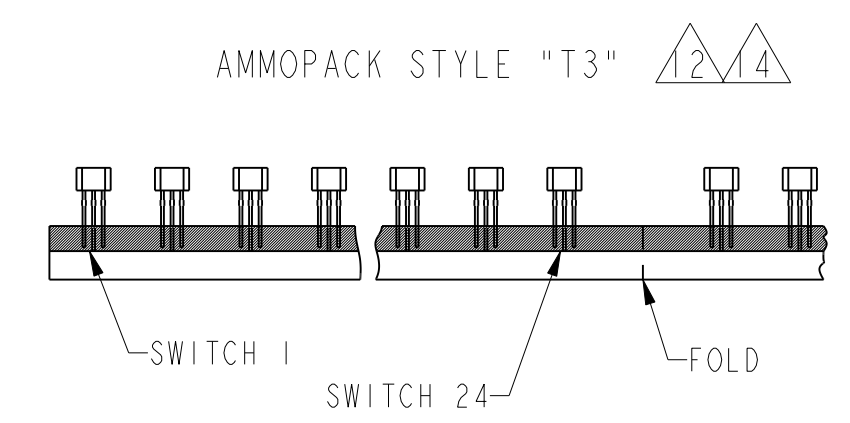
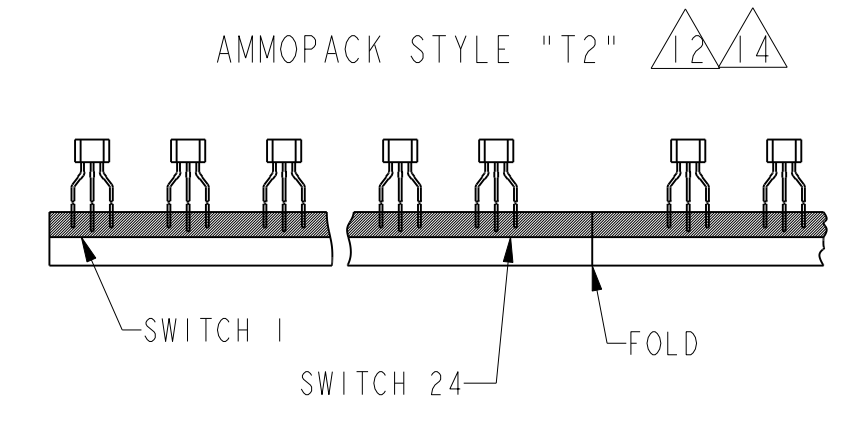

- NOTES
- 1 CENTERLINE OF HALL CELL
  - 2 THE + MAGNETIC FLUX IS IN THE DIRECTION SHOWN (THIS ASSUMES THE CONVENTION THAT THE DIRECTION OF THE EXTERNAL FLUX OF A MAGNET IS FROM THE NORTH TO THE SOUTH POLE OF THE MAGNET)
  - 3 - THE DEVICE CANNOT BE DAMAGED BY MAGNETIC OVERDRIVE
  - 4 - OUTPUT TYPE - RATIOMETRIC
  - 5 - LEADS MUST BE ADEQUATELY SUPPORTED DURING ANY FORMING/SHEERING OPERATION TO ASSURE THAT THE LEADS ARE NOT STRESSED WITHIN THE PLASTIC
  - 6 - PCB WAVE SOLDERING GUIDELINES ARE AS FOLLOWS:  
250°C PEAK FOR 10 S MAX OR 260°C PEAK FOR 5 S MAX.
  - 7 BURRS ARE ALLOWED ONLY IF FULL LENGTH OF LEADS WILL PASS THROUGH ∅.023 HOLE.
  - 8 LEAD REFERENCE DIMENSIONS DO NOT INCLUDE SOLDER THICKNESS
  - 9 DIMENSION REFERS TO THE LOCATION OF LEAD CENTERLINES AS THE EXIT THE PLASTIC PACKAGE
  - 10 - SOME COMBINATIONS OF BASIC LISTING AND PACKAGE OPTIONS MAY NOT BE AVAILABLE
  - 11 ABSOLUTE MAXIMUM RATINGS ARE THE EXTREME LIMITS THE DEVICE WILL MOMENTARILY WITHSTAND WITHOUT DAMAGE TO THE DEVICE. ELECTRICAL AND MAGNETIC CHARACTERISTICS ARE NOT GUARANTEED IF THE RATED VOLTAGE AND/OR CURRENTS ARE EXCEEDED NOR WILL THE DEVICE NECESSARILY OPERATE AT ABSOLUTE MAXIMUM RATINGS
  - 12 LEAD STRAIGHTNESS MAY BE DETERIORATED ON SOME UNITS BY BULK PACKAGING. APPLICATIONS HAVING A CRITICAL LEAD STRAIGHTNESS REQUIREMENT SHOULD USE A TAPE PACKAGING OPTION
  - 13 AMMOPACK STYLE "T2" & "T3": 24 SWITCHES BETWEEN FOLDS, SKIP 1 SPACE AT FOLD. MAY BE REFERRED TO AS "FAN FOLD"
  - 14 MOLDED PART DIMENSIONS DO NOT INCLUDE FLASH. FLASH IS LIMITED TO .005 MAX
  - 15 TAPE AND AMMOPACK PER EIA-468
  - 16 POCKET TAPE PER EIA-481

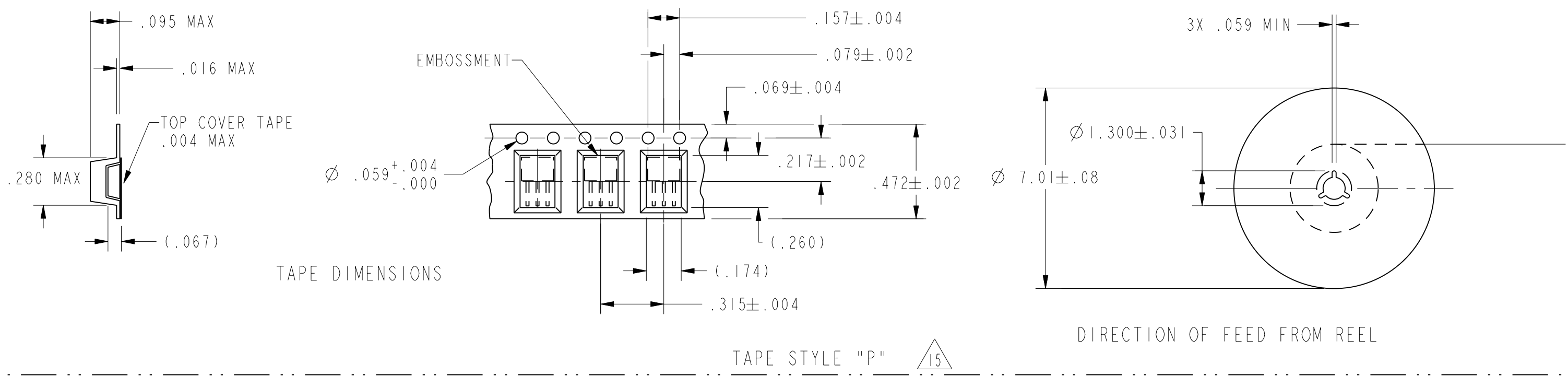

TAPE DIMENSIONS

TAPE STYLE "P"

CATALOG LISTING	TAPE STYLE	DIM "L"	DIM "W"	COMMENTS
SS495A	NONE	.590	.050	BULK - 1000/BAG
SS495A-T2	T2	.590	.100	5000/BOX
SS495A-T3	T3	.590	.050	5000/BOX
SS495A-S	NONE	.125	.050	BULK - 1000/BAG
SS495A-SP	P	.125	.050	1000/PACKET TAPE AND REEL
SS495A1	NONE	.590	.050	BULK - 1000/BAG
SS495A1-T2	T2	.590	.100	5000/BOX
SS495A1-T3	T3	.590	.050	5000/BOX
SS495A1-S	NONE	.125	.050	BULK - 1000/BAG
SS495A1-SP	P	.125	.050	1000/PACKET TAPE AND REEL
SS495A2	NONE	.590	.050	BULK - 1000/BAG
SS495A2-S	NONE	.125	.050	BULK - 1000/BAG
SS495A2-SP	P	.125	.050	1000/PACKET TAPE AND REEL
SS495A2-T2	T2	.590	.100	5000/BOX
SS495A2-T3	T3	.590	.050	5000/BOX
SS495A-L	NONE	.735	.050	BULK - 1000/BAG
SS495A1-L	NONE	.735	.050	BULK - 1000/BAG
SS495A2-L	NONE	.735	.050	BULK - 1000/BAG
SS495B	NONE	.590	.050	BULK - 1000/BAG
SS495B-T2	T2	.590	.100	5000/BOX
SS495B-T3	T3	.590	.050	5000/BOX
SS495B-S	NONE	.125	.050	BULK - 1000/BAG
SS495B-SP	P	.125	.050	1000/PACKET TAPE AND REEL

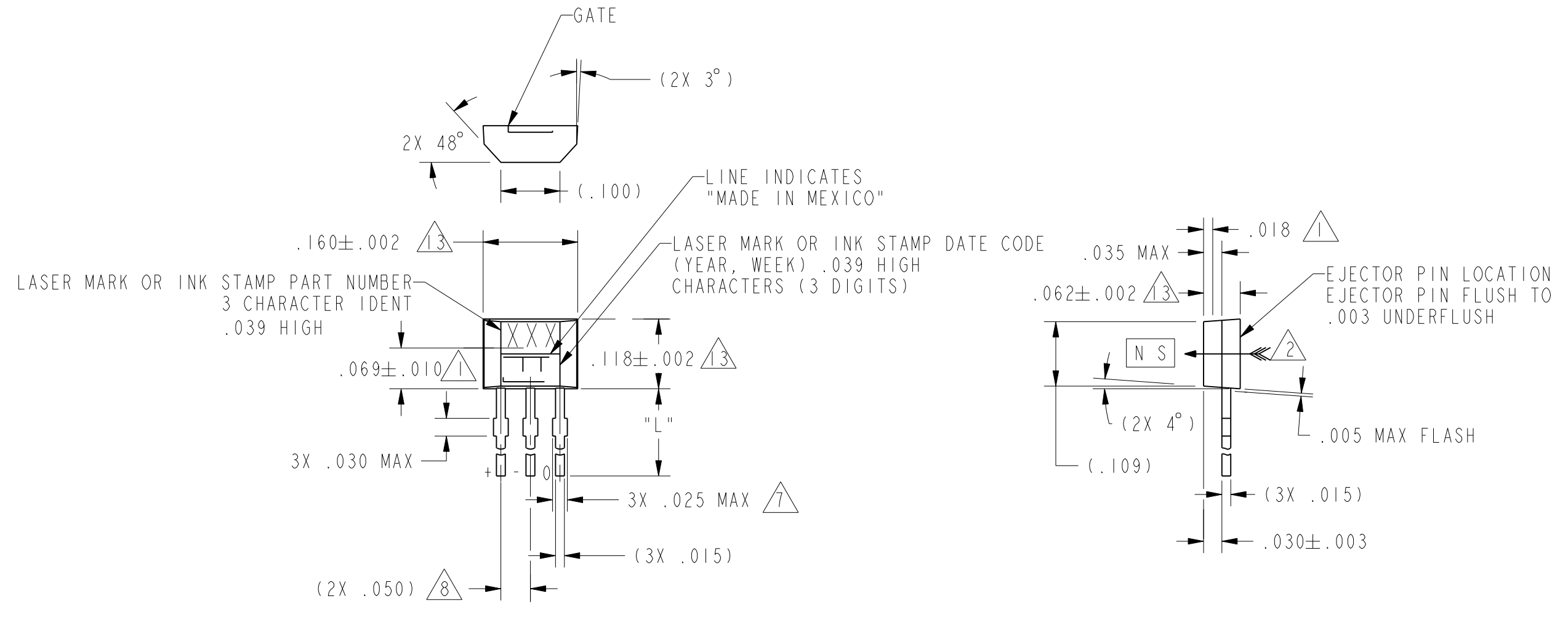

OPTIONAL SURFACE MOUNT LEAD STYLE

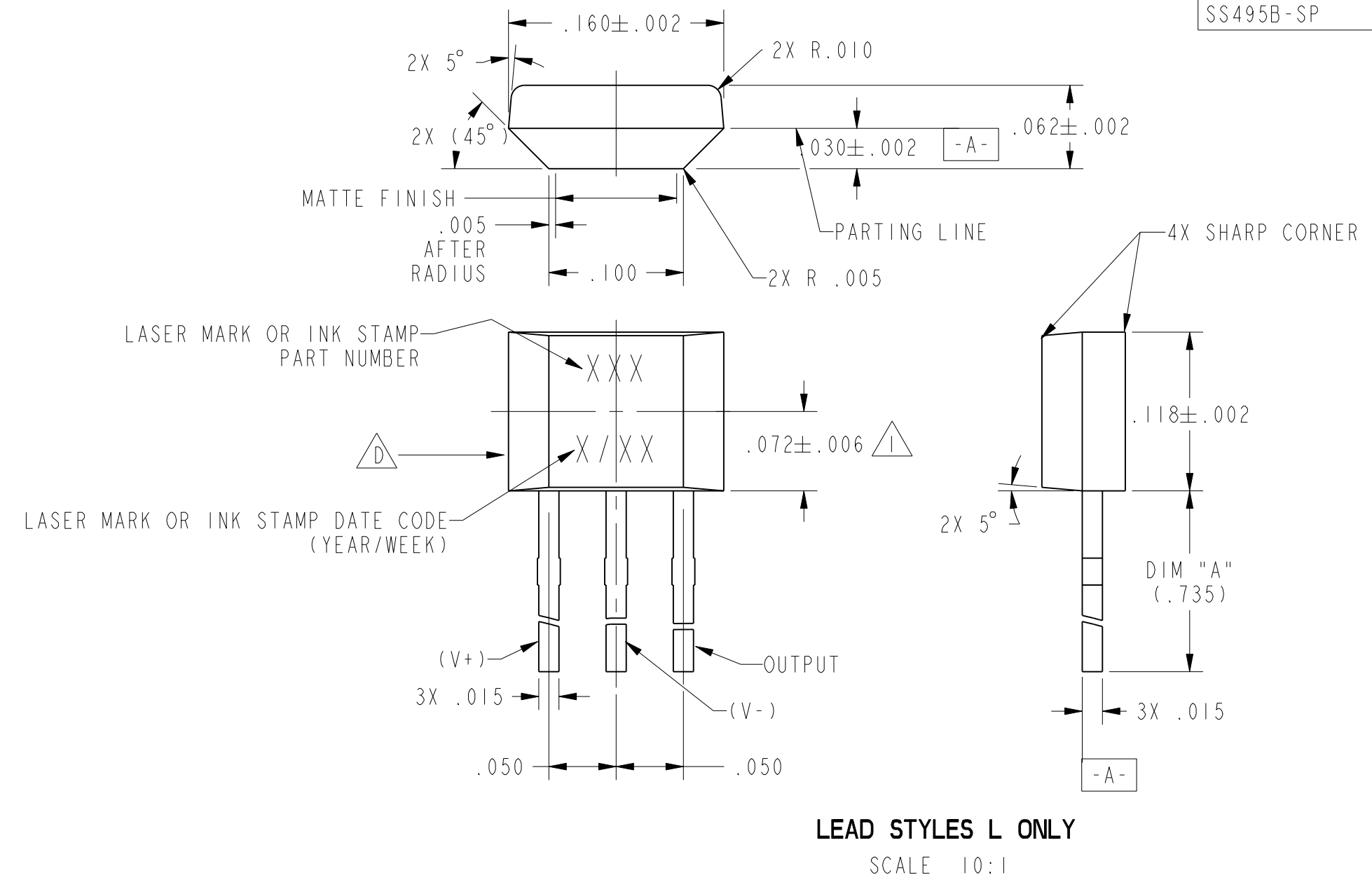
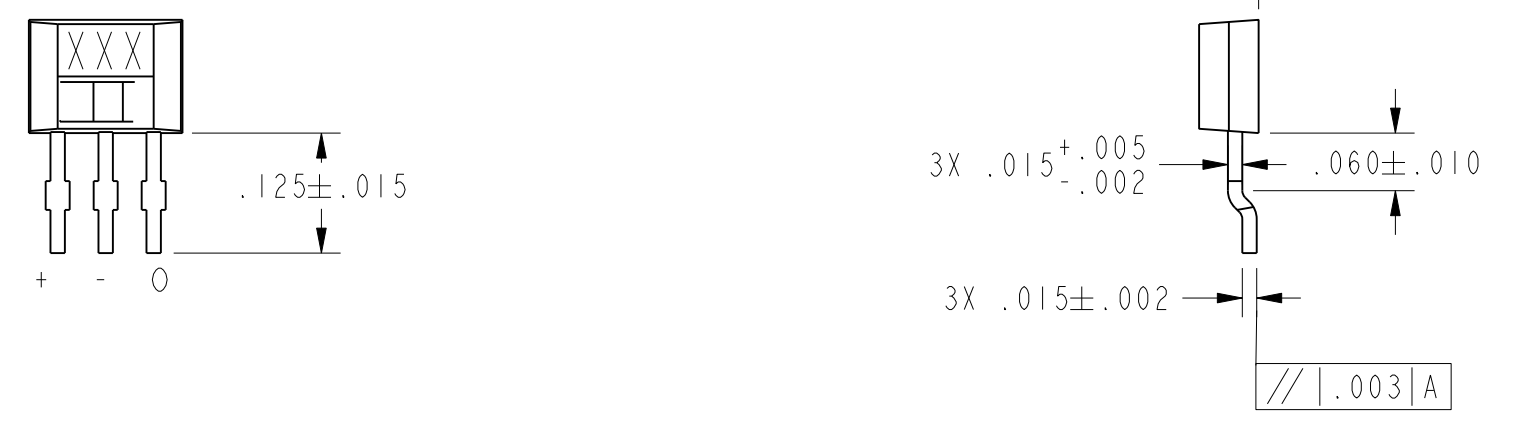

LEAD STYLES L ONLY  
SCALE 10:1

PTC/CAD 2D  
 DRAWING NUMBER  
 ISSUE  
 CHECK  
 APPROVALS  
 DATE  
 RELEASE NO. PR-21283  
 REVISIONS  
 14  
 1 OF 5  
 SS495 SERIES CHART 1  
 4 APR 02  
 26 OCT 01  
 14  
 1 OF 5  
 SS495 SERIES CHART 1  
 4 APR 02  
 26 OCT 01



THIS DRAWING COVERS A PROPRIETARY ITEM AND IS THE PROPERTY OF MICRO SWITCH, A DIVISION OF HONEYWELL. THIS DRAWING IS NOT TO BE COPIED OR USED WITHOUT THE APPROVAL OF MICRO SWITCH.  
 FED. MFG. CODE 91929  
**MICRO SWITCH**  
 a Honeywell Division  
**MINIATURE RATIOMETRIC LINEAR HALL EFFECT SENSOR**  
 CATALOG LISTING  
**SS495 SERIES CHART 1**

THIRD ANGLE PROJECTION

SCALE 5:1

DO NOT SCALE PRINT

UNLESS OTHERWISE SPECIFIED TOLERANCES ARE

ONE PLACE	(.0)	+.030
TWO PLACE	(.00)	+.015
THREE PLACE	(.000)	+.005

ANGLES  
+2°

WEIGHT

CHARACTERISTICS ARE AT  $V_s=5.0$  WITH 4.7K OUTPUT TO MINUS WITH  $T_A=-40^{\circ}\text{C}$  TO  $+125^{\circ}\text{C}$  UNLESS OTHERWISE SPECIFIED

SS495A

SS495 SERIES CHART 1

PARAMETER	CONDITIONS	MIN	TYP	MAX	UNITS
SENSITIVITY	$T_A = 25^{\circ}\text{C}$	3.00	3.125	3.25	mV/GAUSS
NULL	$T_A = 25^{\circ}\text{C}$	2.425	2.50	2.575	VOLTS
SUPPLY CURRENT	$T_A = 25^{\circ}\text{C}$		7	8.7	mA
OUTPUT CURRENT	SOURCE $V_s > 4.5$	1mA	1.5mA		
	SINK $V_s > 4.5$	.6mA	1.5mA		
	SINK $V_s > 5.0$	1mA	1.5mA		
RESPONSE TIME			3μS		
OUTPUT VOLTAGE SWING	VOM -	.4	.2		VOLTS
	VOM +	$V_s - .4$	$V_s - .2$		VOLTS
B LIMITS FOR LINEAR OPERATION	-B MAX	-600	-670		GAUSS
	+B MAX	+600	+670		GAUSS
$V_{null}$ DRIFT	$B = 0, T_A = 25^{\circ}\text{C TO } 125^{\circ}\text{C}$	-.06		+.06	% / °C
$V_{null}$ DRIFT	$B = 0, T_A = -125^{\circ}\text{C TO } +150^{\circ}\text{C}$	-.08		+.08	% / °C
SENSITIVITY DRIFT	$T_A = +25^{\circ}\text{C TO } +150^{\circ}\text{C}$	-.01		+.05	% / °C
SENSITIVITY DRIFT	$T_A = -40^{\circ}\text{C TO } +25^{\circ}\text{C}$	0		+.06	% / °C
LINEARITY	$B = -600 \text{ TO } +600$	0	-1.0	-1.5	% OF SPAN
SUPPLY VOLTAGE	$-40^{\circ}\text{C TO } +125^{\circ}\text{C}$	4.5	5.0	10.5	VOLTS
OPERATING TEMP	SEE MAX TEMPERATURE CHART	-40		+150	°C

BLOCK DIAGRAM CURRENT SINKING OR SOURCING OUTPUT

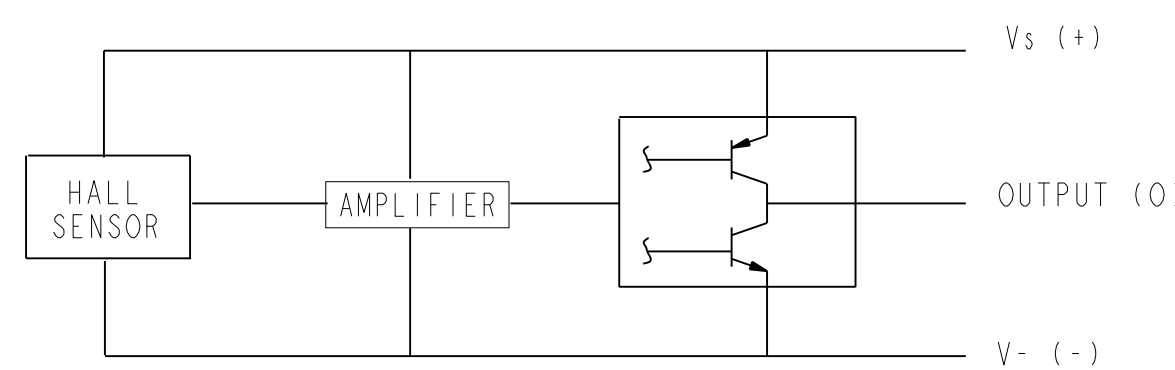

ABSOLUTE MAXIMUM CHARACTERISTICS

CHARACTERISTIC	SYMBOL	TEST CONDITION	MIN	MAX	UNITS
SUPPLY VOLTAGE	$V_{cc}$		-0.5	11	V
OUTPUT VOLTAGE	$V_{out}$		-0.5	11	V
OUTPUT CURRENT	$I_{out}$	SOURCE OR SINK		10	mA
TEMPERATURE	$T_A$	OPERATING	-55	150	°C
	$T_s$	STORAGE ( $V_{cc}=0$ )	-55	165	°C

NULL SHIFT VERSUS TEMPERATURE

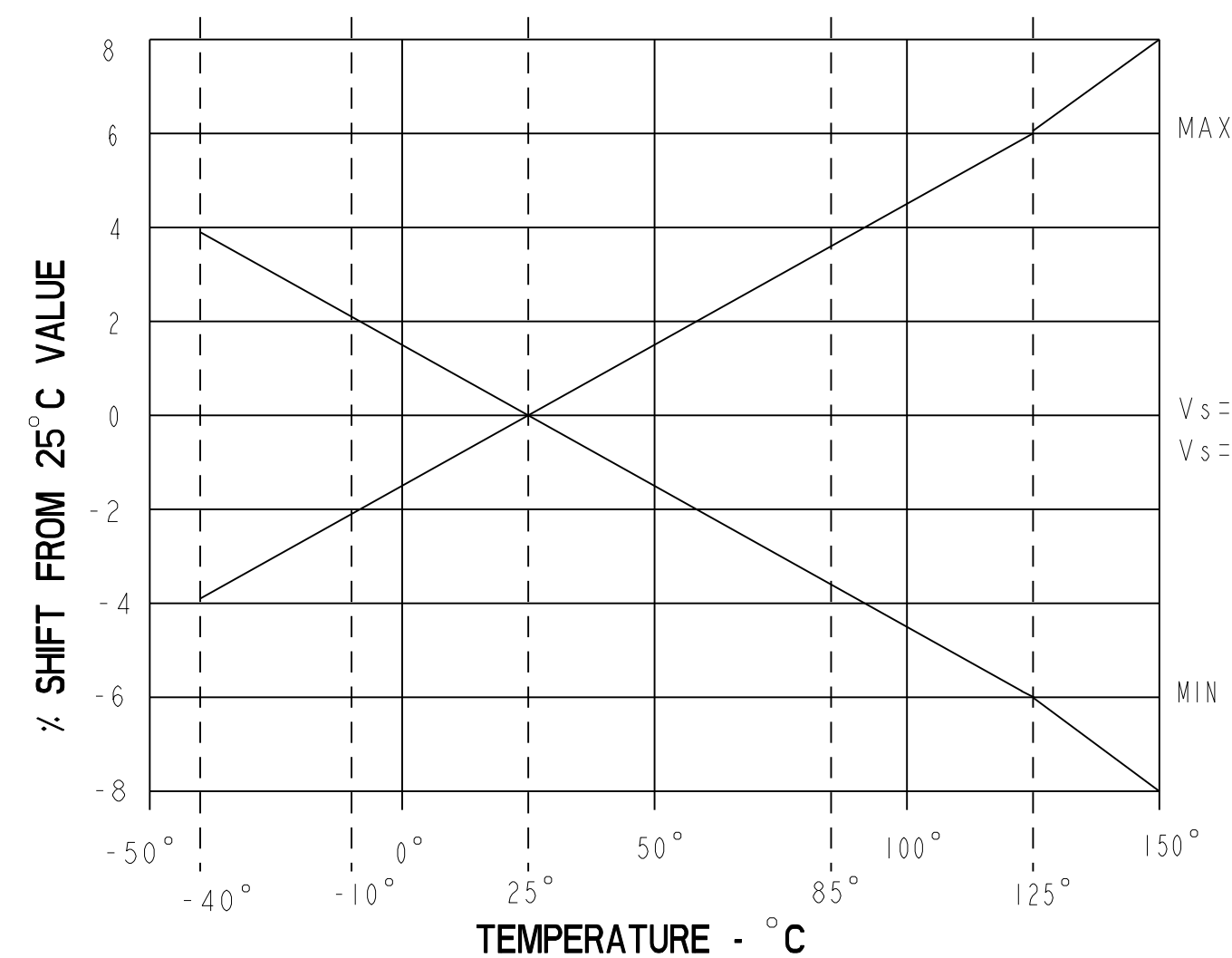

RATIO OF  $V_{null}$  TO  $V_s$

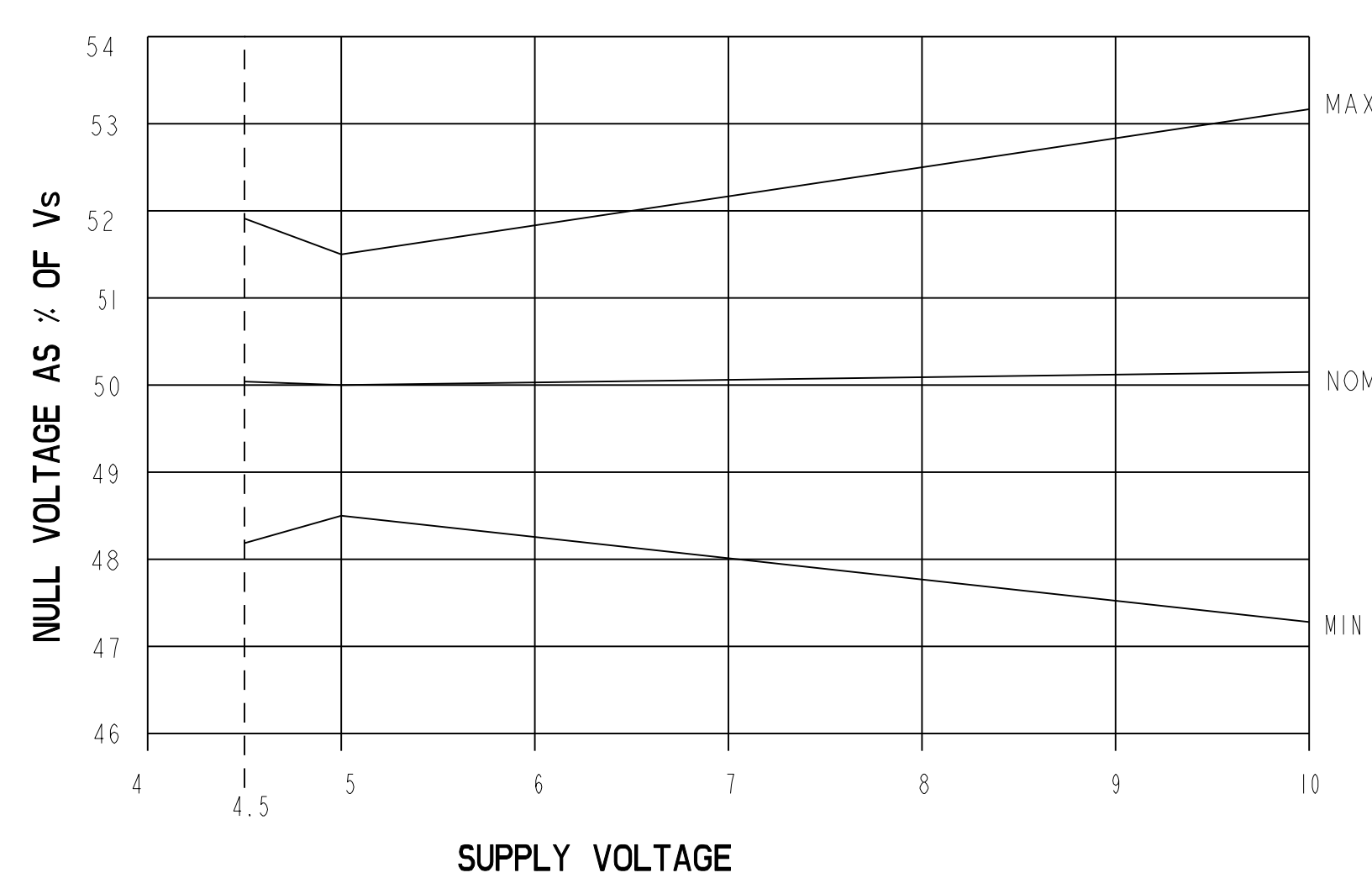

SENSITIVITY SHIFT VERSUS TEMPERATURE

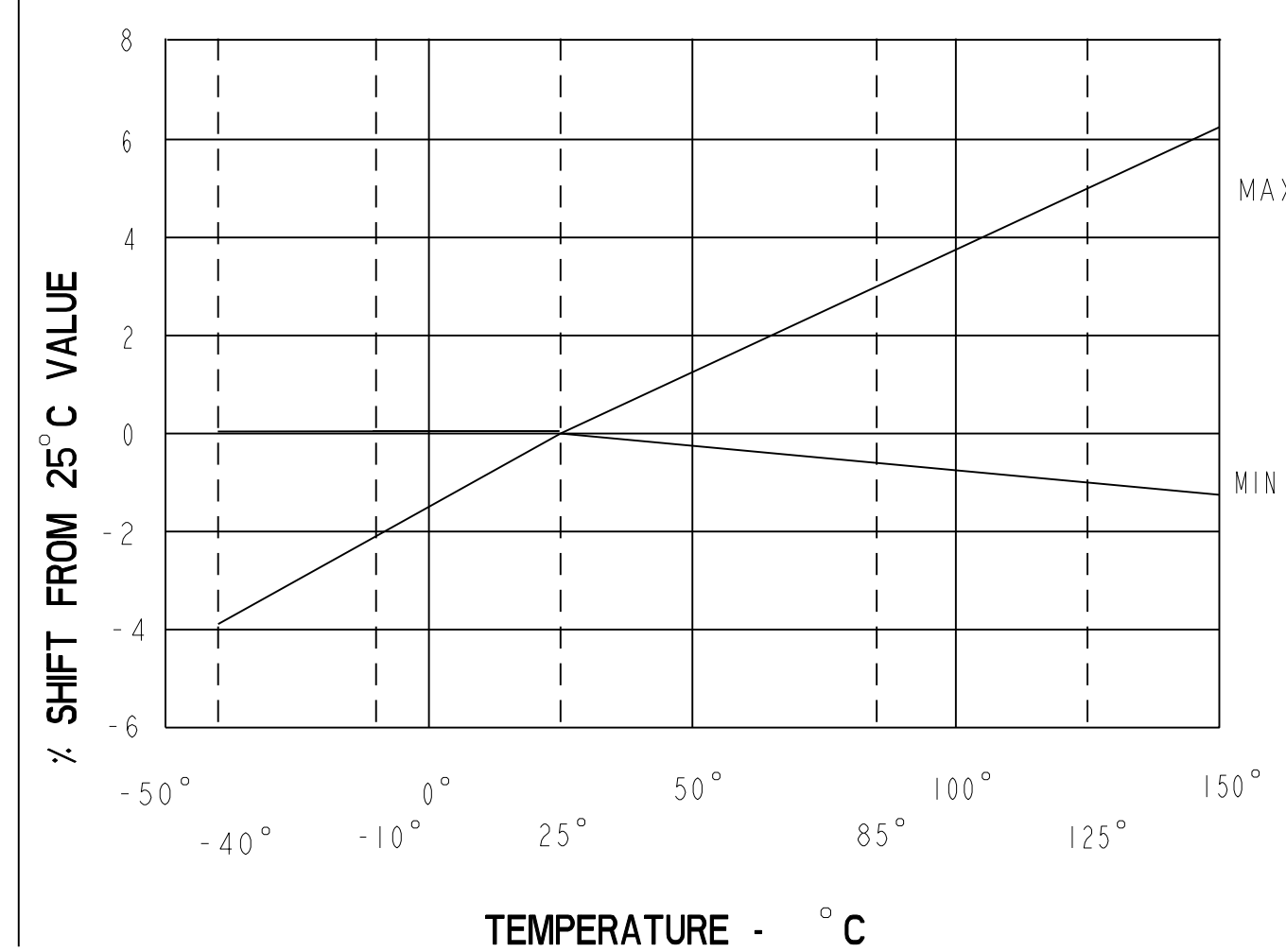

SENSITIVITY/V VERSUS  $V_s$   
(mV/GAUSS/VOLT)

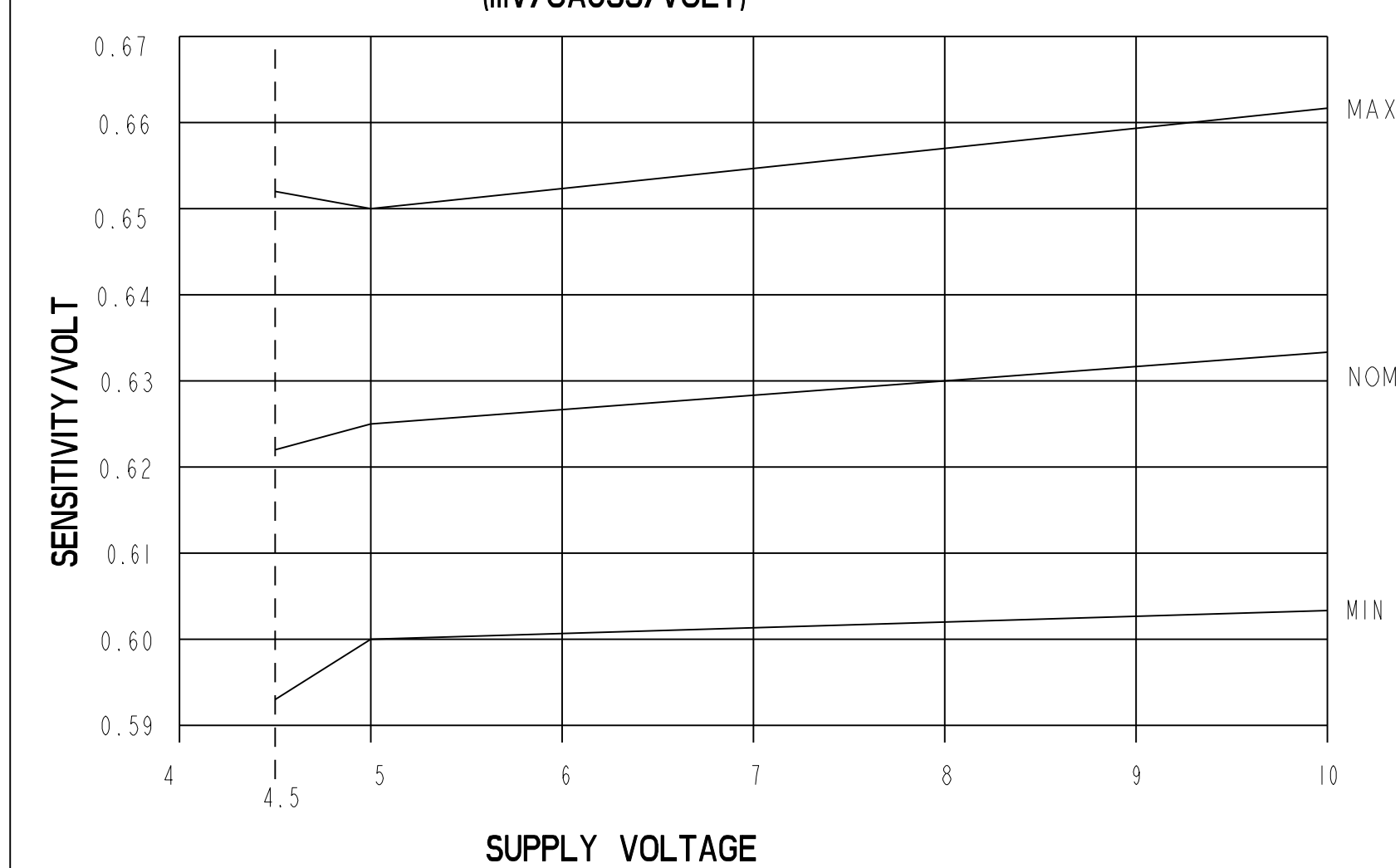

LINEARITY VERSUS  $V_s$   
END POINT OF SPAN METHOD

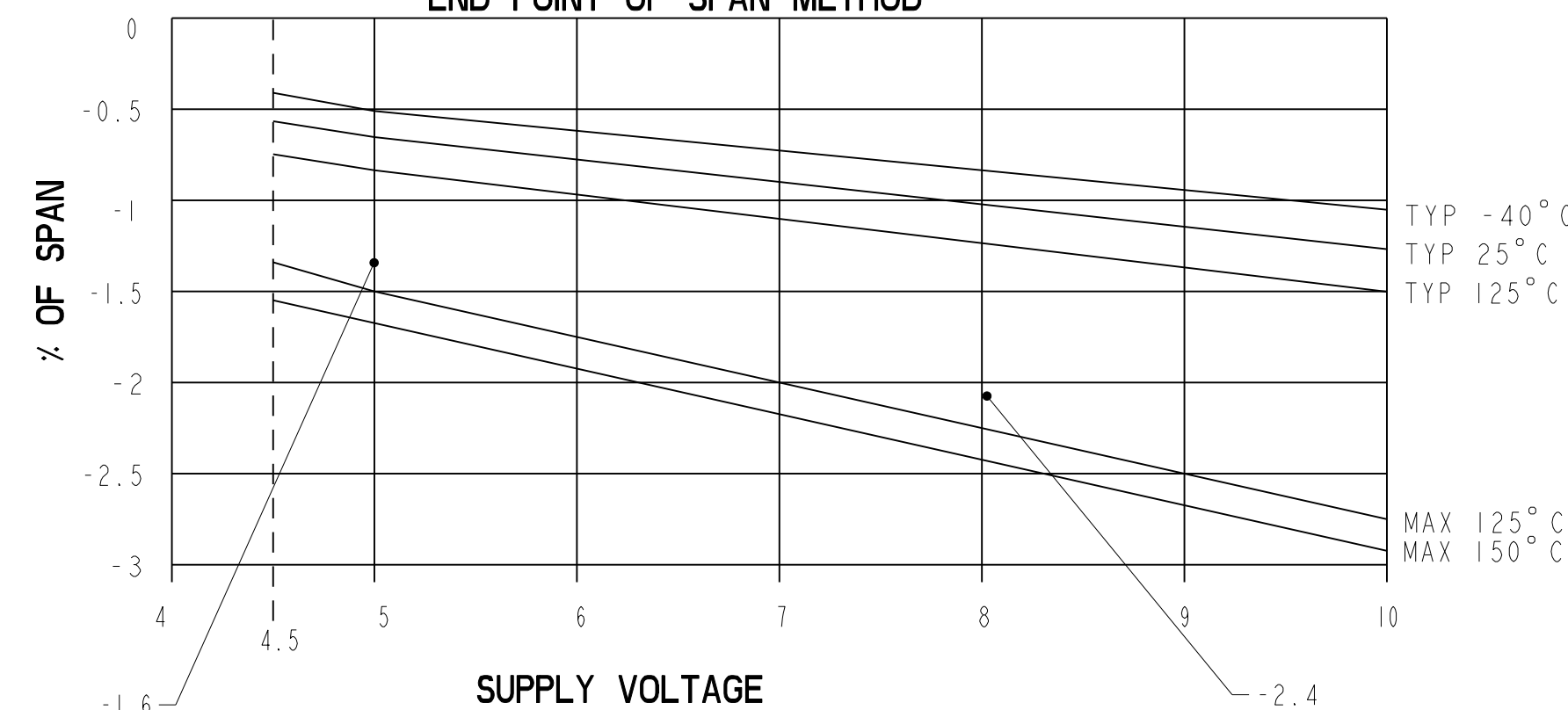

TRANSFER CHARACTERISTICS AT  $V_s=5.0$  VDC

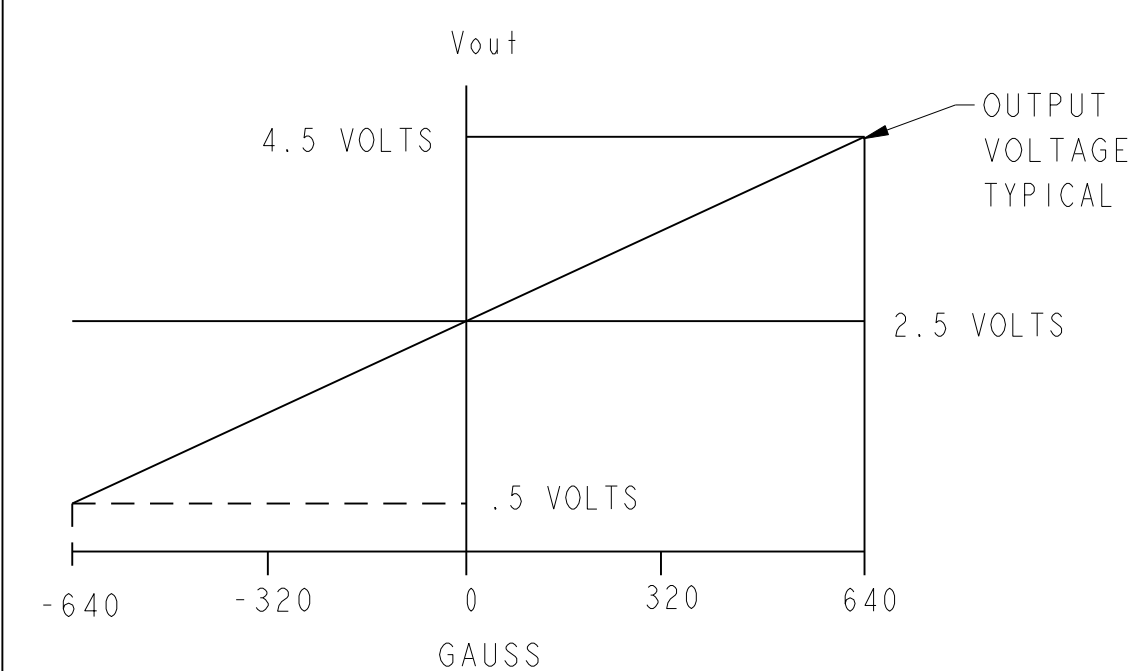

SUPPLY CURRENT VERSUS TEMPERATURE

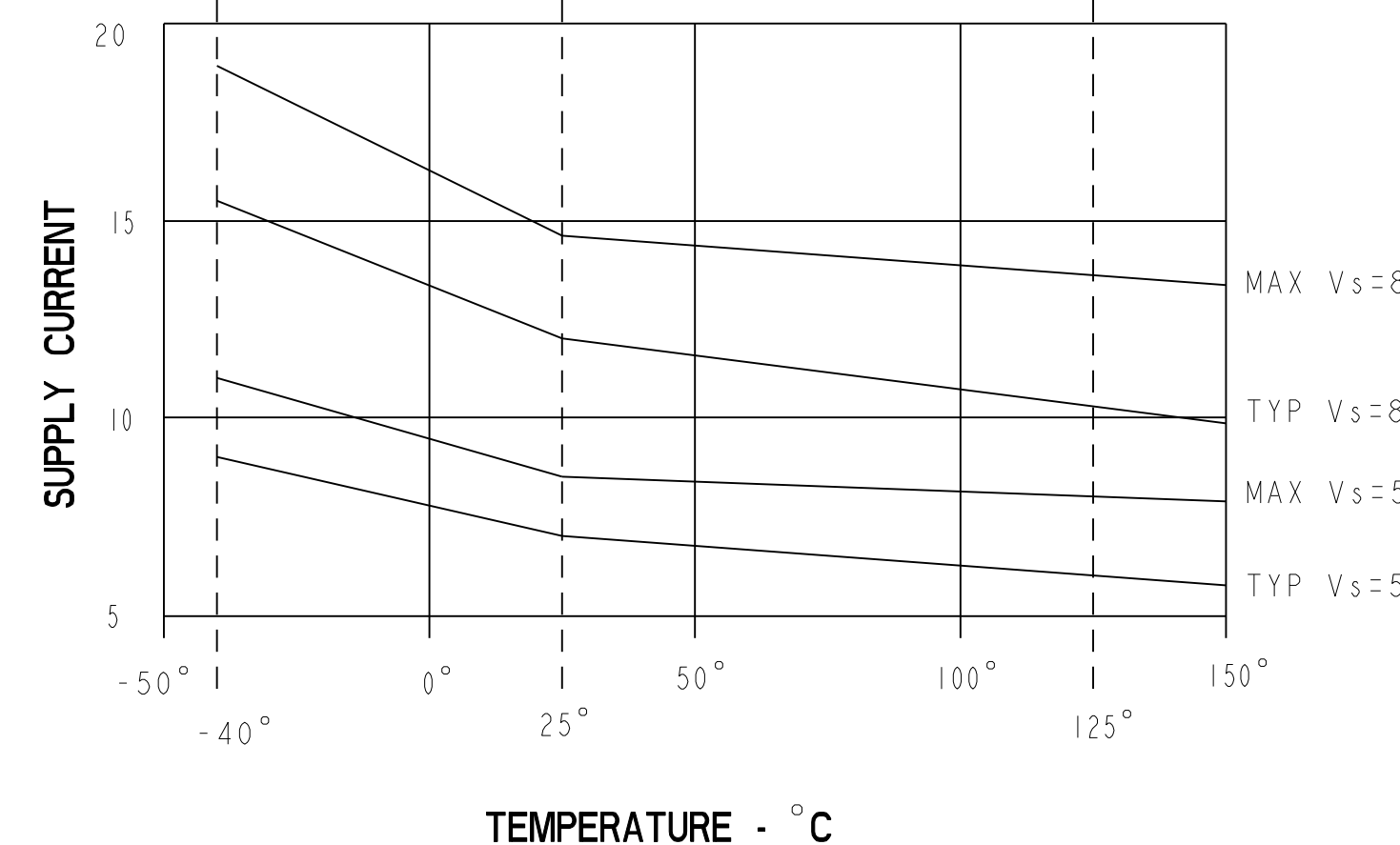

TYPICAL FREQUENCY RESPONSE  
RL=33k PARALLEL WITH 100pF

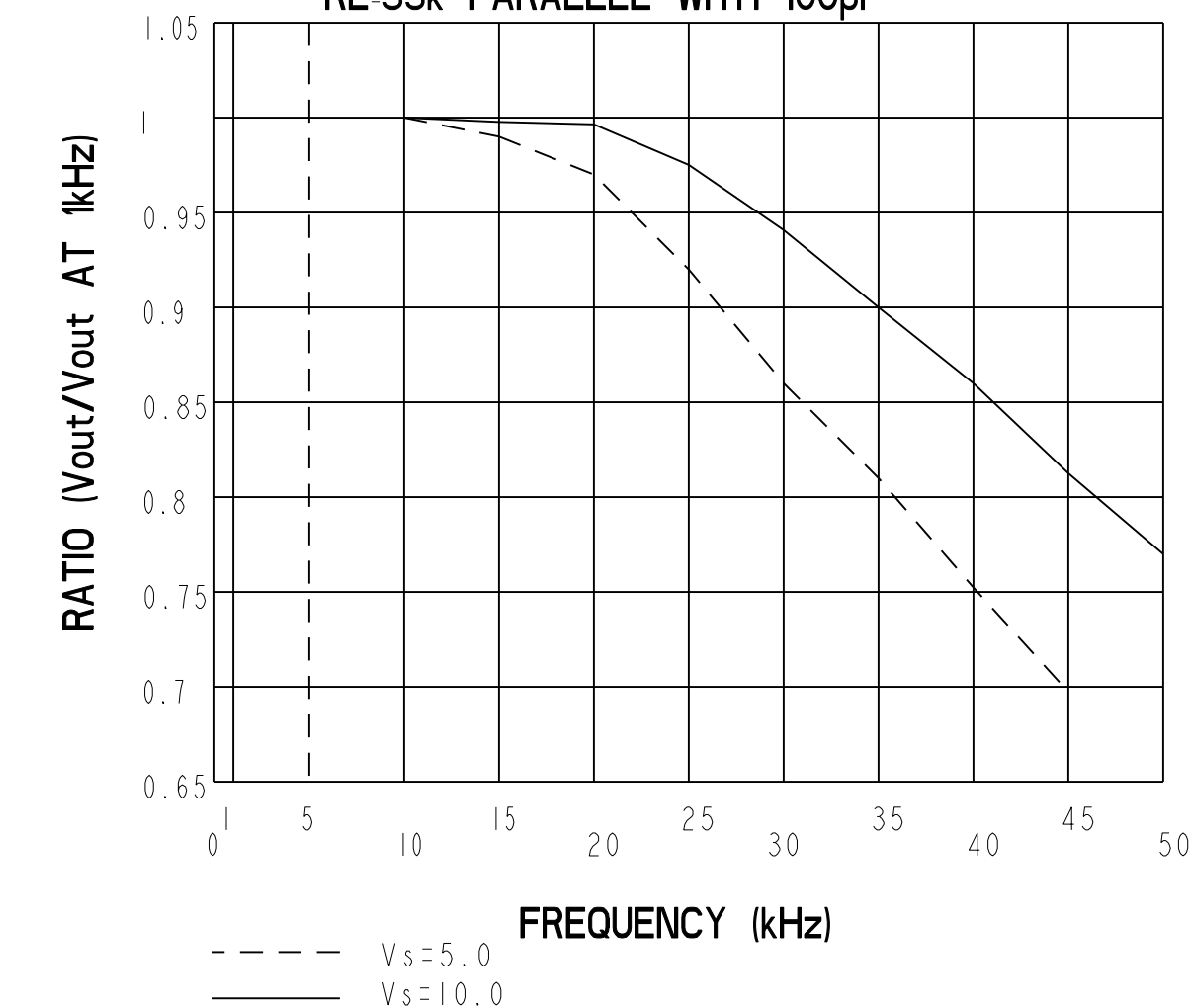

MAXIMUM ALLOWABLE AMBIENT TEMPERATURE

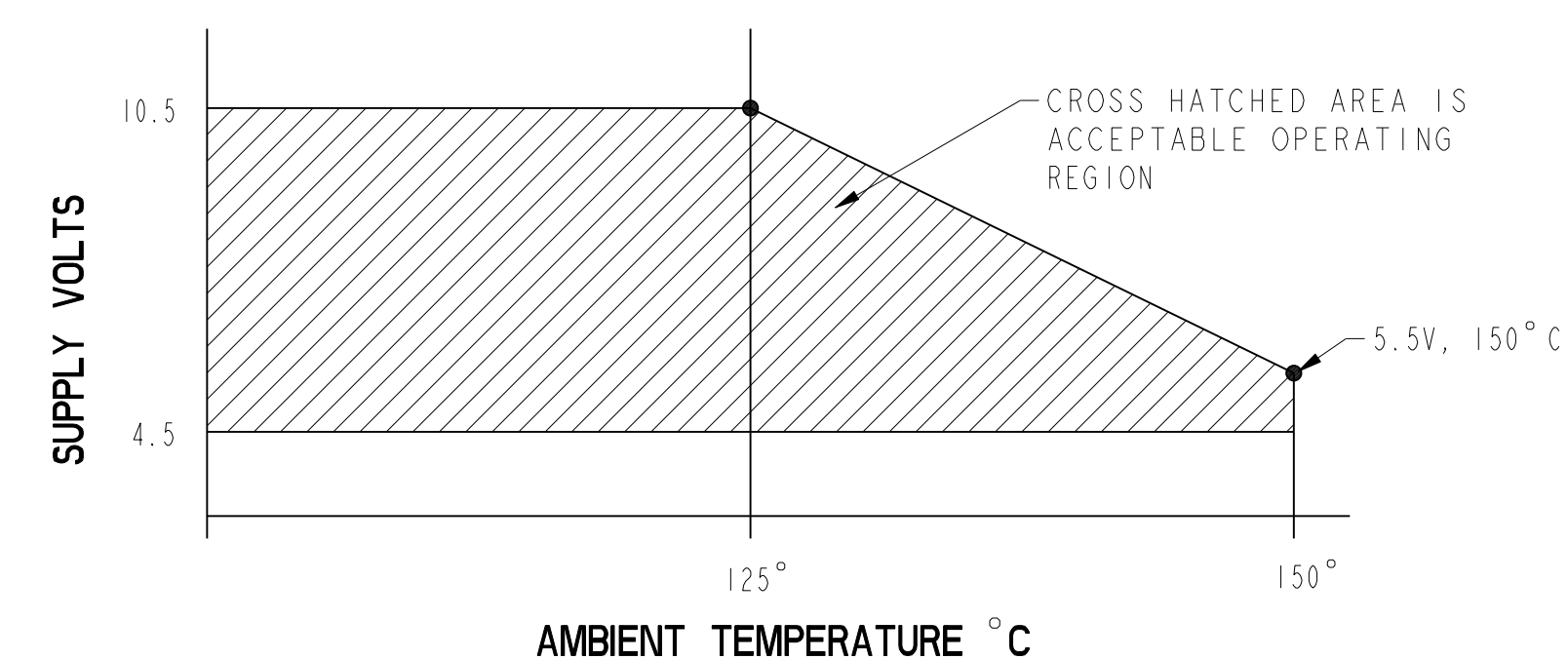

THIS DRAWING COVERS A PROPRIETARY ITEM AND IS THE PROPERTY OF MICRO SWITCH, A DIVISION OF HONEYWELL. THIS DRAWING IS NOT TO BE COPIED OR USED WITHOUT THE APPROVAL OF MICRO SWITCH.  
FED. MFG. CODE 91929  
CATALOG LISTING  
**MICRO SWITCH**  
a Honeywell Division  
**MINIATURE RATIO-METRIC  
LINEAR HALL EFFECT SENSOR**  
**SS495 SERIES CHART 1**

THIRD ANGLE PROJECTION	
SCALE	NONE
DO NOT SCALE PRINT	
UNLESS OTHERWISE SPECIFIED TOLERANCES ARE	
ONE PLACE	(.0) +.030
TWO PLACE	(.00) +.015
THREE PLACE	(.000) +.005
ANGLES	+2°
WEIGHT	

ANSI Y14.5M-1982 APPLIES

PTC/CAD 2D  
 DRAWN: C.S.L.  
 CHECKED: L.A.  
 APPROVED: S.A.V.  
 DATE: 4 APR 02  
 RELEASE NO. PR-21283  
 REVISIONS:  
 14  
 ISSUE: 14  
 DRAWING NUMBER: 14  
 PAGE: 2 OF 5  
 RELEASE NO. PR-21283  
 REVISIONS: 14  
 ISSUE: 14  
 DRAWING NUMBER: 14  
 PAGE: 2 OF 5  
 RELEASE NO. PR-21283  
 REVISIONS: 14  
 ISSUE: 14  
 DRAWING NUMBER: 14  
 PAGE: 2 OF 5  
 RELEASE NO. PR-21283

CHARACTERISTICS ARE AT  $V_s=5.00$  WITH 4.7K OUTPUT TO MINUS WITH  $T_A = -40^\circ\text{C}$  TO  $+125^\circ\text{C}$  UNLESS OTHERWISE SPECIFIED

SS495A1

SS495 SERIES CHART 1

PARAMETER	CONDITIONS	MIN	TYP	MAX	UNITS
SENSITIVITY	$T_A = 25^\circ\text{C}$	3.031	3.125	3.219	mV/GAUSS
NULL	$T_A = 25^\circ\text{C}$	2.425	2.50	2.575	VOLTS
SUPPLY CURRENT	$T_A = 25^\circ\text{C}$		7	8.7	mA
OUTPUT CURRENT SOURCE	$V_s > 4.5$	1mA	1.5mA		
	SINK	$V_s > 4.5$	.6mA	1.5mA	
	SINK	$V_s > 5.0$	1mA	1.5mA	
RESPONSE TIME			3μS		
OUTPUT VOLTAGE SWING	VOM -		.4	.2	VOLTS
	VOM +	+B APPLIED	$V_s - .4$	$V_s - .2$	VOLTS
B LIMITS FOR LINEAR OPERATION	-B MAX	-600	-670		GAUSS
	+B MAX	+600	+670		GAUSS
$V_{null}$ DRIFT	$B = 0, T_A = 25^\circ\text{C}$ TO $125^\circ\text{C}$	-.04		+.04	% / °C
$V_{null}$ DRIFT	$B = 0, T_A = +125^\circ\text{C}$ TO $+150^\circ\text{C}$	-.08		+.08	% / °C
SENSITIVITY DRIFT	$T_A = +25^\circ\text{C}$ TO $+150^\circ\text{C}$	-.01		+.05	% / °C
SENSITIVITY DRIFT	$T_A = -40^\circ\text{C}$ TO $+25^\circ\text{C}$	0		+.06	% / °C
LINEARITY	$B = -600$ TO $+600$	0	-1.0	-1.5	% OF SPAN
SUPPLY VOLTAGE	$-40^\circ\text{C}$ TO $+125^\circ\text{C}$	4.5	5.0	10.5	VOLTS
OPERATING TEMP	SEE MAX TEMPERATURE CHART	-40		+150	°C

BLOCK DIAGRAM CURRENT SINKING OR SOURCING OUTPUT

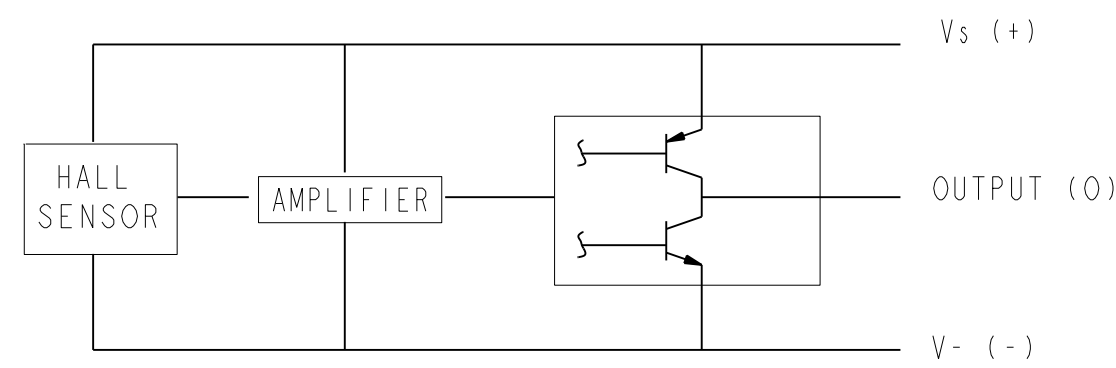

ABSOLUTE MAXIMUM CHARACTERISTICS

CHARACTERISTIC	SYMBOL	TEST CONDITION	MIN	MAX	UNITS
SUPPLY VOLTAGE	$V_{cc}$		-0.5	11	V
OUTPUT VOLTAGE	$V_{out}$		-0.5	11	V
OUTPUT CURRENT	$I_{out}$	SOURCE OR SINK		10	mA
TEMPERATURE	$T_A$	OPERATING	-55	150	°C
	$T_s$	STORAGE ( $V_{cc}=0$ )	-55	165	°C

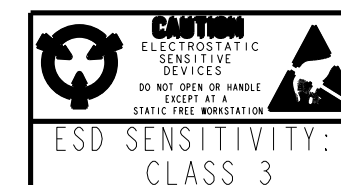
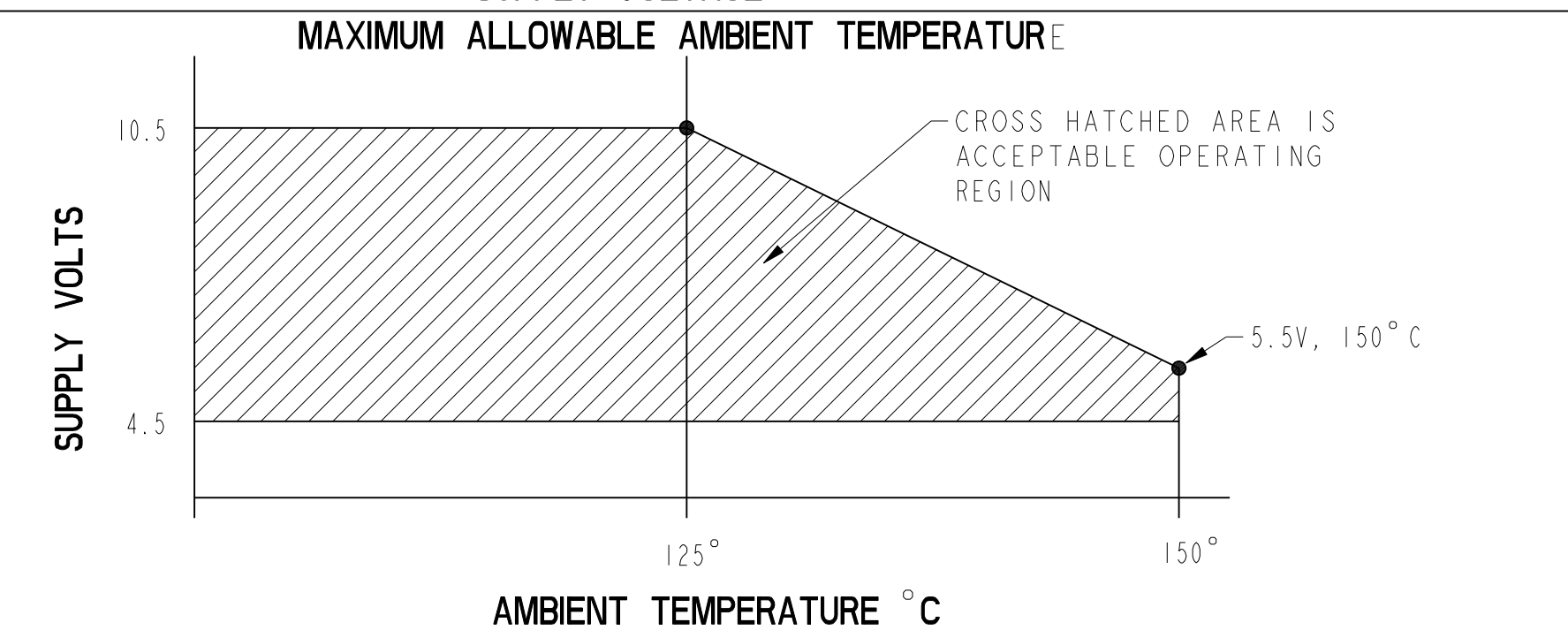
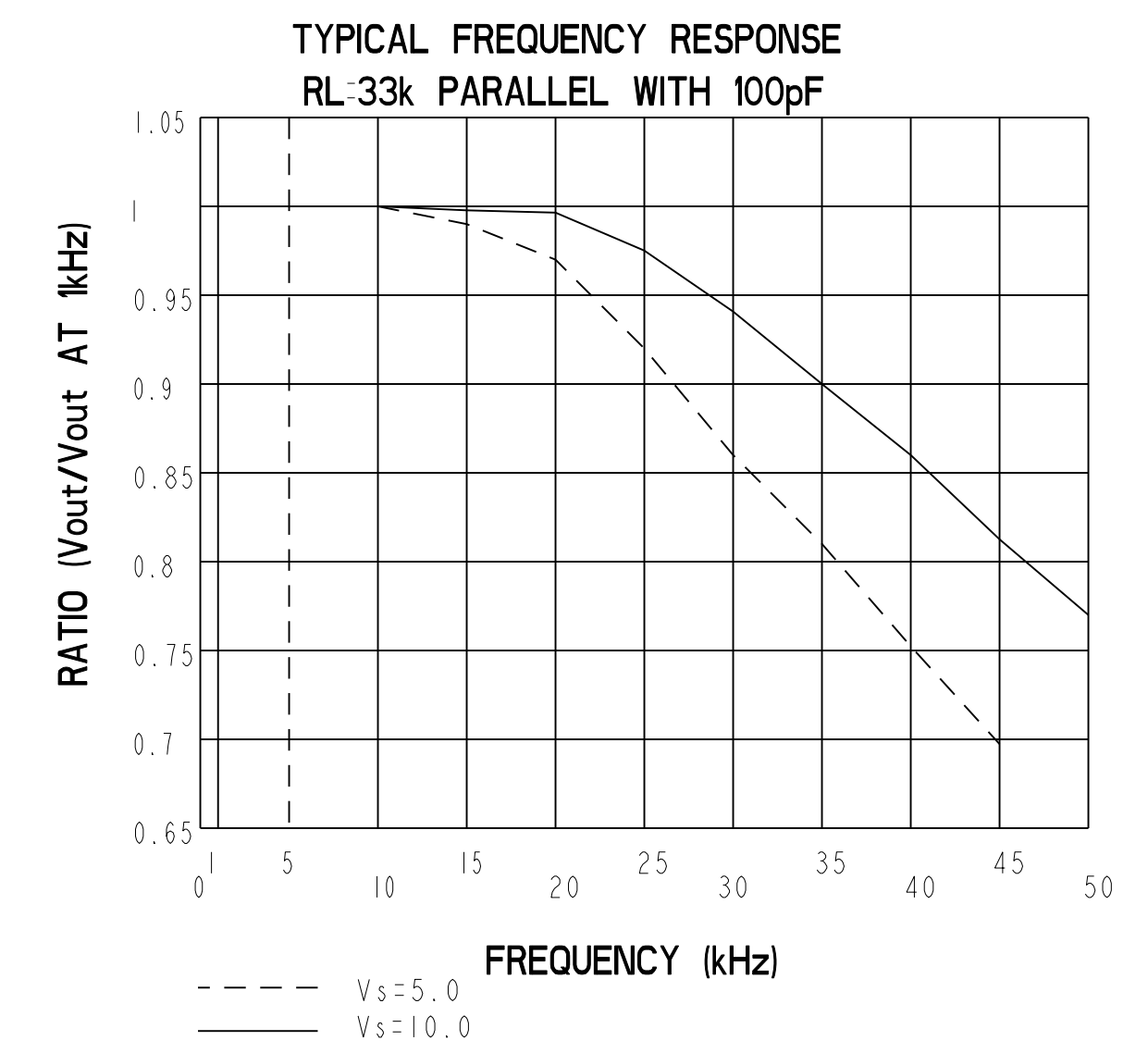
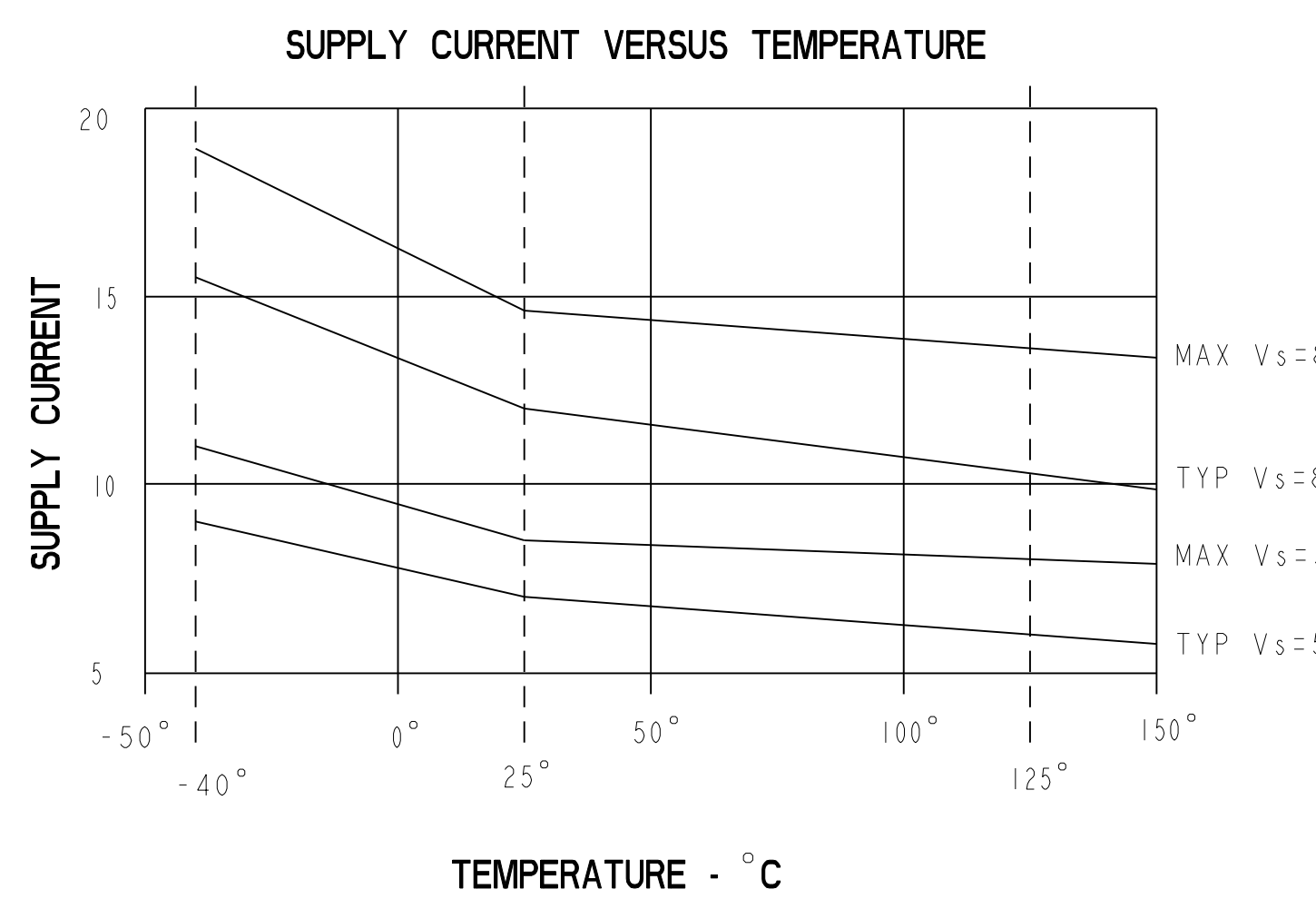
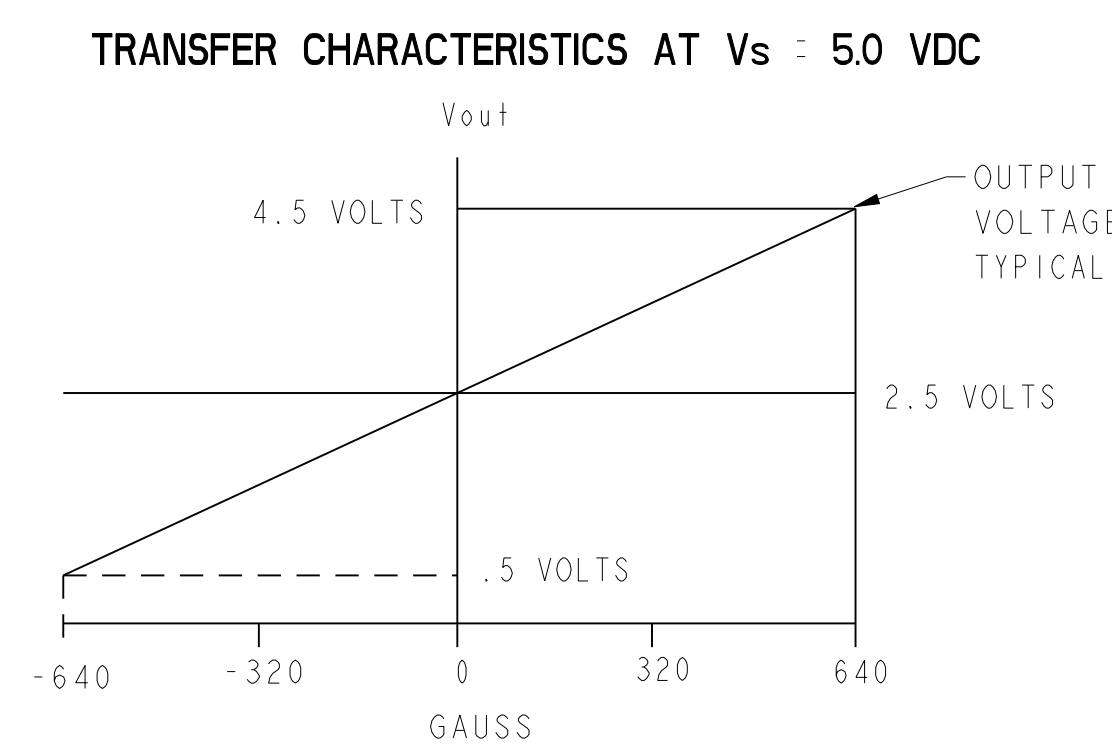
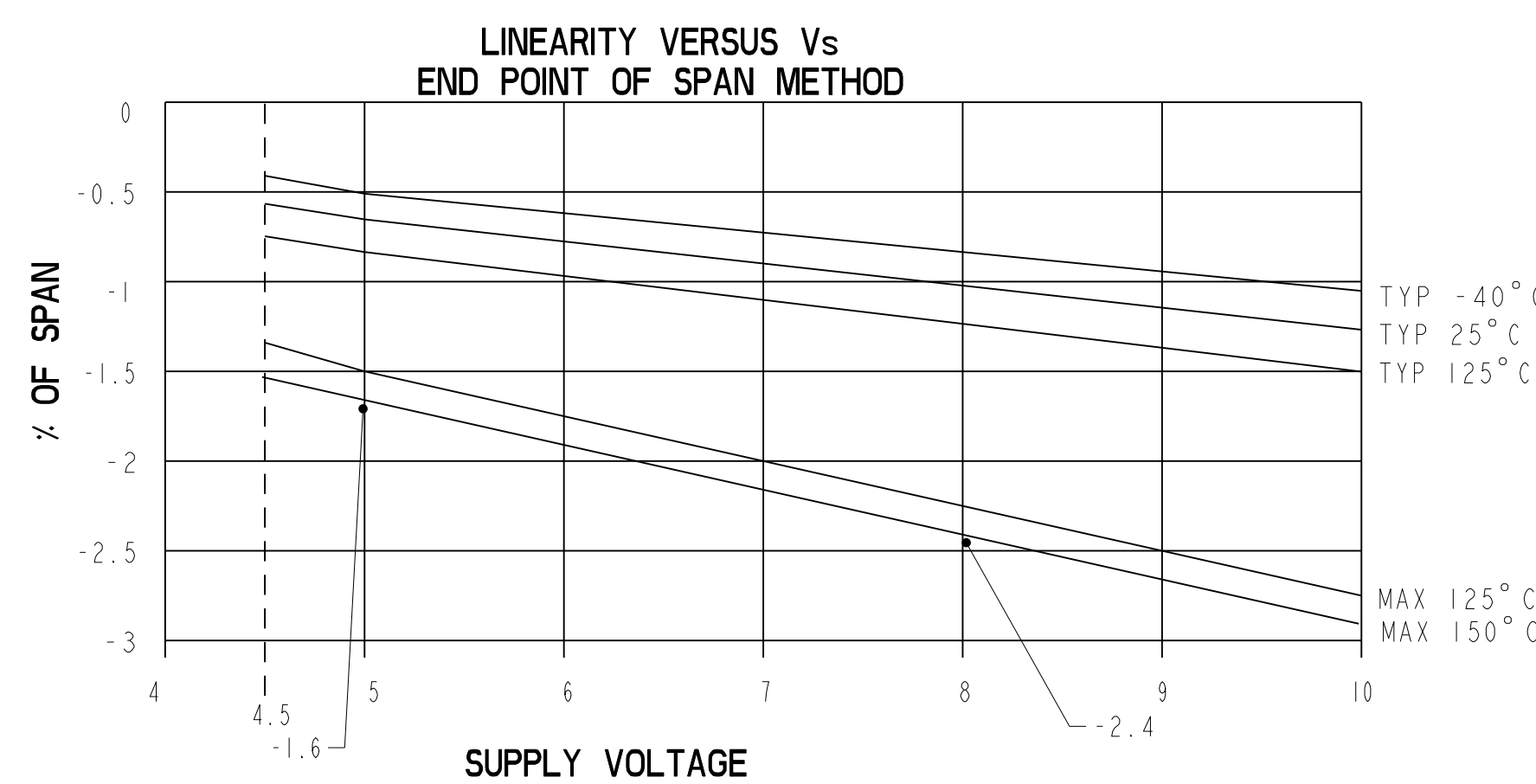
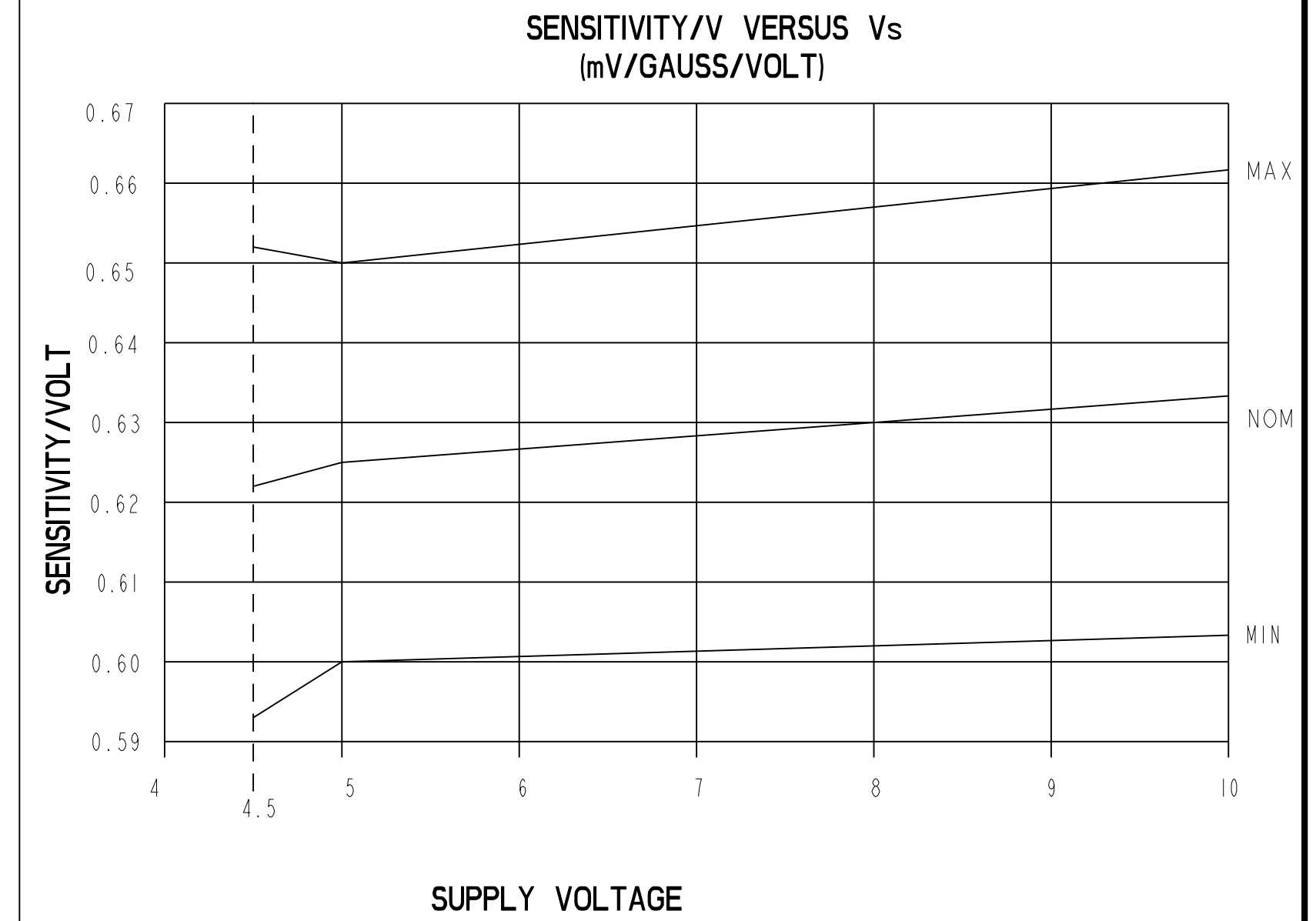
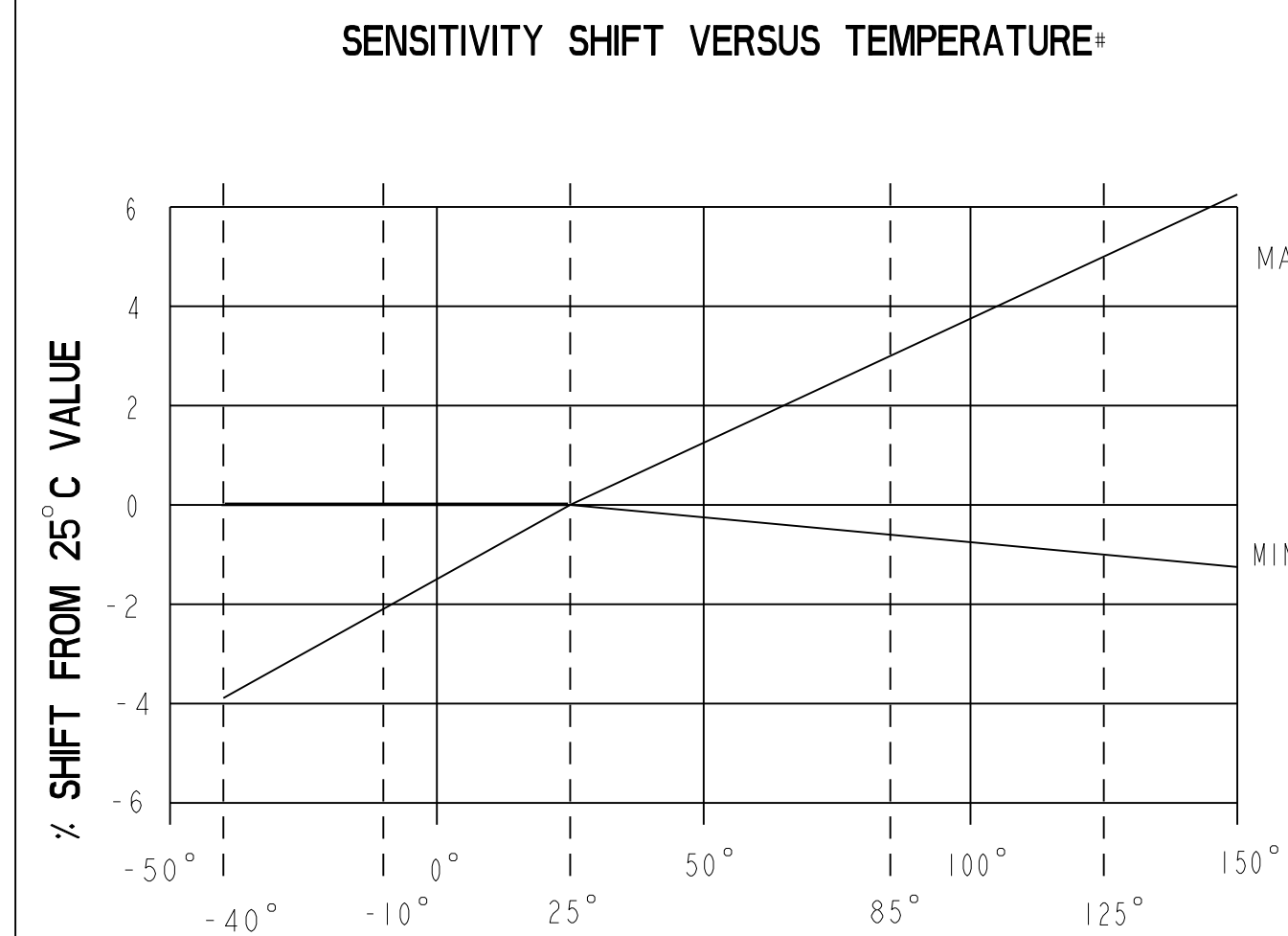
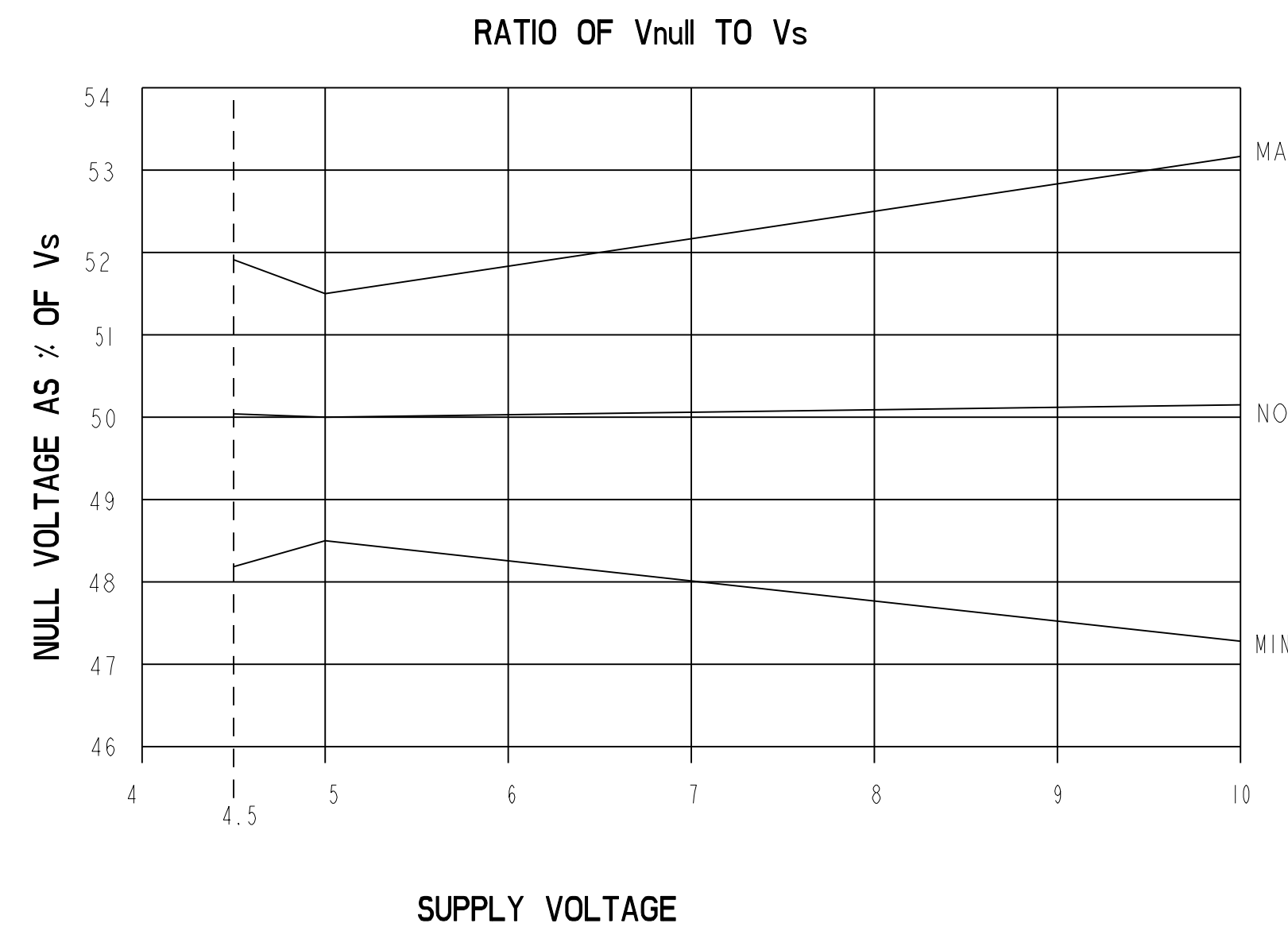
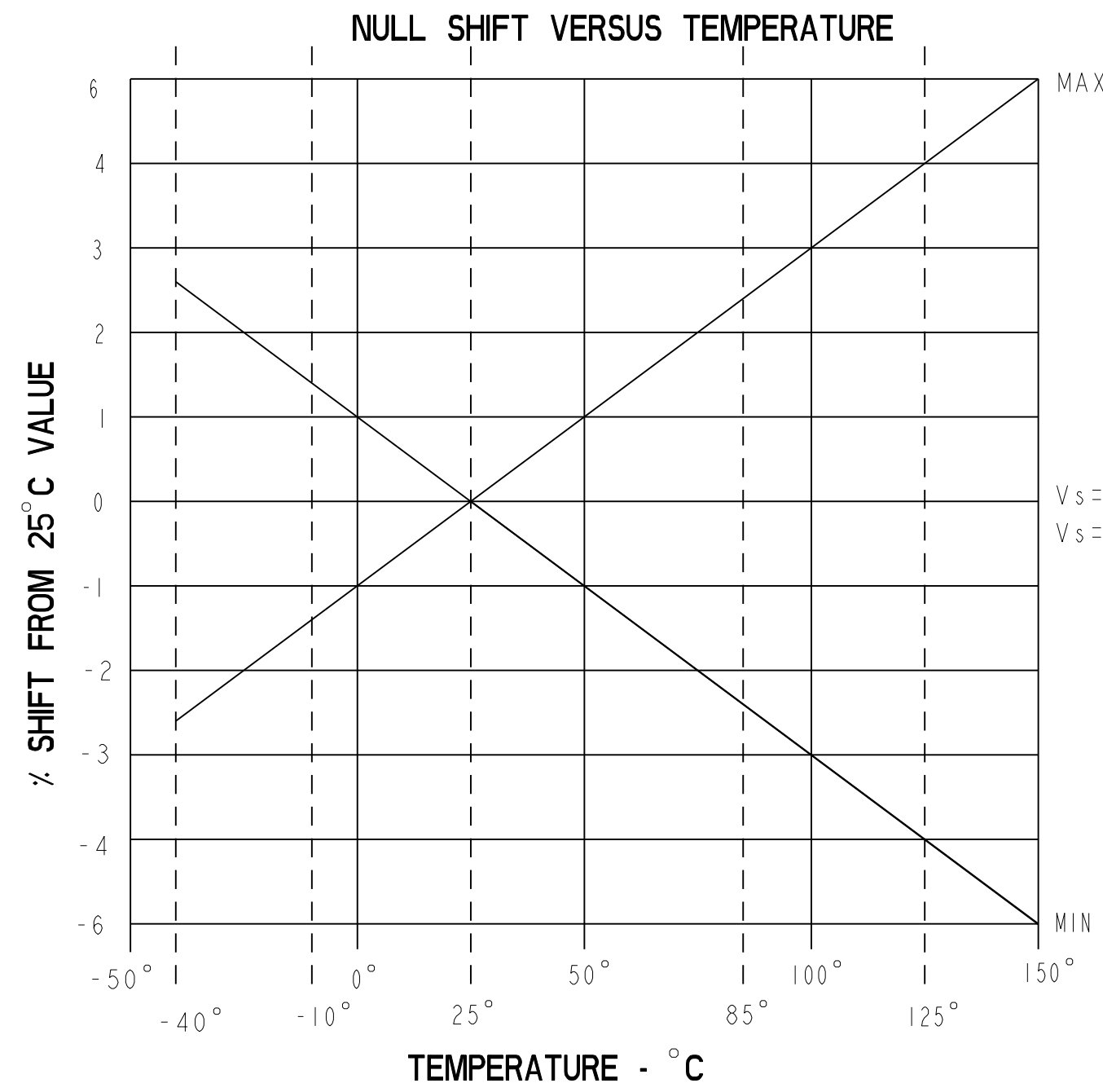

THIS DRAWING COVERS A PROPRIETARY ITEM AND IS THE PROPERTY OF MICRO SWITCH, A DIVISION OF HONEYWELL. THIS DRAWING IS NOT TO BE COPIED OR USED WITHOUT THE APPROVAL OF MICRO SWITCH.  
 FED. MFG. CODE 91929  
**MICRO SWITCH**  
 a Honeywell Division  
**MINIATURE RATIO-METRIC LINEAR HALL EFFECT SENSOR**  
 SS495 SERIES CHART 1  
 CATALOG LISTING

THIRD ANGLE PROJECTION	
SCALE	NONE
DO NOT SCALE PRINT	
UNLESS OTHERWISE SPECIFIED TOLERANCES ARE	
ONE PLACE	(.0) +.030
TWO PLACE	(.00) +.015
THREE PLACE	(.000) +.005
ANGLES	+2°
WEIGHT	

ANSI Y14.5M-1982 APPLIES

CHARACTERISTICS ARE AT  $V_s=5.00$  WITH 4.7K OUTPUT TO MINUS WITH  $T_A: -40^\circ\text{C}$  TO  $+125^\circ\text{C}$  UNLESS OTHERWISE SPECIFIED

SS495A2

SS495 SERIES CHART 1

PARAMETER	CONDITIONS	MIN	TYP	MAX	UNITS
SENSITIVITY	$T_A = 25^\circ\text{C}$	2.969	3.125	3.281	mV/GAUSS
NULL	$T_A = 25^\circ\text{C}$	2.400	2.50	2.600	VOLTS
SUPPLY CURRENT	$T_A = 25^\circ\text{C}$		7	8.7	mA
OUTPUT CURRENT SOURCE	$V_s > 4.5$	1mA	1.5mA		
SINK	$V_s > 4.5$	.6mA	1.5mA		
SINK	$V_s > 5.0$	1mA	1.5mA		
RESPONSE TIME			3 $\mu\text{s}$		
OUTPUT VOLTAGE SWING					
VOM -	-B APPLIED	.4	.2		VOLTS
VOM +	+B APPLIED	$V_s - .4$	$V_s - .2$		VOLTS
B LIMITS FOR LINEAR OPERATION					
-B MAX		-600	-670		GAUSS
+B MAX		+600	+670		GAUSS
$V_{null}$ DRIFT	$B = 0, T_A = 25^\circ\text{C}$ TO $125^\circ\text{C}$	-.07		+.07	% / $^\circ\text{C}$
$V_{null}$ DRIFT	$B = 0, T_A = +125^\circ\text{C}$ TO $+150^\circ\text{C}$	-.08		+.08	% / $^\circ\text{C}$
SENSITIVITY DRIFT	$T_A = +25^\circ\text{C}$ TO $+150^\circ\text{C}$	-.02		+.06	% / $^\circ\text{C}$
SENSITIVITY DRIFT	$T_A = -40^\circ\text{C}$ TO $+25^\circ\text{C}$	-.01		+.07	% / $^\circ\text{C}$
LINEARITY	$B = -600$ TO $+600$	0	-1.0	-1.5	% OF SPAN
SUPPLY VOLTAGE	$-40^\circ\text{C}$ TO $+125^\circ\text{C}$	4.5	5.0	10.5	VOLTS
OPERATING TEMP	SEE MAX TEMPERATURE CHART	-40		+150	$^\circ\text{C}$

BLOCK DIAGRAM CURRENT SINKING OR SOURCING OUTPUT

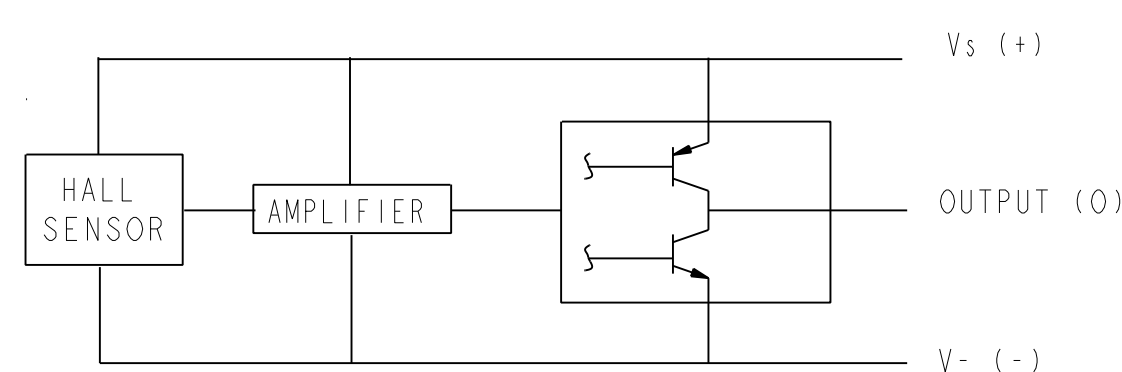

ABSOLUTE MAXIMUM CHARACTERISTICS

CHARACTERISTIC	SYMBOL	TEST CONDITION	MIN	MAX	UNITS
SUPPLY VOLTAGE	$V_{cc}$		-0.5	11	V
OUTPUT VOLTAGE	$V_{out}$		-0.5	11	V
OUTPUT CURRENT	$I_{out}$	SOURCE OR SINK	10		mA
TEMPERATURE	$T_A$	OPERATING	-55	150	$^\circ\text{C}$
	$T_s$	STORAGE ( $V_{cc}=0$ )	-55	165	$^\circ\text{C}$

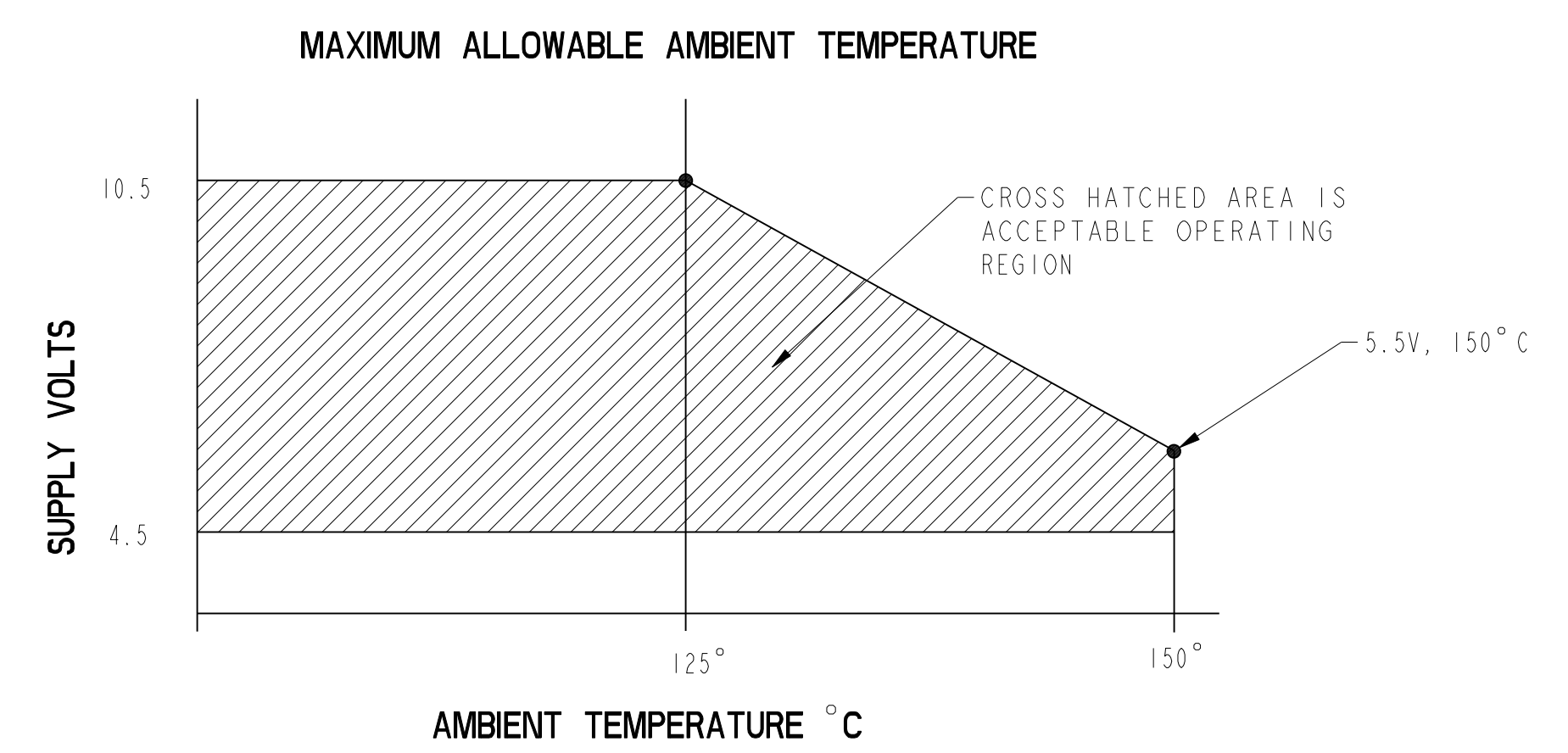
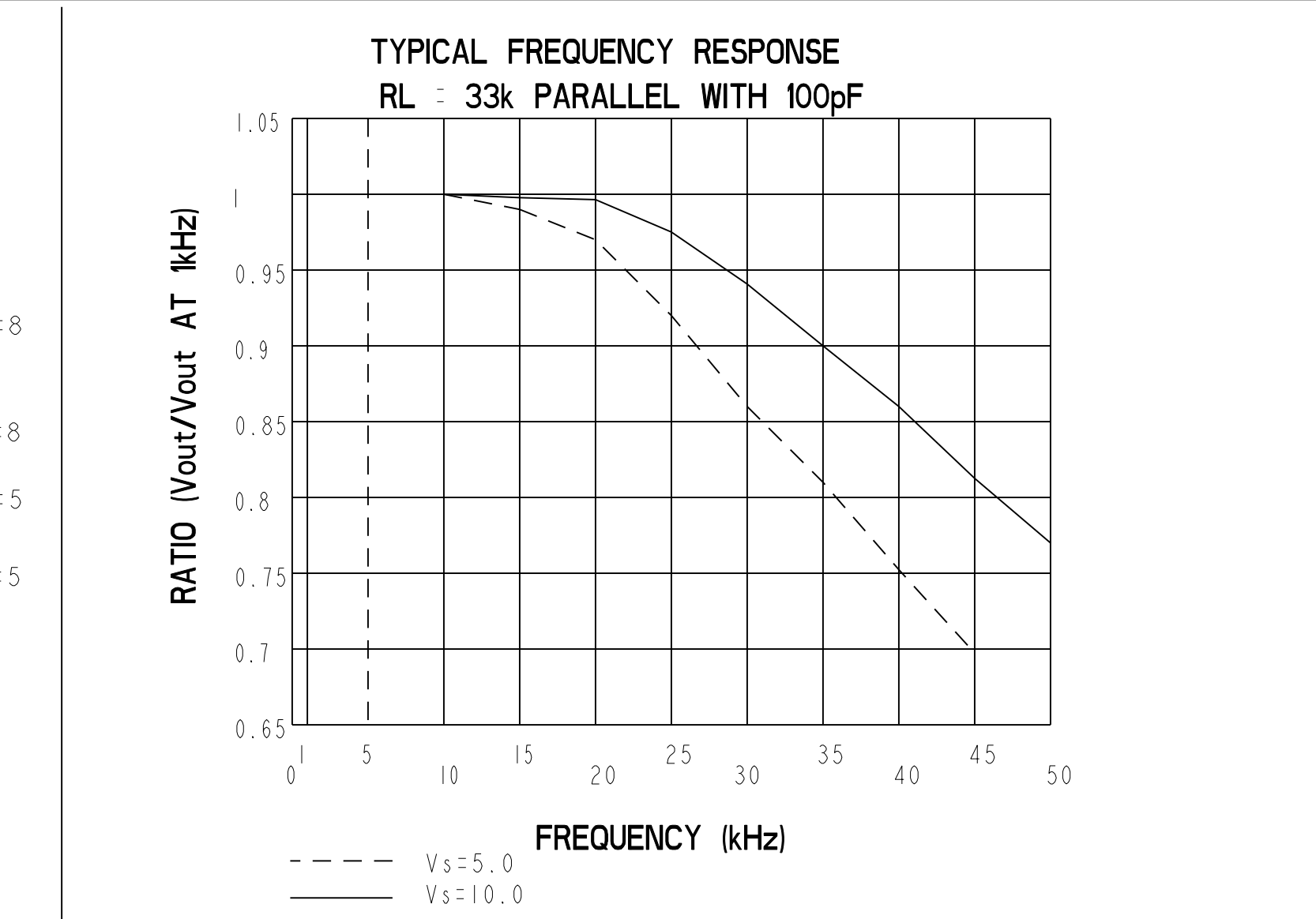
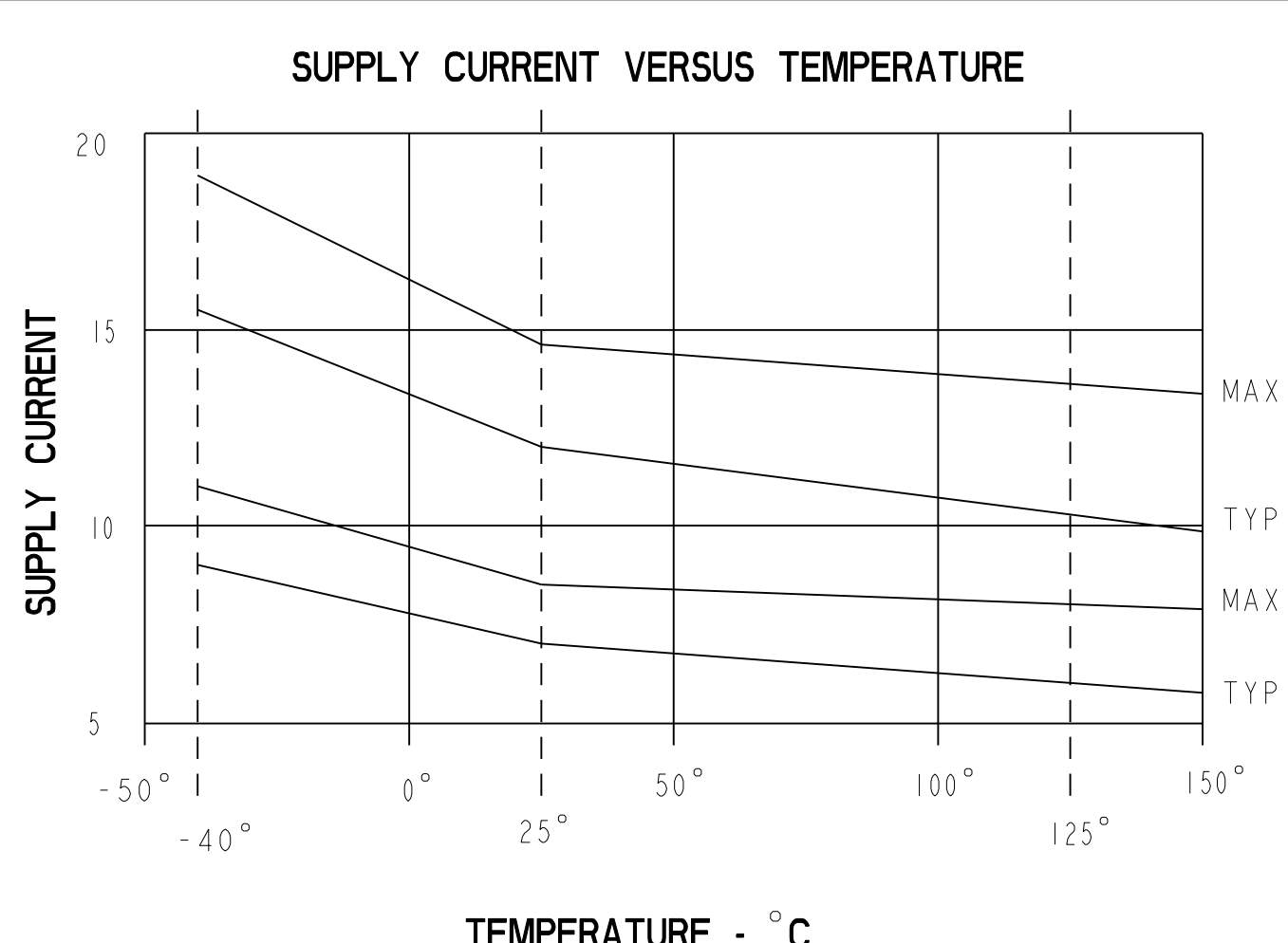
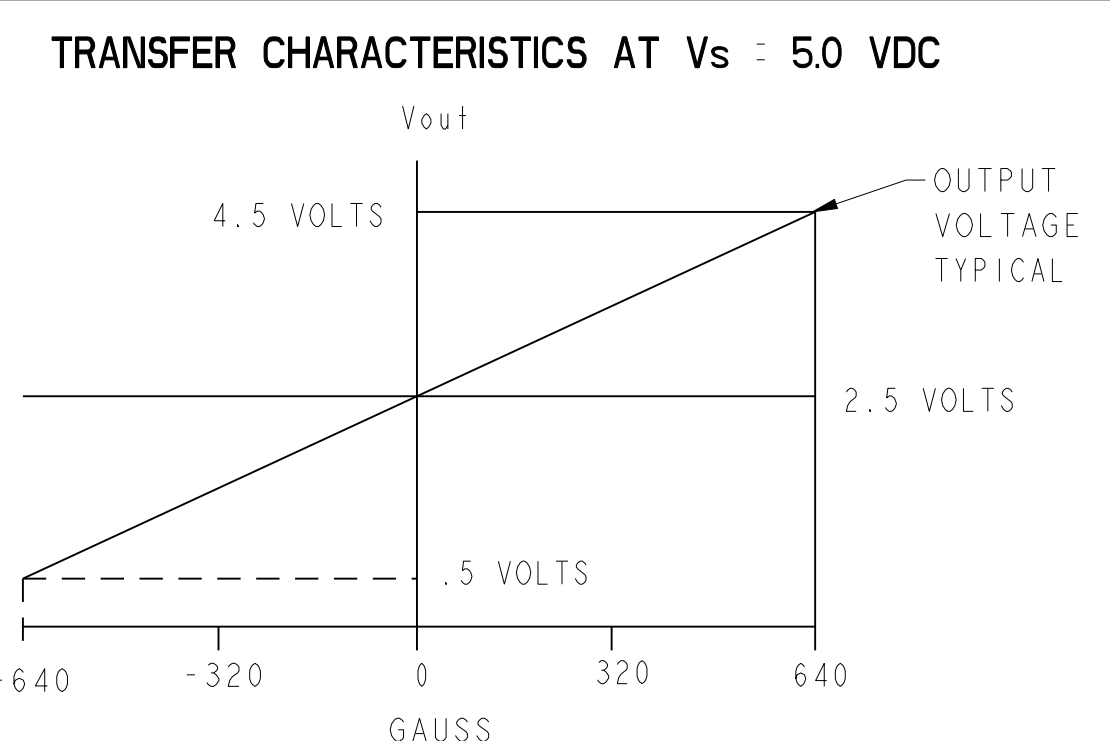
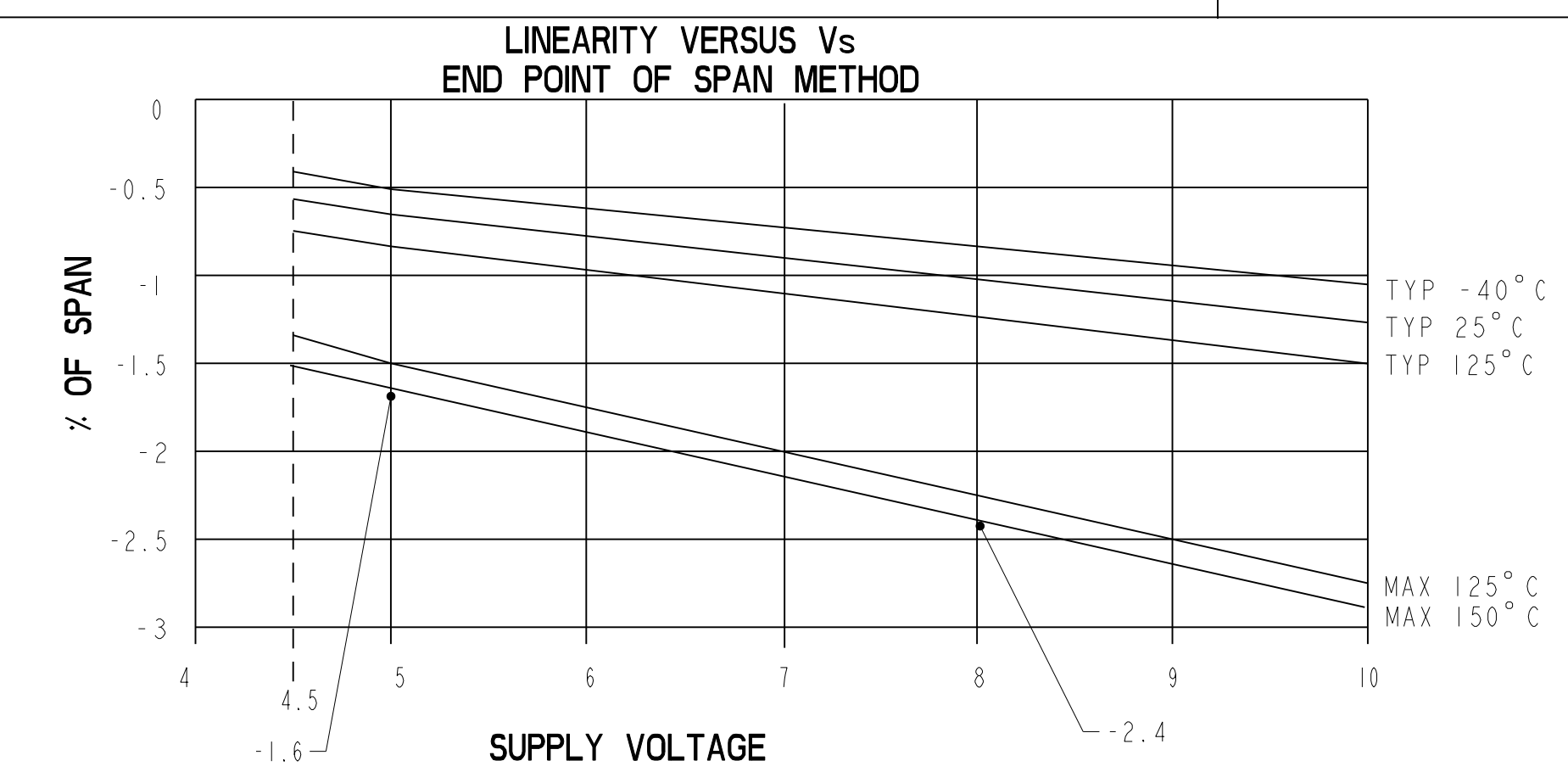
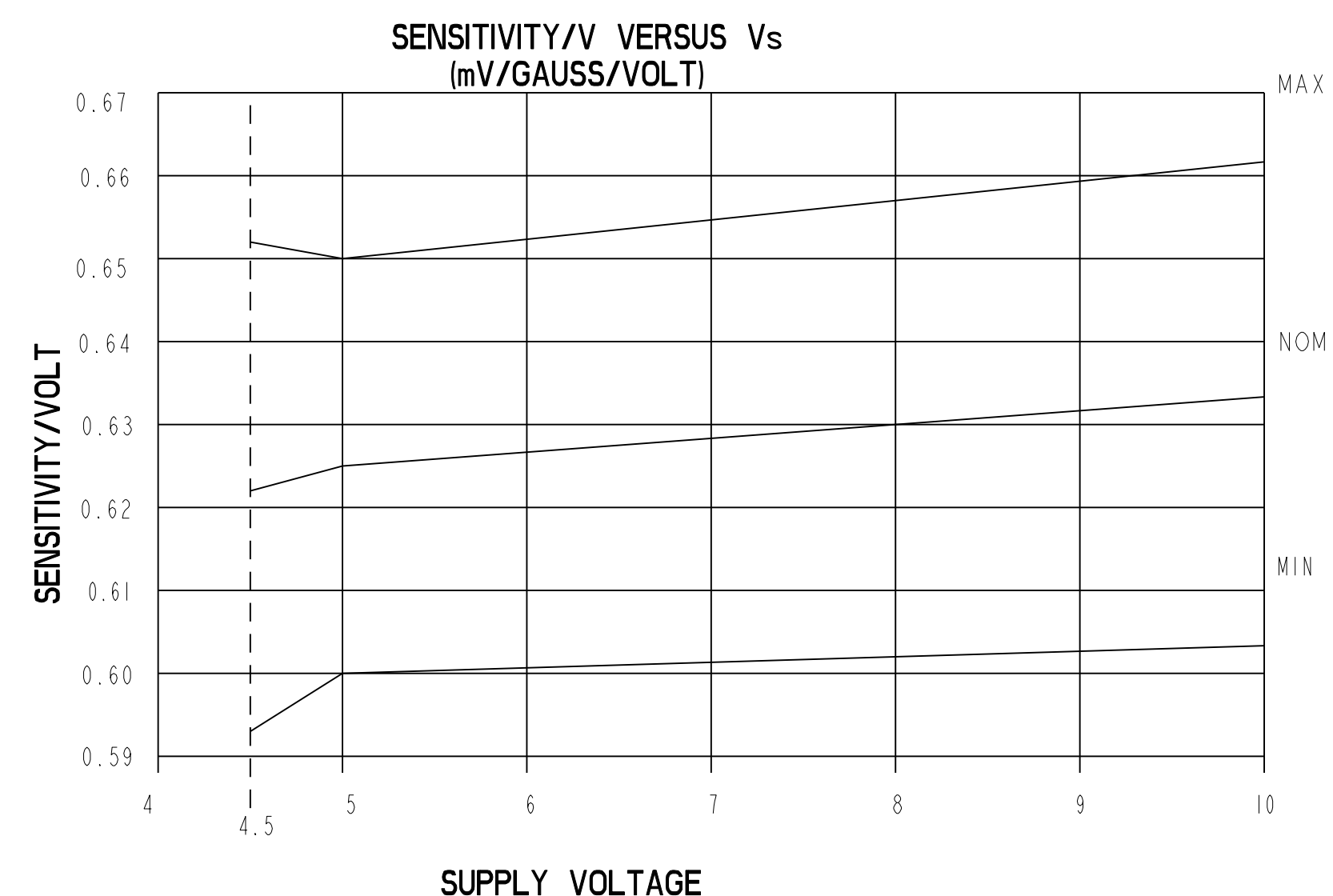
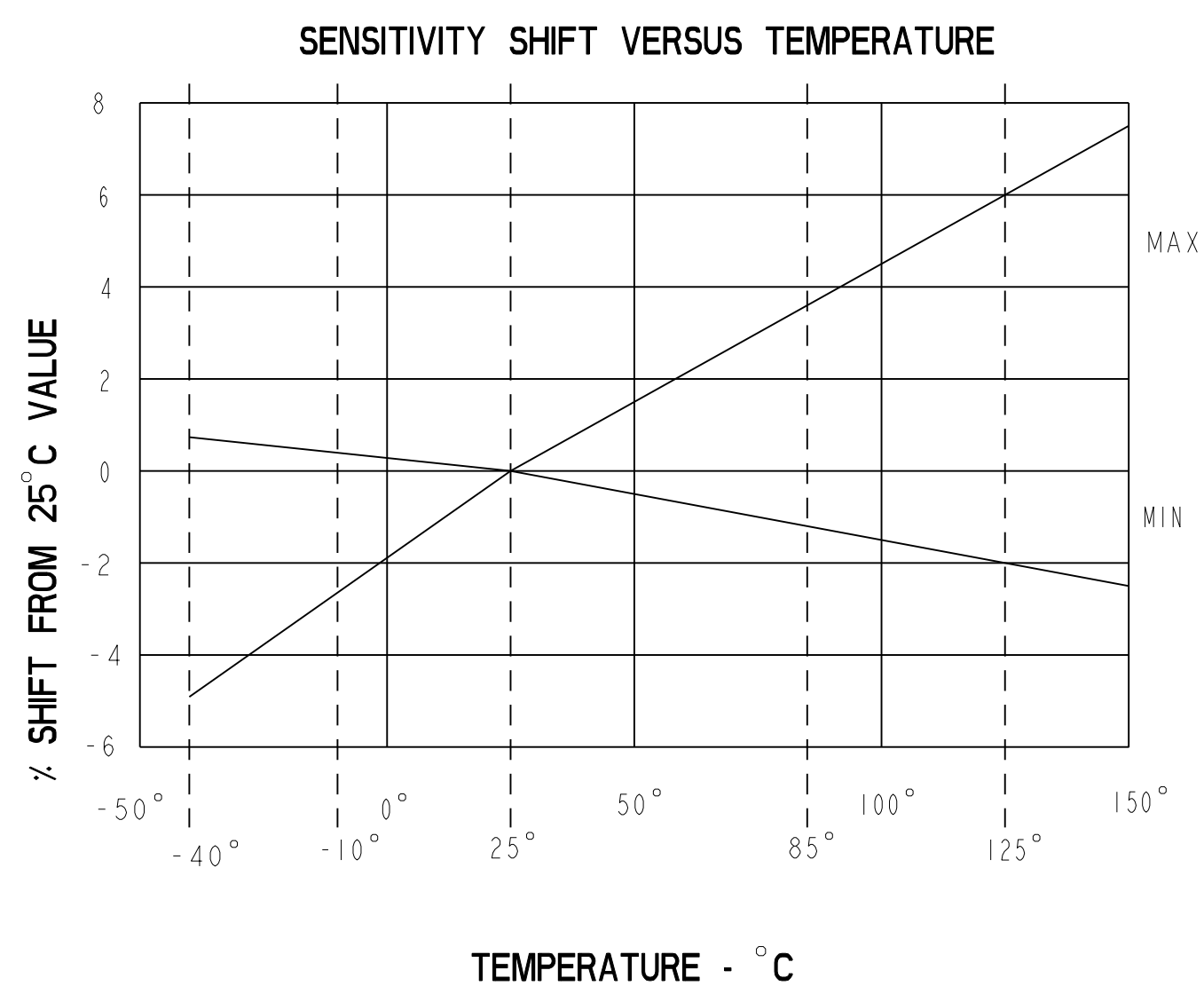
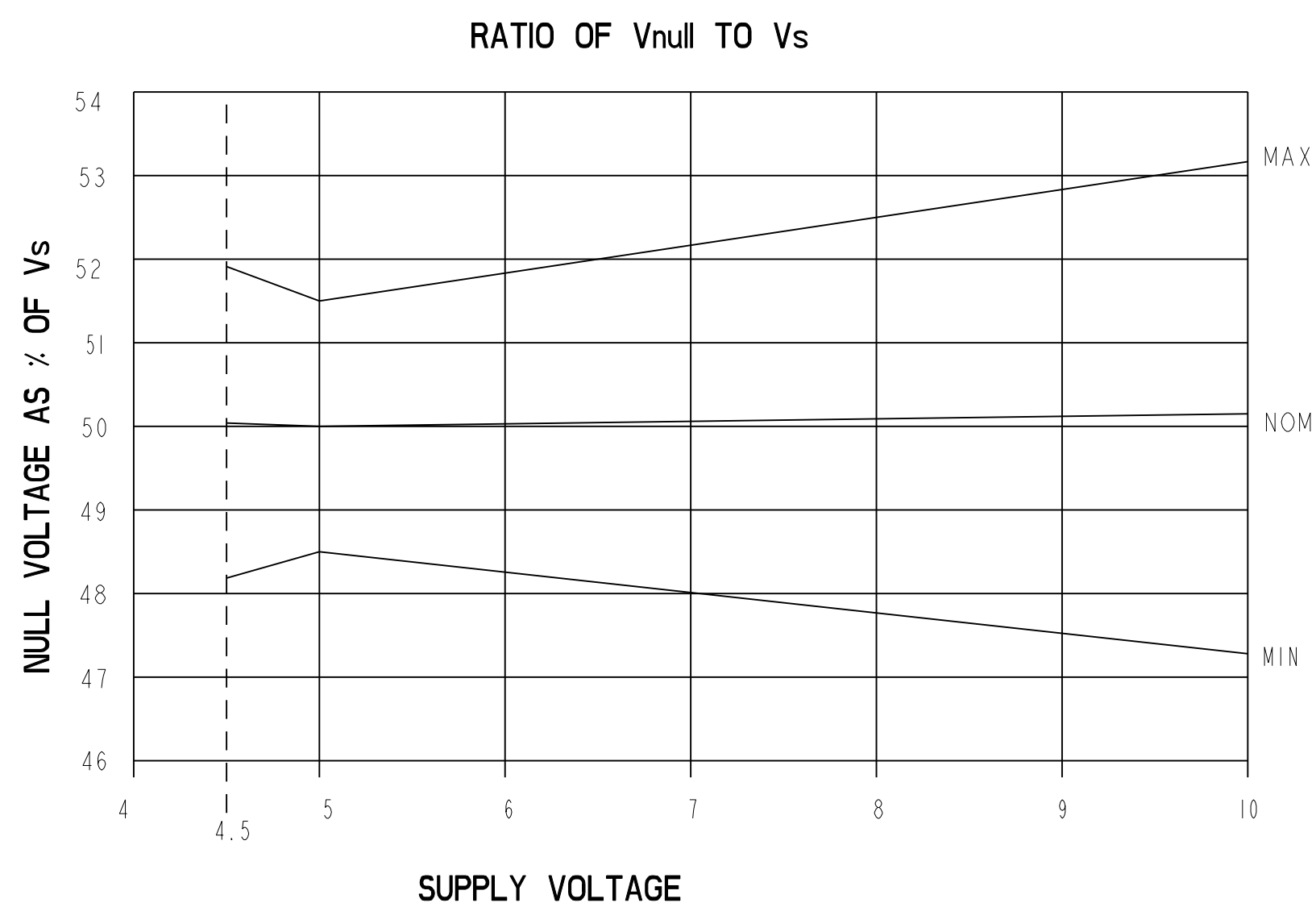
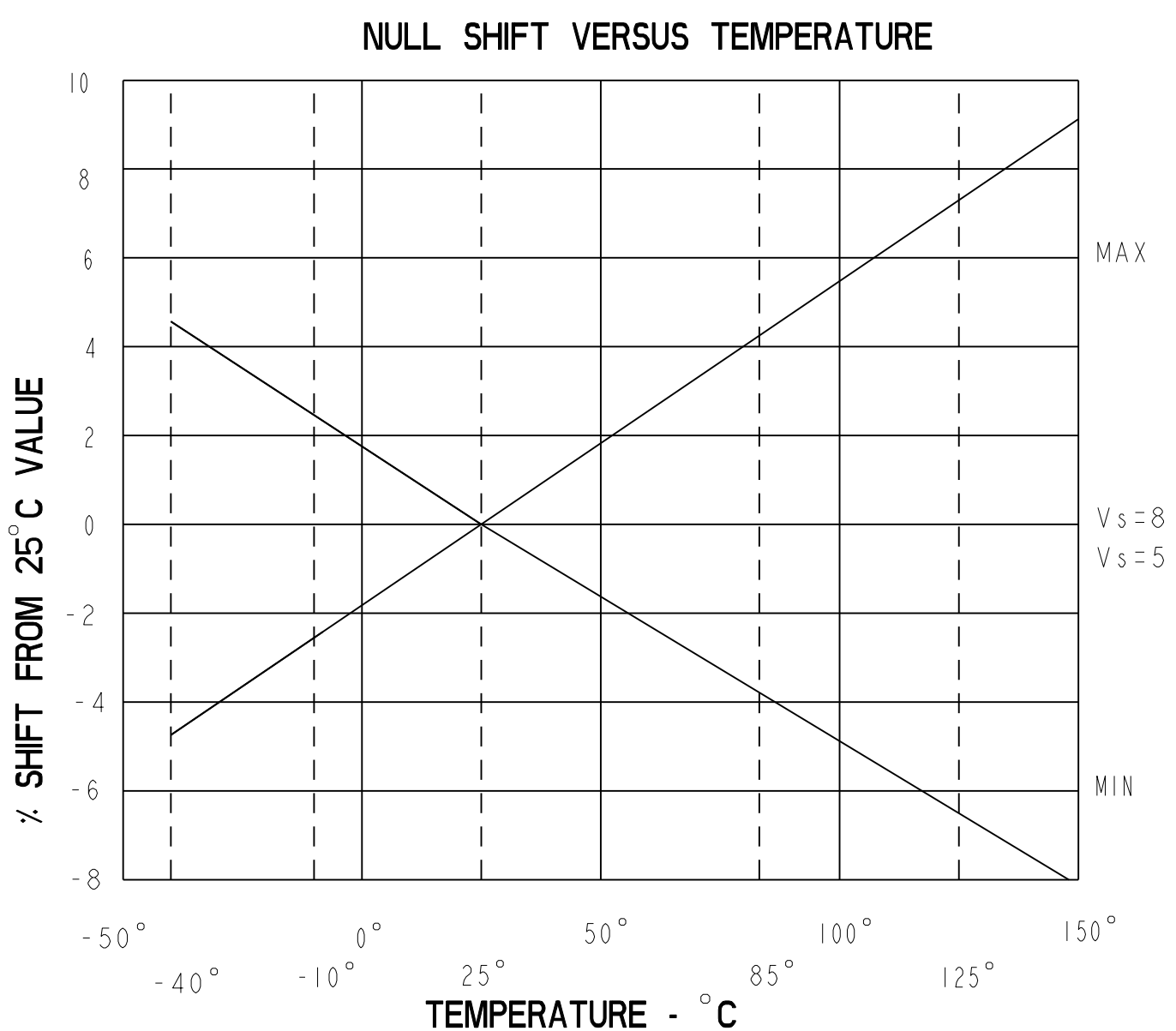

THIS DRAWING COVERS A PROPRIETARY ITEM AND IS THE PROPERTY OF MICRO SWITCH, A DIVISION OF HONEYWELL. THIS DRAWING IS NOT TO BE COPIED OR USED WITHOUT THE APPROVAL OF MICRO SWITCH.

FED. MFG. CODE 91929

**MICRO SWITCH**  
a Honeywell Division

**MINIATURE RATIO-METRIC LINEAR HALL EFFECT SENSOR**

SS495 SERIES CHART 1

CATALOG LISTING

ONE PLACE	(.0)	+ .030
TWO PLACE	(.00)	+ .015
THREE PLACE	(.000)	+ .005
ANGLES		+ 2°
WEIGHT		

THIRD ANGLE PROJECTION

SCALE NONE

DO NOT SCALE PRINT

UNLESS OTHERWISE SPECIFIED TOLERANCES ARE

PTC/CAD 2D  
 DRAWN: C.S.L.  
 CHECK: S.A.V.  
 DATE: 15 APR 02  
 RELEASE NO. PR-22532  
 REVISIONS:  
 14  
 ISSUE: 14  
 DRAWING NUMBER: 4 OF 5  
 SS495 SERIES CHART 1  
 26 OCT 01

CHARACTERISTICS ARE AT  $V_s=5.00$  WITH 4.7K OUTPUT TO MINUS WITH  $T_A: -40^\circ\text{C}$  TO  $+125^\circ\text{C}$  UNLESS OTHERWISE SPECIFIED

SS495B

SS495 SERIES CHART 1

PARAMETER	CONDITIONS	MIN	TYP	MAX	UNITS
SENSITIVITY	$T_A = 25^\circ\text{C}$	2.875	3.125	3.375	mV/GAUSS
NULL	$T_A = 25^\circ\text{C}$	2.35	2.50	2.650	VOLTS
SUPPLY CURRENT	$T_A = 25^\circ\text{C}$		7	8.7	mA
OUTPUT CURRENT SOURCE	$V_s > 4.5$	1mA	1.5mA		
SINK	$V_s > 4.5$		.6mA	1.5mA	
SINK	$V_s > 5.0$	1mA	1.5mA		
RESPONSE TIME			3μS		
OUTPUT VOLTAGE SWING					
VOM -	-B APPLIED	.4	.2		VOLTS
VOM +	+B APPLIED	$V_s - .4$	$V_s - .2$		VOLTS
B LIMITS FOR LINEAR OPERATION					GAUSS
-B MAX		-600	-670		
+B MAX		+600	+670		
$V_{null}$ DRIFT	$B = 0, T_A = 25^\circ\text{C}$ TO $125^\circ\text{C}$	-.08		+.08	% / °C
$V_{null}$ DRIFT	$B = 0, T_A = +125^\circ\text{C}$ TO $+150^\circ\text{C}$	-.08		+.08	% / °C
SENSITIVITY DRIFT	$T_A = +25^\circ\text{C}$ TO $+150^\circ\text{C}$	-.02		+.08	% / °C
SENSITIVITY DRIFT	$T_A = -40^\circ\text{C}$ TO $+25^\circ\text{C}$	-.02		+.08	% / °C
LINEARITY	$B = -600$ TO $+600$	0	-1.0	-1.5	% OF SPAN
SUPPLY VOLTAGE	$-40^\circ\text{C}$ TO $+125^\circ\text{C}$	4.5	5.0	10.5	VOLTS
OPERATING TEMP	SEE MAX TEMPERATURE CHART	-40		+150	°C

BLOCK DIAGRAM CURRENT SINKING OR SOURCING OUTPUT

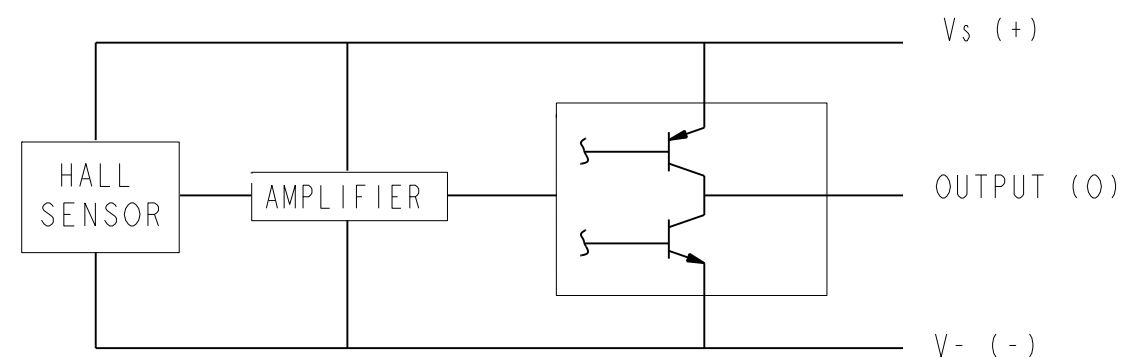

ABSOLUTE MAXIMUM CHARACTERISTICS

CHARACTERISTIC	SYMBOL	TEST CONDITION	MIN	MAX	UNITS
SUPPLY VOLTAGE	$V_{cc}$		-0.5	11	V
OUTPUT VOLTAGE	$V_{out}$		-0.5	11	V
OUTPUT CURRENT	$I_{out}$	SOURCE OR SINK	10		mA
TEMPERATURE	$T_A$	OPERATING	-55	150	°C
	$T_s$	STORAGE ( $V_{cc}=0$ )	-55	165	°C

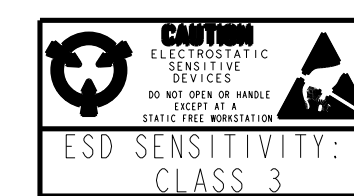
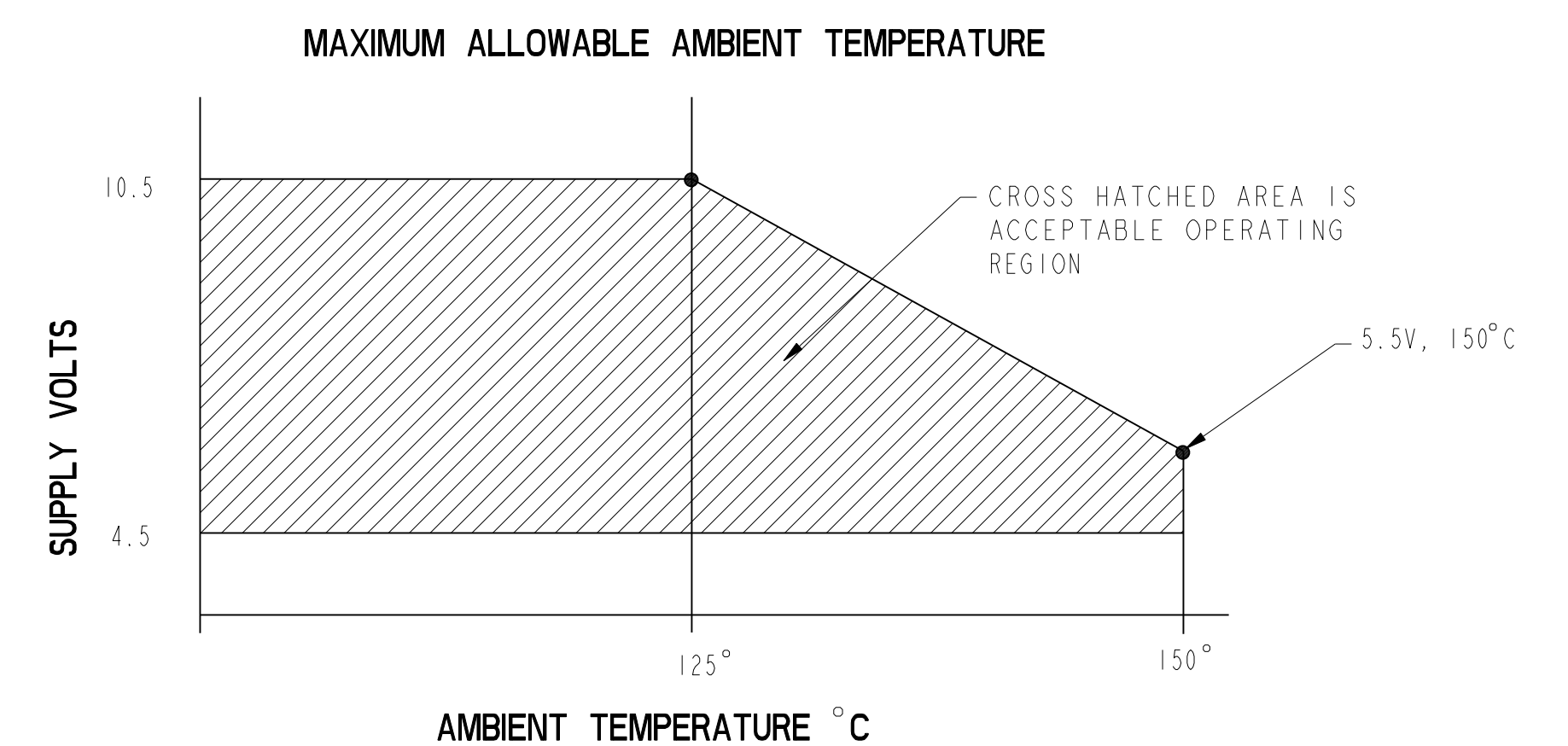
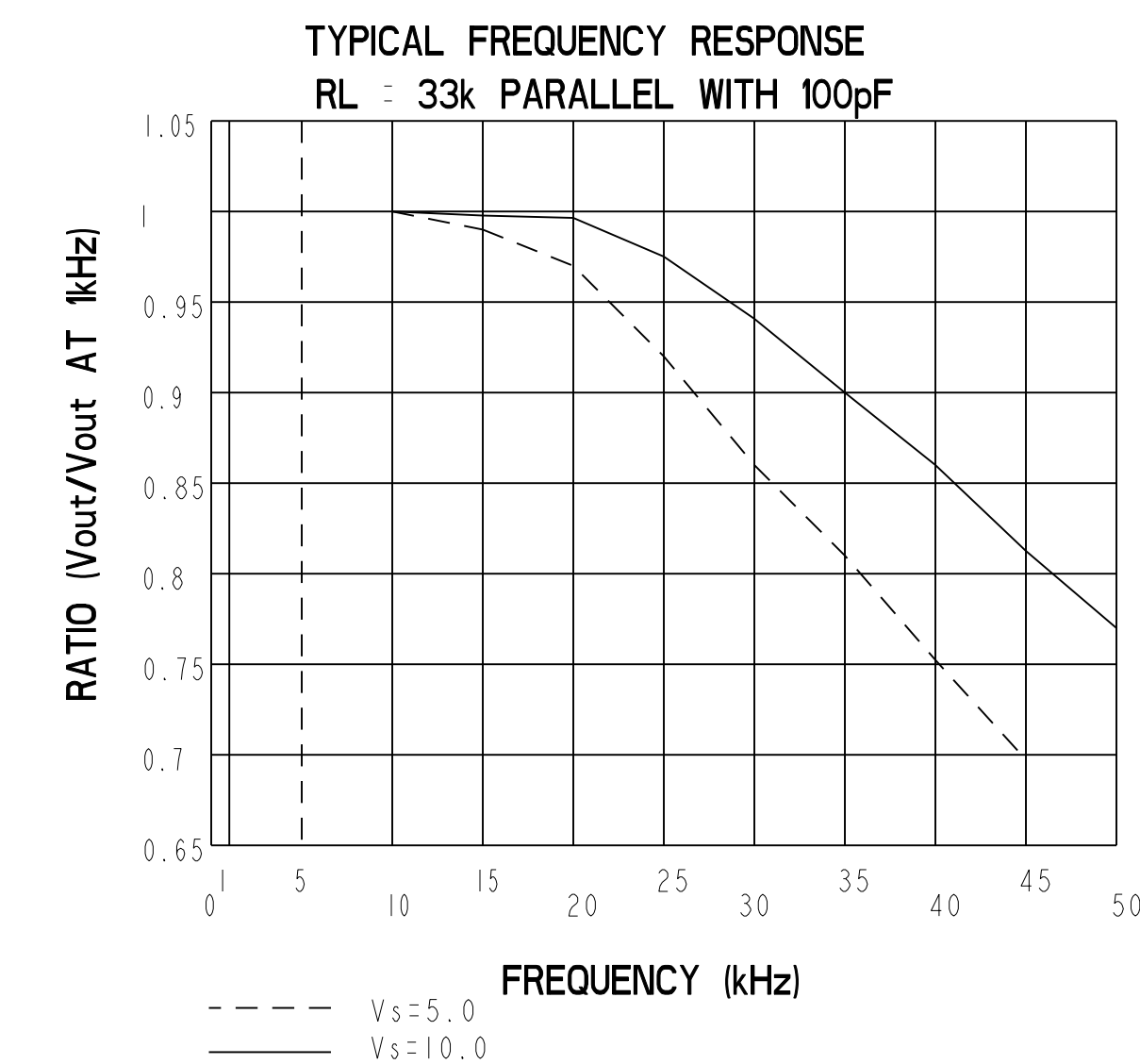
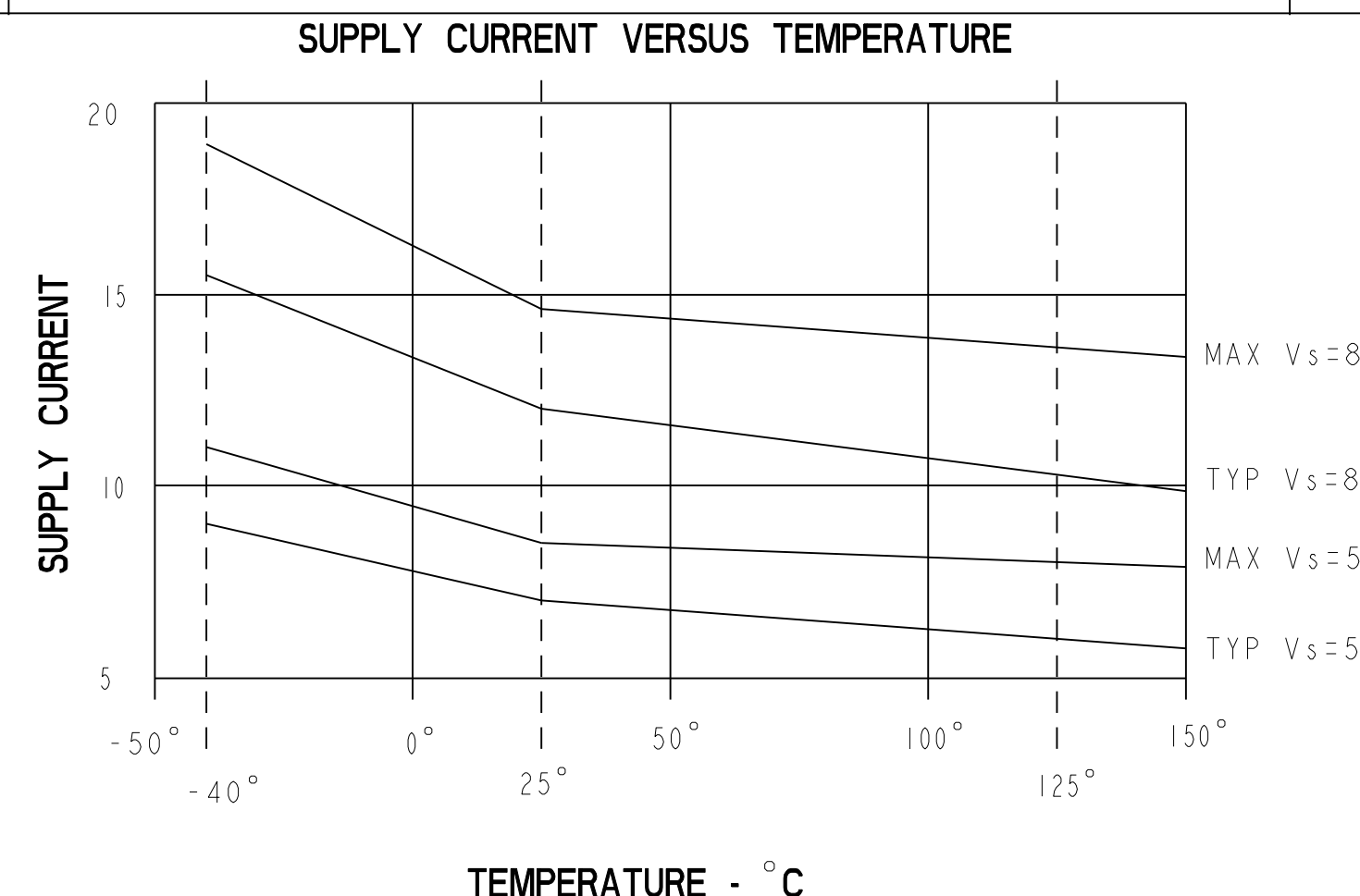
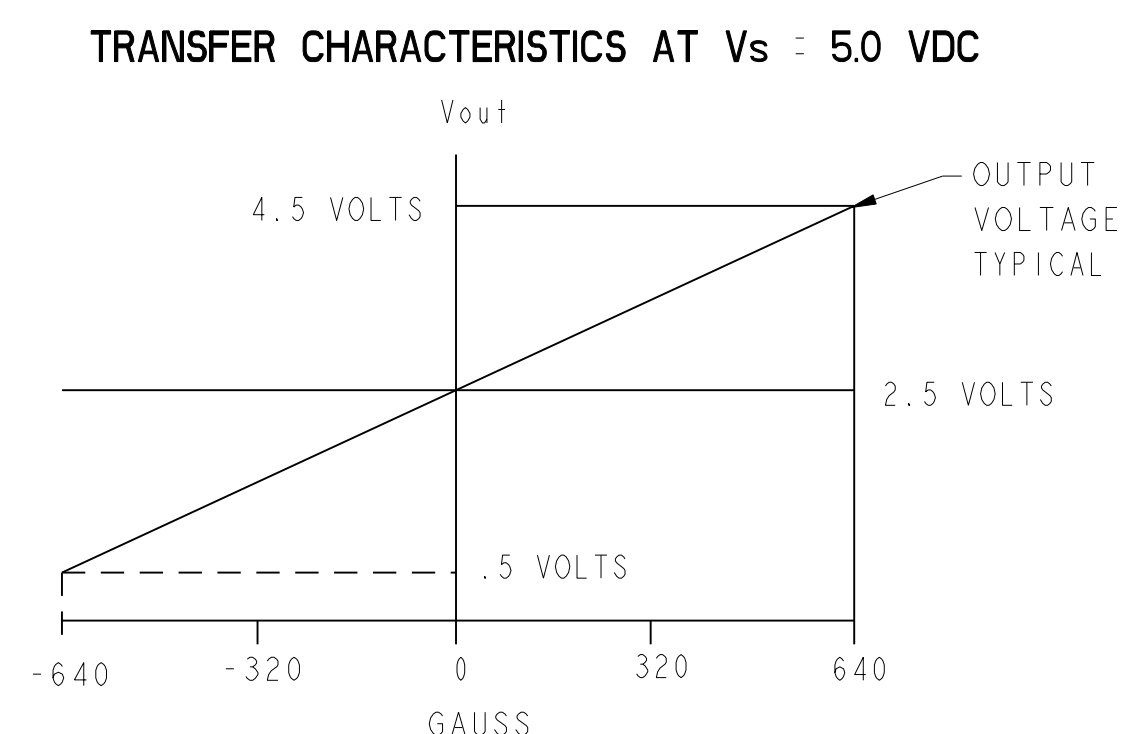
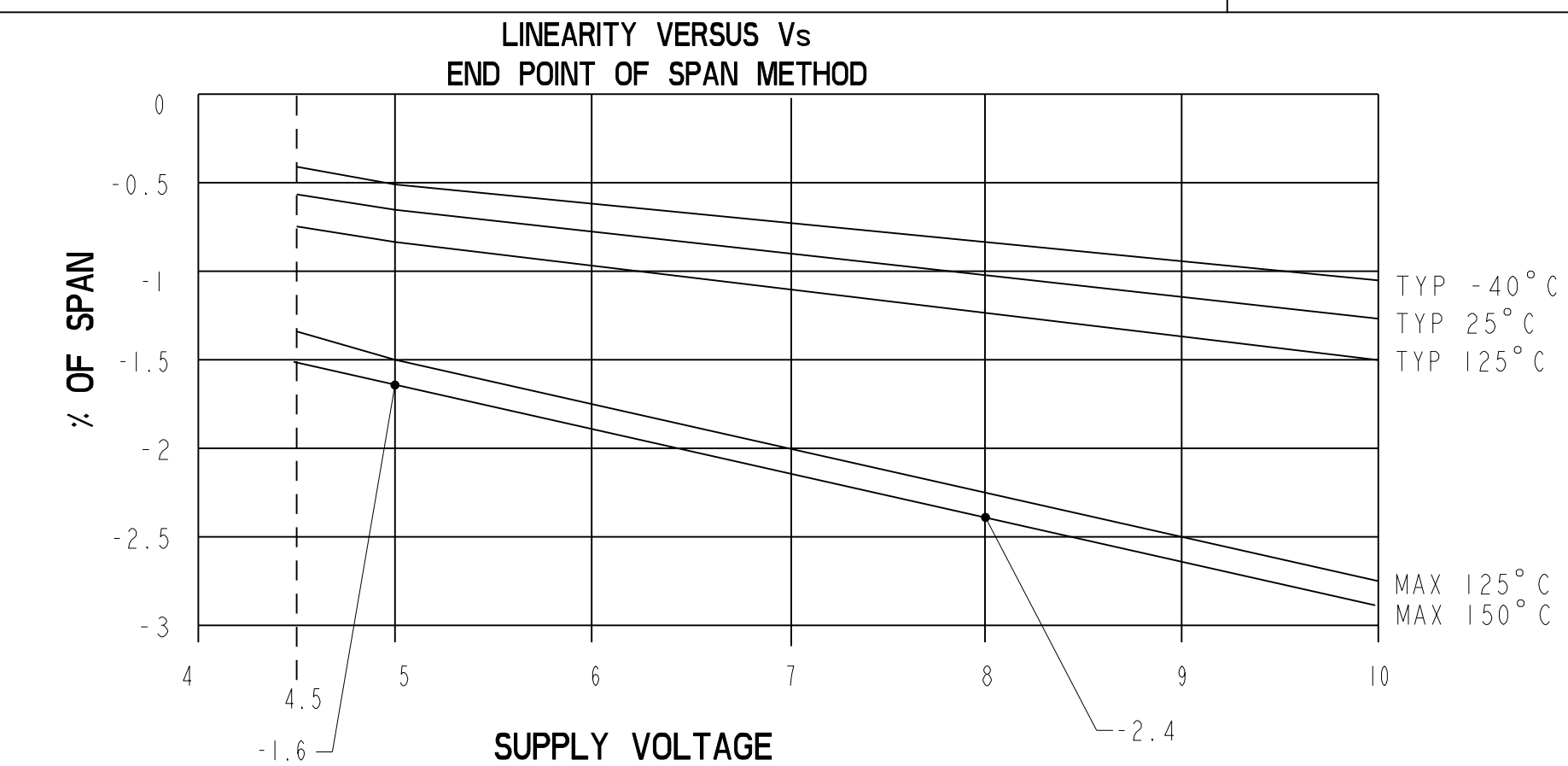
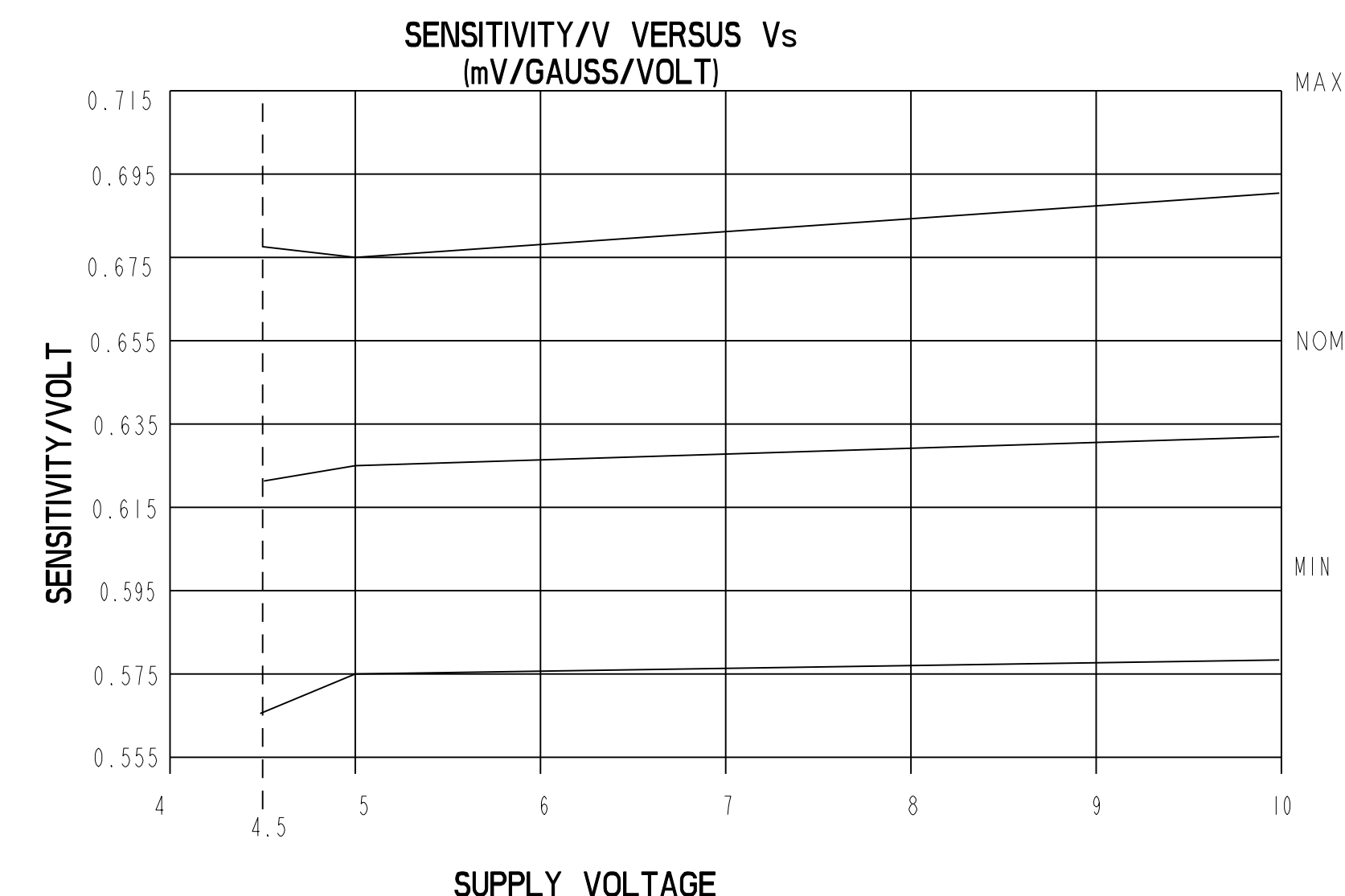
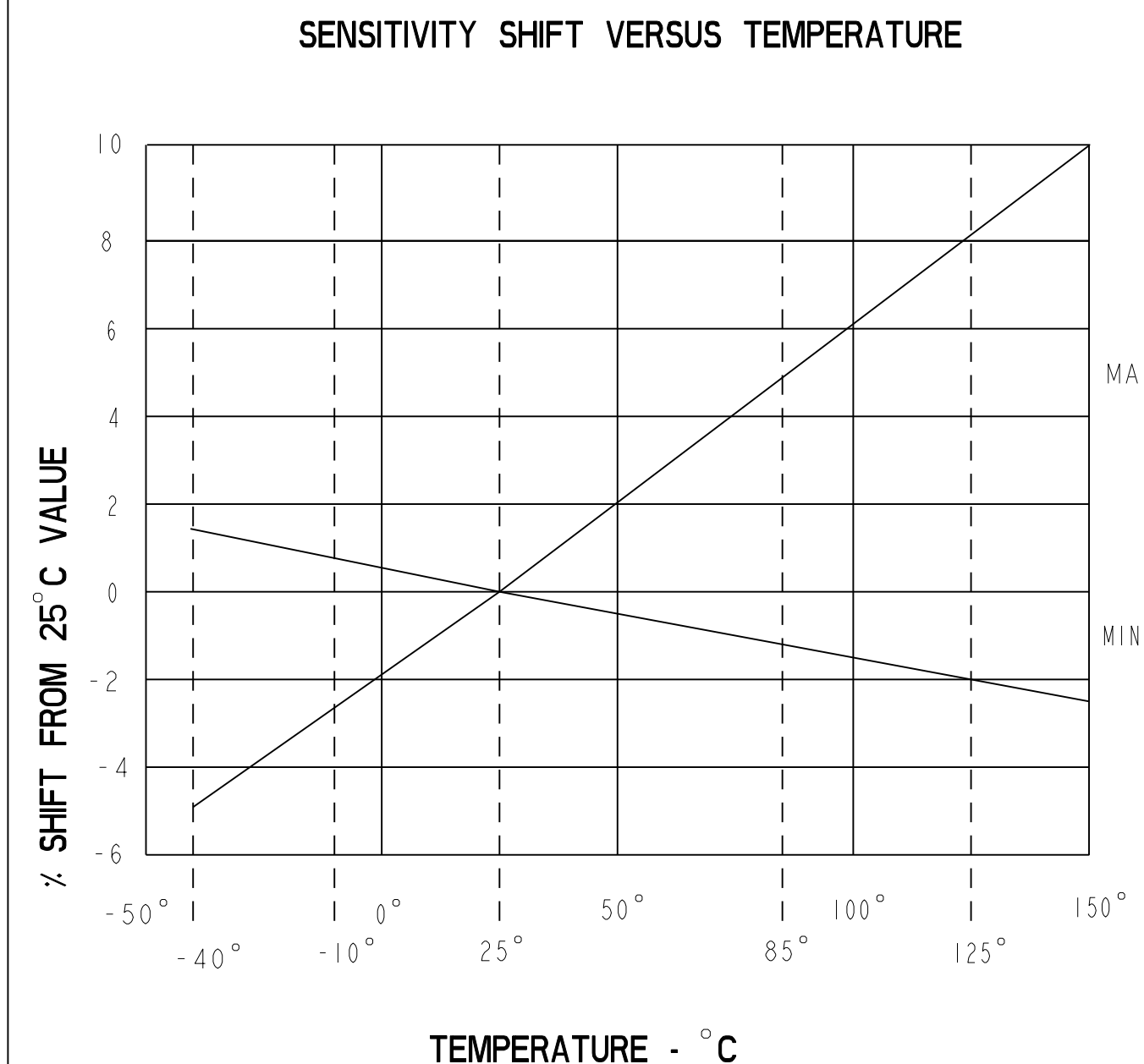
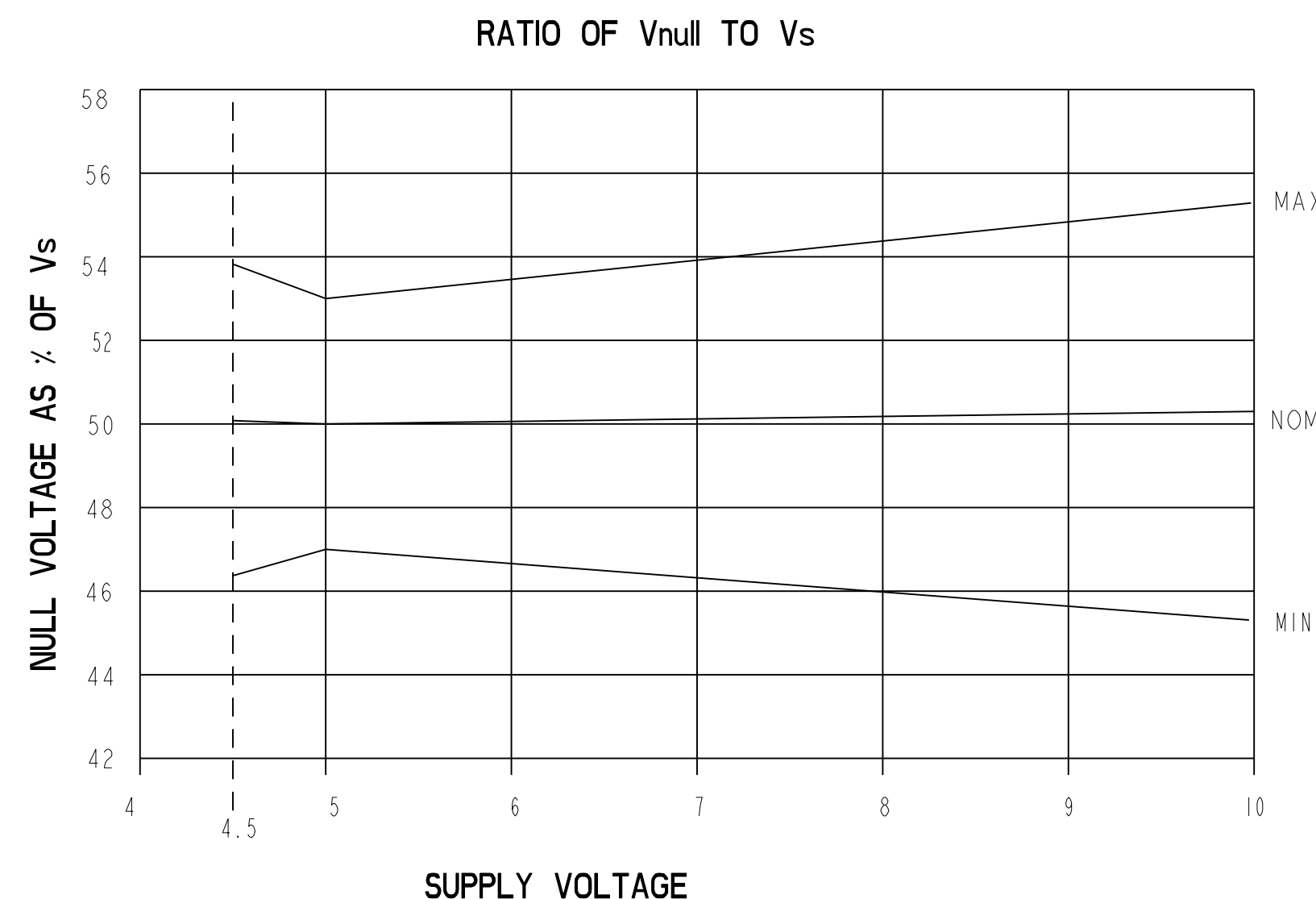
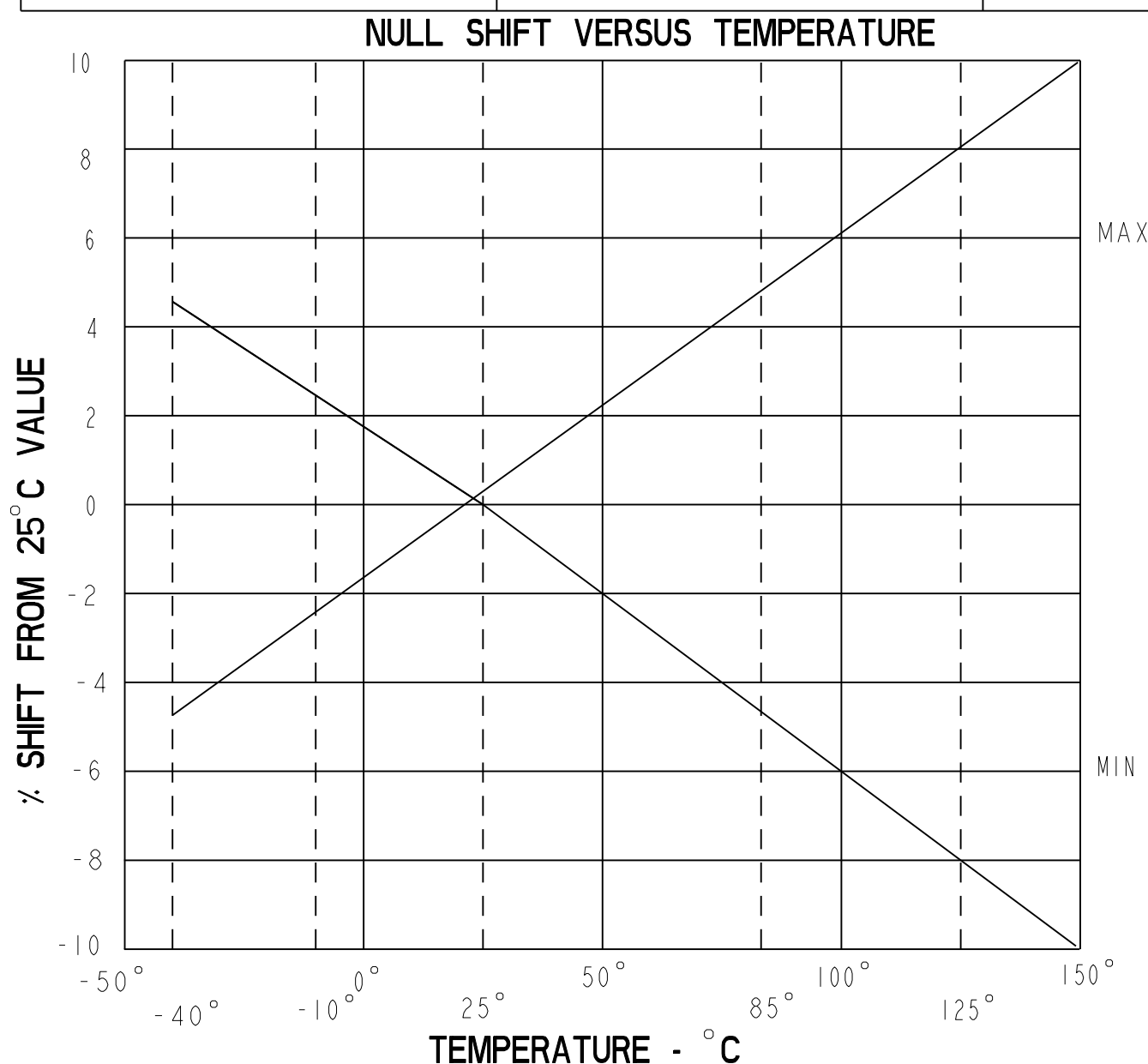

THIS DRAWING COVERS A PROPRIETARY ITEM AND IS THE PROPERTY OF MICRO SWITCH, A DIVISION OF HONEYWELL. THIS DRAWING IS NOT TO BE COPIED OR USED WITHOUT THE APPROVAL OF MICRO SWITCH.  
 FED. MFG. CODE 91929  
**MICRO SWITCH**  
 a Honeywell Division  
**MINIATURE RATIO-METRIC LINEAR HALL EFFECT SENSOR**  
**SS495 SERIES CHART 1**

THIRD ANGLE PROJECTION	
SCALE	NONE
DO NOT SCALE PRINT	
UNLESS OTHERWISE SPECIFIED TOLERANCES ARE	
ONE PLACE	(.0) +.030
TWO PLACE	(.00) +.015
THREE PLACE	(.000) +.005
ANGLES	+2°
WEIGHT	

ANSI Y14.5M-1982 APPLIES