

Compliant with European standards (reinforced insulation)
1 Form A/1 Form C 6A
Slim power relays

PF RELAYS (APF)

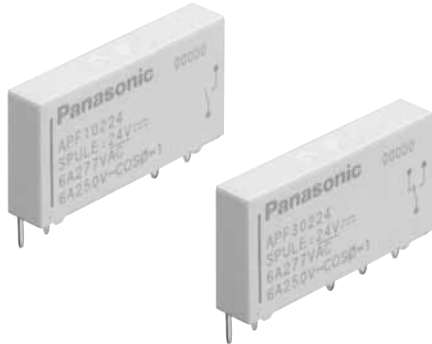

FEATURES

- High density mounting with 5 mm .197 inch width**
Space saved with 5 mm .197 inch slim type with 28 mm 1.102 inch length. Allows high density mounting and use in compact devices.
- Satisfies reinforced insulation standard (EN/IEC 61810-1).**
- High switching capacity**
Supports 6A 250 V AC nominal switching capacity (resistive load) and AC15 and DC13 (inductive load).
- 1 Form A and 1 Form C contact arrangements with options for a variety of applications.**
- 4,000 V high breakdown voltage and 6,000 V high surge breakdown voltage.**
Controller protection against surges and noise with a breakdown voltage of 4,000 Vrms for 1 min. between contacts and coil, and 6,000 V surge breakdown voltage between contacts and coil.
- Resistance to heat and fire; EN60335-1, clause 30 (GWT) approved.**
- Sealed construction allows automatic washing.**
- Complies with all safety standards.**
UL, C-UL, VDE certified.

TYPICAL APPLICATIONS

- Interface relays for programmable controllers
- Output relays for measuring equipment, timers, counters and temperature controllers
- Industrial equipment, office equipment
- Household appliances for Europe

ORDERING INFORMATION

APF 0

Contact arrangement

- 1: 1 Form A
3: 1 Form C

Contact type

- 0: Single contact

Contact material

- 2: AgNi type
3: AgNi type/Au-plated

Coil voltage (DC)

- 4H: 4.5 V 05: 5 V 06: 6 V 09: 9 V 12: 12 V 18: 18 V
24: 24 V 48: 48 V 60: 60 V

Note: UL/C-UL/VDE approved type is standard.

TYPES

Contact arrangement	Nominal coil voltage	Part No.	Contact arrangement	Nominal coil voltage	Part No.
1 Form A (AgNi type)	4.5V DC	APF1024H	1 Form C (AgNi type)	4.5V DC	APF3024H
	5V DC	APF10205		5V DC	APF30205
	6V DC	APF10206		6V DC	APF30206
	9V DC	APF10209		9V DC	APF30209
	12V DC	APF10212		12V DC	APF30212
	18V DC	APF10218		18V DC	APF30218
	24V DC	APF10224		24V DC	APF30224
	48V DC	APF10248		48V DC	APF30248
1 Form A (AgNi type/Au-plated)	60V DC	APF10260	1 Form C (AgNi type/Au-plated)	60V DC	APF30260
	4.5V DC	APF1034H		4.5V DC	APF3034H
	5V DC	APF10305		5V DC	APF30305
	6V DC	APF10306		6V DC	APF30306
	9V DC	APF10309		9V DC	APF30309
	12V DC	APF10312		12V DC	APF30312
	18V DC	APF10318		18V DC	APF30318
	24V DC	APF10324		24V DC	APF30324
48V DC	APF10348	48V DC	APF30348		
60V DC	APF10360	60V DC	APF30360		

Standard packing: Tube: 20 pcs.; Case: 1,000 pcs.

RATING

1. Coil data

Nominal coil voltage	Pick-up voltage (at 20°C 68°F)	Drop-out voltage (at 20°C 68°F)	Nominal operating current [±10%] (at 20°C 68°F)	Coil resistance [±10%] (at 20°C 68°F)	Nominal operating power	Max. allowable voltage (at 20°C 68°F)
4.5V DC	Max. 70%V nominal voltage (Initial)	Min. 5%V nominal voltage (Initial)	37.8mA	119Ω	170mW	120%V of nominal voltage
5V DC			34.0mA	147Ω		
6V DC			28.3mA	212Ω		
9V DC			18.9mA	476Ω		
12V DC			14.2mA	847Ω		
18V DC			9.4mA	1,906Ω		
24V DC			7.1mA	3,388Ω	217mW	
48V DC			4.5mA	10,618Ω		
60V DC			2.9mA	20,570Ω		

PF (APF)

2. Specifications

Characteristic	Item	Specifications	
		1 Form A	1 Form C
Contact	Arrangement		
	Contact resistance (Initial)	Max. 100 mΩ (By voltage drop 6 V DC 1A)	
	Contact material	AgNi type, AgNi type/Au-plated	
Rating	Nominal switching capacity (resistive load)	6 A 250 V AC	
	Max. switching power (resistive load)	1,500 VA	
	Max. switching voltage	250V AC	
	Max. switching current	6 A (AC)	
	Nominal operating power	170 mW (5 to 24 V DC), 217 mW (48 V DC), 175 mW (60 V DC)	
	Min. switching capacity (Reference value)*1	100 mA 5 V DC (without Au-plated), 1 mA 1 V DC (with Au-plated)	
Electrical characteristics	Insulation resistance (Initial)	Min. 1,000MΩ (at 500V DC) Measurement at same location as "Initial breakdown voltage" section.	
	Breakdown voltage (Initial)	Between open contacts	1,000 Vrms for 1 min. (Detection current: 10 mA)
		Between contact and coil	4,000 Vrms for 1 min. (Detection current: 10 mA)
	Surge breakdown voltage (Between contact and coil)*2	6,000 V (initial)	
	Temperature rise (at 20°C 68°F)	Max. 45°C 113°F (By resistive method, nominal coil voltage applied to the coil; contact carrying current: 6A.)	
	Operate time (at 20°C 68°F)	Max. 8 ms (Nominal coil voltage applied to the coil, excluding contact bounce time.)	
	Release time (at 20°C 68°F)	Max. 4 ms (Nominal coil voltage applied to the coil, excluding contact bounce time.) (without diode)	
Mechanical characteristics	Shock resistance	Functional	Min. 98 m/s ² (Half-wave pulse of sine wave: 11 ms; detection time: 10μs)
		Destructive	Min. 980 m/s ² (Half-wave pulse of sine wave: 11 ms.)
	Vibration resistance	Functional	10 to 55 Hz at double amplitude of 1 mm (Detection time: 10μs.)
		Destructive	10 to 55 Hz at double amplitude of 1.5 mm
Expected life	Mechanical	Min. 5×10 ⁶ (at 180 cpm)	
	Electrical*3	N.O.: Min. 5×10 ⁴ (at resistive load, 6 cpm and nominal switching capacity)	N.O.: Min. 5×10 ⁴ , N.C.: Min. 3×10 ⁴ (at resistive load, 6 cpm and nominal switching capacity)
Conditions	Conditions for operation, transport and storage*4	Ambient temperature: -40°C to +85°C -40°F to +185°F; Humidity: 5 to 85% R.H. (Not freezing and condensing at low temperature)	
Unit weight		Approx. 5 g .18 oz	

*1 This value can change due to the switching frequency, environmental conditions, and desired reliability level, therefore it is recommended to check this with the actual load.

*2 Wave is standard shock voltage of $\pm 1.2 \times 50\mu s$ according to JEC-212-1981

*3 For cycle lifetime, refer to "Cautions for Use 4)" in NOTES (page 5)

*4 The upper operation ambient temperature limit is the maximum temperature that can satisfy the coil temperature rise value. Refer to "6. Usage, Storage and Transport Conditions" in **AMBIENT ENVIRONMENT** section in **Relay Technical Information**.

REFERENCE DATA

1. Electrical life

Tested sample: APF30224

Load type	Voltage	Current	Ambient temperature	No. of ops.
Resistive load	250V AC	6 A	85°C 185°F	30,000
Inductive load	AC 15	250V AC	25°C 77°F	20,000
	DC 13	24V DC	25°C 77°F	6,000

Notes: 1. Switch contacts are all on N.O. side.

2. AC 15 and DC 13 comply with IEC-60947-5-1 testing conditions.

2. Max. switching capacity

Load Limit Curve

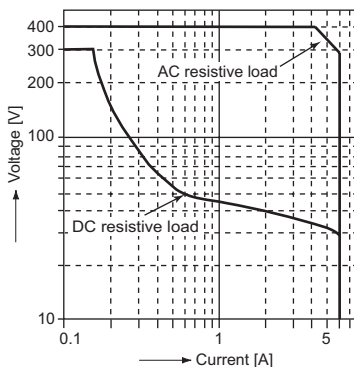

3. Coil temperature rise

Tested sample: APF30224

Measured portion: Inside the coil

Ambient temperature: 28°C 82°F

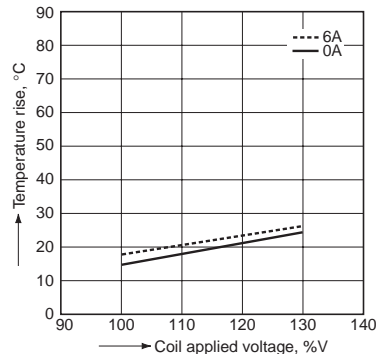

4. Ambient temperature characteristics

Tested sample: APF30224, 6 pcs.

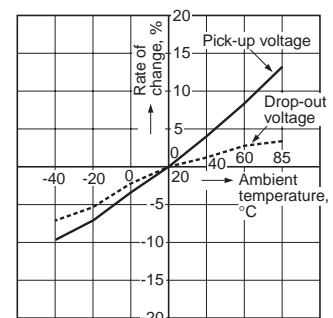

NOTES

■ Usage, transport and storage conditions

1) Temperature:

-40 to +85°C -40 to +185°F

2) Humidity: 5 to 85% RH

(Avoid freezing and condensation.)

The humidity range varies with the temperature. Use within the range indicated in the graph below.

3) Atmospheric pressure: 86 to 106 kPa

Temperature and humidity range for usage, transport, and storage

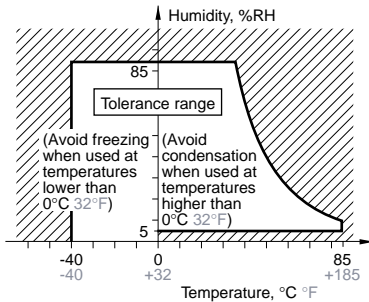

4) Condensation

Condensation forms when there is a sudden change in temperature under high temperature and high humidity conditions. Condensation will cause deterioration of the relay insulation.

5) Freezing

Condensation or other moisture may freeze on the relay when the temperatures is lower than 0°C 32°F.

This causes problems such as sticking of movable parts or operational time lags.

6) Low temperature, low humidity environments

The plastic becomes brittle if the relay is exposed to a low temperature, low humidity environment for long periods of time.

■ Solder and cleaning conditions

1) Please obey the following conditions when soldering automatically.

(1) Preheating: Within 120°C 248°F (solder surface terminal portion) and within 120 seconds

(2) Soldering iron: 260°C±5°C 500°F±41°F (solder temperature) and within 6 seconds (soldering time)

2) Please obey the following conditions when soldering manually.

Thoroughly clean the iron tip.

(1) Soldering iron: 30 to 60 W

(2) Soldering iron tip temperature: 350°C 662°F

(3) Soldering time: within approx. 3 seconds

3) Since this is not a sealed type relay, do not clean it as is. Also, be careful not to allow flux to overflow above the PC board or enter the inside of the relay.

■ Cautions for use

1) For precautions regarding use and explanations of technical terminology, please refer to our web site.

(panasonic-electric-works.net/ac)

2) To ensure good operation, please keep the voltage on the coil ends to ±5% (at 20°C 68°F) of the rated coil operation voltage.

Also, please be aware that the pick-up voltage and drop-out voltage may change depending on the temperature and conditions of use.

3) Keep the ripple rate of the nominal coil voltage below 5%.

4) The cycle lifetime is defined under the standard test condition specified in the JIS C 5442 standard (temperature 15 to 35°C 59 to 95°F, humidity 25 to 75%). Check this with the real device as it is affected by coil driving circuit, load type, activation frequency, activation phase, ambient conditions and other factors.

Also, be especially careful of loads such as those listed below.

(1) When used for AC load-operating and the operating phase is synchronous.

Rocking and fusing can easily occur due to contact shifting.

(2) Highly frequent load-operating

When highly frequent opening and closing of the relay is performed with a load that causes arcs at the contacts, nitrogen and oxygen in the air is fused by the arc energy and HNO₃ is formed. This can corrode metal materials.

Three countermeasures for these are listed here.

- Incorporate an arc-extinguishing circuit.

- Lower the operating frequency

- Lower the ambient humidity

5) Minimum switching capacity provides a guideline for low level load switching.

This value can change due to the switching frequency, environmental conditions, and desired reliability level, therefore it is recommended to check this with the actual load.

6) Heat, smoke, and even a fire may occur if the relay is used in conditions outside of the allowable ranges for the coil ratings, contact ratings, operating cycle lifetime, and other specifications. Therefore, do not use the relay if these ratings are exceeded.

7) If the relay has been dropped, the appearance and characteristics should always be checked before use.

8) Incorrect wiring may cause unexpected events or the generation of heat or flames.

9) The amount of relay operation noise will vary depending on the substrate used for mounting. Please use after verifying with the relay mounted on the substrate.

We recommend this extra manufacturers socket. It is only available in Europe.

ACCESSORIES

SOCKET FOR SLIM POWER RELAYS

PF (APF) relay socket

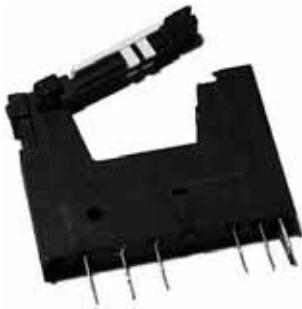

APF1-PS-GD

FEATURES

1. Socket incorporates LED-indication
2. It is equipped with a hold-down clip and an integrated casting mechanism
3. Suitable for PCB-mounting

SPECIFICATIONS

Item	Specifications
LED	
Nominal voltage	24 V DC
Nominal current	appr. 4.2 mA
Diameter	3 mm
Color	green*

DIMENSIONS

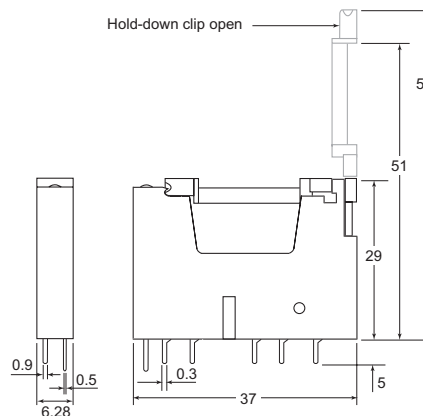

PIN LAYOUT

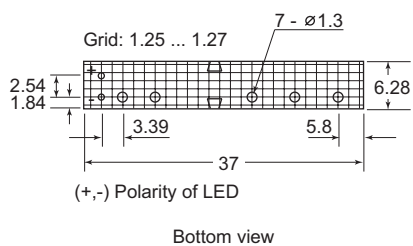

HANDLING

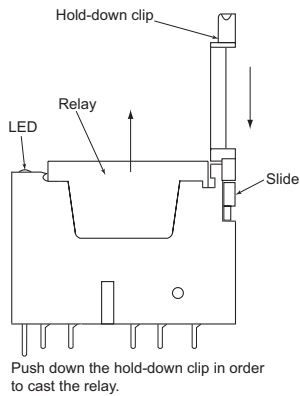

NOTE: The PF relay approvals do not apply to the PF relay socket.