



Monitoring relays - GAMMA series

Multifunction

Monitoring of phase sequence and phase failure

Monitoring of asymmetry selectable

Connection of neutral wire optional

Detection of loss of neutral wire

Supply voltage selectable via power modules / switching power supply

2 change-over contacts

Width 22.5mm

Industrial design



Technical data

1. Functions

Voltage monitoring in 3-phase mains with adjustable thresholds, adjustable tripping delay, monitoring of phase sequence and phase failure, monitoring of asymmetry with adjustable threshold and the following functions which are selectable by means of rotary switch:

UNDER	Undervoltage monitoring
UNDER+SEQ	Undervoltage monitoring and monitoring of phase sequence
WIN	Monitoring of window between Min and Max
WIN+SEQ	Monitoring the window between Min and Max and monitoring of phase sequence

2. Time ranges

	Adjustment range
Start-up suppression time:	-
Tripping delay:	0.1s 10s

3. Indicators

Red LED ON/OFF:	indication of failure of the corresponding threshold
Red LED flashes:	indication of tripping delay of the corresponding threshold
Yellow LED ON/OFF:	indication of relay output

4. Mechanical design

Self-extinguishing plastic housing, IP rating IP40
 Mounted on DIN-Rail TS 35 according to EN 60715
 Mounting position: any
 Shockproof terminal connection according to VBG 4 (PZ1 required), IP rating IP20
 Tightening torque: max. 1Nm
 Terminal capacity:
 1 x 0.5 to 2.5mm² with/without multicore cable end
 1 x 4mm² without multicore cable end
 2 x 0.5 to 1.5mm² with/without multicore cable end
 2 x 2.5mm² flexible without multicore cable end

5. Input circuit

Supply voltage:	terminals A1-A2 (galvanically separated) selectable via power modules TR2 or switching power supply SNT2
12 to 400V AC	
24V DC	
Tolerance:	according to specification of power module / switching power supply
Rated frequency:	according to specification of power module / switching power supply
Rated consumption:	2VA (1W)
Duration of operation:	100%
Reset time:	500ms
Wave form for AC:	Sinus
Residual ripple for DC:	10%
Drop-out voltage:	>30% of the supply voltage
Overvoltage category:	III (in accordance with IEC 60661-1)
Rated surge voltage:	4kV

6. Output circuit

2 potential free change-over contacts

Rated voltage:	250V AC
Switching capacity:	750VA (3A / 250V AC)
If the distance between the devices is less than 5mm!	
Switching capacity:	1250VA (5A / 250V AC)
If the distance between the devices is greater than 5mm!	
Fusing:	5A fast acting
Mechanical life:	20 x 10 ⁶ operations
Electrical life:	2 x 10 ⁵ operations at 1000VA resistive load
Switching frequency:	max. 60/min at 100VA resistive load max. 6/min at 1000VA resistive load (in accordance with IEC 60947-5-1)
Overvoltage category:	III (in accordance with IEC 60664-1)
Rated surge voltage:	4kV

7. Measuring circuit

Fusing:	max. 20A (in accordance with UL 508)
Measured variable:	AC Sinus (48 to 63Hz)
Input:	terminals (N)-L1-L2-L3 (G2PM115VSY20) terminals (N)-L1-L2-L3 (G2PM230VSY20) terminals (N)-L1-L2-L3 (G2PM400VSY20)
Overload capacity:	3(N)~173/100V (G2PM115VSY20) 3(N)~345/199V (G2PM230VSY20) 3(N)~600/346V (G2PM400VSY20)
Input resistance:	220kΩ (G2PM115VSY20) 470kΩ (G2PM230VSY20) 1MΩ (G2PM400VSY20)
Switching threshold	Max: -20% to +30% of UN Min: -30% to +20% of UN
Asymmetry:	5% to 25%
Overvoltage category:	III (in accordance with IEC 60664-1)
Rated surge voltage:	4kV

8. Accuracy

Base accuracy:	≤3% (of maximum scale value)
Frequency response:	-
Adjustment accuracy:	≤5% (of maximum scale value)
Repetition accuracy:	≤2%
Voltage influence:	-
Temperature influence:	≤0.05% / °C

9. Ambient conditions

Ambient temperature:	-25 to +55°C (in accordance with IEC 60068-1) -25 to +40°C (in accordance with UL 508)
Storage temperature:	-25 to +70°C
Transport temperature:	-25 to +70°C
Relative humidity:	15% to 85% (in accordance with IEC 60721-3-3 class 3K3) (in accordance with IEC 60664-1)
Pollution degree:	3 (in accordance with IEC 60664-1)
Vibration resistance:	10 to 55Hz 0.35mm (in accordance with IEC 60068-2-6)
Shock resistance:	15g 11ms (in accordance with IEC 60068-2-27)

Functions

For all the functions the LEDs MIN and MAX are flashing alternating, when the minimum value for the measured voltage was chosen to be greater than the maximum value. If a failure already exists when the device is activated, the output relays remain in off-position and the LED for the corresponding threshold is illuminated.

Under voltage monitoring (UNDER, UNDER+SEQ)

When the measured voltage (mean value of phase-to-phase voltages) falls below the value adjusted at the MIN-regulator, the set interval of the tripping delay (DELAY) begins (red LED MIN flashes). After the interval has expired (red LED MIN illuminated), the output relays switch into off-position (yellow LED not illuminated). The output relays again switch into on-position (yellow LED illuminated), when the measured voltage exceeds the value adjusted at the MAX-regulator.

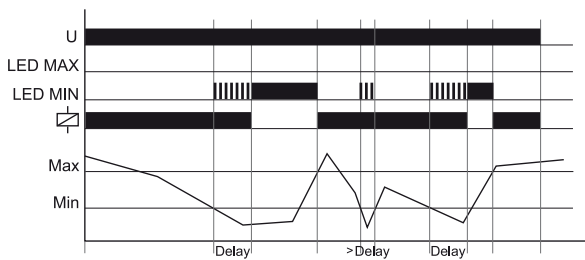

Window function (WIN, WIN+SEQ)

The output relays switch into on-position (yellow LED illuminated) when the measured voltage (mean value of phase-to-phase voltages) exceeds the value adjusted at the MIN-regulator. When the measured voltage exceeds the value adjusted at the MAX-regulator, the set interval of the tripping delay (DELAY) begins (red LED MAX flashes). After the interval has expired (red LED MAX illuminated), the output relays switch into off-position (yellow LED not illuminated). The output relays again switch into on-position (yellow LED illuminated) when the measured voltage falls below the value adjusted at the MAX-regulator (red LED MAX not illuminated). When the measured voltage falls below the value adjusted at the MIN-regulator, the set interval of the tripping delay (DELAY) begins again (red LED MIN flashes). After the interval has expired (red LED MIN illuminated), the output relays switch into off-position (yellow LED not illuminated).

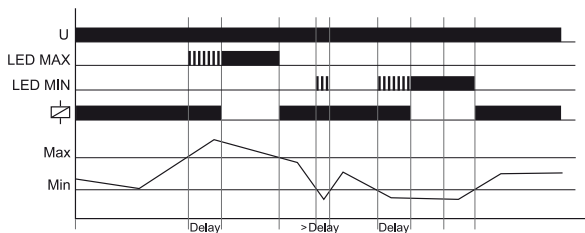

Phase sequence monitoring (SEQ)

Phase sequence monitoring is selectable for all functions. If a change in phase sequence is detected (red LED SEQ illuminated), the output relays switch into off-position immediately (yellow LED not illuminated).

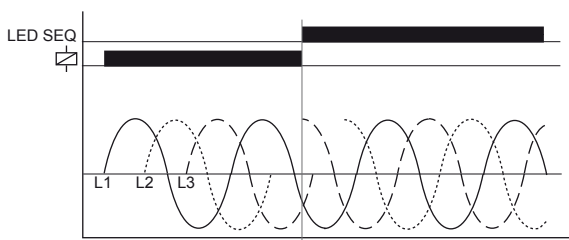

Phase failure monitoring (SEQ)

If one of the phase voltages fails, the set interval of the tripping delay (DELAY) begins (red LED SEQ flashes). After the interval has expired (red LED SEQ illuminated), the output relays switch into off-position (yellow LED not illuminated). Reverse voltages of a consumer (e.g. a motor which continues to run on two phases only) do not effect the disconnection but can be monitored by using a proper value for the asymmetry.

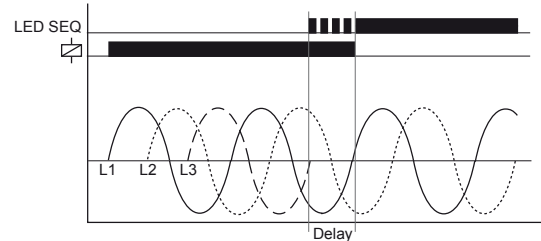

Asymmetry monitoring

If the asymmetry of the phase-to-phase voltages exceeds the value set at the ASYM-regulator, the set interval of the tripping delay (DELAY) begins (red LED ASYM flashes). After the interval has expired (red LED ASYM illuminated), the output relays switch into off-position (yellow LED not illuminated). If the neutral wire is connected to the device, the asymmetry of the phase voltages referred to the neutral wire (Y-voltage) is monitored also. In that case both values of the asymmetry are evaluated and if one of the values exceeds the value set at the ASYM-regulator, the set interval of the tripping delay (DELAY) begins (red LED ASYM flashes). After the interval has expired (red LED ASYM illuminated), the output relays switch into off-position (yellow LED not illuminated).

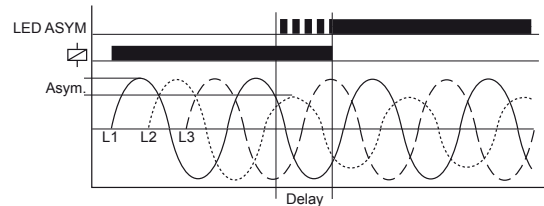

Loss of neutral wire by means of evaluation of asymmetry

A break of the neutral wire between power line and machinery is detected as soon as asymmetry between phase-to-phase voltage and neutral wire occurs. If the asymmetry exceeds the value set at the ASYM-regulator, the set interval of the tripping delay (DELAY) begins (red LED ASYM flashes). After the interval has expired (red LED ASYM illuminated), the output relays switch into off-position (yellow LED not illuminated). A break of the neutral wire between our device and the machinery can not be detected.

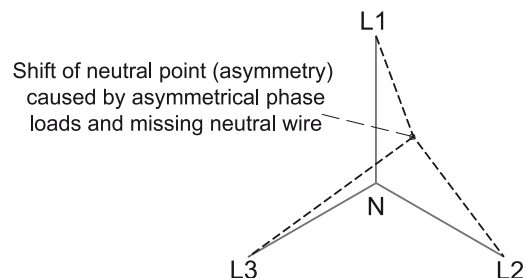

Connections

G2PM400VSY20 24-240V, supply voltage 24V AC/DC

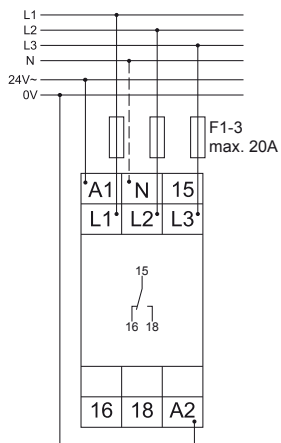

Dimensions

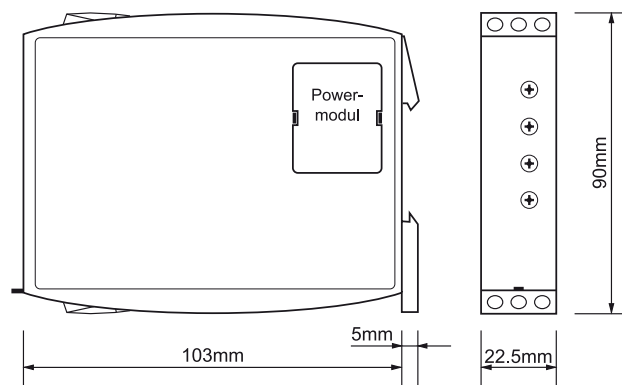

G2PM400VSY20 24-240V, supply voltage 230V AC

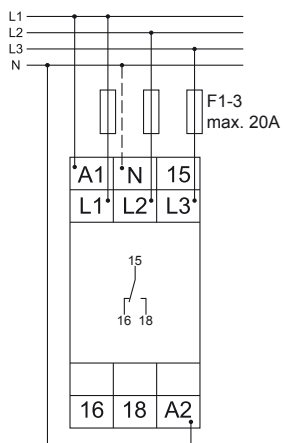

G2PM400VSY20 with power modul 400V AC

