

Time switches 16 A



Heating and cooling



Shop displays



Lighting for parks



Streetlights and car park lighting



School bells



12
SERIES

Mechanical time switches

- Daily time setting*
- Weekly time setting**

Type 12.01

- Daily
- 1 CO 16 A
- 35.8 mm wide
- 35 mm rail mount

Type 12.11

- Daily
- 1 NO 16 A
- 17.5 mm wide
- 35 mm rail mount

Type 12.31-0000

- Daily
- 1 CO 16 A
- 72 x 72 mm
- Front panel mount

Type 12.31-0007

- Weekly
- 1 CO 16 A
- 72 x 72 mm
- Front panel mount

- Minimum time interval setting:
1 h (12.31-0007)
30 min (12.01)
15 min (12.11 - 12.31-0000)

* Same program every day

** Different program possible for each of the 7 days of the week

For outline drawing see page 15

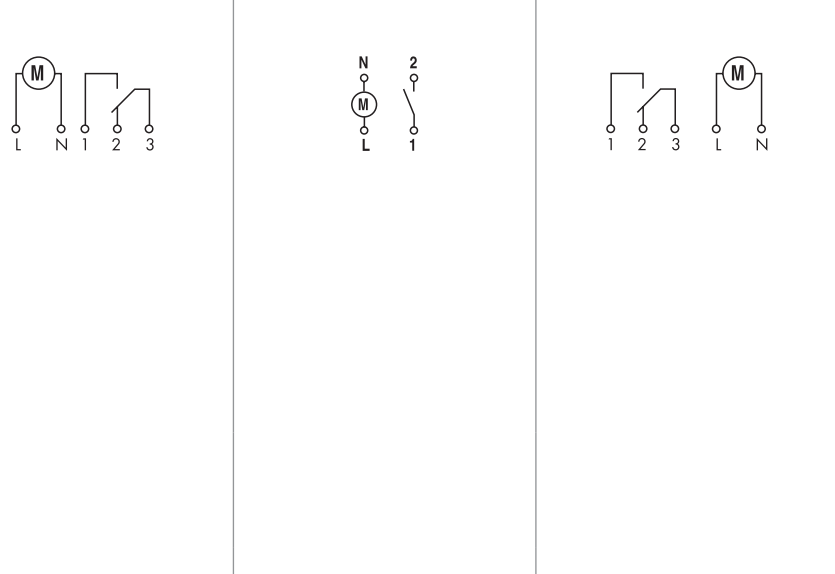
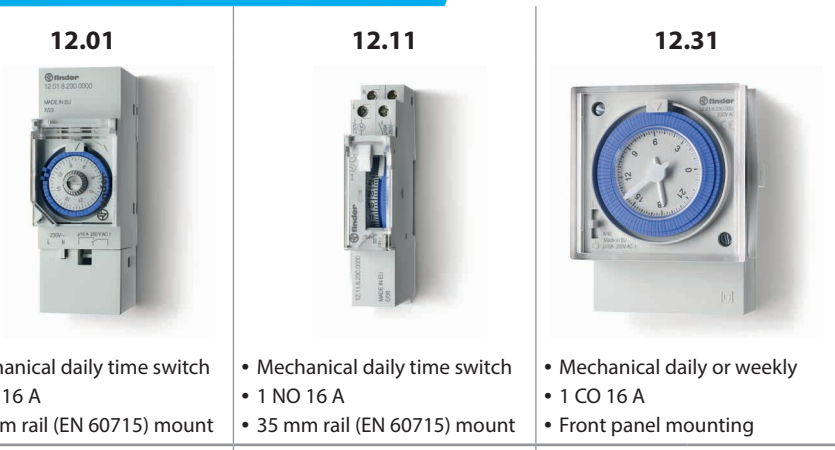

Contact specification				
Contact configuration		1 CO (SPDT)	1 NO (SPST-NO)	1 CO (SPDT)
Rated current/Maximum peak current	A	16/—	16/30	16/—
Rated voltage/ Maximum switching voltage	V AC	250/—	250/—	250/—
Rated load AC1	VA	4000	4000	4000
Rated load AC15 (230 V AC)	VA	750	420	420
Nominal lamp rating:				
	incandescent (230 V) W	2000 (NO contact)	2000	2000
	compensated fluorescent (230 V) W	750 (NO contact)	750	750
	uncompensated fluorescent (230 V) W	1000 (NO contact)	1000	1000
	halogen (230 V) W	2000 (NO contact)	2000	2000
Minimum switching load	mW (V/mA)	1000 (10/10)	1000 (10/10)	1000 (10/10)
Standard contact material				
		AgSnO ₂	AgSnO ₂	AgSnO ₂
Supply specification				
Nominal voltage (U _N)	V AC (50/60 Hz)	230	230	120 - 230
	V DC	—	—	—
Rated power AC/DC	VA (50 Hz)/W	2/—	2/—	2/—
Operating range	AC (50 Hz)	(0.85...1.1)U _N	(0.85...1.1)U _N	(0.85...1.1)U _N
	DC	—	—	—
Technical data				
Electrical life at rated load in AC1	cycles	50 · 10 ³	50 · 10 ³	50 · 10 ³
Type of time switch		daily	daily	daily weekly
Switching intervals /day		48	96	96 24 (168/week)
Minimum switching interval	min	30	15	15 60
Accuracy	s/day	1.5	1.5	1.5
Ambient temperature range	°C	-5...+50	-5...+50	-10...+50
Protection category		IP 20	IP 20	IP 20
Approvals (according to type)				

Type 12.51
Digital (analogue-style) time switch,
daily/weekly programming

- Can be programmed in "Classic" mode via the joystick, or "Smart" mode via smartphones with NFC communication
- Minimum time interval setting - 30 minutes
- Easily configurable for daily or weekly programming

Type 12.81
Digital Astro-switch

- Can be programmed in "Classic" mode via the joystick, or "Smart" mode via smartphones with NFC communication
- Astro program: calculation of sunrise and sunset times through date, time and location coordinates
- Option for Astro ON period override, by timeswitch
- Location coordinates easily settable for most European countries through post codes
- Offset function: allows programming of switching times offset from the astronomic time (by up to 90 min, in 10 min steps)
- Summer/Winter European, Australian, Brazilian time
- 1 CO 16 A output contact
- LCD status indication, set-up and programming
- Lock with a 4-digit PIN
- Back-light display
- Internal battery for set-up and programming without supply, easily replaceable from the front
- Protective separation between supply and contacts
- 35 mm wide
- 35 mm rail (EN 60715) mount
- Cadmium free contact material

For outline drawing see page 15

Contact specification

Contact configuration		1 CO (SPDT)	1 CO (SPDT)
Rated current/Maximum peak current	A	16/30 (120 A - 5 ms)	16/30 (120 A - 5 ms)
Rated voltage/ Maximum switching voltage	V AC	250/400	250/400
Rated load AC1	VA	4000	4000
Rated load AC15 (230 V AC)	VA	750	750
Nominal lamp rating:			
230 V incandescent/halogen W		2000	2000
fluorescent tubes with electronic ballast W		1000	1000
fluorescent tubes with electromagnetic ballast W		750	750
CFL W		400	400
230 V LED W		400	400
LV halogen or LED with electronic ballast W		400	400
LV halogen or LED with electromagnetic ballast W		800	800
Minimum switching load	mW (V/mA)	1000 (10/10)	1000 (10/10)
Standard contact material		AgSnO ₂	AgSnO ₂

Supply specification

Nominal voltage (U _N)	V AC (50/60 Hz)	110...230	110...230
	V DC	110...230	110...230
Rated power AC/DC	VA (50 Hz)/W	2.8/0.9	2.8/0.9
Operating range	V AC (50 Hz)	88...264	88...264
	V DC	88...264	88...264

Technical data

Electrical life at rated load in AC1	cycles	100 · 10 ³	100 · 10 ³
Switching intervals		48	—
Minimum switching interval	min	30	—
Accuracy	s/day	1	1
Communication protocol		NFC	NFC
Ambient temperature range	°C	-20...+50 (see page 10, diagram L12)	-20...+50 (see page 10, diagram L12)
Protection category		IP 20	IP 20

Approvals (according to type)

- Digital time switch
- 1 CO 16 A

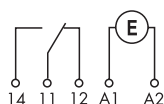

- Digital Astro-switch
- 1 CO 16 A



Digital time switch, weekly programming
- Can be programmed in "Classic" mode via the joystick, or "Smart" mode via smartphones with NFC communication

Type 12.61

- 1 CO 16 A

Type 12.62

- 2 CO 16 A

- Functions:
Switch ON, Switch OFF
Pulse: 1s...59 min
- Minimum time interval setting - 1 minute
- Summer/Winter European, Australian, Brazilian time
- LCD status indication, set-up and programming
- Lock with a 4-digit PIN
- Back-light display
- Internal battery for set-up and programming without supply, easily replaceable from the front
- Protective separation between supply and contacts
- 35 mm wide
- 35 mm rail (EN 60715) mount
- Cadmium free contact material

For outline drawing see page 16

Contact specification

Contact configuration		1 CO (SPDT)	2 CO (DPDT)
Rated current/Maximum peak current	A	16/30 (120 A - 5 ms)	16/30 (120 A - 5 ms)
Rated voltage/ Maximum switching voltage	V AC	250/400	250/400
Rated load AC1	VA	4000	4000
Rated load AC15 (230 V AC)	VA	750	750
Nominal lamp rating:			
230 V incandescent/halogen W		2000	2000
fluorescent tubes with electronic ballast W		1000	1000
fluorescent tubes with electromagnetic ballast W		750	750
CFL W		400	400
230 V LED W		400	400
LV halogen or LED with electronic ballast W		400	400
LV halogen or LED with electromagnetic ballast W		800	800
Minimum switching load	mW (V/mA)	1000 (10/10)	1000 (10/10)
Standard contact material		AgSnO ₂	AgSnO ₂

Supply specification

Nominal voltage (U _N)	V AC (50/60 Hz)	12...24	110...230	110...230
	V DC	12...24	110...230	110...230
Rated power AC/DC	VA (50 Hz)/W	2.8/0.9		2.8/0.9
Operating range	V AC (50 Hz)	10...30	88...253	88...253
	V DC	10...30	88...253	88...253

Technical data

Electrical life at rated load in AC1	cycles	100 · 10 ³	100 · 10 ³
Type of time switch		Weekly	Weekly
Memory locations for switching times		50	50
Minimum internal setting	min	1	1
Accuracy	s/day	1	1
Communication protocol		NFC	NFC
Ambient temperature range	°C	-20...+50 (see page 10, diagram L12)	-20...+50 (see page 10, diagram L12)
Protection category		IP 20	IP 20

Approvals (according to type)



NEW 12.61

- Weekly programming
- 1 CO 16 A
- Switch ON, Switch OFF, Pulse

NEW 12.62

- Weekly programming
- 2 CO 16 A
- Switch ON, Switch OFF, Pulse

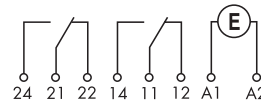
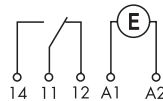

Weekly Astro time switch
 - Can be programmed in "Classic" mode via the joystick, or "Smart" mode via smartphones with NFC communication
 - "Astro" program: calculation of sunrise and sunset times through date, time and location coordinates

Type 12.A1
 - 1 CO 16 A

Type 12.A2
 - 2 CO 16 A

Type 12.B2
 - 2 CO 16 A

- Functions: "Astro" ON, "Astro" OFF, Switch ON, Switch OFF, Pulse: 1s...59 min
- Location coordinates easily settable for most European countries through Post codes
- Offset function: allows programming of switching times offset from the astronomic time (by up to 90 min, in 1 min step)
- Minimum time interval setting - 1 minute
- Summer/Winter European, Australian, Brazilian time
- LCD status indication, set-up and programming
- Lock with a 4-digit PIN
- Back-light display
- Internal battery for set-up and programming without supply, easily replaceable from the front
- Protective separation between supply and contacts
- 35 mm wide
- 35 mm rail (EN 60715) mount
- Cadmium free contact material

For outline drawing see page 15, 16

Contact specification

Contact configuration	1 CO (SPDT)	2 CO (DPDT)	2 CO (DPDT)
Rated current/Maximum peak current	A 16/30 (120 A - 5 ms)	16/30 (120 A - 5 ms)	16/30 (120 A - 5 ms)
Rated voltage/Maximum switching voltage	V AC 250/400	250/400	250/400
Rated load AC1	VA 4000	4000	4000
Rated load AC15 (230 V AC)	VA 750	750	750
Nominal lamp rating:			
230 V incandescent/halogen W	2000	2000	2000
fluorescent tubes with electronic ballast W	1000	1000	1000
fluorescent tubes with electromagnetic ballast W	750	750	750
CFL W	400	400	400
230 V LED W	400	400	400
LV halogen or LED with electronic ballast W	400	400	400
LV halogen or LED with electromagnetic ballast W	800	800	800
Minimum switching load	mW (V/mA) 1000 (10/10)	1000 (10/10)	1000 (10/10)
Standard contact material	AgSnO ₂	AgSnO ₂	AgSnO ₂

Supply specification

Nominal voltage (U _N)	V AC (50/60 Hz)	110...230	12...24 110...230	110...230
	V DC	110...230	12...24 110...230	110...230
Rated power AC/DC	VA (50 Hz)/W	2.8/0.9	2.8/0.9	2.8/0.9
Operating range	V AC (50 Hz)	88...253	10...30 88...253	88...253
	V DC	88...253	10...30 88...253	88...253

Technical data

Electrical life at rated load in AC1	cycles	100 · 10 ³	100 · 10 ³	100 · 10 ³
Type of time switch		Weekly	Weekly	Yearly
Memory locations for switching times		50	50	100
Minimum internal setting	min	1	1	1
Accuracy	s/day	1	1	1
Communication protocol		NFC	NFC	Bluetooth 5, NFC
Ambient temperature range	°C	-20...+50 (see page 10, diagram L12)	-20...+50 (see page 10, diagram L12)	-20...+50 (see page 10, diagram L12)
Protection category		IP 20	IP 20	IP 20

Approvals (according to type)



- Weekly programming
- 1 CO 16 A
- Switch ON, Switch OFF, Pulse

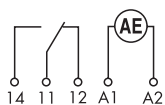

- Weekly programming
- 2 CO 16 A
- Switch ON, Switch OFF, Pulse

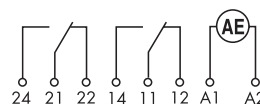

- Yearly programming
- 2 CO 16 A
- Switch ON, Switch OFF, Pulse, Astro ON, Astro OFF, Astro Pulse

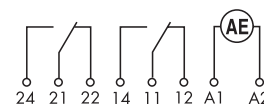

Weekly Astro time switch

- Suitable for applications where a variable light level is required - programmable via smartphone with NFC communications
- Compatible with power supply/ballasts with 0-10V or PWM inputs

Type 12.A4

- 1 analog output: 0-10V or PWM
- Functions:
"Astro" ON, "Astro" OFF, ON/OFF
- Location coordinates easily settable for most European countries through Post codes
- Offset function: allows programming of switching times offset from the astronomic time (by up to 90 min, in 1 min step)
- Minimum time interval setting - 1 minute
- 50 storable programs
- Summer/Winter European, Australian, Brazilian time
- LCD status indication, set-up and programming
- Lock with a 4-digit PIN
- Back-light display
- Internal battery for set-up and programming without supply, easily replaceable from the front
- Protective separation between supply and contacts
- 35 mm wide
- 35 mm rail (EN 60715) mount
- Cadmium free contact material

NEW 12.A4



- Weekly programming
- 1 analog output: 0-10V or PWM

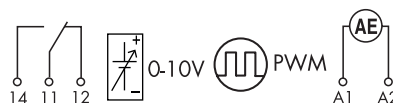

For outline drawing see page 16

Analogue output characteristics

Output signal	0-10 V, 10mA max
Output signal	PWM 30 V, 20 mA max

Contact output characteristics

Contact configuration	1 CO (SPST)
Rated current/Maximum peak current	A 16/30 (120 A - 5 ms)
Rated voltage/Maximum switching voltage	V AC 250/400
Rated load AC1	VA 4000
Rated load AC15 (230 V AC)	VA 750
Minimum switching load	mW (V/mA) 1000 (10/10)
Standard contact material	AgSnO ₂

Supply specification

Nominal voltage (U _N)	V AC (50/60 Hz)	110...230
	V DC	110...230
Rated power AC/DC	VA (50 Hz)/W	2.8/0.9
Operating range	V AC (50 Hz)	90...264
	V DC	90...264

Technical data

Type of time switch	Weekly
Memory locations for switching times	50
Minimum switching interval	min 1
Accuracy	s/day 1
Communication protocol	NFC
Ambient temperature range	°C -20...+50
Protection category	IP 20

Approvals (according to type)



Electronic digital time switches**- 1 Weekly time setting****Type 12.71**

- 1 CO 16 A
- 17.8 mm wide
- Minimum time interval setting - 1 minute
- Internal battery for set-up without supply
- Pulse output function:
1 s...59:59(mm:ss)
- Automatic adjustment for daylight saving
- 35 mm rail (EN 60715) mount

12.71

- Digital weekly time switch
- 1 CO 16 A
- 17.8 mm wide

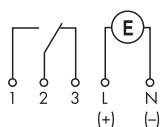

For outline drawing see page 15

Contact specification

Contact configuration	1 CO (SPDT)	
Rated current/Maximum peak current	A	16/30
Rated voltage/ Maximum switching voltage	V AC	250/—
Rated load AC1	VA	4000
Rated load AC15 (230 V AC)	VA	420
Nominal lamp rating:		
230 V incandescent/halogen W	400	
fluorescent tubes with electronic ballast W	100	
fluorescent tubes with electromagnetic ballast W	100	
CFL W	50	
230 V LED W	50	
LV halogen or LED with electronic ballast W	50	
LV halogen or LED with electromagnetic ballast W	100	
Minimum switching load	mW (V/mA)	1000 (10/10)
Standard contact material	AgNi	

Supply specification

Nominal voltage (U _N)	V AC (50/60 Hz)	—	230
	V AC/DC	24	—
Rated power AC/DC	VA (50 Hz)/W	1.4/1.4	2/—
Operating range	AC (50 Hz)	(0.9...1.1)U _N	(0.85...1.1)U _N
	DC	(0.9...1.1)U _N	—

Technical data

Electrical life at rated load in AC1	cycles	50 · 10 ³
Type of time switch	weekly	
Memory locations for switching times*	30	
Minimum switching interval	min	1
Accuracy	s/day	0.5
Ambient temperature range	°C	-30...+55
Protection category	IP 20	

Approvals (according to type)

* Switching times in memory may be used more than once i.e. when selected for different days.

Ordering information

Example: 12 series digital (analogue style) time switch, 1 CO 16 A contact, (110...230)V AC/DC supply

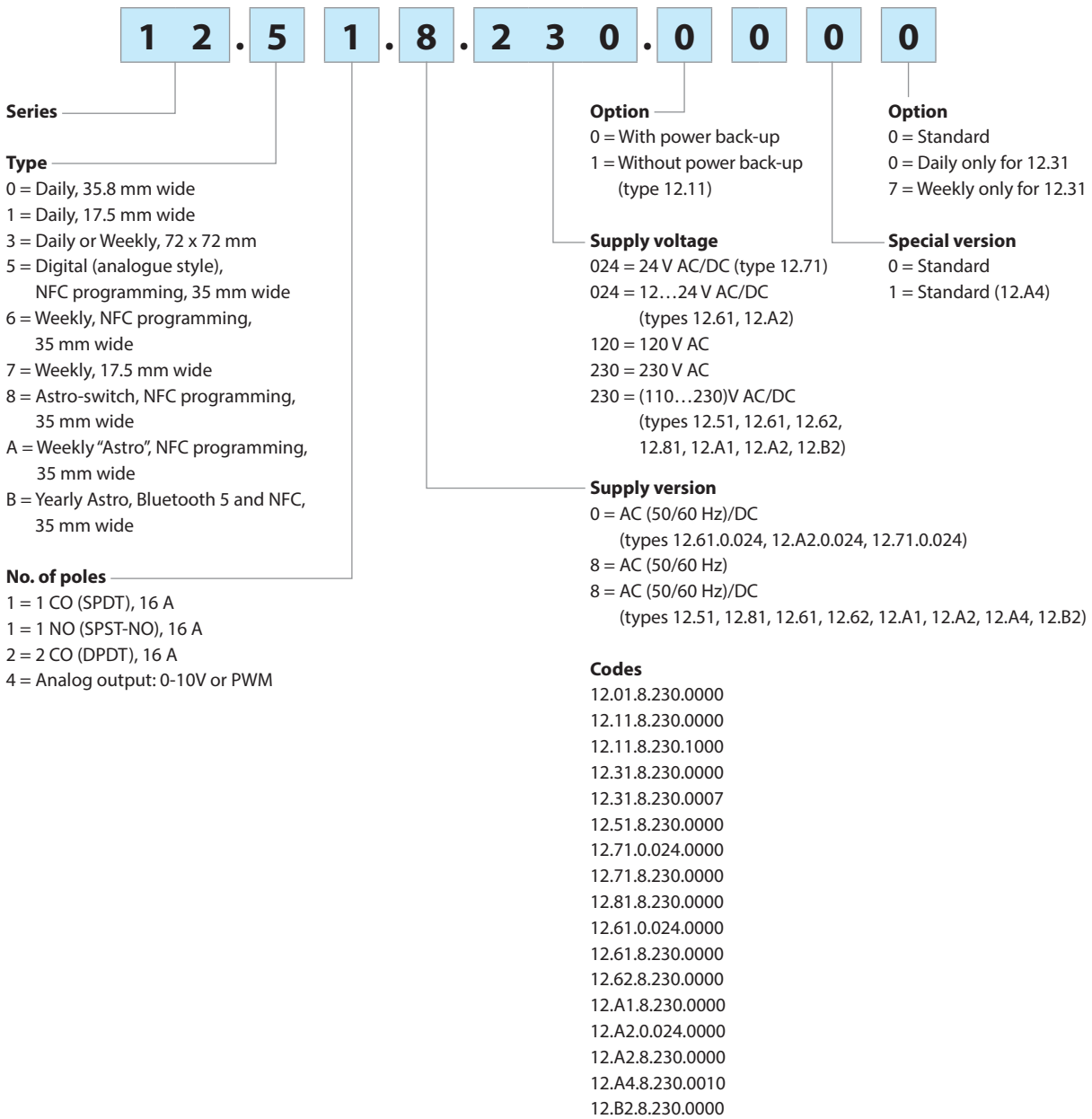

Technical data

Insulation		12.51, 12.61, 12.62, 12.81, 12.A1, 12.A2, 12.A4, 12.B2		12.01, 12.11, 12.31, 12.71	
Dielectric strength between supply and contacts	V AC	4000		4000	
Dielectric strength between open contacts	V AC	1000		1000	
Rated impulse voltage (between supply and contacts)	kV/(1.2/50) μ s	6		6	
Rated impulse voltage (between open contacts)	kV/(1.2/50) μ s	1.5		1.5	
EMC specifications					
Type of test		Reference standard			
Electrostatic discharge	contact discharge	EN 61000-4-2	4 kV	6 kV	
	air discharge	EN 61000-4-2	8 kV	8 kV	
Radiated electromagnetic field (80...1000 MHz)		EN 61000-4-3	10 V/m	10 V/m	
Fast transients (burst 5/50 ns, 5 and 100 kHz)		EN 61000-4-4	4 kV	4 kV	
Voltage pulses on supply terminals (surge 1.2/50 μ s)	common mode	EN 61000-4-5	4 kV	2 kV	
	differential mode	EN 61000-4-5	4 kV	2 kV	
Radiofrequency common mode voltage (0.15...80 MHz)		EN 61000-4-6	10 V	10 V	
Voltage dips	70% U_N , 40% U_N	EN 61000-4-11	10 cycles	10 cycles	
Short interruptions		EN 61000-4-11	10 cycles	10 cycles	
Radio frequency conducted emissions	0.15...30 MHz	EN 55014	class B	class B	
Radiated emissions		30...1000 MHz	EN 55014	class B	class B
Terminals					
Screw torque		Nm	0.8	1.2	
Max. wire size		mm ²	AWG	mm ²	AWG
	solid cable	1 x 6 / 2 x 4	1 x 10 / 2 x 12	1 x 6 / 2 x 4	1 x 10 / 2 x 12
	stranded cable	1 x 4 / 2 x 2.5	1 x 12 / 2 x 14	1 x 6 / 2 x 2.5	1 x 10 / 2 x 14
Wire strip length		mm	9		
Other data					
Power back-up (Battery life)		6 years (12.51, 12.61, 12.62, 12.81, 12.A1, 12.A2, 12.A4, 12.71, 12.B2)			
Battery type		CR 2032, 3 V, 230 mAh (12.51, 12.61, 12.62, 12.81, 12.A1, 12.A2, 12.A4, 12.B2)			
Power back-up		100 h (12.01, 12.11, 12.31 - following 80 h continuous energisation)			
Power lost to the environment		12.51, 12.61, 12.81, 12.A1	12.62, 12.A2, 12.A4, 12.B2	12.01, 12.11, 12.31	12.71
	in stand-by W	0.2	0.2	—	—
	without contact current W	0.9	0.9	1.5	2
	with rated current W	1.5	2.1	2.5	3 (for 1 pole)

L 12 - Rated current v ambient temperature

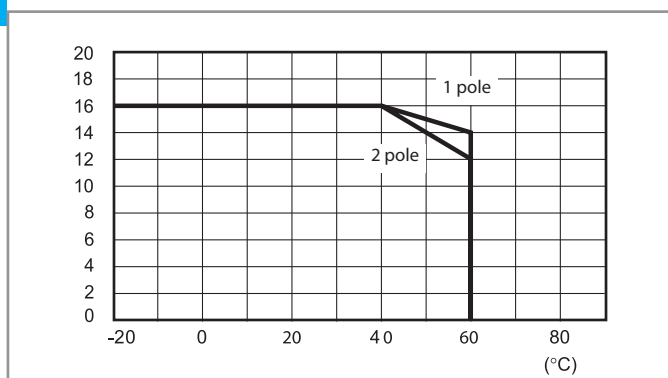

Wiring diagrams

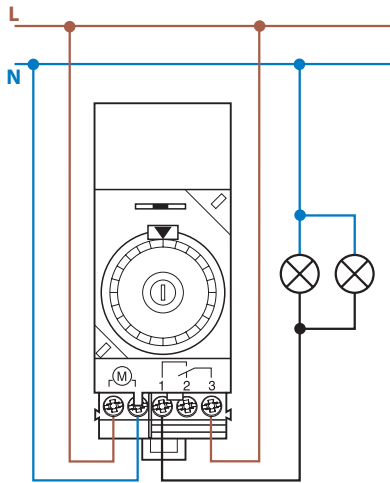

Type 12.01

Selector switch:

- ⊖ = Permanently OFF
- AUTO = Automatic
- I = Permanently ON

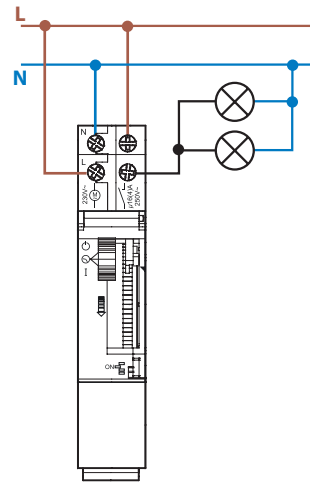

Type 12.11

Selector switch:

- ⊖ = Permanently OFF
- ⊖ = Automatic
- I = Permanently ON

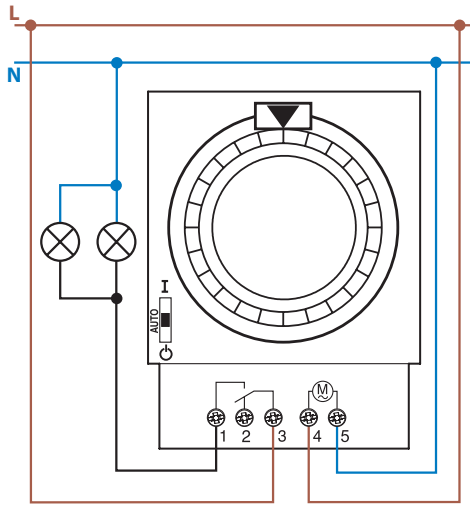

Type 12.31

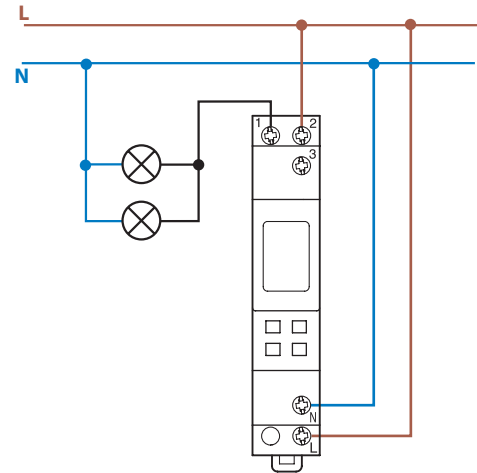

Type 12.71

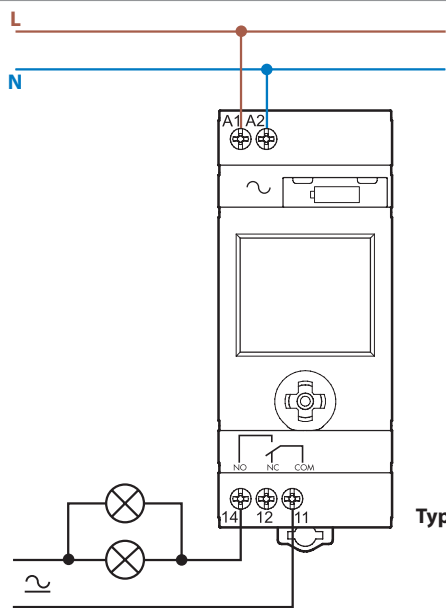

**Types 12.51
12.81**

Wiring diagrams

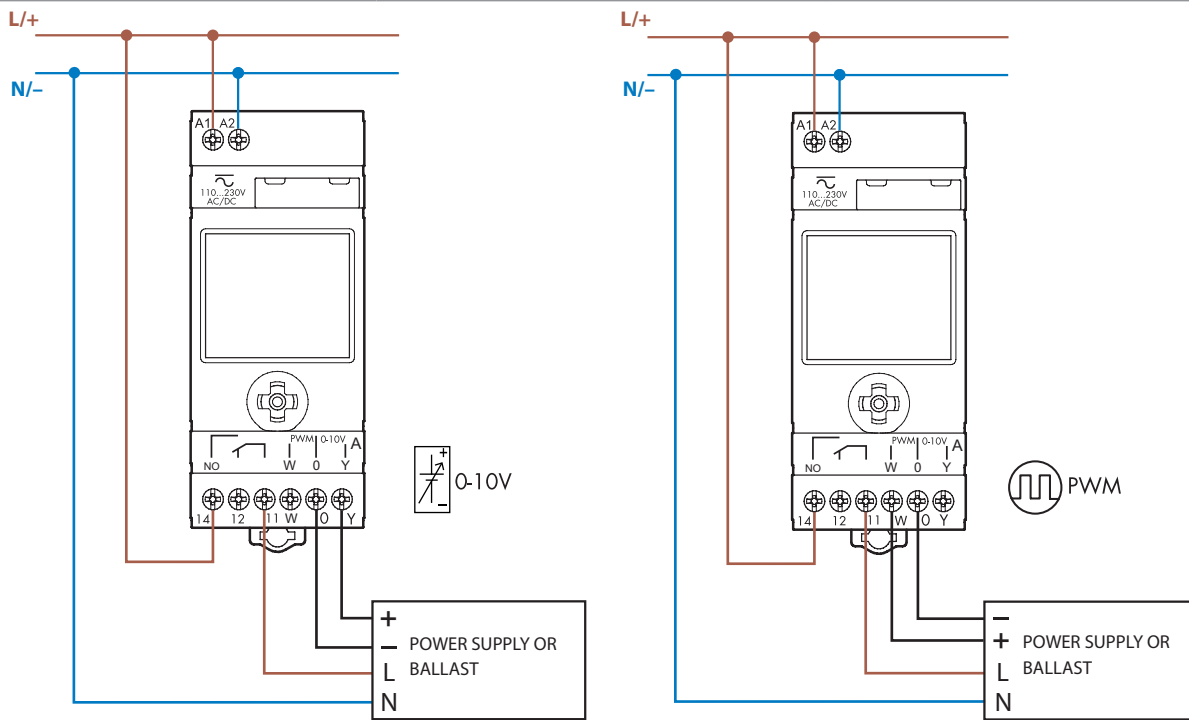
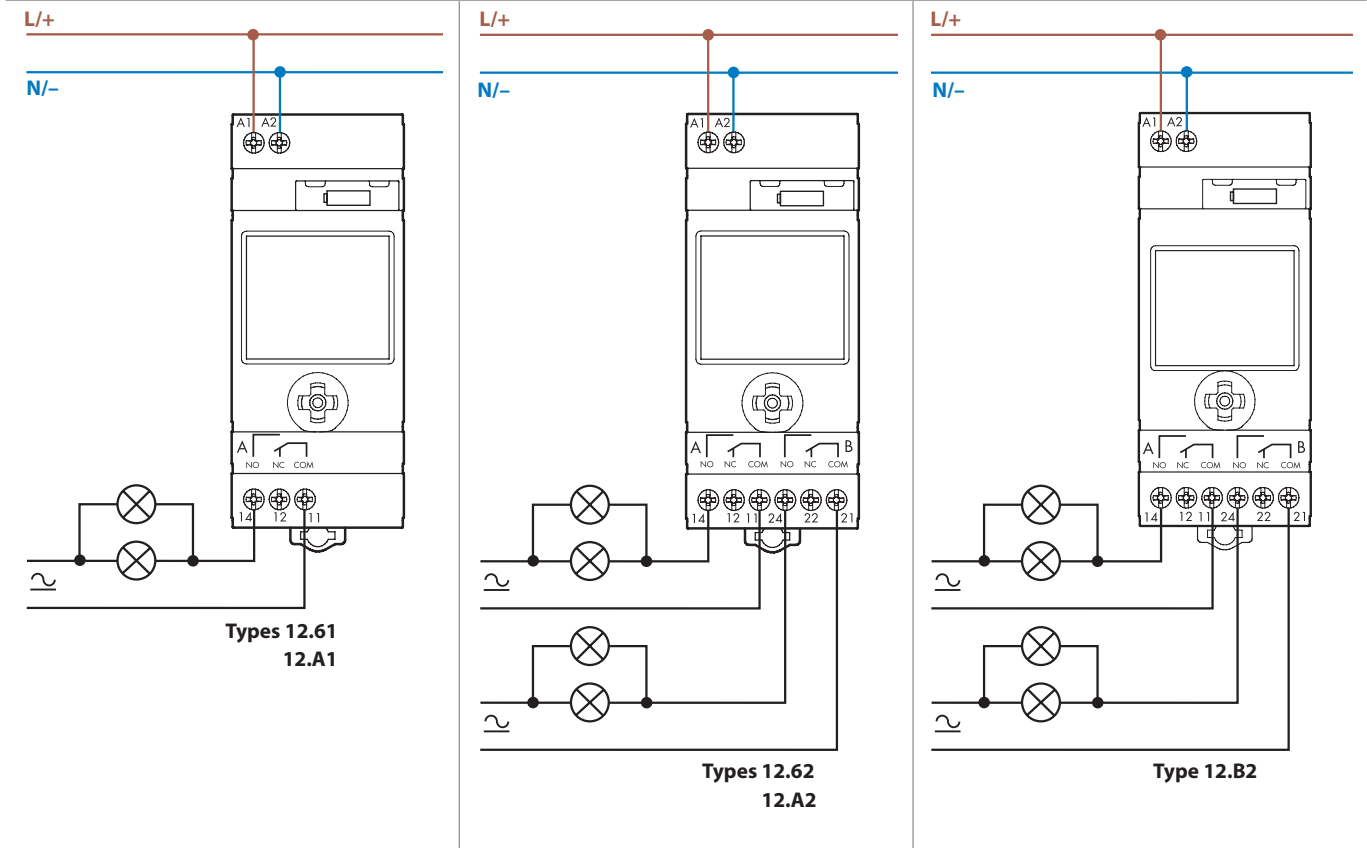

Wiring diagrams

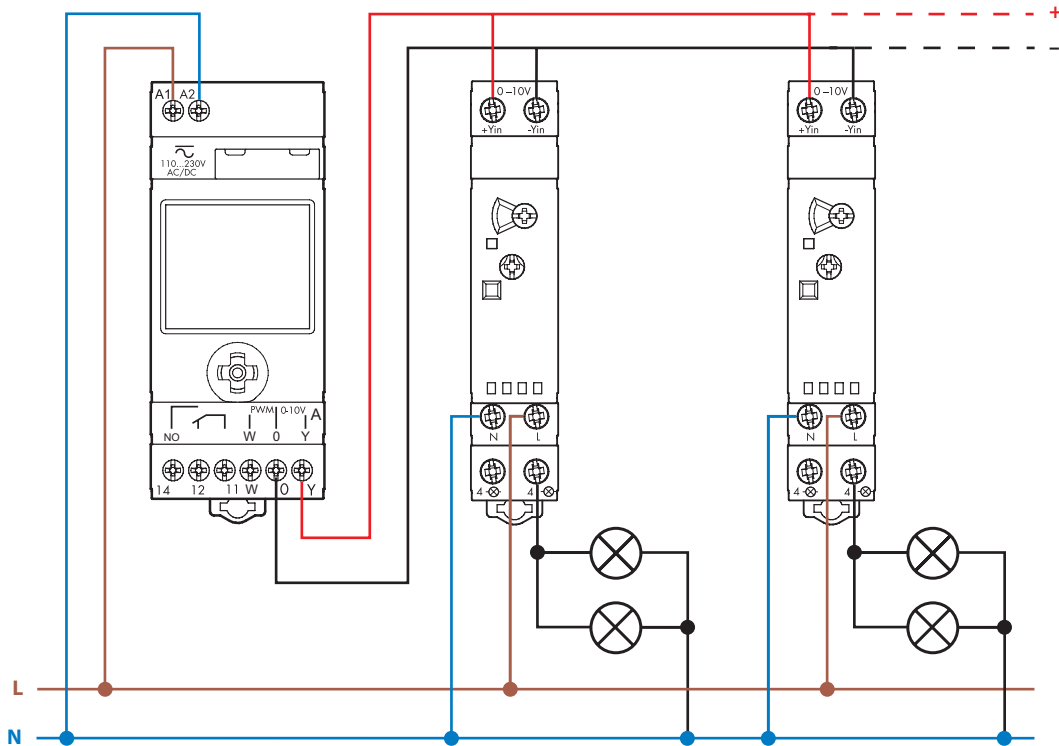

Type 12.A4 with 15.11
Application example with slave dimmer Type 15.11

Expandability

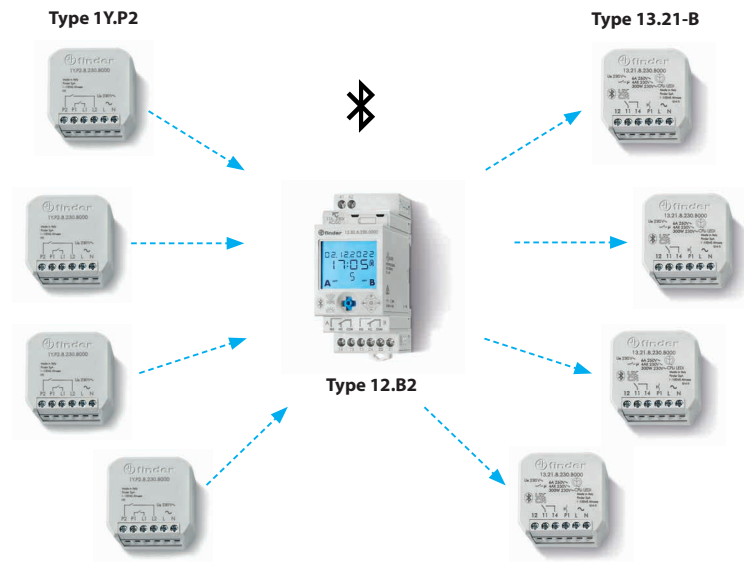

Using the maximum number of expansions, you can make up to 6 outputs and 8 inputs out of it



In this application you can use a range extender (Type 1Y.E8) to reach the most distant devices.

Different programming modes for type 12.51, 12.61, 12.62, 12.81, 12.A1, 12.A2, 12.A4, 12.B2

“Smart”

Mode via smartphones with NFC communication using Finder toolbox Android App.



“Classic”

Mode via the joystick

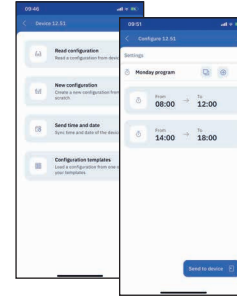
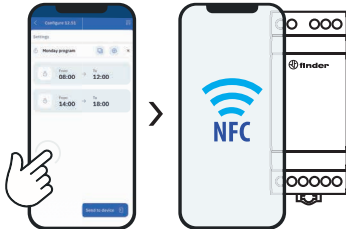

Bluetooth programming (Type 12.B2 only)

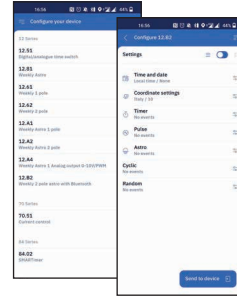
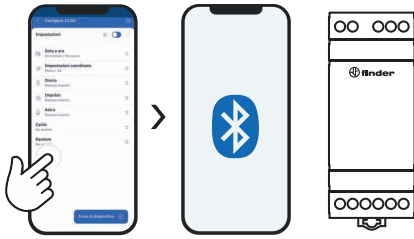

Finder Toolbox for programming

Once the App FINDER Toolbox is downloaded and installed, you can read an existing program, or program your device with maximum flexibility, changing the smallest details and saving your program directly to your smartphone.

At this point you simply touch the time switch with the smartphone to transfer the data.

Finder Toolbox for reference

Finder Toolbox provides all technical data sheets and news from Finder Toolbox.

J Functions type 12.81

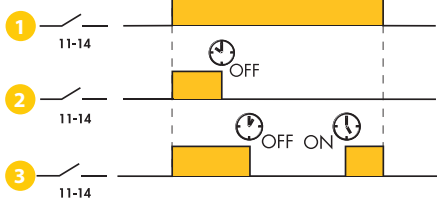
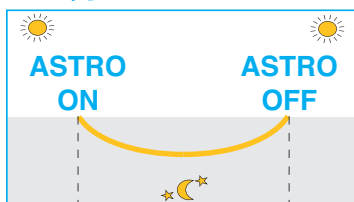

The Override feature permits the 12.81 three different ways of functioning:

- 1 Classic function where the **AstroON** and **AstroOFF** times are determined by the geographic coordinates. These times vary every day.
- 2 Functions such that the output turns on according to the **AstroON** time and turns off according to the clock off-time OFF. Application example: shop window lighting on by **AstroON** at sunset and off OFF at 00:30.
- 3 Functions such that the output turns on according to the **AstroON** time and turns off according to the clock off-time OFF, and then turns back on at the clock on-time ON (for the remainder of the ASTRO time period). Application example: company car park lighting, on by **AstroON** at sunset, off end of the evening shift at 23:00 OFF. On again at the beginning of the morning shift at 5:00 ON and off automatically by **AstroOFF***.

* Depending on the time of year (summer specifically) it may be that the override ON time will fall after the AstroOFF time. In this case, the output switches off at the AstroOFF time and the override ON time is ignored.

Outline drawings

Type 12.01
Screw terminal

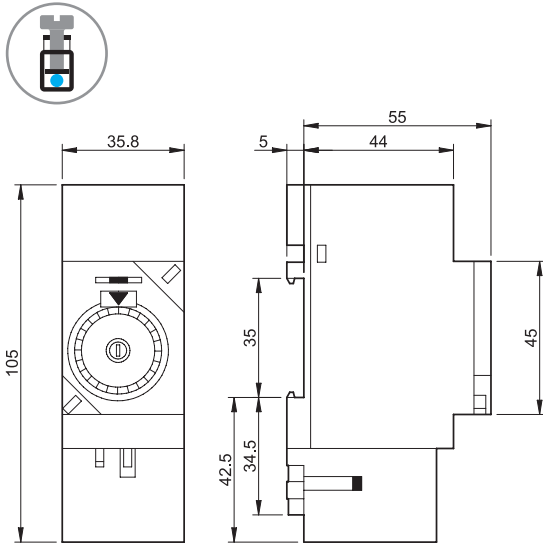

Type 12.11
Screw terminal

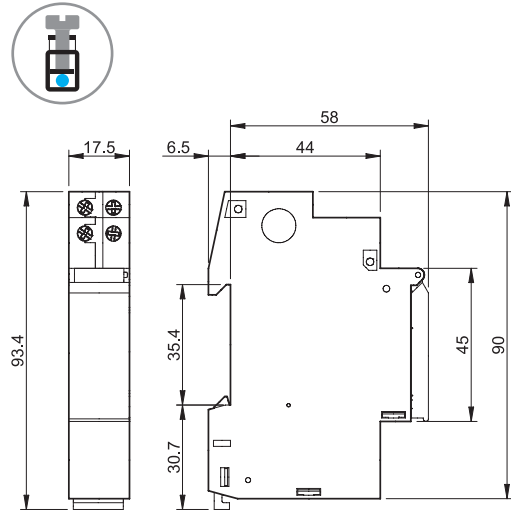

Type 12.31
Screw terminal

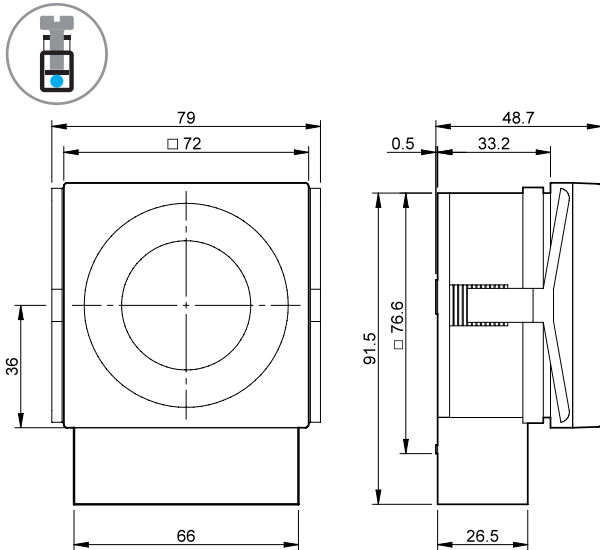

Types 12.51/12.81
Screw terminal

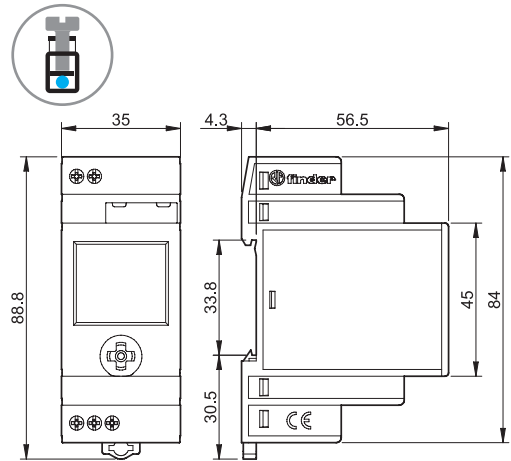

Type 12.71
Screw terminal

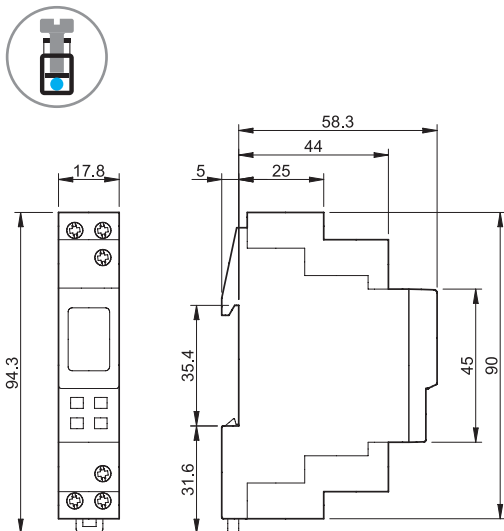

Types 12.61 / 12.A1
Screw terminal

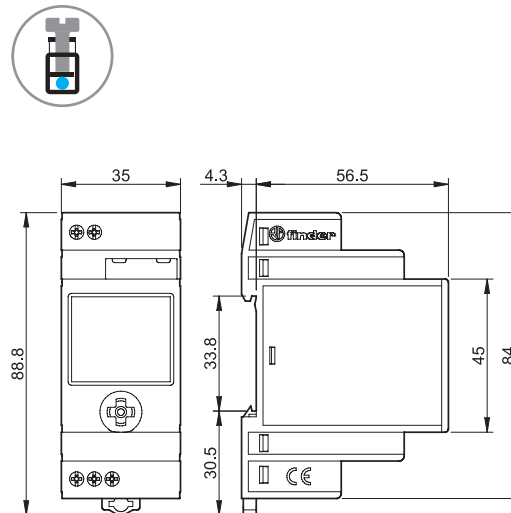

Outline drawings

Types 12.62 / 12.A2 / 12.A4
Screw terminal

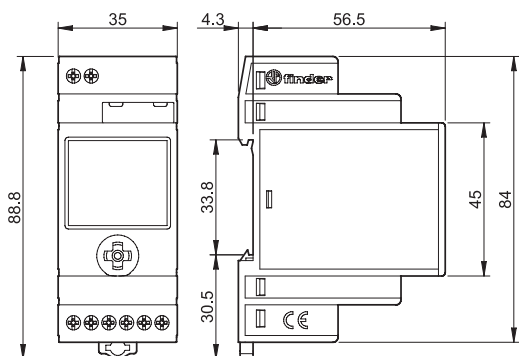

Type 12.B2
Screw terminal

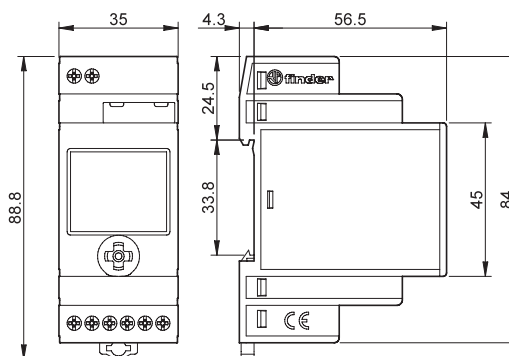

Battery replacement type 12.51, 12.61, 12.62, 12.81, 12.A1, 12.A2, 12.A4, 12.B2



Power-save mode

If the 230 V AC supply is not connected, the time switch enters power-save mode: only the clock is maintained active whilst the display turns off so as to guarantee a long life for the built-in back-up battery. With a press to the joystick it is possible to "awake" the device and enter Display mode (with the "plug" symbol displayed). A further press to  will enter the program or set-up mode as explained in the Display mode section above.

After about 1 minute of inactivity the power-save mode will start again. During program or set-up the current absorption is higher than in power-save mode, thus influencing the battery life.

In this mode the display back-light is not active. It is activated following a press to the joystick only with the 230 V AC supply connected, but after about 1 minute of inactivity the display back-light will turn off, and to activate it again it is necessary to press the joystick again.

Note: the output relay only functions if the power supply is connected.

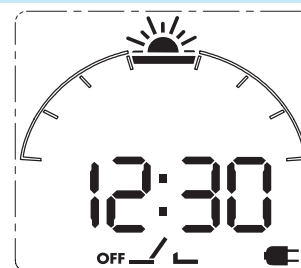

Accessories type 12.51, 12.61, 12.62, 12.81, 12.A1, 12.A2, 12.A4, 12.B2



011.01

Adaptor for panel mounting, 35 mm wide

011.01

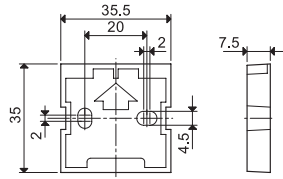

012.BG.8.230

GPS external antenna, this device synchronizes the 12.B2s time and date via Bluetooth

012.BG.8.230

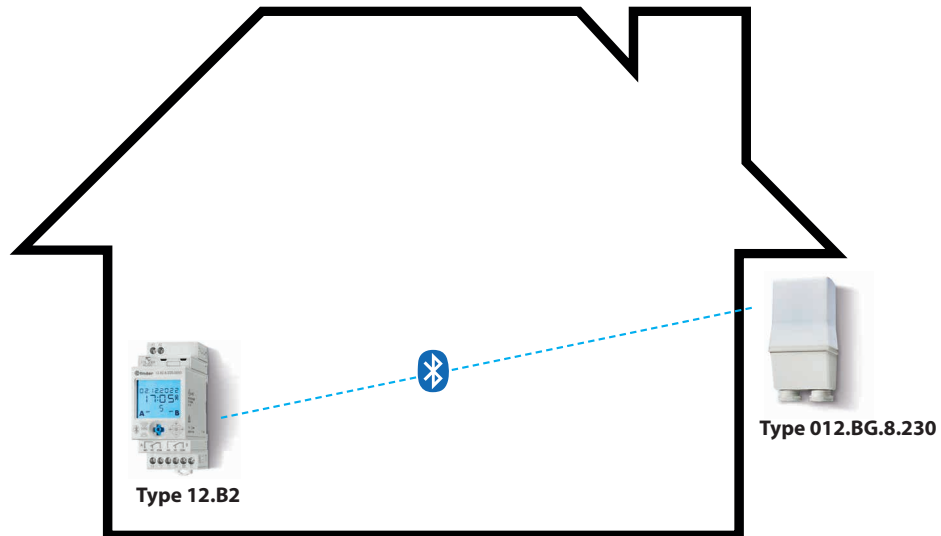
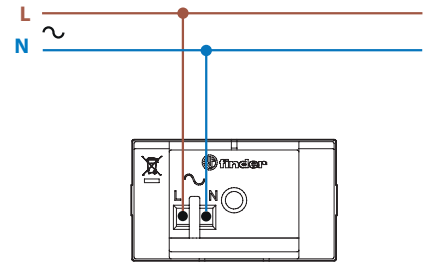
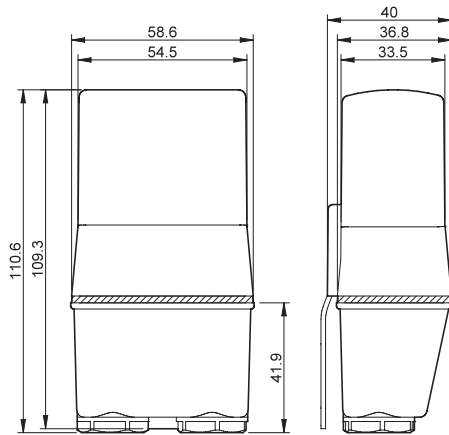

- The 12.B2 is designed to be installed in a cabinet, while the external antenna takes care of the constant time synchronization.
- There is no limit of 12.B2 for a single antenna, the only important parameter is the range of action of the Bluetooth.
- Install the antenna outside, close to a window or the external wall.

