

NT90T

NT90T



32.4×27.5×28.0

R50126373

Features

- Small size, light weight. Low coil power consumption, heavy contact load. Strong anti-shock and anti-vibration, high reliability, long life.
- Suitable for automobile, machine, electronic equipment, air conditioner and household appliances applications.
- PC board mounting and direct insert mounting available.

Ordering Information

NT90T H L A S DC12V C B 0.9

1 2 3 4 5 6 7 8 9

1 Part number: NT90T、NT90T ₂	6 Coil rated voltage(V) : AC:12,24,110,120,220 DC:3,5,6,9,12,15,18,24,48,110
2 Load: H:30A; N:40A	7 Contact material : C: AgCdO; S: AgSnO ₂
3 High: NIL: Standard; L: Low profile type	8 Resist heat class : B:130℃ F:155℃
4 Contact arrangement: A:1A; B:1B; C:1C	9 Coil power consumption : 0.6:0.6W; 0.9:0.9W NIL:2VA
5 Enclosure: S: Sealed type; D: Dust cover; E: Covered; O: Open type	

Contact Data

Contact Arrangement	1ASPSTBNO) 1B (SPSTNC) 1C (SPDT(B-M))	
Contact Material	AgCdO AgSnO ₂	
Contact Rating (resistive)	NO:30A/240VAC,14VDC; NC:20A/240VAC;30A/14VDC NO:40A/240VAC,30VDC; NC:30A/240VAC,30VDC (0.9W) NO:30A/277VAC;NC:20A/277VAC Motor load: NO:2HP 250VAC ; NC:1.5HP 250VAC Lamp load: TV-5 5A/280VAC(Ballast)	
Max. Switching Power	1100W 7200VA	
Max. Switching Voltage	110VDC 300VAC	Max. Switching Current:40A
Contact Resistance or Voltage drop	<30mΩ	Item 4.12 of IEC 61810-7
Operation Life	Electrical	10 ⁵ Item 4.30 of IEC 61810-7
	Mechanical	10 ⁷ Item 4.31 of IEC 61810-7

Coil Parameter

Dash numbers	Rated voltage VAC		Rated current mA	Coil resistance Ω ± 10%	Pick up voltage VAC(max) (75%of rated voltage)	Release voltage VAC(min) (30%of rated voltage)	Coil power	Operate Time ms	Release Time ms
	Rated	Max							
012AC	12	15.6	187	27	9.0	3.6	2VA	—	—
024AC	24	31.2	95	120	18.0	7.2			
110AC	110	143	20	2360	82.5	33.0			
120AC	120	156	16.5	3040	90.0	36.0			
220AC	220	286	6.4	13490	165.0	66.0			

- CAUTION:** 1.The use of any coil voltage less than the rated coil voltage will compromise the operation of the relay.
2.Pickup and release voltage are for test purposes only and are not to be used as design criteria.

Coil Parameter

DC Coil Parameter								
Dash numbers	Coil voltage V		Coil resistance Ω ± 10%	Pick up voltage VDC(max) (75% of rated voltage)	Release voltage VDC(min) (10% of rated voltage)	Coil power W	Operate Time ms	Release Time ms
	Rated	Max.						
003-900	3	3.9	10	2.25	0.3	0.9	<15	<10
005-900	5	6.5	28	3.75	0.5			
006-900	6	7.8	40	4.50	0.6			
009-900	9	11.7	90	6.75	0.9			
012-900	12	15.6	160	9.00	1.2			
015-900	15	19.5	250	10.25	1.5			
018-900	18	23.4	360	13.50	1.8			
024-900	24	31.2	640	18.00	2.4			
048-900	48	62.4	2560	36.00	4.8			
110-900	110	143	13445	82.50	11.0			
003-600	3	3.9	15	2.25	0.3	0.6	<15	<10
005-600	5	6.5	42	3.75	0.5			
006-600	6	7.8	60	4.50	0.6			
009-600	9	11.7	135	6.75	0.9			
012-600	12	15.6	240	9.00	1.2			
015-600	15	19.5	375	10.25	1.5			
018-600	18	23.4	540	13.50	1.8			
024-600	24	31.2	960	18.00	2.4			
048-600	48	62.4	3840	36.00	4.8			
110-600	110	143	20167	82.50	11.0			

- CAUTION:** 1.The use of any coil voltage less than the rated coil voltage will compromise the operation of the relay.
2.Pickup and release voltage are for test purposes only and are not to be used as design criteria.

Operation condition

Insulation Resistance	1000MΩ min (at 500VDC)	Item 7 of IEC 60255-5
Dielectric Strength		
Between contacts	50Hz 1500V	Item 6 of IEC 60255-5
Between contact and coil	50Hz 2500V	Item 6 of IEC 60255-5
Shock resistance	200m/s ² 11ms	IEC 68-2-27 Test Ea
Vibration resistance	10~55Hz double amplitude 1.5mm	IEC 68-2-6 Test Fc
Terminals strength	10N	IEC 68-2-21 Test Ua1&Ua2
Solderability	235℃ ± 2℃ 3 ± 0.5s	IEC 68-2-20 Test Ta method 1
Ambient Temperature	-55~100℃ -55~125℃	
Relative Humidity	85% (at 40℃)	IEC 68-2-3 Test Ca
Mass	31g (Low profile type) 35g	

NT90T

Dimensions

mm /inch

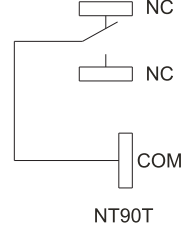
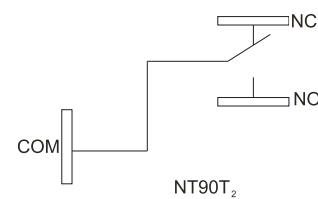
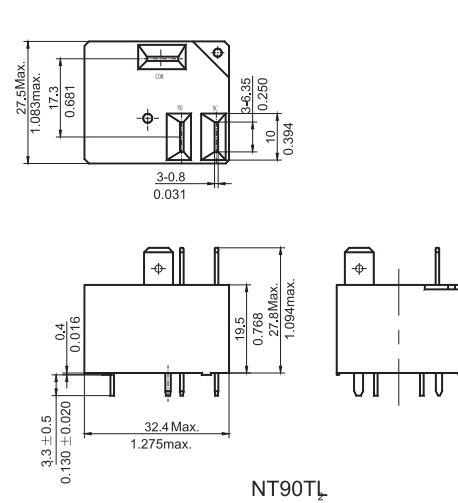
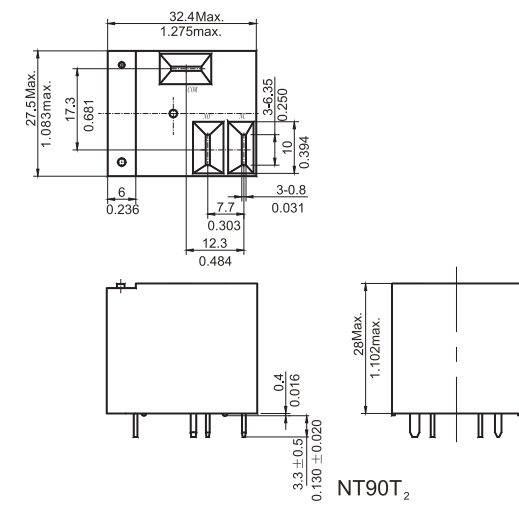
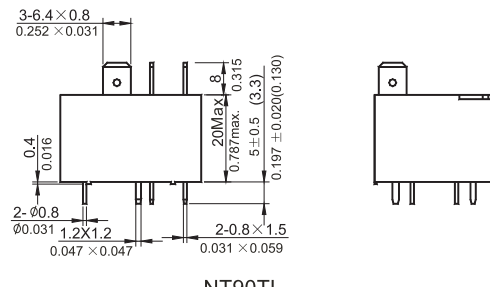
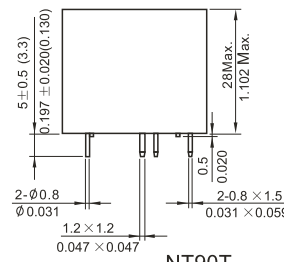
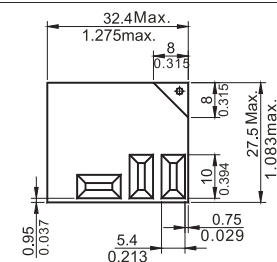
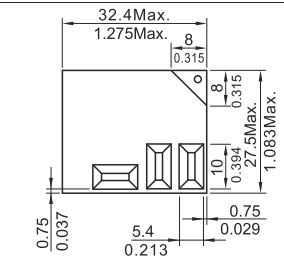

Wiring diagram(Top view)

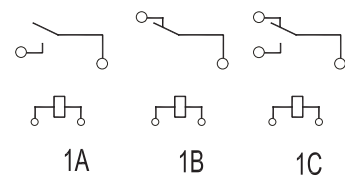

Wiring diagram(Bottom view)

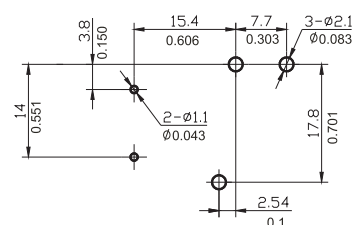

Mounting (Bottom view)

Safety approvals

Safety approval	UL&CUR	TuV	CQC
Load	NO:40A/240VAC 30A/277VAC NC: 30A/240V AC,30VDC 20A/277V AC Ballast:5A/280VAC TV-5 HP:A 2 HP 250VAC 1HP/16AFLA/120VAC 2HP/12AFLA/240VAC B 1½ HP 250VAC 30LRA/10AFLA/120VAC 30LRA/10AFLA/240VAC InsulationB-class F-class	NO:40A/240VAC 14VDC 30A/277VAC NC:30A/240VAC 14VDC 20A/277VAC Insulation : B-class F-class	NO:30A/240VAC NC:20A/240VAC

Reference Data

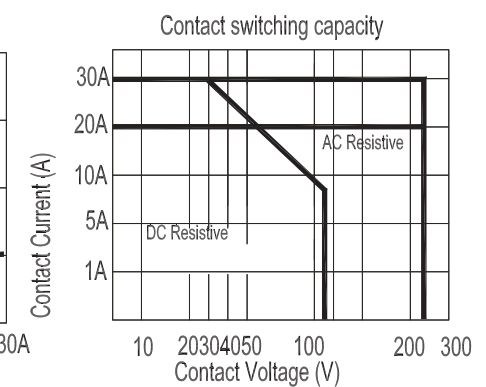
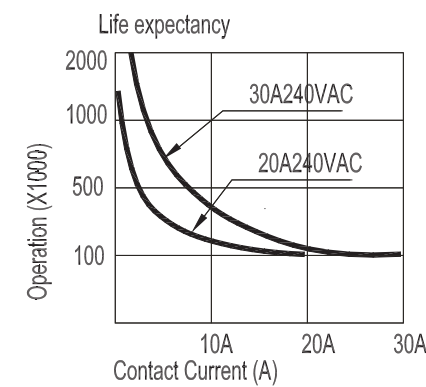
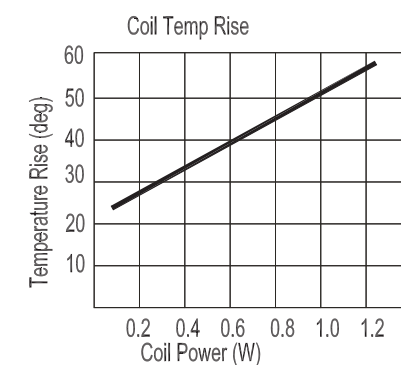
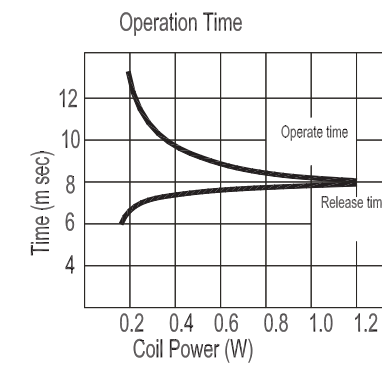

NOTES 1).Dimensions are in millimeters.
2).Inch equivalents are given for general information only.