

Pyroelectric Infrared Sensors



for EU RoHS Compliant

- All the products on this catalog are complied with EU RoHS.
- EU RoHS is "the European Directive 2002/95/EC on the Restriction of the Use of Certain Hazardous Substances in Electrical and Electronic Equipment".
- For more details, please refer to our website 'Murata's Approach for EU RoHS' (<http://www.murata.com/info/rohs.html>).

CONTENTS

HIC® in this catalog are the trademarks of
Murata Manufacturing Co., Ltd.

Part Numbering	2
1 SMD-Dual / Parallel Quad Type Pyroelectric Infrared Sensor IRS Series	3
2 Dual Type Pyroelectric Infrared Sensor IRA-E700 Series	5
3 Quad Type Pyroelectric Infrared Sensor IRA-E900 Series	6
Pyroelectric Infrared Sensor IRS/IRA Series Characteristics Data	7
Lens	10
Notice	18

1

2

3

● Part Numbering

Pyroelectric Infrared Sensor

(Part Number)

IR	S-	B210ST	01	-R1
①	②	③	④	⑤

- ① Product ID
- ② Type
- ③ Characteristics
- ④ Individual Specification Code

* Part Number shows only an example which might be different from actual part number.

* "③ Characteristics" and "④ Individual Specification Code" might have different digit number from actual Part Number.

Pyroelectric Infrared Sensors for Reflow Soldering



SMD-Dual Type Pyroelectric Infrared Sensor IRS-B210ST01 Series

SMD type Pyroelectric infrared sensors, IRS series, exhibit high sensitivity and reliable performance made possible by Murata's ceramic technology and packaging technology developed over many years.

IRS-B series is approximately 50% smaller in volume and 10% thinner than our previous surface mount model.

Compared with common lead-type models, it is significantly smaller with a lower profile approximately 20% less in volume and 50% less in thickness than the former.

■ Features

1. Reflow surface-mounting support
2. Smallest and ultra-thin throughout the trade (4.7×4.7×2.4mm)
3. High sensitivity
4. Achieves superior electromagnetic noise resistance characteristics

■ Applications

1. Human detection
2. TV
3. Air conditioning
4. Digital photo-frame
5. Personal computers
6. Automatic switches for lighting equipment
7. WEB cameras (IP cameras)
8. Automatic warm water cleaning toilet seats
9. Security devices
10. Other automatic switches
(ex. LCD monitors, Air purifiers, Ventilation fans)
11. Home electronics for Eco

■ Rating (25°C)

Part Number	IRS-B210ST01
Responsivity (500K, 1Hz, 1Hz)	3.6mV _{p-p} (Typ.)
Field of View	θ1=70° θ2=50°
Optical Filter	3μm long-pass
Electrode	-
Supply Voltage	2 to 15V
Operating Temperature	-40 to 70°C
Storage Temperature	-40 to 85°C

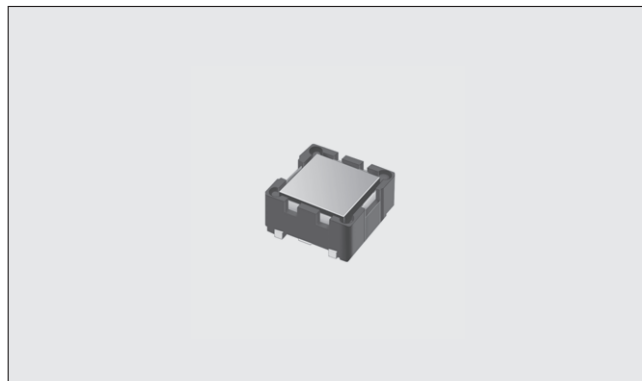

■ Dimensions & Circuit Diagrams

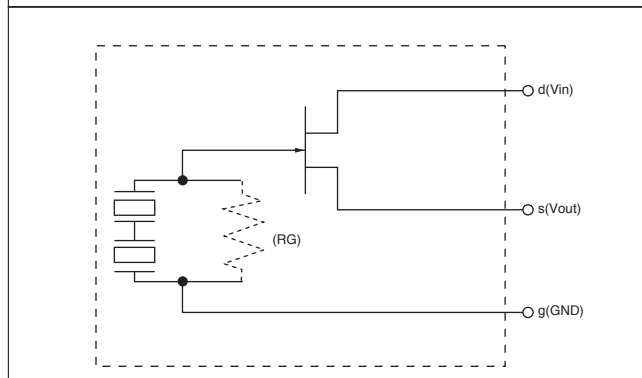
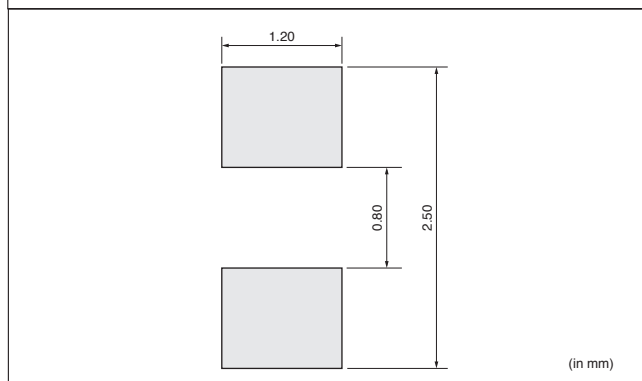
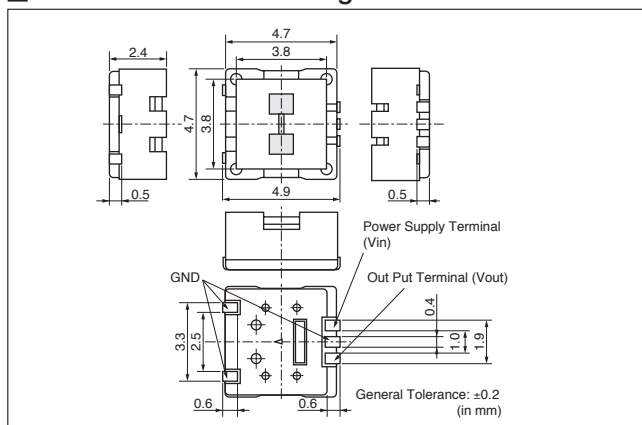

Pyroelectric Infrared Sensors



Dual Type Pyroelectric Infrared Sensor IRA-E700 Series

Pyroelectric infrared sensors, IRA series, exhibit high sensitivity and reliable performance made possible by Murata's ceramic technology and Hybrid IC technique expertise developed over many years.

IRA-E700 series realizes cost benefits and higher performance with a new infrared sensor element of improved material parameters and fabrication.

IRA-E700 series is available in two types.

IRA-E710ST0 has enhanced immunity to RFI (Radio Frequency Interference).

■ Features

1. High sensitivity and excellent S/N ratio
2. High stability to temperature changes
3. Slight movement can be detectable.
4. High immunity to external noise (Vibration, RFI etc.)
5. Custom design is available.
6. Higher in cost-performance

■ Applications

1. Security
2. Lighting appliances
3. Household or other appliances

■ Rating (25°C)

Part Number	IRA-E700ST0	IRA-E710ST0
Responsivity (500K, 1Hz, 1Hz)	4.3mV _{p-p} (Typ.)	
Field of View	$\theta_1=\theta_2=45^\circ$	
Optical Filter	5 μ m long-pass	
Electrode	(2.0×1.0mm)×2	
Supply Voltage	2 to 15V	
Operating Temperature	-40 to 70°C	
Storage Temperature	-40 to 85°C	

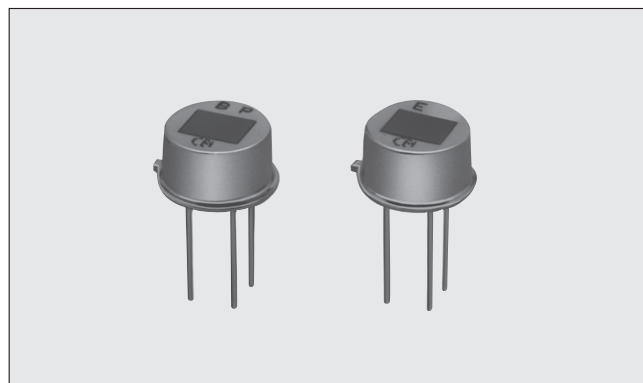

■ Dimensions & Circuit Diagrams

Technical drawings showing dimensions and circuit diagrams for the IRA-E700 series sensors.

Dimensions (in mm):

- Top view: 4.7±0.1 (width), 3.7±0.1 (height), 9.2 (total height)
- Side view: 4.7 (total height), 3.6 (height to top of stem), 11.0±0.2 (total length), 0.45±0.05 (stem diameter)
- Bottom view: 5.0±0.05 (width), 1.0 (width of each stem)

Field of View: 45°

*Specified on the bottom of stem

General Tolerance : ±0.2 (in mm)

Pyroelectric element dimensions (in mm): 2.0 (height), 1.0 (width of each element)

Circuit Diagrams:

- IRA-E700ST0: Shows a pyroelectric element connected to a bridge circuit with a resistor (RG) and a capacitor. Terminals are labeled d, s, and g.
- IRA-E710ST0: Shows a similar circuit but with an additional diode connected to the bridge circuit.

Pyroelectric Infrared Sensors



Quad Type Pyroelectric Infrared Sensor IRA-E900 Series

3

Pyroelectric infrared sensors, IRA series, exhibit high sensitivity and reliable performance made possible by Murata's ceramic technology and Hybrid IC technique expertise developed over many years.

IRA-E900 series realizes cost benefits and higher performance with a new infrared sensor element of improved material parameters and fabrication.

IRA-E900 series is available in two types.

IRA-E910ST1 has enhanced immunity to RFI (Radio Frequency Interference).

■ Features

1. High sensitivity and excellent S/N ratio
2. High stability to temperature changes
3. Slight movement can be detectable.
4. Non directional sensing with wide F.O.V.
5. High immunity to external noise (Vibration, RFI etc.)
6. Custom design is available.
7. Higher in cost-performance

■ Applications

1. Security
2. Lighting appliances
3. Household or other appliances

■ Rating (25°C)

Part Number	IRA-E900ST1	IRA-E910ST1
Responsivity (500K, 1Hz, 1Hz)	3.3mV _{p-p} (Typ.)	
Field of View	$\theta_1=\theta_2=41^\circ$	
Optical Filter	5 μ m long-pass	
Electrode	(1.1×1.1mm)×4	
Supply Voltage	3 to 15V	
Operating Temperature	-25 to 55°C	
Storage Temperature	-40 to 85°C	

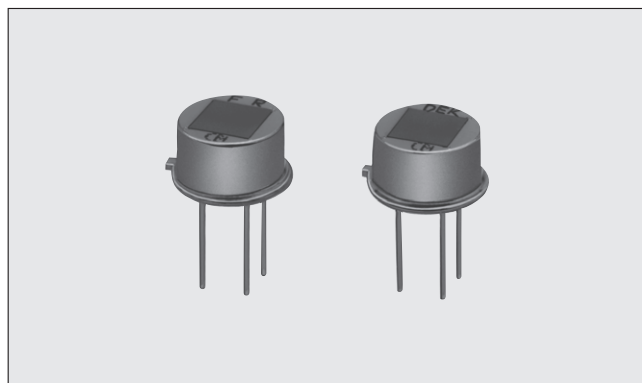

■ Dimensions & Circuit Diagrams

General Tolerance : ±0.2 (in mm)

(in mm)

IRA-E900ST1

IRA-E910ST1

Pyroelectric Infrared Sensor IRS/IRA Series Characteristics Data

■ Spectral Response of Window Materials (IRS Series)

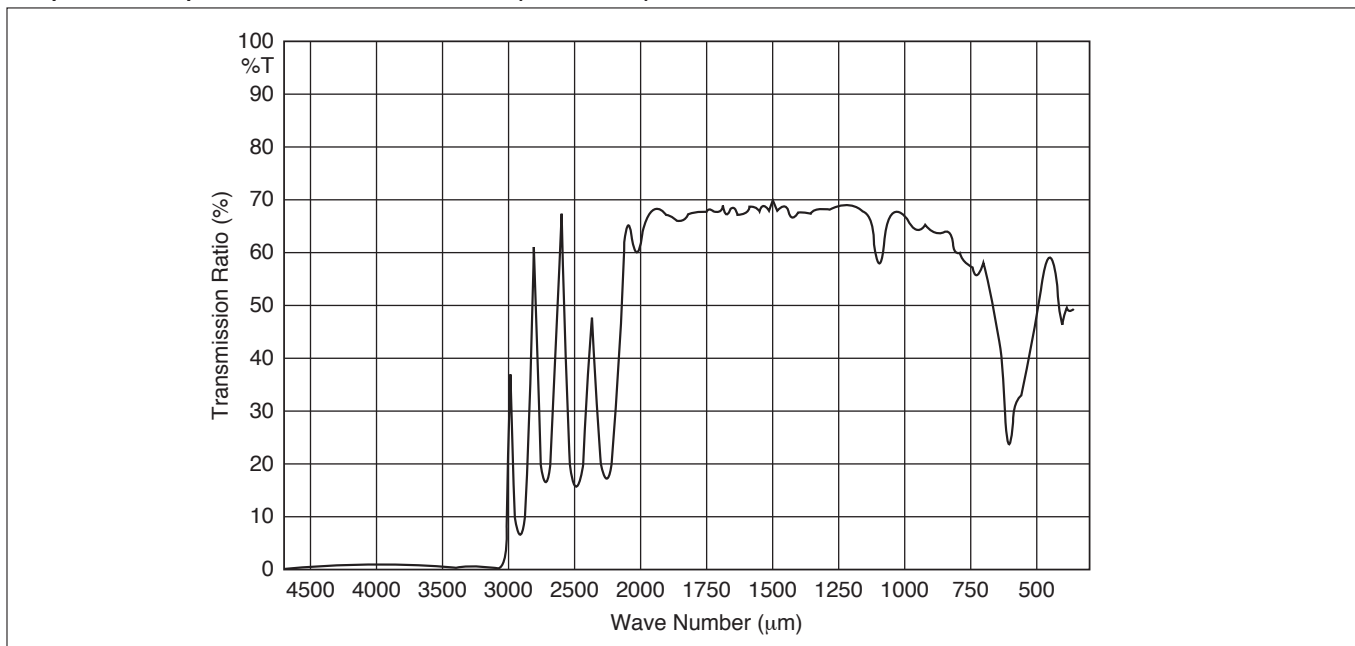

■ Spectral Response of Window Materials (IRA Series)

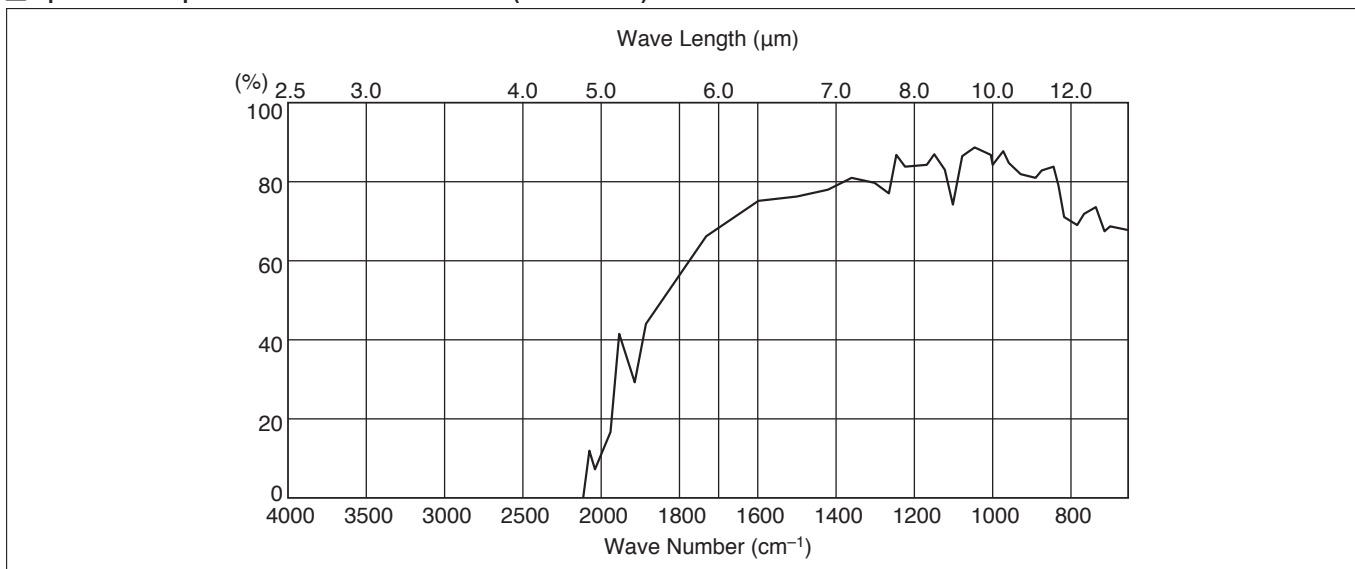

■ Frequency Characteristics

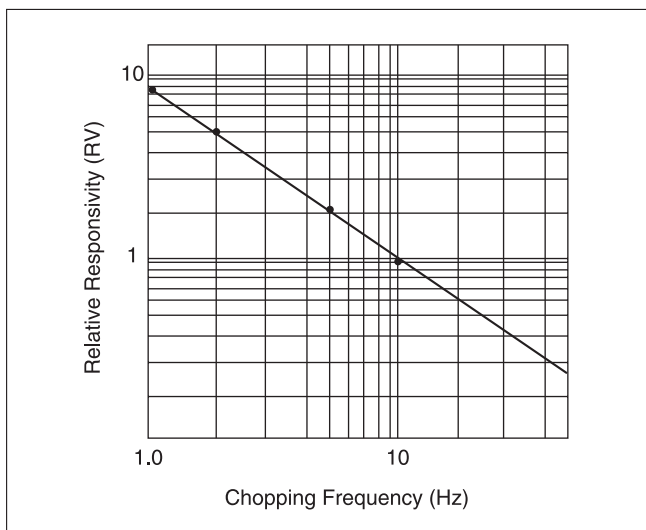

Pyroelectric Infrared Sensor IRS/IRA Series Characteristics Data

■ Reliability Test

IRS series, IRA-E700 series, IRA-E900 series

Item	Test Conditions	Criteria
High Temperature	100°C for 500 hrs.	After test completion, leave for three hours in normal humidity temperature conditions, and then measure. 1. External appearance: No significant damage 2. Sensitivity: Tolerance within 20% deviation from original value 3. Noise: Maximum tolerance +100mV of original value
Low Temperature	-40°C for 500 hrs.	
Humidity	60°C, 95% RH for 500 hrs.	
Heat Cycle	20 times of following cycle. -25°C, 30 min. ⇄ Room temp., 30 min. ↓ ↑ Room temp., 30 min. ⇄ 55°C, 30 min.	
Vibration	Apply vibration of amplitude of 1.5mm with 10 to 55Hz band to each of 3 perpendicular directions for 60 min.	
Shock	Apply shock of 100G sine wave by standard shock tester to each of 3 perpendicular directions.	
Soldering Heat	Immerse up to 3.0mm from can case in solder bath of 260±5°C for 10±1 s.	
Hermetic Sealing	Conform to MIL-STD-202F chapter 112D, condition D. Immerse in fluorocarbon bath (FC-40) of 125±5°C for 20 s.	No generation of bubbles

Pyroelectric Infrared Sensors/Lens(IRS Series)



IML-0650

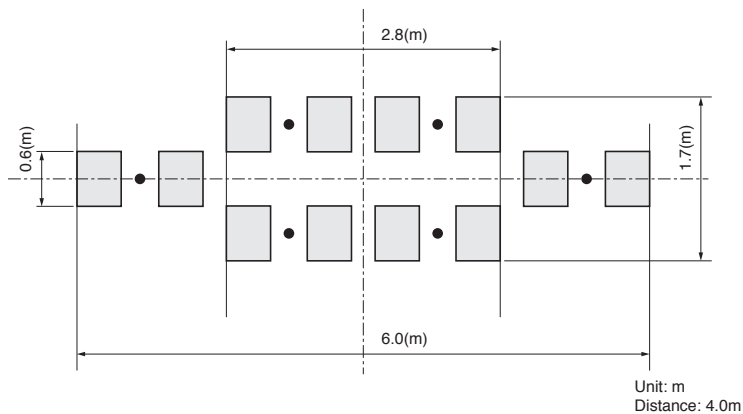
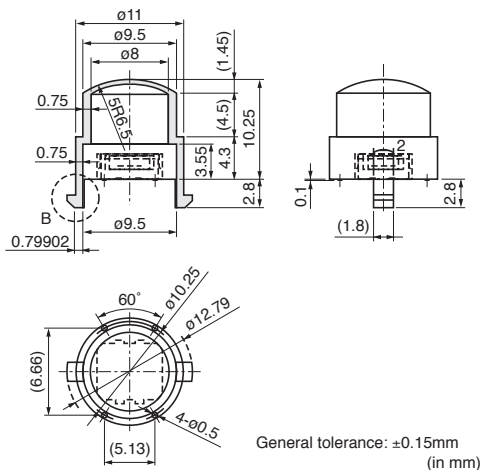

Sensor : IRS-B210ST01

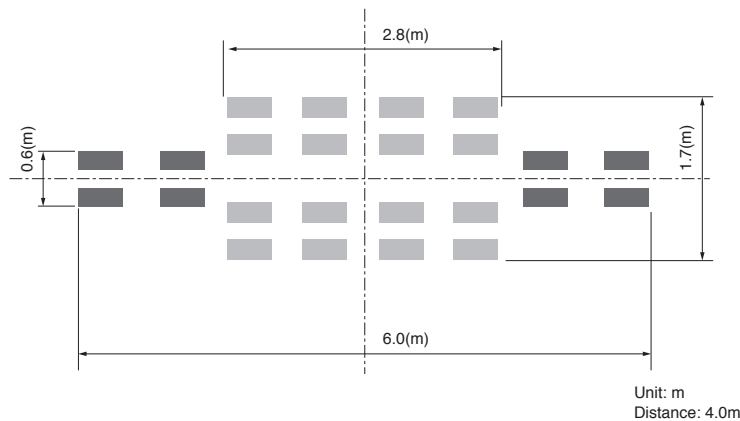

Sensor : IRS-B340ST02

Pyroelectric Infrared Sensors/Lens(IRS Series)



IML-0654

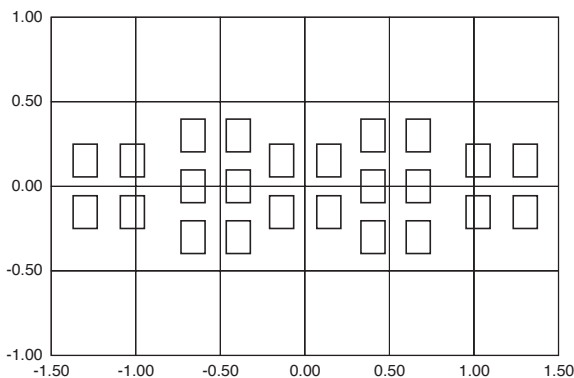
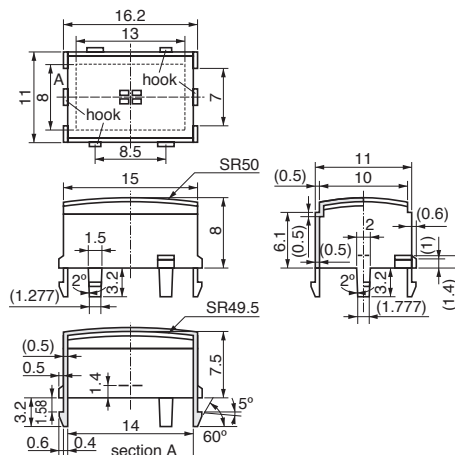

Unit: m
 Distance: 1.0m

Sensor : IRS-B210ST01

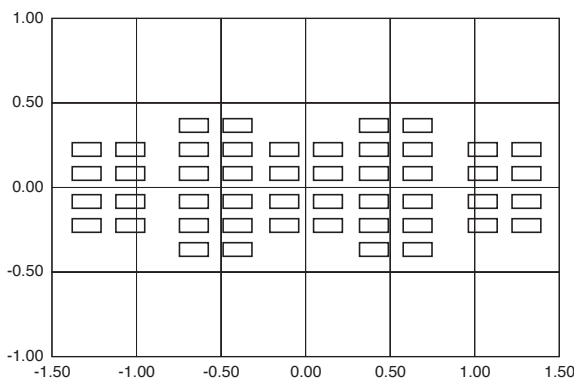

Unit: m
 Distance: 1.0m

Sensor : IRS-B340ST02

Pyroelectric Infrared Sensors/Lens(IRA Series)



IML-0669

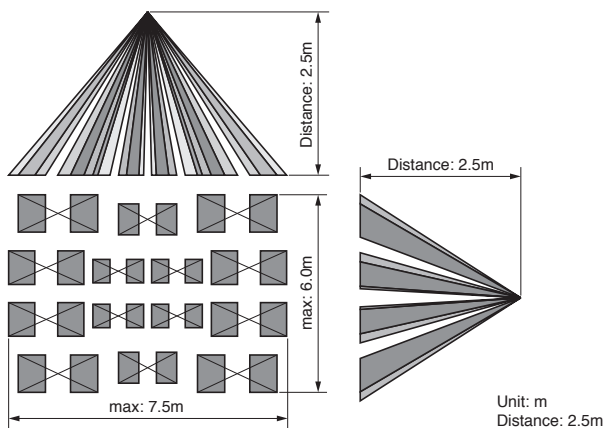
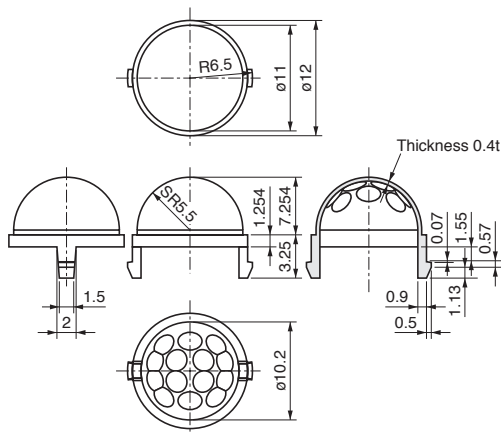

Sensor : IRS-B210ST01

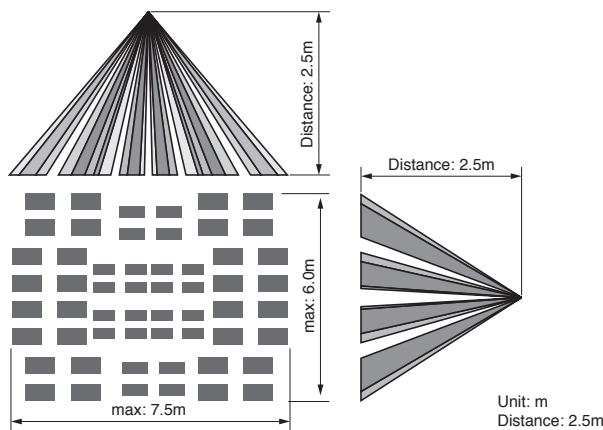

Sensor : IRS-B340ST02

Pyroelectric Infrared Sensors/Lens(IRA Series)



IML-0635

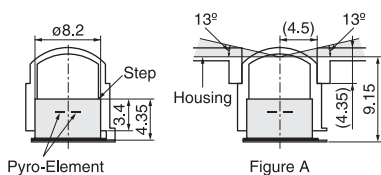
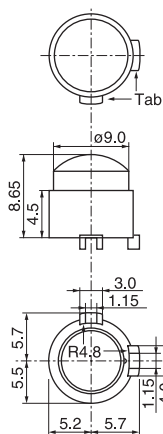

- 1) Insert a sensor into Fresnel lens like each tab is overlapped. (In case there are two tabs on Fresnel lens, the field of view is determined by your choice (TabA or B on Fresnel lens). Please see following page(s) for more details to see which characteristic of field of view is preferable for your application.)
- 2) Push the sensor into Fresnel lens until the top face of sensor reaches to the stopper inside Fresnel lens.
- 3) Please prepare a housing yourself that is put onto Fresnel lens as shown in FigureA. The hatching area shown in Figure A, must be obscured by the housing in order to prevent mis-detection. Unless otherwise unexpected infrared ray comes though the hatching area.

(in mm)
 General tolerance : ±0.2

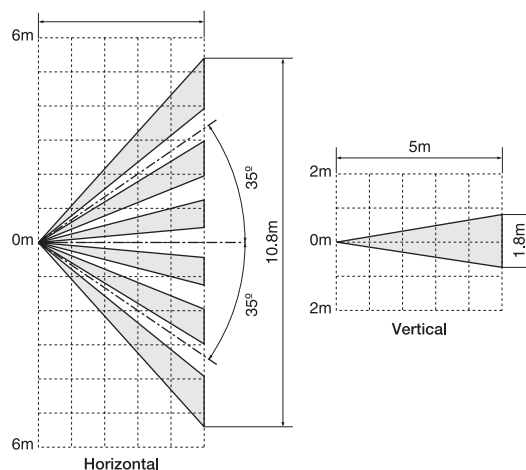

*Assembled with Murata sensor IRA-E700 series

IML-0636

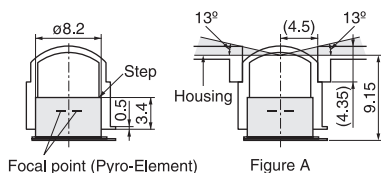
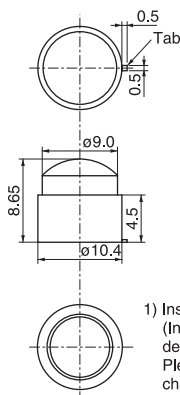

- 1) Insert a sensor into Fresnel lens like each tab is overlapped. (In case there are two tabs on Fresnel lens, the field of view is determined by your choice (TabA or B on Fresnel lens). Please see following page(s) for more details to see which characteristic of field of view is preferable for your application.)
- 2) Push the sensor into Fresnel lens until the top face of sensor reaches to the stopper inside Fresnel lens.
- 3) Please prepare a housing yourself that is put onto Fresnel lens as shown in FigureA. The hatching area shown in Figure A, must be obscured by the housing in order to prevent mis-detection. Unless otherwise unexpected infrared ray comes though the hatching area.

(in mm)
 General tolerance : ±0.2

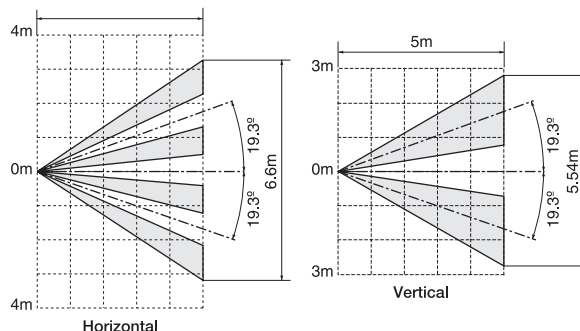

*Assembled with Murata sensor IRA-E700 series

Pyroelectric Infrared Sensors/Lens(IRA Series)



IML-0637

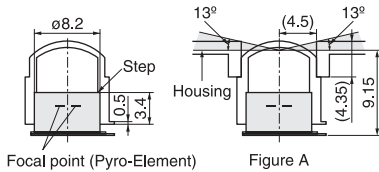
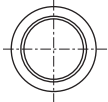
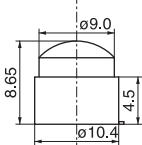
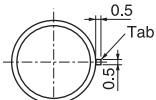

Focal point (Pyro-Element)

Figure A

- 1) Insert a sensor into Fresnel lens like each tab is overlapped. (In case there are two tabs on Fresnel lens, the field of view is determined by your choice (TabA or B on Fresnel lens). Please see following page(s) for more details to see which characteristic of field of view is preferable for your application.)
- 2) Push the sensor into Fresnel lens until the top face of sensor reaches to the stopper inside Fresnel lens.
- 3) Please prepare a housing yourself that is put onto Fresnel lens as shown in FigureA. The hatching area shown in Figure A, must be obscured by the housing in order to prevent mis-detection. Unless otherwise unexpected infrared ray comes though the hatching area.

(in mm)

General tolerance : ±0.2

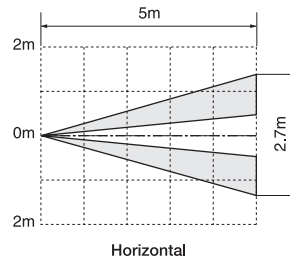

Horizontal

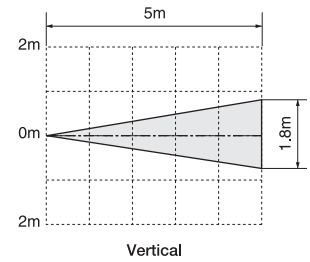

Vertical

*Assembled with Murata sensor IRA-E700 series

IML-0638

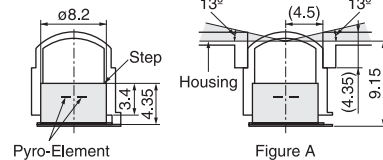
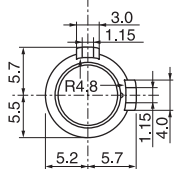
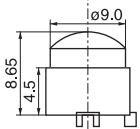
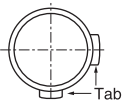

Pyro-Element

Figure A

- 1) Insert a sensor into Fresnel lens like each tab is overlapped. (In case there are two tabs on Fresnel lens, the field of view is determined by your choice (TabA or B on Fresnel lens). Please see following page(s) for more details to see which characteristic of field of view is preferable for your application.)
- 2) Push the sensor into Fresnel lens until the top face of sensor reaches to the stopper inside Fresnel lens.
- 3) Please prepare a housing yourself that is put onto Fresnel lens as shown in FigureA. The hatching area shown in Figure A, must be obscured by the housing in order to prevent mis-detection. Unless otherwise unexpected infrared ray comes though the hatching area.

(in mm)

General tolerance : ±0.2

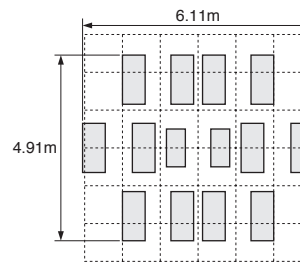

On the Floor

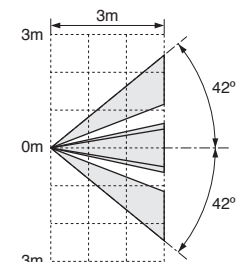

Vertical

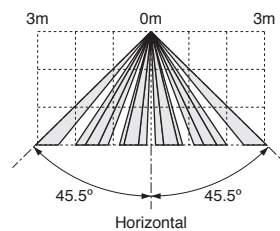

Horizontal

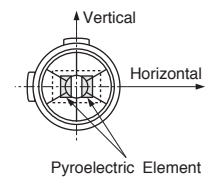

Pyroelectric Element

Assembled with Murata sensor IRA-E700 Series.

Pyroelectric Infrared Sensors/Lens(IRS/IRA Series)



PPGI0601

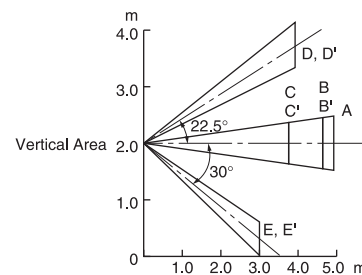
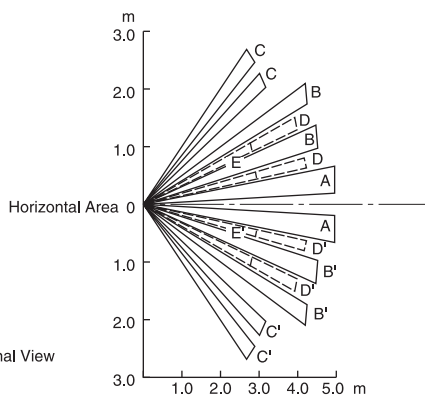
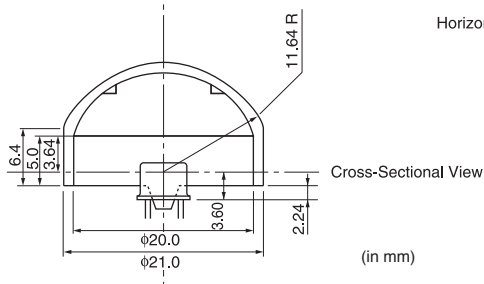
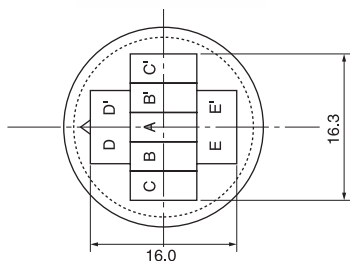

PPGI0626

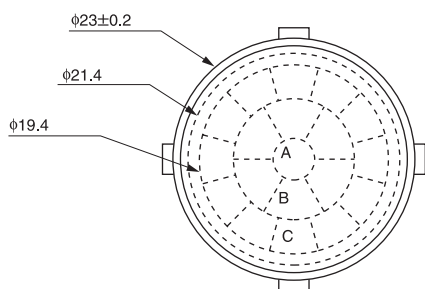
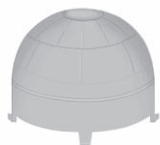

Detection area on the floor

B : 60° pitch
 C : 30° pitch

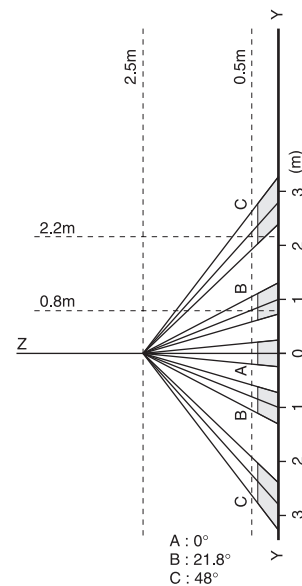
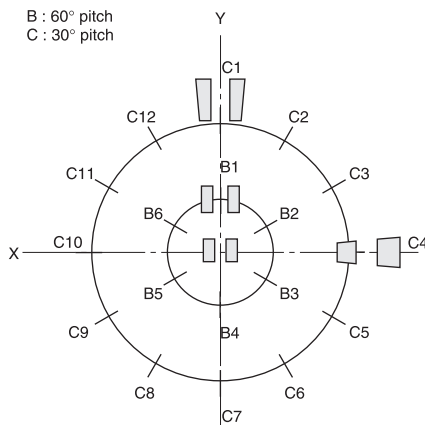
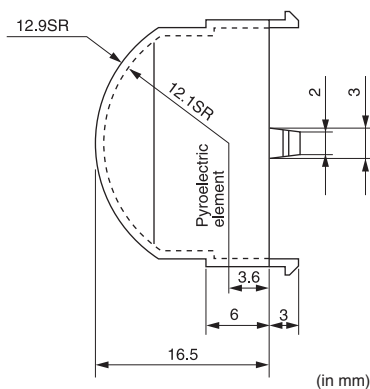

Pyroelectric Infrared Sensors/Lens(IRS/IRA Series)



PPGI0902

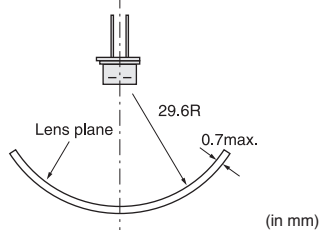
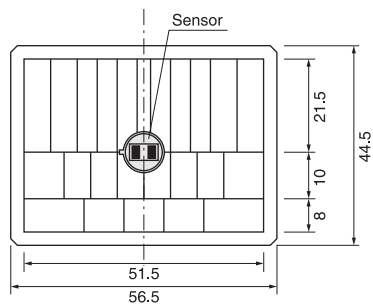
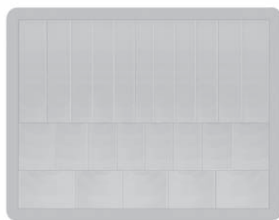

Horizontal Area

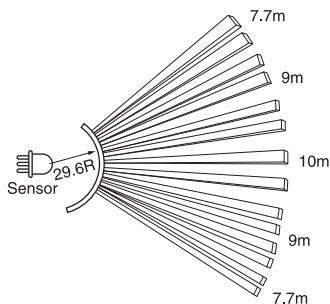

Vertical Area

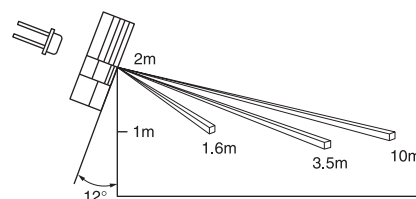

Pyroelectric Infrared Sensors/Lens(IRA Series)



IMD-FL01G

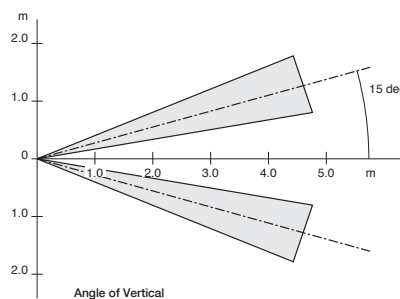
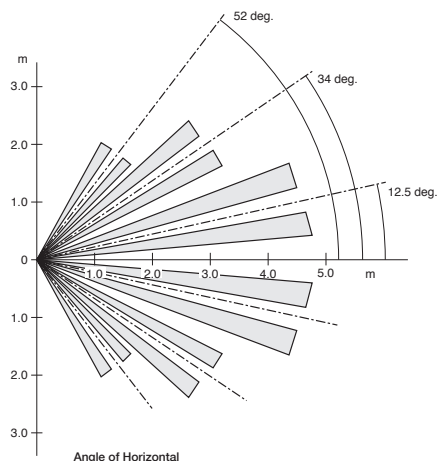
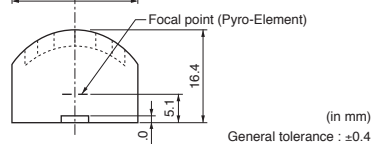
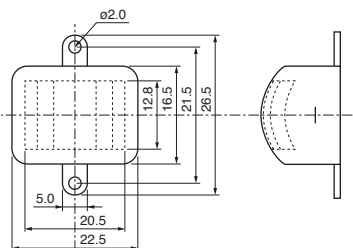

IMD-FL01W

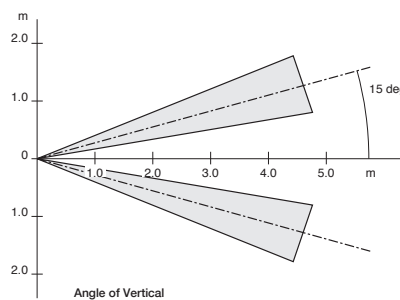
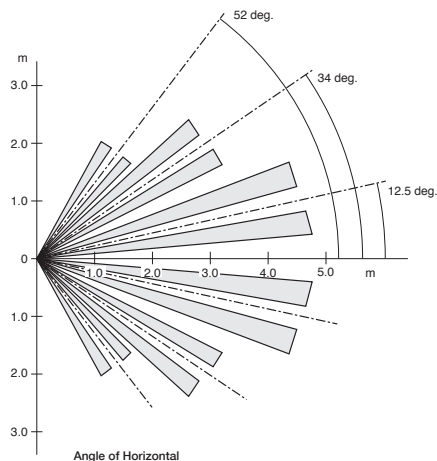
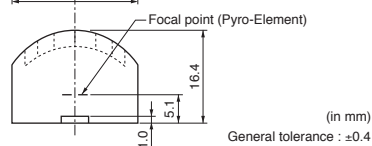
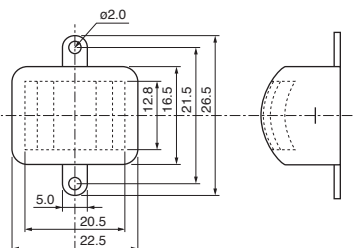

Fresnel lens are available upon request.

Notice

■ Notice

1. Caution (Design)

- (1) Please make sure that your product has been evaluated and confirmed against your specifications when our product is mounted to your product.
- (2) Be sure to provide an appropriate fail-safe function on your product to prevent a second damage that may be caused by the abnormal function or the failure of our product.
- (3) In case of outdoor use, suitable optical filter and water and humidity proof structure should be applied.
- (4) To prevent failure or malfunction, please use a stabilized power supply.
- (5) Please avoid using the sensor in the following conditions because it may cause failure or malfunction.
 - (a) in such a fluid as water, alcohol etc. corrosive gas (SO₂, Cl₂, NO_x etc.) or sea breeze
 - (b) in high humidity
 - (c) in a place exposed directly to sunlight or headlights of automobile
 - (d) in a place exposed to rapid ambient temperature change
 - (e) in a place exposed directly to an air-conditioner or heat vent
 - (f) strong vibrations
 - (g) in a place exposed to strong electromagnetic field
 - (h) in such a place where infrared ray is shaded
 - (i) in any other place similar to the above (a) through (h)

2. Caution (Handling and Storage)

- (1) The optical filter of the sensor should not be scratched or soiled.
- (2) Strong shock should be avoided.
- (3) Electrostatics and strong electromagnetic field should be avoided.
- (4) The sensor should be kept on conductive sponge.
- (5) High temperature, high humidity, fluid such as water or alcohol etc., corrosive gas (SO₂, Cl₂, NO_x etc.) and sea breeze should be avoided.

Notice

■ Notice

3.Caution (Mounting)

(IRS Series)

Soldering Conditions

Following figure shows temperature profile when reflow soldering.

- Cleaning after reflow soldering should not be applied.
- Flow soldering should not be applied.
- Please contact us when using other reflow profile except following reflow profile.

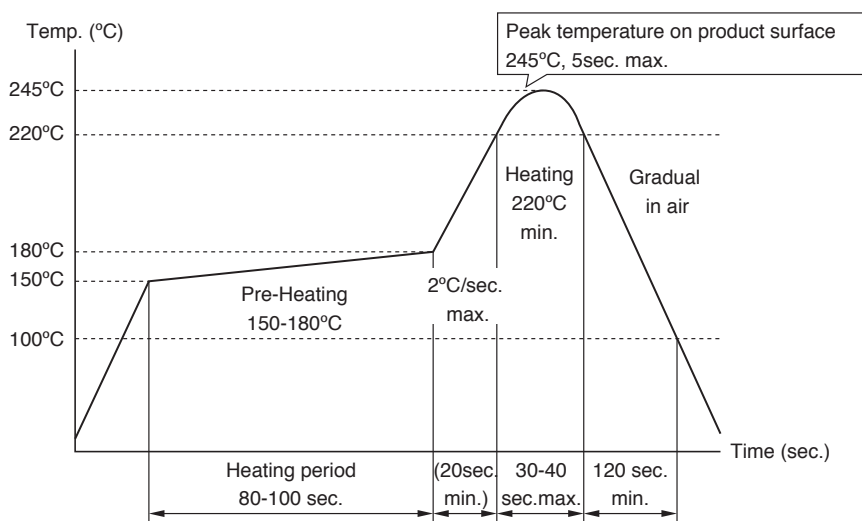

- (1) Cleaning after reflow soldering should not be applied.
 Optical filter of sensor should not be soiled because it may cause failure or malfunction.
- (2) Please follow soldering conditions described in the specification. This product can permanently stop operating if the piezoelectric(pyroelectric) characteristic is decreased due to excessive heating.

3.Caution (Mounting)

(IRA Series)

(1) Soldering

- (a) Hand soldering should be applied.
- (b) Soldering should be done quickly as following.

Temperature of soldering iron : 350°C	
Distance from can case	Period of time
1 to 3mm	Within 3 seconds per point
Over 3mm	Within 10 seconds per point

- (c) Soldering flux should be rosin flux and not contain more than 0.2wt% chlorine.
 Soldering flux should be removed after soldering.
- (2) Cleaning
 Soldering flux should be removed after soldering.
 Soldering flux may cause malfunction or degradation of character unless sufficiently cleaned.

⚠Note:

1. Export Control

<For customers outside Japan>

No Murata products should be used or sold, through any channels, for use in the design, development, production, utilization, maintenance or operation of, or otherwise contribution to (1) any weapons (Weapons of Mass Destruction [nuclear, chemical or biological weapons or missiles] or conventional weapons) or (2) goods or systems specially designed or intended for military end-use or utilization by military end-users.

<For customers in Japan>

For products which are controlled items subject to the "Foreign Exchange and Foreign Trade Law" of Japan, the export license specified by the law is required for export.

2. Please contact our sales representatives or product engineers before using the products in this catalog for the applications listed below, which require especially high reliability for the prevention of defects which might directly damage a third party's life, body or property, or when one of our products is intended for use in applications other than those specified in this catalog.

- | | |
|-----------------------------|--|
| ① Aircraft equipment | ② Aerospace equipment |
| ③ Undersea equipment | ④ Power plant equipment |
| ⑤ Medical equipment | ⑥ Transportation equipment (vehicles, trains, ships, etc.) |
| ⑦ Traffic signal equipment | ⑧ Disaster prevention / crime prevention equipment |
| ⑨ Data-processing equipment | ⑩ Application of similar complexity and/or reliability requirements to the applications listed above |

3. Product specifications in this catalog are as of July 2010. They are subject to change or our products in it may be discontinued without advance notice. Please check with our sales representatives or product engineers before ordering. If there are any questions, please contact our sales representatives or product engineers.

4. Please read rating and ⚠CAUTION (for storage, operating, rating, soldering, mounting and handling) in this catalog to prevent smoking and/or burning, etc.

5. This catalog has only typical specifications because there is no space for detailed specifications. Therefore, please review our product specifications or consult the approval sheet for product specifications before ordering.

6. Please note that unless otherwise specified, we shall assume no responsibility whatsoever for any conflict or dispute that may occur in connection with the effect of our and/or a third party's intellectual property rights and other related rights in consideration of your use of our products and/or information described or contained in our catalogs. In this connection, no representation shall be made to the effect that any third parties are authorized to use the rights mentioned above under licenses without our consent.

7. No ozone depleting substances (ODS) under the Montreal Protocol are used in our manufacturing process.