

Data sheet | Item number: 788-355

Relay module; Nominal input voltage: 24 VDC; 1 make contact; Limiting continuous current: 16 A; for lamp loads; Red status indicator; Module width: 15 mm

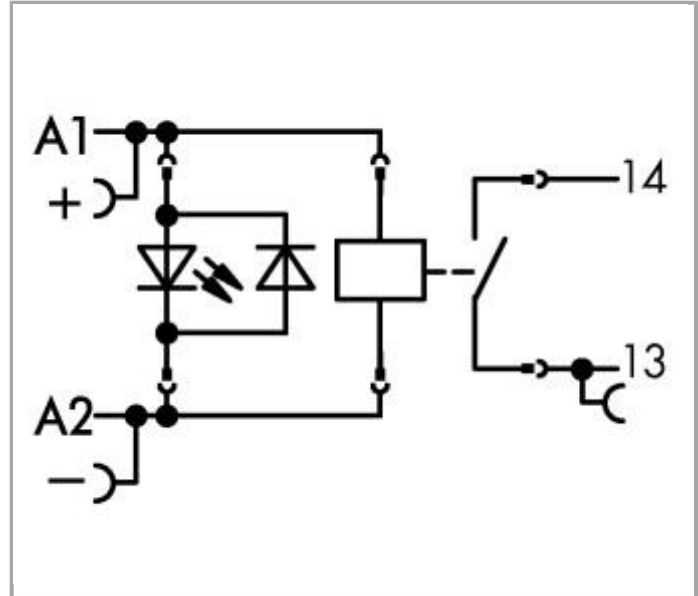

www.wago.com/788-355

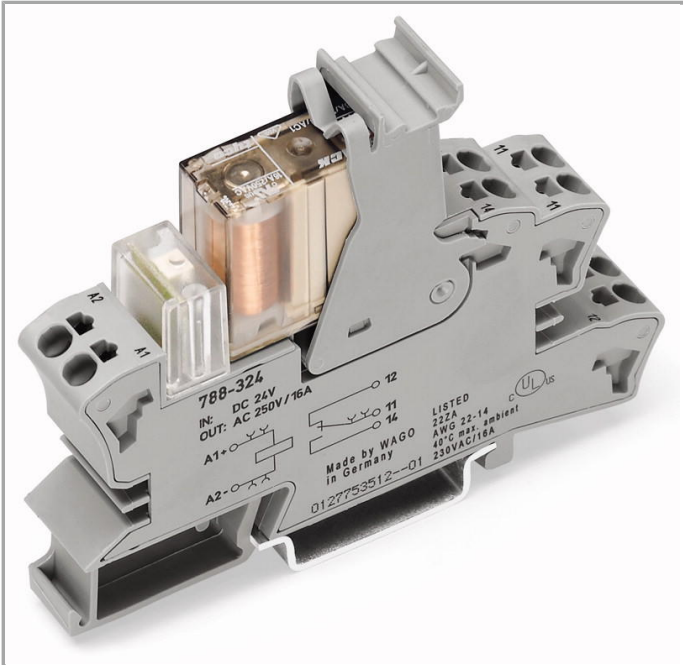

RoHS Compliant [BOMcheck.net](https://www.bomcheck.net) Similar to picture Color: ■

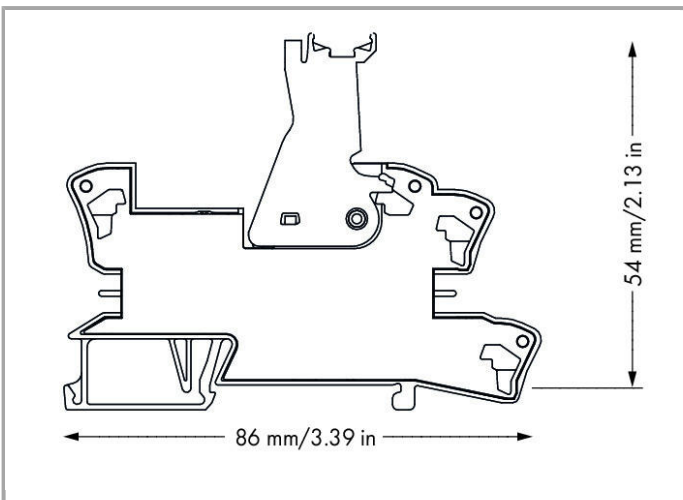

Item description

Note:

- Reinforced insulation between coil and contacts
- A separator plate (e.g., 209-191) must be used for voltages greater than 250 V between adjacent relay modules and for compliance with the reinforced insulation requirements.
- To protect the relay coils and contacts, inductive loads must be dampened with an effective protection circuit.

Data

Technical Data

Control circuit

Nominal input voltage U_N	24 VDC
Input voltage range	-15 ... +20 %
Nominal input current at U_N	21.8 mA

Load circuit:

Number of make contacts/switch on contacts	1
Contact material (relay)	AgSnO ₂
Limiting continuous current	16 A
Max. make current (resistive)	0.02 s 120 A (AC); 4 s 25 A (AC)
Max. switching voltage	250 VAC
Max. switching power (resistive)	4000 VAAC; DC see load limit curve
Pull-in time (typ.)	8 ms
Drop-out time (typ.)	2 ms
Bounce time (typ.)	2 ms
Mechanical life (N.O.; resistive load; 23 °C)	30 x 10 ⁶ switching operations

Signaling

Status indication	LED red
-------------------	---------

Safety and protection:

Rated voltage	250 V
Rated impulse voltage	4 kV
Pollution degree	3
Dielectric strength, control/load circuit (AC, 1 min)	4 kV _{rms}
Dielectric strength, control/load circuit (AC, 1 min)	4 kV _{rms}
Dielectric strength open contact (AC, 1 min)	1 kV _{rms}
Dielectric strength open contact (AC, 1 min)	1 kV _{rms}
Degree of protection	IP20



Connection data

Connection technology	Push-in CAGE CLAMP®
Solid conductor	0.34 ... 2.5 mm ² / 22 ... 14 AWG
Fine-stranded conductor	0.34 ... 2.5 mm ² / 22 ... 14 AWG
Strip length	9 ... 10 mm / 0.35 ... 0.39 Inch

Geometrical Data

Width	15 mm / 0.591 inch
Height from upper-edge of DIN-35 rail	64 mm / 2.52 inch
Depth	86 mm / 3.386 inch

Mechanical data

Type of mounting	DIN-35 rail
------------------	-------------

Material Data

Color	gray
Fire load	0.934 MJ
Weight	51.55 g

Environmental Requirements

Surrounding air (operating) temperature at U _N	-25 ... 70 °C
Surrounding air (storage) temperature	-40 ... 70 °C
Pollution degree	3

Standards and specifications

Standards/specifications	EN 61010-2-201; EN 61810-1; EN 61373; UL 508 (max. 10 A)
--------------------------	--

Commercial data

Country of origin	DE
GTIN	4045454352103
Customs Tariff No.	85364900990
Product Group	6 (Interface Electronics)





Approvals / Certificates

UL-Approvals





Logo	Approval	Certificate name
	UL	E175199 Sec.6
	UL International Netherlands B.V. (ORDINARY LOCATIONS)	

Compatible products





Jumper

	Item no.: 788-118 Comb-style jumper bar; 2-way (1-3); insulated	www.wago.com/788-118
	Item no.: 859-402 Push-in type jumper bar; 2-way; Nominal current 18 A; insulated	www.wago.com/859-402
	Item no.: 859-402/000-005 Push-in type jumper bar; 2-way; Nominal current 18 A; insulated	www.wago.com/859-402/000-005
	Item no.: 859-402/000-006 Push-in type jumper bar; 2-way; Nominal current 18 A; insulated	www.wago.com/859-402/000-006
	Item no.: 859-402/000-029 Push-in type jumper bar; 2-way; Nominal current 18 A; insulated	www.wago.com/859-402/000-029

General accessories

	Item no.: 209-145 Group marker carrier	www.wago.com/209-145
	Item no.: 209-184 Protection cover	www.wago.com/209-184
	Item no.: 249-105 Group marker carrier	www.wago.com/249-105
	Item no.: 788-120 Accessories for relay modules; Operation status indicator: red	www.wago.com/788-120

ferrule

	Item no.: 216-241 Ferrule; Sleeve for 0.5 mm ² / AWG 22; insulated; electro-tin plated; electrolytic copper; gastight crimped; acc. to DIN 46228, Part 4/09.90	www.wago.com/216-241
	Item no.: 216-242 Ferrule; Sleeve for 0.75 mm ² / AWG 20; insulated; electro-tin plated; electrolytic copper; gastight crimped; acc. to DIN 46228, Part 4/09.90	www.wago.com/216-242
	Item no.: 216-243 Ferrule; Sleeve for 1 mm ² / AWG 18; insulated; electro-tin plated; electrolytic copper; gastight crimped; acc. to DIN 46228, Part 4/09.90	www.wago.com/216-243
	Item no.: 216-244 Ferrule; Sleeve for 1.5 mm ² / AWG 16; insulated; electro-tin plated; electrolytic copper; gastight crimped; acc. to DIN 46228, Part 4/09.90	www.wago.com/216-244
	Item no.: 216-542 Twin ferrule; Sleeve for 2 x 1 mm ² / AWG 2 x 18; red, insulated; 12 mm long	www.wago.com/216-542

tools



Item no.: 210-720
Operating tool with partially insulated shaft; Type 2, blade (3.5 x 0.5) mm

www.wago.com/210-720

Marking accessories



Item no.: 2009-110
Marking strips; on reel; not stretchable; plain; snap-on type

www.wago.com/2009-110



Item no.: 2009-115
WMB-Inline; for smartPRINTER; on reel; stretchable 5 - 5.2 mm; plain; snap-on type

www.wago.com/2009-115



Item no.: 2009-115/000-002
WMB-Inline; for smartPRINTER; on reel; stretchable 5 - 5.2 mm; plain; snap-on type

www.wago.com/2009-115/000-002



Item no.: 2009-115/000-006
WMB-Inline; for smartPRINTER; on reel; stretchable 5 - 5.2 mm; plain; snap-on type

www.wago.com/2009-115/000-006



Item no.: 2009-115/000-007
WMB-Inline; for smartPRINTER; on reel; stretchable 5 - 5.2 mm; plain; snap-on type

www.wago.com/2009-115/000-007



Item no.: 2009-115/000-012
WMB-Inline; for smartPRINTER; on reel; stretchable 5 - 5.2 mm; plain; snap-on type

www.wago.com/2009-115/000-012



Item no.: 2009-115/000-017
WMB-Inline; for smartPRINTER; on reel; stretchable 5 - 5.2 mm; plain; snap-on type

www.wago.com/2009-115/000-017



Item no.: 2009-115/000-023
WMB-Inline; for smartPRINTER; on reel; stretchable 5 - 5.2 mm; plain; snap-on type

www.wago.com/2009-115/000-023



Item no.: 209-128
Adaptor

www.wago.com/209-128



Item no.: 209-183
Marker card

www.wago.com/209-183



Item no.: 210-110
Fiber-tip pen

www.wago.com/210-110



Item no.: 793-501
WMB marking card; as card; not stretchable; plain; snap-on type

www.wago.com/793-501



Item no.: 793-501/000-002
WMB marking card; as card; not stretchable; plain; snap-on type

www.wago.com/793-501/000-002



Item no.: 793-501/000-005
WMB marking card; as card; not stretchable; plain; snap-on type

www.wago.com/793-501/000-005



Item no.: 793-501/000-006
WMB marking card; as card; not stretchable; plain; snap-on type

www.wago.com/793-501/000-006



Item no.: 793-501/000-007
WMB marking card; as card; not stretchable; plain; snap-on type

www.wago.com/793-501/000-007



Item no.: 793-501/000-012
WMB marking card; as card; not stretchable; plain; snap-on type

www.wago.com/793-501/000-012



Item no.: 793-501/000-017
WMB marking card; as card; not stretchable; plain; snap-on type

www.wago.com/793-501/000-017



Item no.: 793-501/000-023
WMB marking card; as card; not stretchable; plain; snap-on type

www.wago.com/793-501/000-023



Item no.: 793-501/000-024
WMB marking card; as card; not stretchable; plain; snap-on type

www.wago.com/793-501/000-024



Item no.: 793-502
WMB marking card; as card; MARKED; 1 ... 10 (10x); not stretchable; Horizontal marking; snap-on type

www.wago.com/793-502



Item no.: 793-502/000-002
WMB marking card; as card; MARKED; 1 ... 10 (10x); not stretchable; Horizontal marking; snap-on type

www.wago.com/793-502/000-002



Item no.: 793-502/000-005
WMB marking card; as card; MARKED; 1 ... 10 (10x); not stretchable; Horizontal marking; snap-on type

www.wago.com/793-502/000-005



Item no.: 793-502/000-006
WMB marking card; as card; MARKED; 1 ... 10 (10x); not stretchable; Horizontal marking; snap-on type

www.wago.com/793-502/000-006



Item no.: 793-502/000-007
WMB marking card; as card; MARKED; 1 ... 10 (10x); not stretchable; Horizontal marking; snap-on type

www.wago.com/793-502/000-007



Item no.: 793-502/000-012
WMB marking card; as card; MARKED; 1 ... 10 (10x); not stretchable; Horizontal marking; snap-on type

www.wago.com/793-502/000-012



Item no.: 793-502/000-017
WMB marking card; as card; MARKED; 1 ... 10 (10x); not stretchable; Horizontal marking; snap-on type

www.wago.com/793-502/000-017



Item no.: 793-502/000-023
WMB marking card; as card; MARKED; 1 ... 10 (10x); not stretchable; Horizontal marking; snap-on type

www.wago.com/793-502/000-023



Item no.: 793-502/000-024
WMB marking card; as card; MARKED; 1 ... 10 (10x); not stretchable; Horizontal marking; snap-on type

www.wago.com/793-502/000-024



Item no.: 793-503
WMB marking card; as card; MARKED; 11 ... 20 (10x); not stretchable; Horizontal marking; snap-on type

www.wago.com/793-503



Item no.: 793-503/000-002

WMB marking card; as card; MARKED; 11 ... 20 (10x); not stretchable; Horizontal marking; snap-on type

www.wago.com/793-503

/000-002



Item no.: 793-503/000-005

WMB marking card; as card; MARKED; 11 ... 20 (10x); not stretchable; Horizontal marking; snap-on type

www.wago.com/793-503

/000-005



Item no.: 793-503/000-006

WMB marking card; as card; MARKED; 11 ... 20 (10x); not stretchable; Horizontal marking; snap-on type

www.wago.com/793-503

/000-006



Item no.: 793-503/000-007

WMB marking card; as card; MARKED; 11 ... 20 (10x); not stretchable; Horizontal marking; snap-on type

www.wago.com/793-503

/000-007



Item no.: 793-503/000-012

WMB marking card; as card; MARKED; 11 ... 20 (10x); not stretchable; Horizontal marking; snap-on type

www.wago.com/793-503

/000-012



Item no.: 793-503/000-017

WMB marking card; as card; MARKED; 11 ... 20 (10x); not stretchable; Horizontal marking; snap-on type

www.wago.com/793-503

/000-017



Item no.: 793-503/000-023

WMB marking card; as card; MARKED; 11 ... 20 (10x); not stretchable; Horizontal marking; snap-on type

www.wago.com/793-503

/000-023



Item no.: 793-503/000-024

WMB marking card; as card; MARKED; 11 ... 20 (10x); not stretchable; Horizontal marking; snap-on type

www.wago.com/793-503

/000-024



Item no.: 793-504

WMB marking card; as card; MARKED; 21 ... 30 (10x); not stretchable; Horizontal marking; snap-on type

www.wago.com/793-504



Item no.: 793-504/000-002

WMB marking card; as card; MARKED; 21 ... 30 (10x); not stretchable; Horizontal marking; snap-on type

www.wago.com/793-504

/000-002



Item no.: 793-504/000-005

WMB marking card; as card; MARKED; 21 ... 30 (10x); not stretchable; Horizontal marking; snap-on type

www.wago.com/793-504

/000-005



Item no.: 793-504/000-006

WMB marking card; as card; MARKED; 21 ... 30 (10x); not stretchable; Horizontal marking; snap-on type

www.wago.com/793-504

/000-006



Item no.: 793-504/000-012

WMB marking card; as card; MARKED; 21 ... 30 (10x); not stretchable; Horizontal marking; snap-on type

www.wago.com/793-504

/000-012



Item no.: 793-504/000-017

WMB marking card; as card; MARKED; 21 ... 30 (10x); not stretchable; Horizontal marking; snap-on type

www.wago.com/793-504

/000-017

















Item no.: 793-504/000-023

WMB marking card; as card; MARKED; 21 ... 30 (10x); not stretchable; Horizontal marking; snap-on type

www.wago.com/793-504

/000-023

	Item no.: 793-505 WMB marking card; as card; MARKED; 31 ... 40 (10x); not stretchable; Horizontal marking; snap-on type	www.wago.com/793-505
	Item no.: 793-505/000-005 WMB marking card; as card; MARKED; 31 ... 40 (10x); not stretchable; Horizontal marking; snap-on type	www.wago.com/793-505/000-005
	Item no.: 793-505/000-006 WMB marking card; as card; MARKED; 31 ... 40 (10x); not stretchable; Horizontal marking; snap-on type	www.wago.com/793-505/000-006
	Item no.: 793-505/000-007 WMB marking card; as card; MARKED; 31 ... 40 (10x); not stretchable; Horizontal marking; snap-on type	www.wago.com/793-505/000-007
	Item no.: 793-505/000-012 WMB marking card; as card; MARKED; 31 ... 40 (10x); not stretchable; Horizontal marking; snap-on type	www.wago.com/793-505/000-012
	Item no.: 793-506 WMB marking card; as card; MARKED; 41 ... 50 (10x); not stretchable; Horizontal marking; snap-on type	www.wago.com/793-506
	Item no.: 793-506/000-005 WMB marking card; as card; MARKED; 41 ... 50 (10x); not stretchable; Horizontal marking; snap-on type	www.wago.com/793-506/000-005
	Item no.: 793-506/000-006 WMB marking card; as card; MARKED; 41 ... 50 (10x); not stretchable; Horizontal marking; snap-on type	www.wago.com/793-506/000-006
	Item no.: 793-506/000-012 WMB marking card; as card; MARKED; 41 ... 50 (10x); not stretchable; Horizontal marking; snap-on type	www.wago.com/793-506/000-012
	Item no.: 793-506/000-017 WMB marking card; as card; MARKED; 41 ... 50 (10x); not stretchable; Horizontal marking; snap-on type	www.wago.com/793-506/000-017
	Item no.: 793-5501 WMB marking card; as card; for terminal block width 5 - 17.5 mm; stretchable 5 - 5.2 mm; plain; snap-on type	www.wago.com/793-5501
	Item no.: 793-5501/000-002 WMB marking card; as card; for terminal block width 5 - 17.5 mm; stretchable 5 - 5.2 mm; plain; snap-on type	www.wago.com/793-5501/000-002
	Item no.: 793-5501/000-005 WMB marking card; as card; stretchable 5 - 5.2 mm; plain; snap-on type	www.wago.com/793-5501/000-005
	Item no.: 793-5501/000-006 WMB marking card; as card; stretchable 5 - 5.2 mm; plain; snap-on type	www.wago.com/793-5501/000-006
	Item no.: 793-5501/000-007 WMB marking card; as card; stretchable 5 - 5.2 mm; plain; snap-on type	www.wago.com/793-5501/000-007

**Item no.: 793-5501/000-012**

WMB marking card; as card; stretchable 5 - 5.2 mm; plain; snap-on type

www.wago.com/793-5501/000-012**Item no.: 793-5501/000-014**

WMB marking card; as card; stretchable 5 - 5.2 mm; plain; snap-on type

www.wago.com/793-5501/000-014**Item no.: 793-5501/000-017**

WMB marking card; as card; stretchable 5 - 5.2 mm; plain; snap-on type

www.wago.com/793-5501/000-017**Item no.: 793-5501/000-023**

WMB marking card; as card; stretchable 5 - 5.2 mm; plain; snap-on type

www.wago.com/793-5501/000-023**Item no.: 793-5501/000-024**

WMB marking card; as card; stretchable 5 - 5.2 mm; plain; snap-on type

www.wago.com/793-5501/000-024**Item no.: 793-566**

WMB marking card; as card; MARKED; 1 ... 50 (2x); not stretchable; Horizontal marking; snap-on type

www.wago.com/793-566**Item no.: 793-566/000-002**

WMB marking card; as card; MARKED; 1 ... 50 (2x); not stretchable; Horizontal marking; snap-on type

www.wago.com/793-566/000-002**Item no.: 793-566/000-005**

WMB marking card; as card; MARKED; 1 ... 50 (2x); not stretchable; Horizontal marking; snap-on type

www.wago.com/793-566/000-005**Item no.: 793-566/000-006**

WMB marking card; as card; MARKED; 1 ... 50 (2x); not stretchable; Horizontal marking; snap-on type

www.wago.com/793-566/000-006**Item no.: 793-566/000-007**

WMB marking card; as card; MARKED; 1 ... 50 (2x); not stretchable; Horizontal marking; snap-on type

www.wago.com/793-566/000-007**Item no.: 793-566/000-012**

WMB marking card; as card; MARKED; 1 ... 50 (2x); not stretchable; Horizontal marking; snap-on type

www.wago.com/793-566/000-012**Item no.: 793-566/000-017**

WMB marking card; as card; MARKED; 1 ... 50 (2x); not stretchable; Horizontal marking; snap-on type

www.wago.com/793-566/000-017**Item no.: 793-566/000-023**

WMB marking card; as card; MARKED; 1 ... 50 (2x); not stretchable; Horizontal marking; snap-on type

www.wago.com/793-566/000-023**Item no.: 793-566/000-024**

WMB marking card; as card; MARKED; 1 ... 50 (2x); not stretchable; Horizontal marking; snap-on type

www.wago.com/793-566/000-024



Downloads

Documentation

Bid Text

788-355 Relaisbaustein	Jan 15, 2016	DOC 28.2 kB	Download
---------------------------	--------------	----------------	----------

Instruction Leaflet

Socket with Relay or SSR	Sep 28, 2015	PDF 2.1 MB	Download
--------------------------	--------------	---------------	----------

Additional Information

Disposal; Electrical and electronic equipment, Packaging	Oct 15, 2018	265.8 kB	Download
--	--------------	----------	----------

smartDATA

CAD data

3D Download 788-355		URL	Download
---------------------	--	-----	----------

Subject to changes.