

## Data sheet | Item number: 858-304

Relay module; Nominal input voltage: 24 VDC; 4 changeover contacts;  
Limiting continuous current: 5 A; with manual operation; Red status indicator;  
Module width: 31 mm

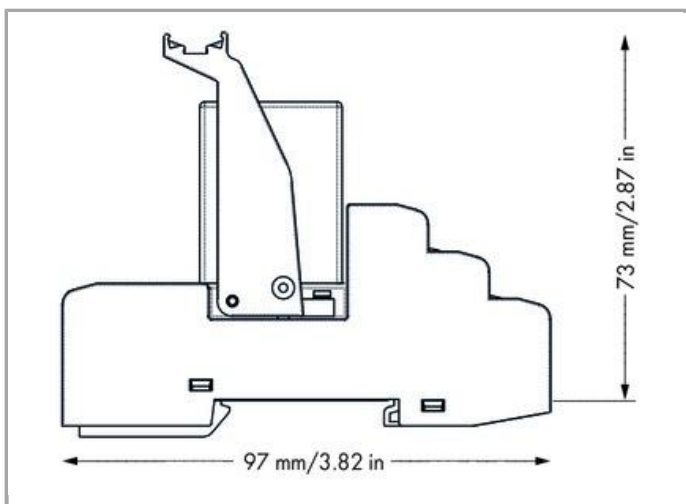

[www.wago.com/858-304](http://www.wago.com/858-304)

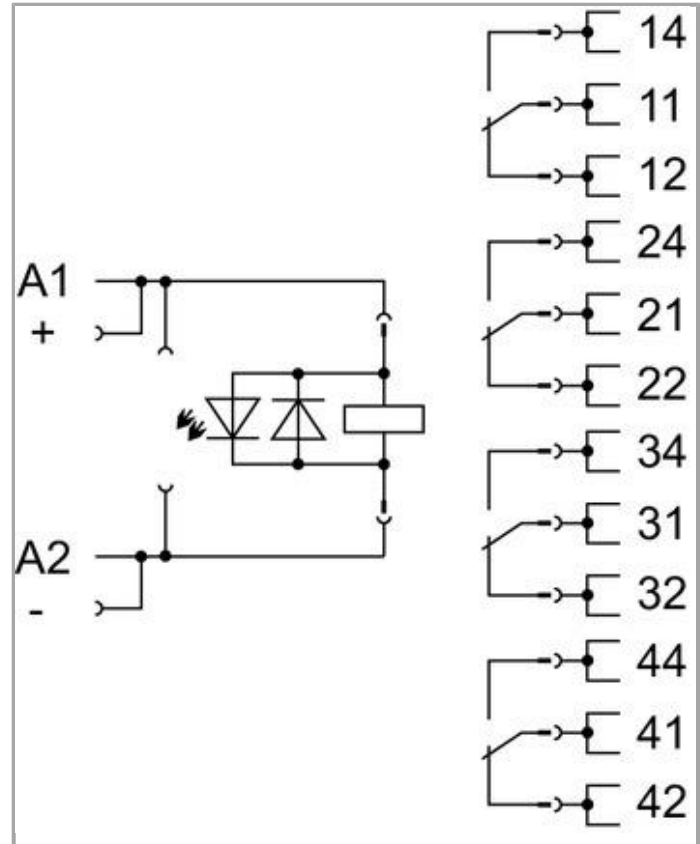

### Item description

#### Short description:

WAGO's DIN-35-rail-mount 858 Series Relay Sockets are designed for conventional industrial relays with standard pin spacing. The sockets carry 33.5 to 35.5 mm-high relays equipped with two or four changeover contacts. All socket contacts feature two conductor entries at each Push-in



CAGE CLAMP® COMPACT connection point for either 2 x 0.34 mm<sup>2</sup> (22 AWG) to 1.5 mm<sup>2</sup> (16 AWG) or 1 x 2.5 mm<sup>2</sup> (12 AWG) cross-section. Push-in CAGE CLAMP® COMPACT Spring Pressure Connection Technology provides simple, push-in termination of solid or ferruled conductors 0.5 mm<sup>2</sup> (20 AWG) and larger. Speedy socket service: rapidly replace relays without removing conductors.

## Data

### Technical Data

#### Control circuit

Nominal input voltage $U_N$	24 VDC
Input voltage range	-20 ... +10 %
Nominal input current at $U_N$	36.9 mA

#### Load circuit:

Number of changeover/switchover contacts	4
Contact material (relay)	AgCe
Limiting continuous current	5 A
Max. make current (resistive)	4 s 15 A (AC)
Max. switching voltage	250 VAC
Max. switching power (resistive)	1250 VAAC; DC see load limit curve
Recommended minimum load	12 V / 100 mA
Pull-in time (typ.)	25 ms
Drop-out time (typ.)	25 ms
Bounce time (typ.)	4 ms
Electrical life (N.O.; resistive load; 23 °C)	100 x 10 <sup>3</sup> switching operations
Mechanical life (N.O.; resistive load; 23 °C)	20 x 10 <sup>6</sup> switching operations

#### Signaling

Status indication	LED red Mechanical
-------------------	-----------------------

#### Safety and protection:

Rated voltage	250 V
Rated impulse voltage	2.5 kV
Pollution degree	2
Dielectric strength, control/load circuit (AC, 1 min)	1.5 kV <sub>rms</sub>
Dielectric strength, control/load circuit (AC, 1 min)	1.5 kV <sub>rms</sub>
Dielectric strength open contact (AC, 1 min)	1 kV <sub>rms</sub>
Dielectric strength open contact (AC, 1 min)	



	1 kV <sub>rms</sub>
Dielectric strength, load/load circuit (AC, 1 min)	1.5 kV <sub>rms</sub>
Dielectric strength, load/load circuit (AC, 1 min)	1.5 kV <sub>rms</sub>
Degree of protection	IP20

### Connection data

Number of connection types	2
Connection technology	Push-in CAGE CLAMP®
Solid conductor	0.34 ... 1.5 mm <sup>2</sup> / 22 ... 16 AWG
Fine-stranded conductor	0.34 ... 1.5 mm <sup>2</sup> / 22 ... 16 AWG
Strip length	9 ... 10 mm / 0.35 ... 0.39 Inch

### Geometrical Data

Width	31 mm / 1.22 inch
Height from upper-edge of DIN-35 rail	73 mm / 2.874 inch
Depth	97 mm / 3.819 inch

### Mechanical data

Type of mounting	DIN-35 rail
------------------	-------------

### Material Data

Weight	96 g
--------	------

### Environmental Requirements

Surrounding air (operating) temperature at U <sub>N</sub>	-25 ... 70 °C
Surrounding air (storage) temperature	-40 ... 80 °C
Surrounding air (operating) temperature for UL	-25 ... 50 °C
Pollution degree	2

### Standards and specifications

Standards/specifications	EN 61010-2-201; EN 61810-1; EN 61373; GL; UL 508 (max. 50 °C)
--------------------------	---------------------------------------------------------------

### Elementary relay

WAGO elementary relay	858-150
-----------------------	---------



### Commercial data

Country of origin	DE
-------------------	----

GTIN	4055143567770
Customs Tariff No.	85364900990
Product Group	6 (Interface Electronics)

## Approvals / Certificates

### Ship Approvals







Logo	Approval	Certificate name
	<b>DNV GL</b> Det Norske Veritas, Germanischer Lloyd	TAA00001D1
	<b>NK</b> Nippon Kaiji Kyokai	TA17255M
	<b>PRS</b> Polski Rejestr Statkow	TE/1989/880590/13

















### UL-Approvals

Logo	Approval	Certificate name
	<b>UL</b> UL International Netherlands B.V. (ORDINARY LOCATIONS)	E175199 Sec.6

## Compatible products

### Marking accessories

	<b>Item no.: 2009-110</b> Marking strips; on reel; not stretchable; plain; snap-on type	<a href="http://www.wago.com/2009-110">www.wago.com/2009-110</a>
	<b>Item no.: 2009-115</b> WMB-Inline; for smartPRINTER; on reel; stretchable 5 - 5.2 mm; plain; snap-on type	<a href="http://www.wago.com/2009-115">www.wago.com/2009-115</a>
	<b>Item no.: 2009-115/000-002</b> WMB-Inline; for smartPRINTER; on reel; stretchable 5 - 5.2 mm; plain; snap-on type	<a href="http://www.wago.com/2009-115/000-002">www.wago.com/2009-115/000-002</a>
	<b>Item no.: 2009-115/000-006</b> WMB-Inline; for smartPRINTER; on reel; stretchable 5 - 5.2 mm; plain; snap-on type	<a href="http://www.wago.com/2009-115/000-006">www.wago.com/2009-115/000-006</a>
	<b>Item no.: 2009-115/000-007</b> WMB-Inline; for smartPRINTER; on reel; stretchable 5 - 5.2 mm; plain; snap-on type	<a href="http://www.wago.com/2009-115/000-007">www.wago.com/2009-115/000-007</a>
	<b>Item no.: 2009-115/000-012</b> WMB-Inline; for smartPRINTER; on reel; stretchable 5 - 5.2 mm; plain; snap-on type	<a href="http://www.wago.com/2009-115/000-012">www.wago.com/2009-115/000-012</a>

	<p><b>Item no.: 2009-115/000-017</b>                  WMB-Inline; for smartPRINTER; on reel; stretchable 5 - 5.2 mm; plain; snap-on type</p>	<a href="http://www.wago.com/2009-115/000-017">www.wago.com/2009-115/000-017</a>
	<p><b>Item no.: 2009-115/000-023</b>                  WMB-Inline; for smartPRINTER; on reel; stretchable 5 - 5.2 mm; plain; snap-on type</p>	<a href="http://www.wago.com/2009-115/000-023">www.wago.com/2009-115/000-023</a>
	<p><b>Item no.: 2009-115/000-024</b>                  WMB-Inline; for smartPRINTER; on reel; stretchable 5 - 5.2 mm; plain; snap-on type</p>	<a href="http://www.wago.com/2009-115/000-024">www.wago.com/2009-115/000-024</a>
	<p><b>Item no.: 209-128</b>                  Adaptor</p>	<a href="http://www.wago.com/209-128">www.wago.com/209-128</a>
	<p><b>Item no.: 209-183</b>                  Marker card</p>	<a href="http://www.wago.com/209-183">www.wago.com/209-183</a>
	<p><b>Item no.: 210-110</b>                  Fiber-tip pen</p>	<a href="http://www.wago.com/210-110">www.wago.com/210-110</a>
	<p><b>Item no.: 793-501</b>                  WMB marking card; as card; not stretchable; plain; snap-on type</p>	<a href="http://www.wago.com/793-501">www.wago.com/793-501</a>
	<p><b>Item no.: 793-501/000-002</b>                  WMB marking card; as card; not stretchable; plain; snap-on type</p>	<a href="http://www.wago.com/793-501/000-002">www.wago.com/793-501/000-002</a>
	<p><b>Item no.: 793-501/000-005</b>                  WMB marking card; as card; not stretchable; plain; snap-on type</p>	<a href="http://www.wago.com/793-501/000-005">www.wago.com/793-501/000-005</a>
	<p><b>Item no.: 793-501/000-006</b>                  WMB marking card; as card; not stretchable; plain; snap-on type</p>	<a href="http://www.wago.com/793-501/000-006">www.wago.com/793-501/000-006</a>
	<p><b>Item no.: 793-501/000-007</b>                  WMB marking card; as card; not stretchable; plain; snap-on type</p>	<a href="http://www.wago.com/793-501/000-007">www.wago.com/793-501/000-007</a>
	<p><b>Item no.: 793-501/000-012</b>                  WMB marking card; as card; not stretchable; plain; snap-on type</p>	<a href="http://www.wago.com/793-501/000-012">www.wago.com/793-501/000-012</a>
	<p><b>Item no.: 793-501/000-017</b>                  WMB marking card; as card; not stretchable; plain; snap-on type</p>	<a href="http://www.wago.com/793-501/000-017">www.wago.com/793-501/000-017</a>
	<p><b>Item no.: 793-501/000-023</b>                  WMB marking card; as card; not stretchable; plain; snap-on type</p>	<a href="http://www.wago.com/793-501/000-023">www.wago.com/793-501/000-023</a>
	<p><b>Item no.: 793-501/000-024</b>                  WMB marking card; as card; not stretchable; plain; snap-on type</p>	<a href="http://www.wago.com/793-501/000-024">www.wago.com/793-501/000-024</a>
	<p><b>Item no.: 793-502</b>                  WMB marking card; as card; MARKED; 1 ... 10 (10x); not stretchable; Horizontal marking; snap-on type</p>	<a href="http://www.wago.com/793-502">www.wago.com/793-502</a>



**Item no.: 793-502/000-002**  
WMB marking card; as card; MARKED; 1 ... 10 (10x); not stretchable; Horizontal marking; snap-on type

[www.wago.com/793-502/000-002](http://www.wago.com/793-502/000-002)



**Item no.: 793-502/000-005**  
WMB marking card; as card; MARKED; 1 ... 10 (10x); not stretchable; Horizontal marking; snap-on type

[www.wago.com/793-502/000-005](http://www.wago.com/793-502/000-005)



**Item no.: 793-502/000-006**  
WMB marking card; as card; MARKED; 1 ... 10 (10x); not stretchable; Horizontal marking; snap-on type

[www.wago.com/793-502/000-006](http://www.wago.com/793-502/000-006)



**Item no.: 793-502/000-007**  
WMB marking card; as card; MARKED; 1 ... 10 (10x); not stretchable; Horizontal marking; snap-on type

[www.wago.com/793-502/000-007](http://www.wago.com/793-502/000-007)



**Item no.: 793-502/000-012**  
WMB marking card; as card; MARKED; 1 ... 10 (10x); not stretchable; Horizontal marking; snap-on type

[www.wago.com/793-502/000-012](http://www.wago.com/793-502/000-012)



**Item no.: 793-502/000-017**  
WMB marking card; as card; MARKED; 1 ... 10 (10x); not stretchable; Horizontal marking; snap-on type

[www.wago.com/793-502/000-017](http://www.wago.com/793-502/000-017)



**Item no.: 793-502/000-023**  
WMB marking card; as card; MARKED; 1 ... 10 (10x); not stretchable; Horizontal marking; snap-on type

[www.wago.com/793-502/000-023](http://www.wago.com/793-502/000-023)



**Item no.: 793-502/000-024**  
WMB marking card; as card; MARKED; 1 ... 10 (10x); not stretchable; Horizontal marking; snap-on type

[www.wago.com/793-502/000-024](http://www.wago.com/793-502/000-024)



**Item no.: 793-503**  
WMB marking card; as card; MARKED; 11 ... 20 (10x); not stretchable; Horizontal marking; snap-on type

[www.wago.com/793-503](http://www.wago.com/793-503)



**Item no.: 793-503/000-002**  
WMB marking card; as card; MARKED; 11 ... 20 (10x); not stretchable; Horizontal marking; snap-on type

[www.wago.com/793-503/000-002](http://www.wago.com/793-503/000-002)



**Item no.: 793-503/000-005**  
WMB marking card; as card; MARKED; 11 ... 20 (10x); not stretchable; Horizontal marking; snap-on type

[www.wago.com/793-503/000-005](http://www.wago.com/793-503/000-005)



**Item no.: 793-503/000-006**  
WMB marking card; as card; MARKED; 11 ... 20 (10x); not stretchable; Horizontal marking; snap-on type

[www.wago.com/793-503/000-006](http://www.wago.com/793-503/000-006)



**Item no.: 793-503/000-007**  
WMB marking card; as card; MARKED; 11 ... 20 (10x); not stretchable; Horizontal marking; snap-on type

[www.wago.com/793-503/000-007](http://www.wago.com/793-503/000-007)



**Item no.: 793-503/000-012**  
WMB marking card; as card; MARKED; 11 ... 20 (10x); not stretchable; Horizontal marking; snap-on type

[www.wago.com/793-503/000-012](http://www.wago.com/793-503/000-012)



**Item no.: 793-503/000-017**  
WMB marking card; as card; MARKED; 11 ... 20 (10x); not stretchable; Horizontal marking; snap-on type

[www.wago.com/793-503/000-017](http://www.wago.com/793-503/000-017)

**Item no.: 793-503/000-023**

WMB marking card; as card; MARKED; 11 ... 20 (10x); not stretchable; Horizontal marking; snap-on type

[www.wago.com/793-503](http://www.wago.com/793-503)

/000-023

**Item no.: 793-503/000-024**

WMB marking card; as card; MARKED; 11 ... 20 (10x); not stretchable; Horizontal marking; snap-on type

[www.wago.com/793-503](http://www.wago.com/793-503)

/000-024

**Item no.: 793-504**

WMB marking card; as card; MARKED; 21 ... 30 (10x); not stretchable; Horizontal marking; snap-on type

[www.wago.com/793-504](http://www.wago.com/793-504)**Item no.: 793-504/000-002**

WMB marking card; as card; MARKED; 21 ... 30 (10x); not stretchable; Horizontal marking; snap-on type

[www.wago.com/793-504](http://www.wago.com/793-504)

/000-002

**Item no.: 793-504/000-005**

WMB marking card; as card; MARKED; 21 ... 30 (10x); not stretchable; Horizontal marking; snap-on type

[www.wago.com/793-504](http://www.wago.com/793-504)

/000-005

**Item no.: 793-504/000-006**

WMB marking card; as card; MARKED; 21 ... 30 (10x); not stretchable; Horizontal marking; snap-on type

[www.wago.com/793-504](http://www.wago.com/793-504)

/000-006

**Item no.: 793-504/000-012**

WMB marking card; as card; MARKED; 21 ... 30 (10x); not stretchable; Horizontal marking; snap-on type

[www.wago.com/793-504](http://www.wago.com/793-504)

/000-012

**Item no.: 793-504/000-017**

WMB marking card; as card; MARKED; 21 ... 30 (10x); not stretchable; Horizontal marking; snap-on type

[www.wago.com/793-504](http://www.wago.com/793-504)

/000-017

**Item no.: 793-504/000-023**

WMB marking card; as card; MARKED; 21 ... 30 (10x); not stretchable; Horizontal marking; snap-on type

[www.wago.com/793-504](http://www.wago.com/793-504)

/000-023

**Item no.: 793-505**

WMB marking card; as card; MARKED; 31 ... 40 (10x); not stretchable; Horizontal marking; snap-on type

[www.wago.com/793-505](http://www.wago.com/793-505)**Item no.: 793-505/000-005**

WMB marking card; as card; MARKED; 31 ... 40 (10x); not stretchable; Horizontal marking; snap-on type

[www.wago.com/793-505](http://www.wago.com/793-505)

/000-005

**Item no.: 793-505/000-006**

WMB marking card; as card; MARKED; 31 ... 40 (10x); not stretchable; Horizontal marking; snap-on type

[www.wago.com/793-505](http://www.wago.com/793-505)

/000-006

**Item no.: 793-505/000-007**

WMB marking card; as card; MARKED; 31 ... 40 (10x); not stretchable; Horizontal marking; snap-on type

[www.wago.com/793-505](http://www.wago.com/793-505)

/000-007

**Item no.: 793-505/000-012**

WMB marking card; as card; MARKED; 31 ... 40 (10x); not stretchable; Horizontal marking; snap-on type

[www.wago.com/793-505](http://www.wago.com/793-505)

/000-012

**Item no.: 793-506**

WMB marking card; as card; MARKED; 41 ... 50 (10x); not stretchable; Horizontal marking; snap-on type

[www.wago.com/793-506](http://www.wago.com/793-506)**Item no.: 793-506/000-005**

WMB marking card; as card; MARKED; 41 ... 50 (10x); not stretchable; Horizontal marking; snap-on type

[www.wago.com/793-506](http://www.wago.com/793-506)

/000-005

**Item no.: 793-506/000-006**

WMB marking card; as card; MARKED; 41 ... 50 (10x); not stretchable; Horizontal marking; snap-on type

[www.wago.com/793-506/000-006](http://www.wago.com/793-506/000-006)**Item no.: 793-506/000-012**

WMB marking card; as card; MARKED; 41 ... 50 (10x); not stretchable; Horizontal marking; snap-on type

[www.wago.com/793-506/000-012](http://www.wago.com/793-506/000-012)**Item no.: 793-506/000-017**

WMB marking card; as card; MARKED; 41 ... 50 (10x); not stretchable; Horizontal marking; snap-on type

[www.wago.com/793-506/000-017](http://www.wago.com/793-506/000-017)**Item no.: 793-5501**

WMB marking card; as card; for terminal block width 5 - 17.5 mm; stretchable 5 - 5.2 mm; plain; snap-on type

[www.wago.com/793-5501](http://www.wago.com/793-5501)**Item no.: 793-5501/000-002**

WMB marking card; as card; for terminal block width 5 - 17.5 mm; stretchable 5 - 5.2 mm; plain; snap-on type

[www.wago.com/793-5501/000-002](http://www.wago.com/793-5501/000-002)**Item no.: 793-5501/000-005**

WMB marking card; as card; stretchable 5 - 5.2 mm; plain; snap-on type

[www.wago.com/793-5501/000-005](http://www.wago.com/793-5501/000-005)**Item no.: 793-5501/000-006**

WMB marking card; as card; stretchable 5 - 5.2 mm; plain; snap-on type

[www.wago.com/793-5501/000-006](http://www.wago.com/793-5501/000-006)**Item no.: 793-5501/000-007**

WMB marking card; as card; stretchable 5 - 5.2 mm; plain; snap-on type

[www.wago.com/793-5501/000-007](http://www.wago.com/793-5501/000-007)**Item no.: 793-5501/000-012**

WMB marking card; as card; stretchable 5 - 5.2 mm; plain; snap-on type

[www.wago.com/793-5501/000-012](http://www.wago.com/793-5501/000-012)**Item no.: 793-5501/000-014**

WMB marking card; as card; stretchable 5 - 5.2 mm; plain; snap-on type

[www.wago.com/793-5501/000-014](http://www.wago.com/793-5501/000-014)**Item no.: 793-5501/000-017**

WMB marking card; as card; stretchable 5 - 5.2 mm; plain; snap-on type

[www.wago.com/793-5501/000-017](http://www.wago.com/793-5501/000-017)**Item no.: 793-5501/000-023**

WMB marking card; as card; stretchable 5 - 5.2 mm; plain; snap-on type

[www.wago.com/793-5501/000-023](http://www.wago.com/793-5501/000-023)**Item no.: 793-5501/000-024**

WMB marking card; as card; stretchable 5 - 5.2 mm; plain; snap-on type

[www.wago.com/793-5501/000-024](http://www.wago.com/793-5501/000-024)**Item no.: 793-566**

WMB marking card; as card; MARKED; 1 ... 50 (2x); not stretchable; Horizontal marking; snap-on type

[www.wago.com/793-566](http://www.wago.com/793-566)



**Item no.: 793-566/000-002**

WMB marking card; as card; MARKED; 1 ... 50 (2x); not stretchable; Horizontal marking; snap-on type

[www.wago.com/793-566/000-002](http://www.wago.com/793-566/000-002)**Item no.: 793-566/000-005**

WMB marking card; as card; MARKED; 1 ... 50 (2x); not stretchable; Horizontal marking; snap-on type

[www.wago.com/793-566/000-005](http://www.wago.com/793-566/000-005)**Item no.: 793-566/000-006**

WMB marking card; as card; MARKED; 1 ... 50 (2x); not stretchable; Horizontal marking; snap-on type

[www.wago.com/793-566/000-006](http://www.wago.com/793-566/000-006)**Item no.: 793-566/000-007**

WMB marking card; as card; MARKED; 1 ... 50 (2x); not stretchable; Horizontal marking; snap-on type

[www.wago.com/793-566/000-007](http://www.wago.com/793-566/000-007)**Item no.: 793-566/000-012**

WMB marking card; as card; MARKED; 1 ... 50 (2x); not stretchable; Horizontal marking; snap-on type

[www.wago.com/793-566/000-012](http://www.wago.com/793-566/000-012)**Item no.: 793-566/000-017**

WMB marking card; as card; MARKED; 1 ... 50 (2x); not stretchable; Horizontal marking; snap-on type

[www.wago.com/793-566/000-017](http://www.wago.com/793-566/000-017)**Item no.: 793-566/000-023**

WMB marking card; as card; MARKED; 1 ... 50 (2x); not stretchable; Horizontal marking; snap-on type

[www.wago.com/793-566/000-023](http://www.wago.com/793-566/000-023)**Item no.: 793-566/000-024**

WMB marking card; as card; MARKED; 1 ... 50 (2x); not stretchable; Horizontal marking; snap-on type

[www.wago.com/793-566/000-024](http://www.wago.com/793-566/000-024)

### Jumper

**Item no.: 858-402**

Push-in type jumper bar; for the coil side

[www.wago.com/858-402](http://www.wago.com/858-402)

### tools

**Item no.: 210-719**







Operating tool with partially insulated shaft; Type 1, blade (2.5 x 0.4) mm

[www.wago.com/210-719](http://www.wago.com/210-719)

### ferrule

**Item no.: 216-241**Ferrule; Sleeve for 0.5 mm<sup>2</sup> / AWG 22; insulated; electro-tin plated; electrolytic copper; gastight crimped; acc. to DIN 46228, Part 4/09.90[www.wago.com/216-241](http://www.wago.com/216-241)**Item no.: 216-242**Ferrule; Sleeve for 0.75 mm<sup>2</sup> / AWG 20; insulated; electro-tin plated; electrolytic copper; gastight crimped; acc. to DIN 46228, Part 4/09.90[www.wago.com/216-242](http://www.wago.com/216-242)**Item no.: 216-243**Ferrule; Sleeve for 1 mm<sup>2</sup> / AWG 18; insulated; electro-tin plated; electrolytic copper; gastight crimped; acc. to DIN 46228, Part 4/09.90[www.wago.com/216-243](http://www.wago.com/216-243)**Item no.: 216-244**Ferrule; Sleeve for 1.5 mm<sup>2</sup> / AWG 16; insulated; electro-tin plated; electrolytic copper; gastight crimped; acc. to DIN 46228, Part 4/09.90[www.wago.com/216-244](http://www.wago.com/216-244)

### General accessories

	<b>Item no.: 209-145</b> Group marker carrier	<a href="http://www.wago.com/209-145">www.wago.com/209-145</a>
	<b>Item no.: 209-184</b> Protection cover	<a href="http://www.wago.com/209-184">www.wago.com/209-184</a>
	<b>Item no.: 249-105</b> Group marker carrier	<a href="http://www.wago.com/249-105">www.wago.com/249-105</a>
	<b>Item no.: 788-120</b> Accessories for relay modules; Operation status indicator: red	<a href="http://www.wago.com/788-120">www.wago.com/788-120</a>
	<b>Item no.: 858-110</b> Holding bracket for industrial relays (height 33.5 mm ... 35.5 mm)	<a href="http://www.wago.com/858-110">www.wago.com/858-110</a>
	<b>Item no.: 858-150</b> Basic relay; Nominal input voltage: 24 VDC; 4 changeover contacts; Limiting continuous current: 5 A; with manual operation; Module width: 22 mm; Module height: 25 mm	<a href="http://www.wago.com/858-150">www.wago.com/858-150</a>

### Downloads

#### Documentation

##### Bid Text

858-304 Relaisbaustein	Jan 15, 2016	DOC 28.7 kB	Download
---------------------------	--------------	----------------	----------

##### Instruction Leaflet

Sockets for Elementary Relays	Dec 9, 2016	PDF 2.6 MB	Download
-------------------------------	-------------	---------------	----------

##### Additional Information

Disposal; Electrical and electronic equipment, Packaging	Oct 15, 2018	265.8 kB	Download
----------------------------------------------------------	--------------	----------	----------

### smartDATA

#### CAD data

3D Download 858-304	URL	Download
---------------------	-----	----------



Subject to changes.

---

WAGO Kontakttechnik GmbH & Co. KG  
Hansastr. 27  
32423 Minden  
Phone: +49571 887-0 | Fax: +49571 887-169  
Email: [info.de@wago.com](mailto:info.de@wago.com) | Web: [www.wago.com](http://www.wago.com)

Do you have any questions about our products?  
We are always happy to take your call at +49 (571) 887-44222.