

Data sheet | Item number: 858-518

Relay module; Nominal input voltage: 230 VAC; 4 changeover contacts;
Limiting continuous current: 5 A; with gold contacts; with manual operation;
Red status indicator; Module width: 31 mm

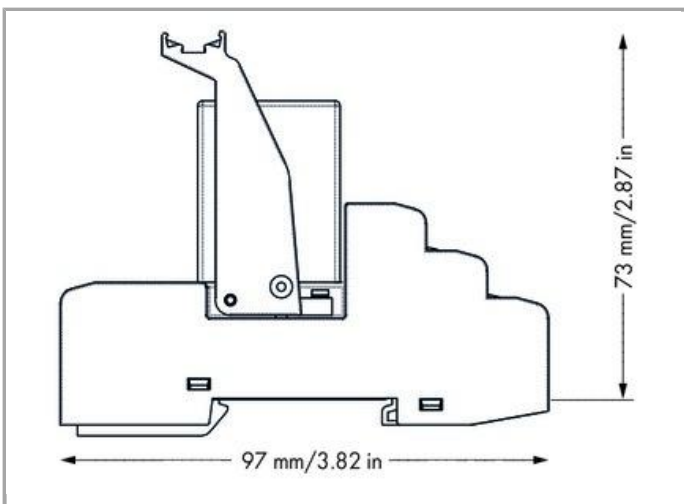

www.wago.com/858-518

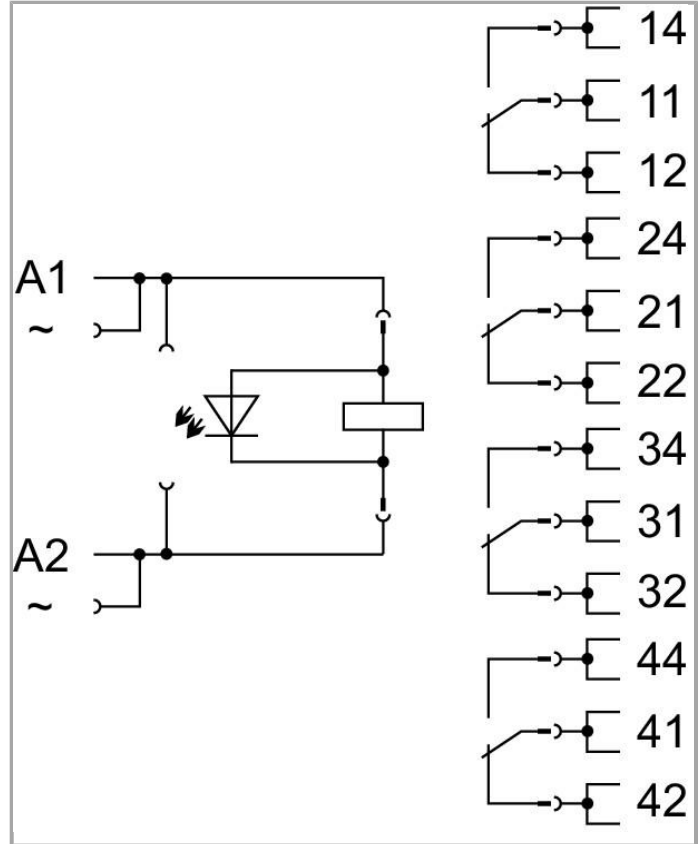

Item description

Short description:



WAGO's DIN-35-rail-mount 858 Series Relay Sockets are designed for conventional industrial relays with standard pin spacing. The sockets carry 33.5 to 35.5 mm-high relays equipped with two or four changeover contacts. All socket contacts feature two conductor entries at each Push-in CAGE CLAMP® COMPACT connection point for either 2 x 0.34 mm² (22 AWG) to 1.5 mm² (16 AWG) or 1 x 2.5 mm² (12 AWG) cross-section. Push-in CAGE CLAMP® COMPACT Spring Pressure Connection Technology provides simple, push-in termination of solid or ferruled conductors 0.5 mm² (20 AWG) and larger. Speedy socket service: rapidly replace relays without removing conductors.

Note:

*To prevent damaging the gold layer, 30 VDC switching voltages and 50 mA currents shall not be exceeded. Higher switching power eventually evaporates the gold layer. The resulting deposits in the housing may reduce the service life.

Data**Technical Data****Control circuit**

Nominal input voltage U_N	230 VAC
Input voltage range	-20 ... +10 %
Nominal input current at U_N	8.3 mA

Load circuit:

Number of changeover/switchover contacts	4
Contact material (relay)	AgCe + Au
Limiting continuous current	5 A
Max. make current (resistive)	4 s 15 A (AC)
Max. switching voltage	250 VAC
Max. switching power (resistive)	1250 VAAC; DC see load limit curve
Recommended minimum load	5 V / 1 mA / 50 mW
Pull-in time (typ.)	25 ms
Drop-out time (typ.)	25 ms
Bounce time (typ)	4 ms
Electrical life (N.O.; resistive load; 23 °C)	100 x 10 ³ switching operations
Mechanical life (N.O.; resistive load; 23 °C)	20 x 10 ⁶ switching operations

Signaling

Status indication	LED red Mechanical
-------------------	-----------------------

Safety and protection:

Rated voltage	250 V
---------------	-------

Rated impulse voltage	2.5 kV
Pollution degree	2
Dielectric strength, control/load circuit (AC, 1 min)	1.5 kV _{rms}
Dielectric strength, control/load circuit (AC, 1 min)	1.5 kV _{rms}
Dielectric strength open contact (AC, 1 min)	1 kV _{rms}
Dielectric strength open contact (AC, 1 min)	1 kV _{rms}
Dielectric strength, load/load circuit (AC, 1 min)	1.5 kV _{rms}
Dielectric strength, load/load circuit (AC, 1 min)	1.5 kV _{rms}
Degree of protection	IP20

Connection data

Number of connection types	2
Connection technology	Push-in CAGE CLAMP®
Solid conductor	0.34 ... 1.5 mm ² / 22 ... 16 AWG
Fine-stranded conductor	0.34 ... 1.5 mm ² / 22 ... 16 AWG
Strip length	9 ... 10 mm / 0.35 ... 0.39 Inch

Geometrical Data

Width	31 mm / 1.22 inch
Height from upper-edge of DIN-35 rail	73 mm / 2.874 inch
Depth	97 mm / 3.819 inch

Mechanical data

Type of mounting	DIN-35 rail
------------------	-------------

Material Data

Weight	96.2 g
--------	--------

Environmental Requirements

Surrounding air (operating) temperature at U _N	-25 ... 70 °C
Surrounding air (storage) temperature	-40 ... 80 °C
Surrounding air (operating) temperature for UL	-25 ... 50 °C
Pollution degree	2

Standards and specifications

Standards/specifications	EN 61010-2-201; EN 61810-1; EN 61373; GL; UL 508 (max. 50 °C)
--------------------------	---

Elementary relay

WAGO elementary relay

858-153

Commercial data

Country of origin	DE
GTIN	4055143568210
Customs Tariff No.	85364900990
Product Group	6 (Interface Electronics)

Approvals / Certificates

Ship Approvals

Logo	Approval	Certificate name
	DNV GL Det Norske Veritas, Germanischer Lloyd	TAA00001D1
	NK Nippon Kaiji Kyokai	TA17255M
	PRS Polski Rejestr Statkow	TE/1989/880590/13

UL-Approvals

Logo	Approval	Certificate name
	UL UL International Netherlands B.V. (ORDINARY LOCATIONS)	E175199 Sec.6

Compatible products

Jumper



Item no.: 858-402

Push-in type jumper bar; for the coil side

www.wago.com/858-402

tools



Item no.: 210-719

Operating tool with partially insulated shaft; Type 1, blade (2.5 x 0.4) mm

www.wago.com/210-719

















Marking accessories



Item no.: 2009-110

Marking strips; on reel; not stretchable; plain; snap-on type

www.wago.com/2009-110

	Item no.: 2009-115 WMB-Inline; for smartPRINTER; on reel; stretchable 5 - 5.2 mm; plain; snap-on type	www.wago.com/2009-115
	Item no.: 2009-115/000-002 WMB-Inline; for smartPRINTER; on reel; stretchable 5 - 5.2 mm; plain; snap-on type	www.wago.com/2009-115/000-002
	Item no.: 2009-115/000-006 WMB-Inline; for smartPRINTER; on reel; stretchable 5 - 5.2 mm; plain; snap-on type	www.wago.com/2009-115/000-006
	Item no.: 2009-115/000-007 WMB-Inline; for smartPRINTER; on reel; stretchable 5 - 5.2 mm; plain; snap-on type	www.wago.com/2009-115/000-007
	Item no.: 2009-115/000-012 WMB-Inline; for smartPRINTER; on reel; stretchable 5 - 5.2 mm; plain; snap-on type	www.wago.com/2009-115/000-012
	Item no.: 2009-115/000-017 WMB-Inline; for smartPRINTER; on reel; stretchable 5 - 5.2 mm; plain; snap-on type	www.wago.com/2009-115/000-017
	Item no.: 2009-115/000-023 WMB-Inline; for smartPRINTER; on reel; stretchable 5 - 5.2 mm; plain; snap-on type	www.wago.com/2009-115/000-023
	Item no.: 2009-115/000-024 WMB-Inline; for smartPRINTER; on reel; stretchable 5 - 5.2 mm; plain; snap-on type	www.wago.com/2009-115/000-024
	Item no.: 209-128 Adaptor	www.wago.com/209-128
	Item no.: 209-183 Marker card	www.wago.com/209-183
	Item no.: 210-110 Fiber-tip pen	www.wago.com/210-110
	Item no.: 793-501 WMB marking card; as card; not stretchable; plain; snap-on type	www.wago.com/793-501
	Item no.: 793-501/000-002 WMB marking card; as card; not stretchable; plain; snap-on type	www.wago.com/793-501/000-002
	Item no.: 793-501/000-005 WMB marking card; as card; not stretchable; plain; snap-on type	www.wago.com/793-501/000-005
	Item no.: 793-501/000-006 WMB marking card; as card; not stretchable; plain; snap-on type	www.wago.com/793-501/000-006
	Item no.: 793-501/000-007 WMB marking card; as card; not stretchable; plain; snap-on type	www.wago.com/793-501/000-007



Item no.: 793-501/000-012
WMB marking card; as card; not stretchable; plain; snap-on type

www.wago.com/793-501/000-012



Item no.: 793-501/000-017
WMB marking card; as card; not stretchable; plain; snap-on type

www.wago.com/793-501/000-017



Item no.: 793-501/000-023
WMB marking card; as card; not stretchable; plain; snap-on type

www.wago.com/793-501/000-023



Item no.: 793-501/000-024
WMB marking card; as card; not stretchable; plain; snap-on type

www.wago.com/793-501/000-024



Item no.: 793-502
WMB marking card; as card; MARKED; 1 ... 10 (10x); not stretchable; Horizontal marking; snap-on type

www.wago.com/793-502



Item no.: 793-502/000-002
WMB marking card; as card; MARKED; 1 ... 10 (10x); not stretchable; Horizontal marking; snap-on type

www.wago.com/793-502/000-002



Item no.: 793-502/000-005
WMB marking card; as card; MARKED; 1 ... 10 (10x); not stretchable; Horizontal marking; snap-on type

www.wago.com/793-502/000-005



Item no.: 793-502/000-006
WMB marking card; as card; MARKED; 1 ... 10 (10x); not stretchable; Horizontal marking; snap-on type

www.wago.com/793-502/000-006



Item no.: 793-502/000-007
WMB marking card; as card; MARKED; 1 ... 10 (10x); not stretchable; Horizontal marking; snap-on type

www.wago.com/793-502/000-007



Item no.: 793-502/000-012
WMB marking card; as card; MARKED; 1 ... 10 (10x); not stretchable; Horizontal marking; snap-on type

www.wago.com/793-502/000-012



Item no.: 793-502/000-017
WMB marking card; as card; MARKED; 1 ... 10 (10x); not stretchable; Horizontal marking; snap-on type

www.wago.com/793-502/000-017



Item no.: 793-502/000-023
WMB marking card; as card; MARKED; 1 ... 10 (10x); not stretchable; Horizontal marking; snap-on type

www.wago.com/793-502/000-023



Item no.: 793-502/000-024
WMB marking card; as card; MARKED; 1 ... 10 (10x); not stretchable; Horizontal marking; snap-on type

www.wago.com/793-502/000-024



Item no.: 793-503
WMB marking card; as card; MARKED; 11 ... 20 (10x); not stretchable; Horizontal marking; snap-on type

www.wago.com/793-503



Item no.: 793-503/000-002
WMB marking card; as card; MARKED; 11 ... 20 (10x); not stretchable; Horizontal marking; snap-on type

www.wago.com/793-503/000-002



Item no.: 793-503/000-005 www.wago.com/793-503/000-005
 WMB marking card; as card; MARKED; 11 ... 20 (10x); not stretchable; Horizontal marking; snap-on type



Item no.: 793-503/000-006 www.wago.com/793-503/000-006
 WMB marking card; as card; MARKED; 11 ... 20 (10x); not stretchable; Horizontal marking; snap-on type



Item no.: 793-503/000-007 www.wago.com/793-503/000-007
 WMB marking card; as card; MARKED; 11 ... 20 (10x); not stretchable; Horizontal marking; snap-on type



Item no.: 793-503/000-012 www.wago.com/793-503/000-012
 WMB marking card; as card; MARKED; 11 ... 20 (10x); not stretchable; Horizontal marking; snap-on type



Item no.: 793-503/000-017 www.wago.com/793-503/000-017
 WMB marking card; as card; MARKED; 11 ... 20 (10x); not stretchable; Horizontal marking; snap-on type



Item no.: 793-503/000-023 www.wago.com/793-503/000-023
 WMB marking card; as card; MARKED; 11 ... 20 (10x); not stretchable; Horizontal marking; snap-on type



Item no.: 793-503/000-024 www.wago.com/793-503/000-024
 WMB marking card; as card; MARKED; 11 ... 20 (10x); not stretchable; Horizontal marking; snap-on type



Item no.: 793-504 www.wago.com/793-504
 WMB marking card; as card; MARKED; 21 ... 30 (10x); not stretchable; Horizontal marking; snap-on type



Item no.: 793-504/000-002 www.wago.com/793-504/000-002
 WMB marking card; as card; MARKED; 21 ... 30 (10x); not stretchable; Horizontal marking; snap-on type



Item no.: 793-504/000-005 www.wago.com/793-504/000-005
 WMB marking card; as card; MARKED; 21 ... 30 (10x); not stretchable; Horizontal marking; snap-on type



Item no.: 793-504/000-006 www.wago.com/793-504/000-006
 WMB marking card; as card; MARKED; 21 ... 30 (10x); not stretchable; Horizontal marking; snap-on type



Item no.: 793-504/000-012 www.wago.com/793-504/000-012
 WMB marking card; as card; MARKED; 21 ... 30 (10x); not stretchable; Horizontal marking; snap-on type



Item no.: 793-504/000-017 www.wago.com/793-504/000-017
 WMB marking card; as card; MARKED; 21 ... 30 (10x); not stretchable; Horizontal marking; snap-on type



Item no.: 793-504/000-023 www.wago.com/793-504/000-023
 WMB marking card; as card; MARKED; 21 ... 30 (10x); not stretchable; Horizontal marking; snap-on type



Item no.: 793-505 www.wago.com/793-505
 WMB marking card; as card; MARKED; 31 ... 40 (10x); not stretchable; Horizontal marking; snap-on type

**Item no.: 793-505/000-005**WMB marking card; as card; MARKED; 31 ... 40 (10x); not stretchable; Horizontal marking; snap-on type www.wago.com/793-505/000-005**Item no.: 793-505/000-006**WMB marking card; as card; MARKED; 31 ... 40 (10x); not stretchable; Horizontal marking; snap-on type www.wago.com/793-505/000-006**Item no.: 793-505/000-007**WMB marking card; as card; MARKED; 31 ... 40 (10x); not stretchable; Horizontal marking; snap-on type www.wago.com/793-505/000-007**Item no.: 793-505/000-012**WMB marking card; as card; MARKED; 31 ... 40 (10x); not stretchable; Horizontal marking; snap-on type www.wago.com/793-505/000-012**Item no.: 793-506**WMB marking card; as card; MARKED; 41 ... 50 (10x); not stretchable; Horizontal marking; snap-on type www.wago.com/793-506**Item no.: 793-506/000-005**WMB marking card; as card; MARKED; 41 ... 50 (10x); not stretchable; Horizontal marking; snap-on type www.wago.com/793-506/000-005**Item no.: 793-506/000-006**WMB marking card; as card; MARKED; 41 ... 50 (10x); not stretchable; Horizontal marking; snap-on type www.wago.com/793-506/000-006**Item no.: 793-506/000-012**WMB marking card; as card; MARKED; 41 ... 50 (10x); not stretchable; Horizontal marking; snap-on type www.wago.com/793-506/000-012**Item no.: 793-506/000-017**WMB marking card; as card; MARKED; 41 ... 50 (10x); not stretchable; Horizontal marking; snap-on type www.wago.com/793-506/000-017**Item no.: 793-5501**WMB marking card; as card; for terminal block width 5 - 17.5 mm; stretchable 5 - 5.2 mm; plain; snap-on type www.wago.com/793-5501**Item no.: 793-5501/000-002**WMB marking card; as card; for terminal block width 5 - 17.5 mm; stretchable 5 - 5.2 mm; plain; snap-on type www.wago.com/793-5501/000-002**Item no.: 793-5501/000-005**WMB marking card; as card; stretchable 5 - 5.2 mm; plain; snap-on type www.wago.com/793-5501/000-005**Item no.: 793-5501/000-006**WMB marking card; as card; stretchable 5 - 5.2 mm; plain; snap-on type www.wago.com/793-5501/000-006**Item no.: 793-5501/000-007**WMB marking card; as card; stretchable 5 - 5.2 mm; plain; snap-on type www.wago.com/793-5501/000-007**Item no.: 793-5501/000-012**WMB marking card; as card; stretchable 5 - 5.2 mm; plain; snap-on type www.wago.com/793-5501/000-012

**Item no.: 793-5501/000-014**

WMB marking card; as card; stretchable 5 - 5.2 mm; plain; snap-on type

www.wago.com/793-5501/000-014**Item no.: 793-5501/000-017**

WMB marking card; as card; stretchable 5 - 5.2 mm; plain; snap-on type

www.wago.com/793-5501/000-017**Item no.: 793-5501/000-023**

WMB marking card; as card; stretchable 5 - 5.2 mm; plain; snap-on type

www.wago.com/793-5501/000-023**Item no.: 793-5501/000-024**

WMB marking card; as card; stretchable 5 - 5.2 mm; plain; snap-on type

www.wago.com/793-5501/000-024**Item no.: 793-566**

WMB marking card; as card; MARKED; 1 ... 50 (2x); not stretchable; Horizontal marking; snap-on type

www.wago.com/793-566**Item no.: 793-566/000-002**

WMB marking card; as card; MARKED; 1 ... 50 (2x); not stretchable; Horizontal marking; snap-on type

www.wago.com/793-566/000-002**Item no.: 793-566/000-005**

WMB marking card; as card; MARKED; 1 ... 50 (2x); not stretchable; Horizontal marking; snap-on type

www.wago.com/793-566/000-005**Item no.: 793-566/000-006**

WMB marking card; as card; MARKED; 1 ... 50 (2x); not stretchable; Horizontal marking; snap-on type

www.wago.com/793-566/000-006**Item no.: 793-566/000-007**

WMB marking card; as card; MARKED; 1 ... 50 (2x); not stretchable; Horizontal marking; snap-on type

www.wago.com/793-566/000-007**Item no.: 793-566/000-012**

WMB marking card; as card; MARKED; 1 ... 50 (2x); not stretchable; Horizontal marking; snap-on type

www.wago.com/793-566/000-012**Item no.: 793-566/000-017**

WMB marking card; as card; MARKED; 1 ... 50 (2x); not stretchable; Horizontal marking; snap-on type

www.wago.com/793-566/000-017**Item no.: 793-566/000-023**

WMB marking card; as card; MARKED; 1 ... 50 (2x); not stretchable; Horizontal marking; snap-on type

www.wago.com/793-566/000-023**Item no.: 793-566/000-024**

WMB marking card; as card; MARKED; 1 ... 50 (2x); not stretchable; Horizontal marking; snap-on type

www.wago.com/793-566/000-024**ferrule****Item no.: 216-241**Ferrule; Sleeve for 0.5 mm² / AWG 22; insulated; electro-tin plated; electrolytic copper; gastight crimped; acc. to DIN 46228, Part 4/09.90www.wago.com/216-241**Item no.: 216-242**Ferrule; Sleeve for 0.75 mm² / AWG 20; insulated; electro-tin plated; electrolytic copper; gastightwww.wago.com/216-242

 crimped; acc. to DIN 46228, Part 4/09.90

 **Item no.: 216-243**
 Ferrule; Sleeve for 1 mm² / AWG 18; insulated; electro-tin plated; electrolytic copper; gastight crimped; www.wago.com/216-243
 acc. to DIN 46228, Part 4/09.90

 **Item no.: 216-244**
 Ferrule; Sleeve for 1.5 mm² / AWG 16; insulated; electro-tin plated; electrolytic copper; gastight crimped; acc. to DIN 46228, Part 4/09.90 www.wago.com/216-244

General accessories

 **Item no.: 209-145**
 Group marker carrier www.wago.com/209-145

 **Item no.: 209-184**
 Protection cover www.wago.com/209-184

 **Item no.: 249-105**
 Group marker carrier www.wago.com/249-105

 **Item no.: 788-125**
 Accessories for relay modules; Operation status indicator: red www.wago.com/788-125

 **Item no.: 788-148**
 Filter module; RC filter element; Nominal voltage: 230 VAC www.wago.com/788-148

Downloads

Documentation

Bid Text

858-518 Relaisbaustein	Jan 15, 2016	DOC 29.7 kB	Download
---------------------------	--------------	----------------	----------

Instruction Leaflet

Sockets for Elementary Relays	Dec 9, 2016	PDF 2.6 MB	Download
-------------------------------	-------------	---------------	----------

Additional Information

Disposal; Electrical and electronic equipment, Packaging	Oct 15, 2018	265.8 kB	Download
--	--------------	----------	----------

smartDATA

CAD data

3D Download 858-518	URL	Download
---------------------	-----	----------



Subject to changes.

WAGO Kontakttechnik GmbH & Co. KG
Hansastr. 27
32423 Minden
Phone: +49571 887-0 | Fax: +49571 887-169
Email: info.de@wago.com | Web: www.wago.com

Do you have any questions about our products?
We are always happy to take your call at +49 (571) 887-44222.