

**Panasonic<sup>®</sup>**

**SAFETY LIGHT CURTAIN**

**SF4B Version 2**

**Instruction Manual**

---

## BEFORE BEGINNING

---

The printed English and Japanese versions of this instruction manual are the original versions.

The English, French, German, Italian and Spanish versions published in the Internet are copies of the original documentation and were produced by Panasonic Electric Works Europe AG.

### **Liability and Copyright for the Hardware**

This manual and everything described in it are copyrighted. You may not copy this manual, in whole or part, without written consent of Panasonic Electric Works Europe AG (PEWEU).

PEWEU pursues a policy of continuous improvement of the design and performance of its products. Therefore we reserve the right to change the manual/product without notice. In no event will PEWEU be liable for direct, special, incidental, or consequential damage resulting from any defect in the product or its documentation, even if advised of the possibility of such damages.

We invite your comments on this manual. Please e-mail us at:

[tech-doc@eu.pewg.panasonic.com](mailto:tech-doc@eu.pewg.panasonic.com).

Please direct support matters and technical questions to your local Panasonic representative.

## LIMITED WARRANTY

---

If physical defects caused by distribution are found, PEWEU will replace/repair the product free of charge. Exceptions include:

- When physical defects are due to different usage/treatment of the product other than described in the manual.
- When physical defects are due to defective equipment other than the distributed product.
- When physical defects are due to modifications/repairs by someone other than PEWEU.
- When physical defects are due to natural disasters.

# Important Symbols

---

One or more of the following symbols may be used in this documentation:



## **DANGER!**

The warning triangle indicates especially important safety instructions. If they are not adhered to, the results could be fatal or critical injury.



## **CAUTION**

---

---

Indicates that you should proceed with caution. Failure to do so may result in injury or significant damage to instruments or their contents, e.g. data.



## **NOTE**

---

---

Contains important additional information.



## **EXAMPLE**

---

---

Contains an illustrative example of the previous text section.



## **Procedure**

---

---

Indicates that a step-by-step procedure follows.



## **REFERENCE**

---

---

Indicates where you can find additional information on the subject at hand.



---

**◆ KEY POINTS**

---

Summarizes key points in a concise manner.



---

**◆ SHORTCUTS**

---

Provides helpful keyboard shortcuts.



---

**◆ EXPLANATION**

---

Provides a brief explanation of a function, e.g. why or when you should use it.

➔ next page

Indicates that the text will be continued on the next page.

# Table of Contents

<b>1. Introduction.....</b>	<b>1</b>
1.1 Target Group.....	2
1.2 Safety Instructions .....	3
1.3 Applicable Standards/Regulations .....	6
<b>2. Before Using the Device .....</b>	<b>7</b>
2.1 Features.....	8
2.2 Confirmation of Packed Contents .....	9
2.3 Part Description .....	10
2.3.1 How the Display Works .....	11
2.4 Protection Area .....	15
2.4.1 Sensing Area .....	15
2.4.2 Safety Distance .....	16
2.4.2.1 Calculation Example for Europe.....	19
2.4.2.2 Calculation Example for the US .....	22
2.4.3 Influence of Reflective Surfaces.....	24
2.4.4 Placement of Emitter and Receiver.....	25
2.5 Mounting .....	27
2.5.1 Mounting of the Mounting Bracket.....	27
2.5.1.1 Standard Mounting Bracket MS-SFB-1.....	28
2.5.1.2 Intermediate Supporting Bracket MS-SFB-2.....	30
2.5.1.3 Dead Zoneless Mounting Bracket MS-SFB-3 .....	32
2.5.1.4 Protect-Bar Mounting Bracket MC-SFBH-□-T.....	33
2.5.2 Mounting of the Bottom Cap Cable .....	34

2.5.3	Mounting and Dismantling of a Series Connection .....	36
2.6	Wiring .....	39
2.6.1	PNP Output .....	40
2.6.2	NPN Output .....	42
2.6.3	Power Supply Unit .....	43
2.6.4	Output Signal during Self-Diagnosis .....	44
2.6.5	Connecting Procedure and Connector Pin Assignment.....	44
2.6.6	Basic Wiring.....	46
2.6.7	Wiring Examples.....	48
2.6.7.1	Manual Reset When Interlock is Activated (Control Category 4)....	48
2.6.7.2	Series Connection (Control Category 4) .....	51
2.6.7.3	Parallel Connection (Control Category 4) .....	54
2.6.7.4	Mixed Connection (Control Category 4).....	58
2.6.7.5	Auto-Reset (Control Category 4).....	62
2.6.7.6	External Device Monitor Function Deactivated (Control Category 4) 64	
2.6.7.7	Muting Function (Control Category 4).....	66
2.7	Adjustment.....	69
2.7.1	Beam-Axis Alignment .....	69
2.7.2	Operation Test.....	71
<b>3.</b>	<b>Functions .....</b>	<b>73</b>
3.1	Self-Diagnosis Function.....	74
3.2	Interlock Function .....	75
3.3	Emission Halt Function.....	76
3.4	Interference Prevention Function .....	77
3.5	Auxiliary Output (Non-Safety Output).....	78
3.6	External Device Monitor Function.....	79
3.7	Muting Function .....	81
3.7.1	Specification for the Muting Sensor.....	82

---

3.7.2	Installation of the Muting Sensor .....	83
3.8	Override Function .....	85
3.9	Functions of the Optional Handy Controller SFB-HC.....	88
<b>4.</b>	<b>Operation.....</b>	<b>91</b>
4.1	Normal Operation.....	92
4.2	Using the Emission Halt Function .....	99
4.3	When an Error Occurs .....	102
<b>5.</b>	<b>Maintenance.....</b>	<b>105</b>
5.1	Daily Inspection Checklist .....	106
5.2	Periodic Inspection Checklist (Every Six Months).....	108
5.3	Inspection after Maintenance.....	109
<b>6.</b>	<b>Troubleshooting .....</b>	<b>111</b>
6.1	Emitter-Related Problems .....	112
6.1.1	All Indicators Are OFF .....	112
6.1.2	Fault Indicator (Yellow) Lights up or Blinks .....	112
6.1.3	Setting Indicator Lights Up // Emitter.....	113
6.1.4	Emission Halt Indicator (Orange) Lights Up.....	113
6.1.5	All Beam-axis Adjustment Indicators (Red) Light Up .....	114
6.1.6	Operation Indicator Remains Lit in Red .....	114
6.2	Receiver-Related Problems .....	115
6.2.1	All Indicators Are OFF .....	115
6.2.2	Fault Indicator (Yellow) Lights up or Blinks .....	115
6.2.3	Digital Error Indicator "C" Lights Up .....	117
6.2.4	All Beam-axis Adjustment Indicators (Red) Light Up .....	117

6.2.5	Operation Indicator Remains Lit in Red .....	117
<b>7.</b>	<b>Specifications .....</b>	<b>119</b>
7.1	Specifications by Model Numbers .....	120
7.1.1	Model Numbers SF4B-Fxx<V2> with 10mm Beam Pitch .....	120
7.1.2	Model Numbers SF4B-Hxx<V2> with 20mm Beam Pitch .....	121
7.1.3	Model Numbers SF4B-Axx<V2> with 40mm Beam Pitch .....	122
7.2	Common Specifications.....	124
7.3	Options .....	127
7.3.1	Front Protection Cover .....	127
7.3.2	Cables.....	128
7.3.2.1	Bottom Cap Cables .....	128
7.3.2.2	Extension Cable with Connector on One End.....	129
7.3.2.3	Extension Cable with Connectors on Both Ends.....	129
7.3.2.4	Cable for Series Connection .....	130
7.3.2.5	Cable for Application Expansion Unit SF-C14EX.....	130
7.3.2.6	Cables for PNP/NPN Output .....	130
7.3.3	Brackets.....	130
7.3.3.1	Standard Mounting Bracket (M5) .....	131
7.3.3.2	360° Rotatable Mounting Bracket (M8).....	131
7.3.3.3	M8 Rear Mounting Bracket.....	131
7.3.3.4	M8 Side Mounting Bracket .....	131
7.3.3.5	M8 Rear / Side Mounting Bracket Set.....	132
7.3.3.6	M5 Pitch Adapter Bracket.....	132
7.3.3.7	M8 Pitch Adapter Bracket.....	133
7.3.3.8	Dead Zoneless Mounting Bracket .....	133
7.3.4	Handy Controller.....	134
7.3.5	Laser Alignment Tool for Light Curtain.....	134
7.3.6	Control Units.....	135
7.3.6.1	Unit with Connectors .....	135
7.3.6.2	Unit for Demanding Industrial Environments.....	135
7.3.6.3	Miniature Unit .....	136



---

7.3.6.4	Application Expansion Unit.....	136
7.3.7	Protect Bar.....	137
7.3.8	Test Rod .....	138
<b>8.</b>	<b>Dimensions .....</b>	<b>139</b>
8.1	Mounting Dimensions .....	140
8.1.1	Mounting with Rear Mounting Bracket (MS-SFB-7-T).....	140
8.1.2	Mounting with Side Mounting Bracket (MS-SFB-8-T) .....	142
8.1.3	Rear Mounting with Dead Zoneless Mounting Bracket (MS-SFB-3).....	144
8.1.4	Side Mounting with Dead Zoneless Mounting Bracket (MS-SFB-3) .....	146
8.2	Mounting Bracket Dimensions .....	148
8.2.1	Standard Mounting Bracket (MS-SFB-1).....	148
8.2.2	M8 360° Rotatable Mounting Bracket (MS-SFB-1-T).....	149
8.2.3	Rear Mounting Bracket (MS-SFB-7-T).....	149
8.2.4	Side Mounting Bracket (MS-SFB-8-T).....	150
8.2.5	M5 Pitch Adapter Bracket (MS-SFB-4) .....	151
8.2.6	M8 Pitch Adapter Bracket (MS-SFB-4-T).....	151
8.2.7	Intermediate Supporting Bracket (MS-SFB-2) .....	152
8.2.8	Dead Zoneless Mounting Bracket (MS-SFB-3).....	152

# Chapter 1

---

## Introduction

## 1.1 Target Group

---

Thank you for purchasing the Safety Light Curtain from the SF4B series (hereinafter called 'this device'). Please read this instruction manual carefully and thoroughly for the correct and optimum use of this product. Kindly keep this manual in a convenient place for quick reference.

This device is a light curtain for protecting a person from dangerous parts of a machine which can cause injury or accident.

This manual has been written for the following personnel who:

- have undergone suitable training and have knowledge of light curtains as well as safety systems and standards.
- who are responsible for the introduction of this device
- who design systems using this device
- who install and connect this device
- who manage and operate a plant using this device

### **Machine designer, installer, employer and operator**

The machine designer, installer, employer and operator are solely responsible for ensuring that all applicable legal requirements relating to the installation and the use in any application are satisfied and all instructions for installation and maintenance contained in the instruction manual are followed.

Whether this device functions as intended and systems including this device comply with safety regulations depend on the appropriateness of the application, installation, maintenance and operation. The machine designer, installer, employer and operator are solely responsible for these items.

### **Engineer**

The engineer must be a person who is appropriately trained, has widespread knowledge and experience, and can solve various problems which may arise in his field of work, e.g. as a machine designer or a person in charge of installation or operation, etc.

### **Operator**

The operator should read this instruction manual thoroughly, understand its contents, and perform operations following the procedures described in this manual for the correct operation of this device.

In case this device does not perform properly, the operator should report this to the person in charge and stop machine operation immediately. The machine must not be used until correct performance of this device has been confirmed.

## 1.2 Safety Instructions

---

- Use this device as per its specifications. Do not modify this device since its functions and capabilities may not be maintained and it may malfunction.
- This device has been developed/produced for industrial use only.
- Do not use this device under conditions or in environments not described in this manual. Please consult us if there is no other choice but to use this device in such an environment.
- Do not use this device in fields such as nuclear power control, railroad, aircraft, automobiles, combustion facilities, medical systems, aerospace development, etc.
- When this device is to be used for enforcing protection of a person from any danger occurring around an operating machine, the user must satisfy the regulations established by national or regional security committees.
- In case of applying this device to particular equipment, follow the safety regulations in regard to appropriate usage, mounting (installation), operation and maintenance.
- Use this device by installing suitable protection equipment as a countermeasure for failure, damage, or malfunction of this device.
- Before using this device, check whether the device performs properly and has the functions and capabilities as stated in the design specifications.
- Dispose of this device as industrial waste.

### Environment

- Do not use a mobile phone or a radio phone near this device.
- If the device is installed in a place where there are reflective surfaces, make sure to install this device so that reflected light from the reflective surfaces does not affect the receiver. Alternatively, take countermeasures such as painting, masking, roughening, or changing the material of the reflective surfaces, etc. Failure to do so may cause the sensor not to detect properly, which may result in death or serious injury.
- Do not install this device in the following environments.
  - Areas exposed to intense interference light such as direct sunlight
  - Areas with high humidity where condensation is likely to occur
  - Areas exposed to corrosive or explosive gases
  - Areas exposed to vibration or shock at levels higher than those specified
  - Areas exposed to contact with water
  - Areas exposed to too much steam or dust
  - Areas where the beam-receiving part of this device is directly exposed to light from a high-frequency fluorescent lamp (inverter type) or rapid-starter fluorescent lamp.

## Installation

- **Always keep the correctly calculated safety distance between this device and the dangerous parts of the machine.**
- **Install an extra protection structure around the machine so that the operator must pass through the sensing area of this device to reach the dangerous parts of the machine.**
- **Install this device in a manner that some part of the operator's body always remains in the sensing area until the operator has finished working with the dangerous parts of the machine.**
- **Do not install this device at a location where it can be affected by wall reflection.**
- **When installing multiple sets of this device, connect the sets and, if necessary, install some barriers so that mutual interference does not occur.**
- **Do not use this device in an environment with reflective light.**
- **The corresponding emitter and receiver must have the same serial number and be correctly oriented.**

## Equipment in which this device is installed

- **When this device is used in the PSDI (see page 154) mode, an appropriate control circuit must be configured between this device and the machinery. For details, be sure to refer to the standards or regulations applicable in each region or country.**
- **In Japan, do not use this device as safety equipment for a press machine or a shearing machine.**
- **Do not install this device with a machine whose operation cannot be stopped immediately in the middle of an operation cycle by an emergency stop.**
- **This device provides safety 2 seconds after the power has been switched ON. Make sure that the control system takes the time delay into consideration.**

## Wiring

- **Switch off the power before wiring the device.**
- **All electrical wiring should conform to the regional electrical regulations and laws. The wiring should be done by engineer(s) having the required electrical knowledge.**
- **Do not run the sensor cable together with high-voltage lines or power lines or put them together in the same raceway.**
- **In case you need to extend the cable of the emitter or the receiver, you can use the dedicated extension cable. The cable can be extended up to 50m. However, if the cable is extended in an installation with multiple sensors connected in series or with the muting lamp (see page 81), the total extendable length of the cable depends on the number of the sensors connected in series (see page 44).**

- **When this device is used in Korea as a product conforming to the Korean S-mark, the power line cable connected to this device should be no longer than 10m.**
- **Do not control the device at only one control output (OSSD 1, OSSD 2).**
- **When this device is used in Korea in an installation with multiple sensors connected in series in conformity with the Korean S-mark, make sure to ground the device on the 0V side (PNP output).**

#### **Maintenance**

- **When you need to replace parts, always use only genuine replacement parts from the supplier. If you use substitute parts from another manufacturer, the sensor may fail to detect properly, which may result in death or serious body injury.**
- **The device must be inspected periodically by an engineer with the required knowledge.**
- **When you have adjusted or maintained the device, test the device following the procedure specified in the maintenance (see page 109) chapter before you switch the system back on.**
- **Clean this device with a clean cloth. Do not use thinner-based cleaners.**

#### **Others**

- **Never modify this device. When you modify the device, the sensor may fail to detect properly, which may result in death or serious body injury.**
- **Do not use this device to detect objects flying over the sensing area.**
- **Do not use this device to detect transparent objects, translucent objects or objects smaller than the specified minimum sensing size.**



## 1.3 Applicable Standards/Regulations

This device complies with the following standards/regulations.

- EU Machinery Directive 2006/42/EC (valid from December 29, 2009)
- EU Machinery Directive 98/37/EC (valid until December 28, 2009), EMC Directive 89/336/EEC
- EN 61496-1 (Type 4), EN 55011, EN 954-1 (Category 4)
- IEC 61496-1/2 (Type 4), ISO 13849-1: 2006 (Category 4, PL<sub>e</sub>), IEC 61508-1~7 (SIL3)
- JIS B 9704-1/2 (Type 4), JIS B 9705-1 (ISO 13849-1) (Category 4)
- UL 61496-1/2 (Type 4), UL 1998, UL 508, CSA C22.2 No.14, CSA C22.2 No.0.8
- OSHA 1910.212, OSHA 1910.217(C), ANSI B11.1 to B11.19, ANSI/RIA 15.06
- GB 4584
- The S-mark certificate has been certified by Korea Occupational Safety & Health Agency (KOSHA).



### ◆ NOTE

- The conformity to JIS, OSHA and ANSI for this device has been evaluated by ourselves.
-  : The C-CL US Listing Mark indicates compliance with both Canadian and U.S. requirements.
-  : This device conforms to the EMC directive and the Machinery directive. The CE mark on the safety light curtain indicates that this product conforms to the EMC directive.
-  : The S-mark on the safety light curtain indicates that this device has the S-mark certificate.
- If you want to use this device in a location other than the locations described above, confirm first that the intended use complies with the standards or regulations applicable in your region or country.

## **Chapter 2**

---

### **Before Using the Device**



## 2.1 Features

---

This device is a light curtain with the following features.

- No special controller is required.
- Control output (OSSD 1, OSSD 2) is available with PNP or NPN output.
- Includes beam-axis alignment indicators which make beam-axis alignment easy.
- Function setting possible with handy controller SFB-HC (optional) (see page 88).
- Many accessories (see page 127).

## 2.2 Confirmation of Packed Contents

Check mark	Number		Package content
<input type="checkbox"/>	each 1 piece		Sensor: EMITTER, RECEIVER
<input type="checkbox"/>	1 piece		Test Rod For SF4B-F□<V2>: SF4B-TR14 (ø 14 x 220mm) For SF4B-H□<V2>: SF4B-TR25 (ø 25 x 220mm)
<input type="checkbox"/>	0 to 3 sets		Intermediate Supporting Bracket (MS-SFB-2) Note: The intermediate support bracket (MS-SF4B-2) is enclosed with the following devices. The quantity differs depending on the device as shown below:
		1 set	SF4B-F□<V2>: 79 to 111 beam channels SF4B-H□<V2>: 40 to 56 beam channels SF4B-A□<V2>: 20 to 28 beam channels
		2 sets	SF4B-F127□<V2>, SF4BH□<V2>: 64 to 80 beam channels SF4B-A□<V2>: 32 to 40 beam channels
		3 sets	SF4B-H□<V2>: 88 to 96 beam channels SF4B-A□<V2>: 44 to 48 beam channels
<input type="checkbox"/>	1 piece		Instruction Manual (this manual)

## 2.3 Part Description

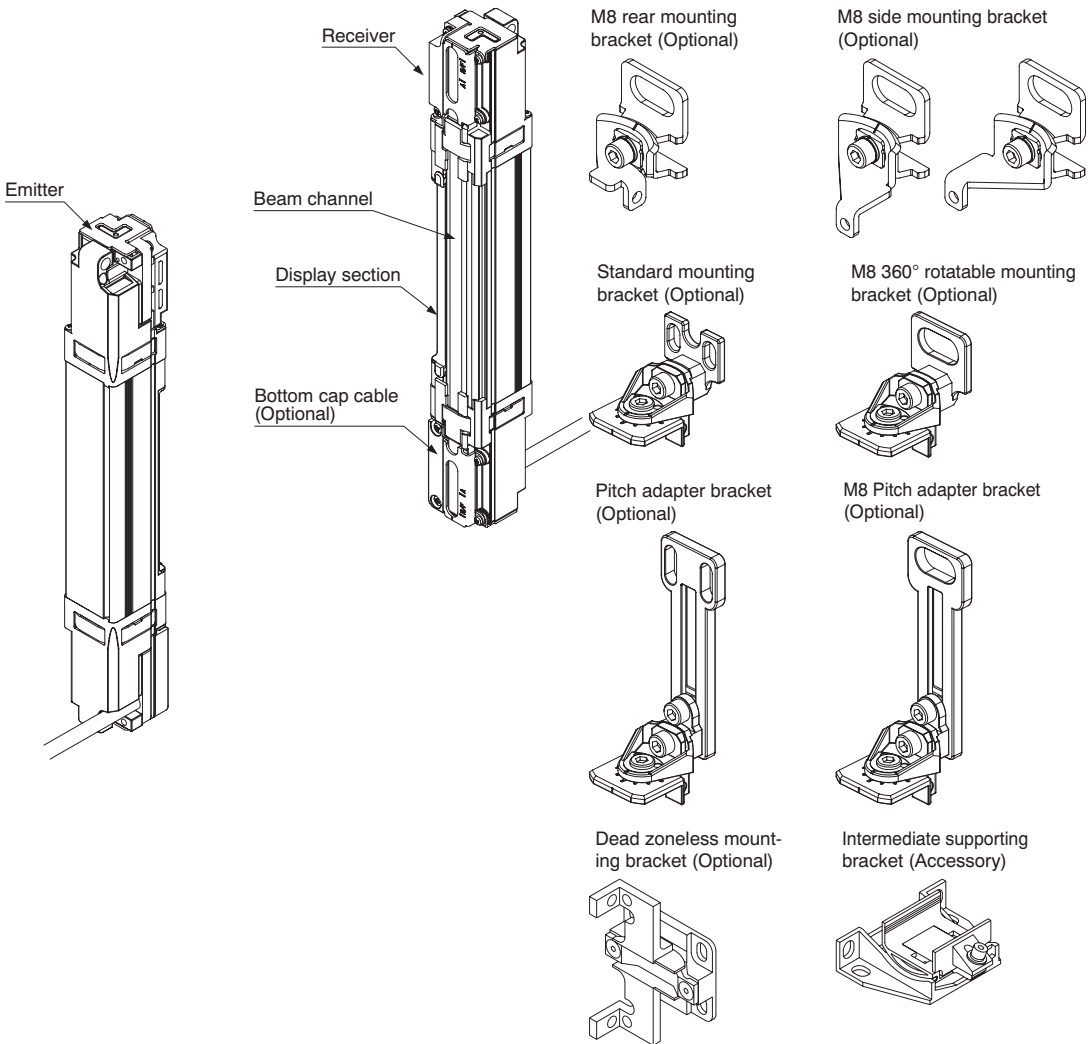

Parts of the safety light curtain

Part	Description
<b>Emitter</b>	Emits light to the receiver facing it. Furthermore, the status of the emitter is indicated on its display section.
<b>Receiver</b>	Receives light from the emitter facing it. Simultaneously the control output (OSSD 1, OSSD 2) turns ON when the all beam channels receive light from the emitter, and the control output (OSSD 1, OSSD 2) turns OFF when one or more beam channels are blocked. The receiver displays its status on the display section.
<b>Beam channel</b>	The light-emitting elements of the emitter and the light-receiving elements of the receiver are placed at the following intervals: 10mm (SF4B-F□), 20mm (SF4B-H□), and 40mm (SF4B-A□).
<b>Standard mounting bracket (optional)</b>	Use this bracket to mount the emitter/receiver. The standard mounting bracket allows you to adjust the horizontal mounting angle to any angle.

Part	Description
<b>M8 rear mounting bracket (optional)</b>	This allows the light curtain to be mounted at the rear with one M8 hexagon-socket-head bolt. The horizontal angle can be adjusted.
<b>M8 side mounting bracket (optional)</b>	This allows the light curtain to be mounted at the side with one M8 hexagon-socket-head bolt. The horizontal angle can be adjusted.
<b>M8 360° rotatable mounting bracket (optional)</b>	This allows the light curtain to be mounted at the rear with one M8 hexagon-socket-head bolt. The horizontal angle can be adjusted to any angle.
<b>Pitch adapter bracket (optional)</b>	This bracket is used when you change from a previous light curtain with a sensing height of 200 to 750mm to this device. The bracket is installed using two M5 hexagon-socket-head bolts. The horizontal angle can be adjusted.
<b>M8 pitch adapter bracket (optional)</b>	This bracket is used when you change from a previous light curtain with a sensing height of 200 to 750mm to this device. The bracket is installed using two M8 hexagon-socket-head bolts. The horizontal angle can be adjusted.
<b>Dead zoneless mounting bracket (optional)</b>	This bracket is used for mounting both the emitter and the receiver. This bracket is useful for mounting the sensor when mounting space is limited.
<b>Intermediate supporting bracket (Accessory)</b>	Use this bracket in the following situations: Mounting SF4B-F□ with more than 79 beam channels, SF4B-H□ with more than 40 beam channels or for SF4B-A□ with more than 20 beam channels.









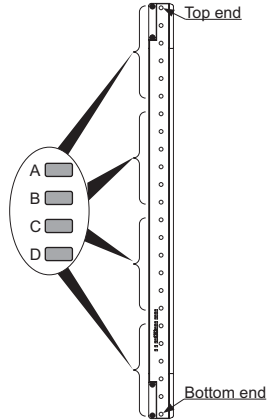

**◆ NOTE**

- In case of using the muting function, the following items are required: **12-core bottom cap cable (SFB-CB05-MU, SFB-CCB□-MU) (optional), muting sensor and muting lamp. Please purchase these items separately.**
- **The blanking function is set with the handy controller SFB-HC (optional). Please purchase the handy controller separately.**

**2.3.1 How the Display Works**

The description given in [ ] is marked on the sensor.

Emitter		
Function	Description	
<b>Beam-axis alignment indicator (red/green) [RECEPTION]</b>	When the top block receives light: lights up red When the top end receives light: blinks red When the control output (OSSD 1, OSSD 2) is ON: lights up green	<input type="checkbox"/> A
	When the upper middle block receives light: lights up red When the control output (OSSD 1, OSSD 2) is ON: lights up green	<input type="checkbox"/> B
	When the lower middle block receives light: lights up red When the control output (OSSD 1, OSSD 2) is ON: lights up green	<input type="checkbox"/> C

Emitter		
Function	Description	
	When the bottom block receives light: lights up red When the bottom end receives light: blinks red When the control output (OSSD 1, OSSD 2) is ON: lights up green	
<b>Operation indicator [OSSD] (red/green), note 1</b>	Lights up when the sensor operation is as follows (OSSD 1, OSSD 2): When the control output (OSSD 1, OSSD 2) is OFF: lights up red When the control output (OSSD 1, OSSD 2) is ON: lights up green	
<b>Incident beam intensity indicator [STB] (orange/green), notes 2 and 3</b>	When sufficient light is received (incident beam: 130% or more): lights up green When stable light is received (incident beam: 115 to 130%): OFF When unstable light is received (incident beam: 100 to 115%): lights up orange When light is blocked: OFF	
<b>Fault indicator [FAULT] (yellow)</b>	When a fault occurs in the sensor: lights up or blinks	
<b>Digital error indicator (red)</b>	When the safety light curtain is in the lockout state, the error contents are displayed here.	
<b>PNP indicator [PNP] (orange)</b>	When the PNP output is set: lights up	
<b>NPN indicator [NPN] (orange)</b>	When the NPN output is set: lights up	
<b>Emission intensity control indicator [CTRL] (orange)</b>	When light is emitted in short mode: lights up When light is emitted in normal mode: OFF	
<b>Emission halt indicator [Halt] (orange)</b>	When light emission is halted: lights up When light is emitted: OFF	







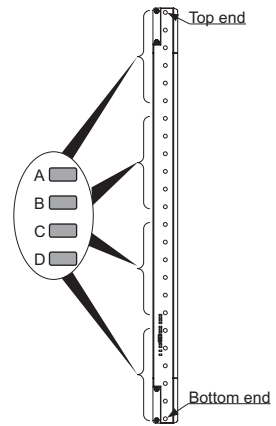

◆ **NOTE**

1. Since the color of the operation indicator changes according to whether the control output (OSSD 1, OSSD 2) is ON or OFF, the operation indicator on the sensor is marked "OSSD".
2. The threshold where the control output (OSSD 1, OSSD 2) changes from OFF to ON is applied as "100% incident light intensity".
3. The status "when light is blocked" refers to the status when there is an obstacle in the sensing area.

The description given in [ ] is marked on the sensor.

Receiver		
Function	Description	
<b>Beam-axis alignment indicator (red/green) [RECEPTION]</b>	When the top block receives light: lights up red When the top end receives light: blinks red When the control output (OSSD 1, OSSD 2) is ON: lights up green	<input type="checkbox"/> A
	When the upper middle block receives light: lights up red When the control output (OSSD 1, OSSD 2) is ON: lights up green	<input type="checkbox"/> B
	When the lower middle block receives light: lights up red When the control output (OSSD 1, OSSD 2) is ON: lights up green	<input type="checkbox"/> C
	When the bottom block receives light: lights up red When the bottom end receives light: blinks red When the control output (OSSD 1, OSSD 2) is ON: lights up green	<input type="checkbox"/> D
<b>OSSD indicator [OSSD] (red/green), note 1</b>	When the control output (OSSD 1, OSSD 2) is OFF: lights up red When the control output (OSSD 1, OSSD 2) is ON: lights up green	<input type="checkbox"/>
<b>Incident beam intensity indicator [STB] (orange/green), notes 2 and 3</b>	When sufficient light is received (incident beam: 130% or more): lights up green When stable light is received (incident beam: 115 to 130%): OFF When unstable light is received (incident beam: 100 to 115%): lights up orange When light is blocked: OFF	<input type="checkbox"/>



Receiver			
Function	Description		
<b>Fault indicator [FAULT] (yellow)</b>	When a fault occurs in the sensor: lights up or blinks		
<b>Digital error indicator (red)</b>	When device goes into lockout condition, error contents are displayed here.		
<b>PNP indicator [PNP] (orange)</b>	When the PNP output is set: lights up		
<b>NPN indicator [NPN] (orange)</b>	When the NPN output is set: lights up		
<b>Function setting indicator [FUNCTION], note 4</b>	When blanking function is used: lights up When connecting the handy controller: blinks		
<b>Interlock indicator [INTERLOCK]</b>	When the safety light curtain is interlocked: lights up In all other cases: OFF		



**◆ NOTE**

1. Since the color of the operation indicator changes according to whether the control output (OSSD 1, OSSD 2) is ON or OFF, the operation indicator on the sensor is marked "OSSD".
2. The threshold where the control output (OSSD 1, OSSD 2) changes from OFF to ON is applied as "100% incident beam intensity".
3. The status "when the light is blocked" means there is an obstacle in the sensing area
4. The blanking function is set by using the handy controller SFB-HC (optional). Please purchase the handy controller separately.

## 2.4 Protection Area

### 2.4.1 Sensing Area

The sensing area is the zone formed by the sensing height of the sensor and the sensing range between the emitter and the receiver. The sensing height is determined by the number of beam channels. The sensing range depends on the device type: 0.3 to 9m for SF4B-H□ (12 to 64 beam channels) and SF4B-A□ (6 to 32 beam channels), 0.3 to 7m for SF4B-F□ and SF4B-H□ (72 to 96 beam channels) as well as SF4B-A□ (36 to 48 beam channels). Remember that the sensing range becomes shorter when you mount a protection cover (FC-SFBH-□) (optional). Also remember that if the sensing range is less than 0.3m, malfunction may occur due to the optical structure.

#### Sensing height, sensing range, and sensing area

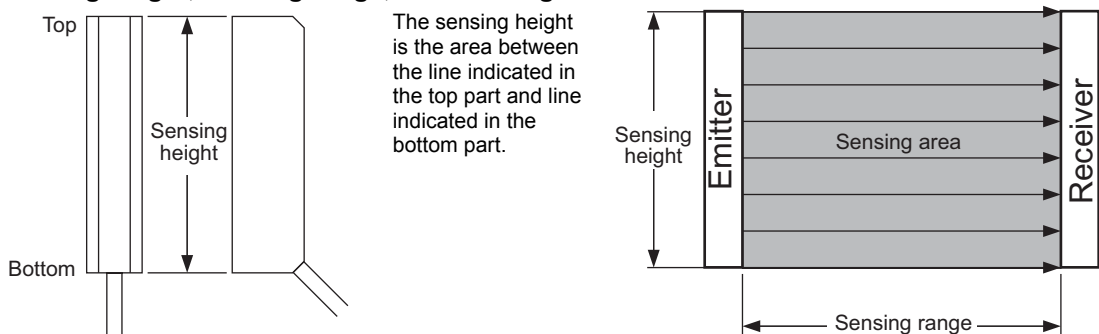

#### **DANGER!**

**Do not use any arrangement using reflection or recursive reflection.**

**Follow the below descriptions carefully. Failure to do so may result in serious injury or death.**

Install a protective structure around the machine so that the operator must pass through the sensing area of this device to reach the dangerous parts of the machine. Furthermore, ensure that some part of the operator's body always remains in the sensing area while the operator works on the dangerous parts of the machine.

When connecting the sensor, use the correct combination of emitter and receiver (same beam pitch and number of beam channels) and match their top-bottom orientation. Combining different types of emitters and receivers may produce a non-sensing area.



Do not arrange several receivers facing one emitter, or vice versa, as this could produce a non-sensing area or cause mutual interference.



**◆ EXAMPLE**

**Correct installation**

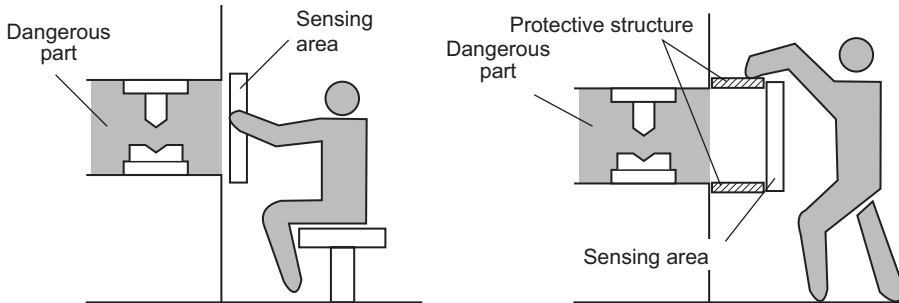

**Incorrect installation**

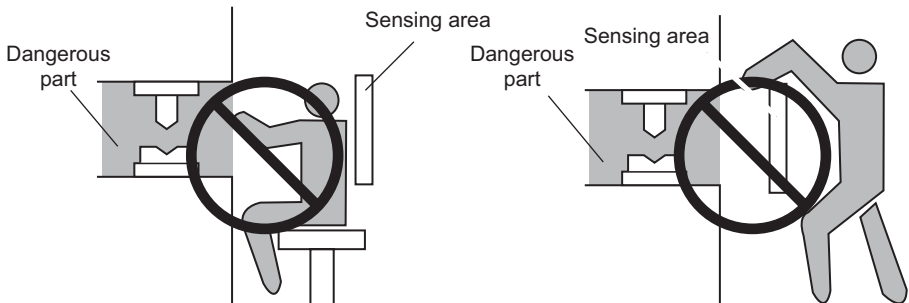

**2.4.2 Safety Distance**



**DANGER!**

**Calculate the safety distance correctly and always maintain a distance equal to or greater than the safety distance between the sensing area of this device and the dangerous parts of the machine. If the safety distance is miscalculated or not sufficient, the machine will not stop quickly enough when a human body or an object reaches the dangerous parts, which may result in serious injury or death.**

The safety distance is the minimum distance that must be maintained between the light curtain and the dangerous parts of the machine so that the machine can be stopped before a human body or an object can reach the dangerous parts.

The safety distance is calculated based on the equation described on the next page when a person moves (normal intrusion) at a straight angle into the sensing area of the sensor.

In case the intrusion direction is not perpendicular to the sensing area, be sure to refer to the relevant standard for details of the calculation (regional standard, specification of the machine etc.)

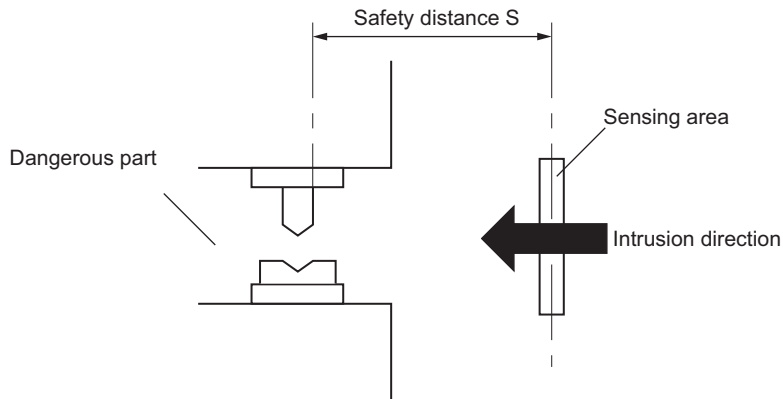

*Safety distance*



## **DANGER!**

Before designing the system, refer to the relevant standards of the region where this device is to be used and then install this device. Furthermore, the equation described on the next pages is to be used only when the intrusion direction is perpendicular to the sensing area, i.e. at a straight angle. If the intrusion direction is not perpendicular to the sensing area, refer to the relevant standard (regional standard, specification of the machine, etc.) for details of the calculation.

The max. response time of the machine is from the point when the machine receives the halt signal from this device to the point when the dangerous part of the machine stops. The max. response time of the machine should be timed with the actual machine.

The minimum size of the objects to be detected by the safety light curtain varies depending on whether the floating blanking function (see page 88) is used or not. The equation differs depending on the case whether the minimum sensing object is larger than  $\varnothing 40\text{mm}$  or not. Calculate the safety distance with the correct minimum size and the appropriate equation.

	Minimum size of the object			
	Floating blanking not active	Floating blanking active at (Note)		
		1 beam channel	2 beam channels	3 beam channels
<b>SF4B-F</b> (10mm beam channel pitch type)	$\varnothing 14\text{mm}$	$\varnothing 24\text{mm}$	$\varnothing 34\text{mm}$	$\varnothing 44\text{mm}$
<b>SF4B-H</b> (20mm beam channel pitch type)	$\varnothing 25\text{mm}$	$\varnothing 45\text{mm}$	$\varnothing 65\text{mm}$	$\varnothing 85\text{mm}$
<b>SF4B-A</b> (40mm beam channel pitch type)	$\varnothing 45\text{mm}$	$\varnothing 85\text{mm}$	$\varnothing 125\text{mm}$	$\varnothing 165\text{mm}$



**◆ NOTE**

**When the safety light curtain is used in the PSDI mode, an appropriate safety distance S must be calculated. For details, refer to the standards or regulations applicable in your region or country.**

### 2.4.2.1 Calculation Example for Europe

The equation for the safety distance S is calculated in accordance with EN 999 and ISO 13855.

#### Formula in case that the minimum sensing object is Ø40mm or less:

$$S = K \times T + C$$

S: Safety distance (mm)

Minimum distance required between the sensing area surface and the dangerous parts of the machine.

K: Intrusion velocity of operator's body or object (mm/s). The equation assumes an intrusion direction perpendicular to the sensing area.

T: Response time of total equipment (s).  $T = T_m + T_{SF4B}$

$T_m$ : Maximum halt time of device (s). For determining  $T_m$ , refer to the machine documentation or take a measurement using a special device called a 'brake monitor'.

$T_{SF4B}$ : Response time of this device (s)

C: Additional distance calculated from the minimum size of the object to be detected by the sensor (mm). C has to be 0 or more.  $C = 8 \times (d - 14)$

d: Minimum object diameter (mm)



#### ◆ Procedure

##### 1. Calculate the safety distance S with a velocity $K = 2,000\text{mm/s}$

There are 3 possibilities (1-3):

1.  $S < 100\text{mm}$

Use 100mm as the safety distance.

2.  $100 \leq S \leq 500\text{mm}$

Use the calculated result as the safety distance.

3.  $S > 500\text{mm}$

Continue with the next step in the procedure

##### 2. Recalculate S with $K' = 1,600\text{mm/s}$

There are 2 possibilities (4-5):

4.  $S > 500\text{mm}$

Use the calculated result as the safety distance.

5.  $S \leq 500\text{mm}$

Use 500mm as the safety distance.



### ◆ EXAMPLE

Calculate the safety distance with the following values:

K: 2,000mm/s

$T_m$ : 0.1s

$T_{SF4B}$ : 14ms

d: 14mm

With these values, the calculation is as follows:

$$\begin{aligned}
 S &= K \times T + C \\
 &= K \times (T_m + T_{SF4B}) + 8 \times (d - 14) \\
 &= 2,000 \times (0.1 + 0.014) + 8 \times (14 - 14) \\
 &= 228
 \end{aligned}$$

As 228 matches possibility 2 listed above, **228mm** is the safety distance.



### ◆ EXAMPLE

Calculate the safety distance with the following values:

K: 2,000mm/s

$T_m$ : 0.4s

$T_{SF4B}$ : 14ms

d: 14mm

With these values, the calculation is as follows:

$$\begin{aligned}
 S &= K \times T + C \\
 &= K \times (T_m + T_{SF4B}) + 8 \times (d - 14) \\
 &= 2,000 \times (0.4 + 0.014) + 8 \times (14 - 14) \\
 &= 828
 \end{aligned}$$

As 828 matches possibility 3 listed above, recalculate the safety distance with  $K' = 1,600\text{mm/s}$ .

$$\begin{aligned}
 S &= K' \times T + C \\
 &= K \times (T_m + T_{SF4B}) + 8 \times (d - 14) \\
 &= 1,600 \times (0.4 + 0.014) + 8 \times (14 - 14) \\
 &= 662.4
 \end{aligned}$$

As 662.4 is > 500mm, use this recalculated result as the safety distance.

**Formula in case that the minimum sensing object is Ø40mm or more:**

$$S = K \times T + C$$

S: Safety distance (mm)

Minimum distance required between the sensing area surface and the dangerous parts of the machine.

K: Intrusion velocity of operator's body or object (mm/s). The equation assumes an intrusion direction perpendicular to the sensing area.

T: Response time of total equipment (s).  $T = T_m + T_{SF4B}$

$T_m$ : Maximum halt time of device (s). For determining  $T_m$ , refer to the machine documentation or take a measurement using a special device called a 'brake monitor'.

$T_{SF4B}$ : Response time of this device (s)

C: Additional distance calculated from the minimum size of the object to be detected by the sensor (mm).  $C = 850$  mm (Constant)

### 2.4.2.2 Calculation Example for the US

The equation safety distance S is calculated in accordance with ANSI B11.19 with the formula:

$$S = K \times (T_s + T_c + T_{SF4B} + T_{bm}) + D_{pf}$$

- S:** Safety distance (mm)  
Minimum distance required between the sensing area surface and the dangerous parts of the machine.
- K:** Intrusion velocity of operator's body or object. The recommended value in OSHA is 63inch/s  $\approx$  1,600mm/s.  
ANSI B11.19 does not define the intrusion velocity 'K'. When determining K, consider possible factors including the physical ability of operators.
- T<sub>bm</sub>** Additional halting time tolerance for the brake monitor (s)  
 $T_{bm} = T_a - (T_s + T_c)$   
**T<sub>a</sub>:** Setting time of brake monitor (s)  
When the machine is not equipped with a brake monitor, it is recommended that 20% or more of (T<sub>s</sub> + T<sub>c</sub>) is taken as additional halt time.  
**T<sub>s</sub>:** Halt time calculated from the operation time of the control element (air valve, etc.) (s)  
**T<sub>c</sub>:** Maximum response time of the control circuit required for the brake (s)
- T<sub>SF4B</sub>** Response time of this device (s)
- D<sub>pf</sub>** Additional distance calculated from the minimum size of the object to be detected by the safety light curtain (mm) with the formula:  
 $D_{pf} = 3.4 \times (d - 0.276) \text{ inch} \approx 3.4 \times d - 7\text{mm}$   
SF4B-F□ D<sub>pf</sub> = 23.8mm for minimum object diameter 0.552inch  $\approx$  14mm  
SF4B-H□ D<sub>pf</sub> = 61.2mm for minimum object diameter 0.985inch  $\approx$  25mm  
SF4B-A□ D<sub>pf</sub> = 129.2mm for minimum object diameter 1.772inch  $\approx$  45mm



#### ◆ NOTE

- The value of D<sub>pf</sub> cannot be 0 or less.
- When the floating blanking function is used, the minimum size of the object to be detected becomes larger. According to ANSI B11.1, D<sub>pf</sub> = 900mm (3ft) when d > 64mm (2.5 inches).

- Since the calculation above is performed by taking 1 inch = 25.4mm, there is a slight difference between the representation in mm and that in inches. Refer to the relevant standard for details.



### ◆ EXAMPLE

Calculate the safety distance with the following values:

$$\begin{aligned} T_{SF4}: & \quad 14\text{ms} \\ d: & \quad 0.552 \text{ inch} \approx 14 \text{ mm} \end{aligned}$$

With these values, the calculation is as follows:

$$\begin{aligned} S & = K \times (T_s + T_c + T_{SF4B} + T_{bm}) + D_{pf} \\ & = 63 \times (T_a + 0.014) + 3.4 \times (d - 0.276)\text{inch} \\ & = 63 \times (T_a + 0.014) + 3.4 \times (0.552 - 0.276) \\ & = 63 \times T_a + 63 \times 0.014 + 3.4 \times 0.276 \\ & = 63 \times T_a + 1.8204 \\ & \approx 63 \times T_a + 1.82\text{inch} \end{aligned}$$

In case this device is installed in a system with a maximum halt time 0.1 (s)

$$\begin{aligned} S & = 63 \times T_a + 1.82 \\ & = 63 \times 0.1 + 1.82 \\ & = 8.12\text{inch} \approx 206.248\text{mm} \end{aligned}$$

Hence, as per the calculations Ds is 8.12inch  $\approx$  206.2mm.



### ◆ NOTE

Since the calculation above is performed by taking 1inch = 25.4mm, there is a slight difference between the representation in mm and that in inches. Refer to the relevant standard for details.



### 2.4.3 Influence of Reflective Surfaces



#### DANGER!

If the device is installed in a place where there are reflective surfaces, make sure to install this device so that reflected light from the reflective surfaces does not affect the receiver. Alternatively, take countermeasures such as painting, masking, roughening, or changing the material of the reflective surfaces, etc. Failure to do so may cause the sensor not to detect properly, which may result in death or serious injury.

Install this device at a distance of at least A (m, see table below) away from reflective surfaces such as metal walls, floors, ceilings, workpieces, covers, panels or glass surfaces.

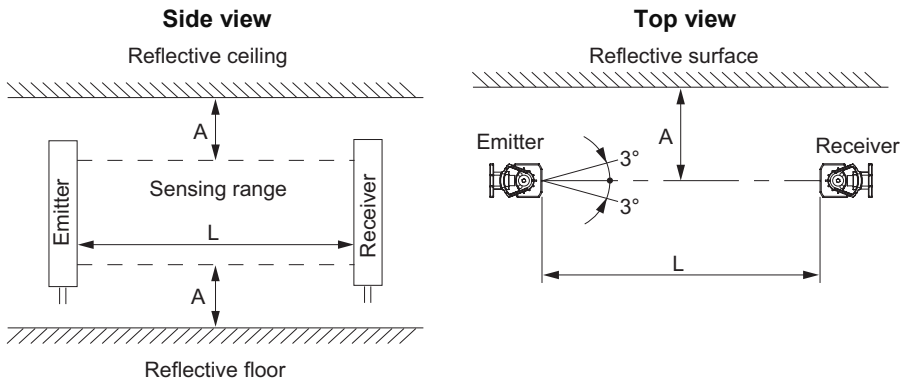

Distance between emitter and receiver (sensing range L)	Allowable installation distance A
0.3 to 3m	0.16m
3 to 7m (SF4B-F□ and SF4B-H□ (72 to 96 beam channels) and SF4B-A□ (36 to 48 beam channels))	$L \times \tan \vartheta = L \times 0.052\text{m} (\vartheta = 3^\circ)$
3 to 9 m (for SF4B-H□ (12 to 64 beam channels) and SF4B-A□ (6 to 32 beam channels))	



**◆ NOTE**

The effective aperture angle for this device is  $\pm 2.5^\circ$  (when  $L > 3\text{m}$ ) as required by IEC 61496-2 ANSI/UL 61496-2. However, install this device away from reflective surfaces considering an effective aperture angle of  $\pm 3^\circ$  to account for beam misalignment, etc. during installation.

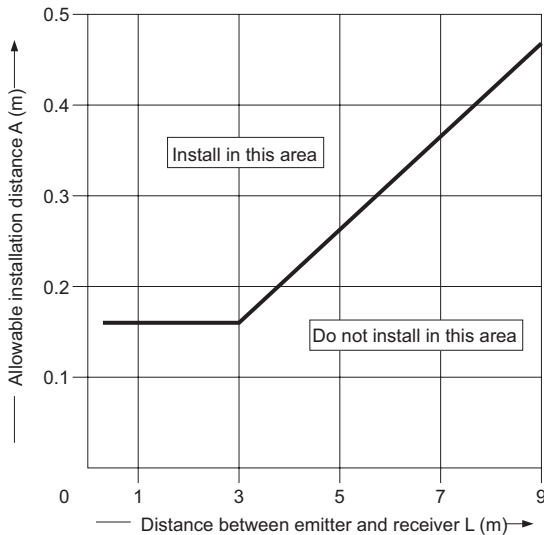

*Allowable distance from sensor beam channel to reflective surface*

**2.4.4 Placement of Emitter and Receiver**

If there is a problem with the wiring or when you need to evaluate the system before you add further equipment, place two or more sets of emitters and receivers facing each other without series or parallel connection between them. Perform an operation test (see page 71).



**DANGER!**

Refer to the examples of sensor placement as follows and understand them thoroughly before installing the sensors. Improper sensor placement could cause the sensor to malfunction, which may result in serious injury or death.

If this device is used in multiple sets, arrange them so that mutual interference is avoided. If mutual interference occurs, it can result in serious injury or death.



◆ **EXAMPLE**

1) Install the emitters or the receivers back to back

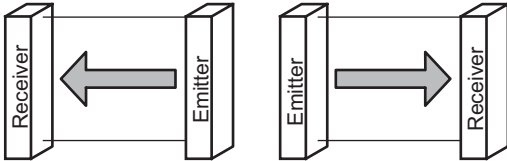

2) Arrange the emitters and the receivers vertically on opposite sides.

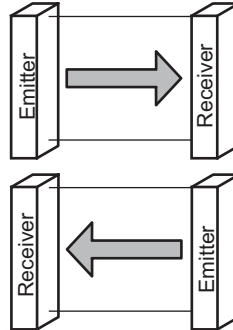

3) Arrange the emitters and the receivers horizontally on opposite sides.

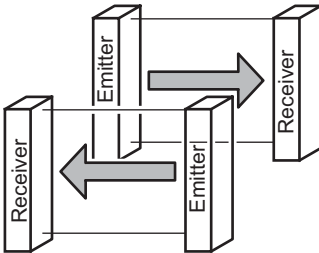

4) Install a barrier

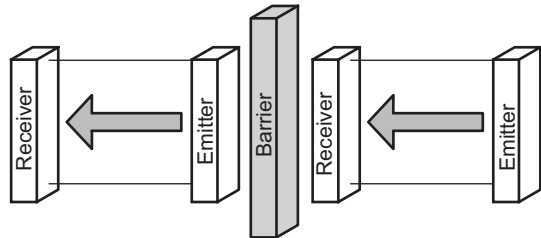

◆ **NOTE**

The figures above are just examples of sensor placement. If there are any questions or problems, please contact our office.

## 2.5 Mounting

---

There is no mounting bracket included with the device. Please purchase the mounting bracket appropriate for your installation environment. The following types of mounting brackets are available.

- Standard mounting bracket (MS-SFB-1)
- M8 360° rotatable mounting bracket (see page 131)
- M8 rear mounting bracket (MS-SFB-7-T) (see page 131)
- M8 side mounting bracket (see page 131)
- M8 rear/side mounting bracket set (MS-SFB-1-T2) (see page 132)
- Intermediate supporting bracket (MS-SFB-2)
- Dead zoneless mounting bracket (MS-SFB-3) (see page 32)
- Protect bar (MC-SFBH-□)

### 2.5.1 Mounting of the Mounting Bracket

---

Before you start mounting the device, read the following important notes carefully.



#### ◆ NOTE

---

- **Do not bend the cable of this device. Applying improper loads to the cable could cause the wire to break.**
- **The minimum bending radius of the cable is 6mm. Mount the sensor accordingly.**
- **Mount the emitter and the receiver at the same level and parallel to each other. The effective aperture angle of this device is  $\pm 2.5^\circ$  or less for a sensing distance exceeding 3m.**
- **Unless otherwise specified, the mounting procedure is common for both emitters and receivers. To prepare the mounting holes, refer to the dimension diagrams (see page 148).**
- **Models that come supplied with the intermediate supporting bracket MS-SFB-2 should only be installed with this bracket.**
- **The mounting method for the M8 360° rotatable mounting bracket (MS-SFB-1-T), the pitch adapter bracket (MS-SFB-4) and the M8 pitch adapter bracket (MS-SFB-4-T) is the same as for the standard mounting bracket (MS-SFB-1).**

- The mounting method for the M8 side mounting bracket (MS-SFB-8-T) and the rear / side mounting bracket set (MS-SFB-1-T2) is the same as for the rear mounting bracket (MS-SFB-7-T). Note that there are two different shapes for the side mounting bracket (MS-SFB-8-T) for the top and the bottom of the sensor.
- By default, the rear / side mounting bracket set (MS-SFB-1-T2) is assembled for rear mounting at the factory. The parts for side mounting are enclosed as accessories. If you want to mount the sensor on the side, remove the hexagon-socket head bolt for beam-axis alignment and mount the parts for side mounting. Note that there are two different shapes for the side mounting bracket (MS-SFB-8-T) for the top and the bottom of the sensor.

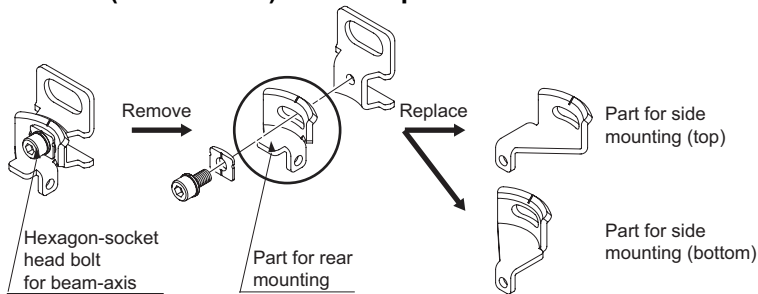

- If you mount the mounting brackets after connecting the bottom cap cable (see page 34) and the cable for series connection (see page 36), make sure to pull the cable to the other side of the hexagon-socket head bolt to prevent the cable from being squeezed by the bolt.

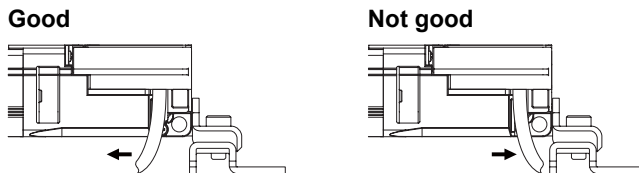

### 2.5.1.1 Standard Mounting Bracket MS-SFB-1

Unless otherwise specified, the following mounting procedure is common for both emitters and receivers. To prepare the mounting holes, refer to the dimension diagram (see page 148).



**Procedure**

- 1. Loosen the hexagon-socket head bolt (M4, length: 6mm)**

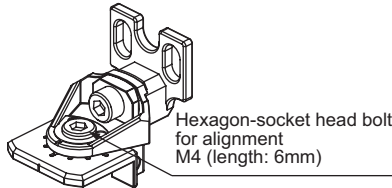

- 2. Rotate the bracket to adjust the installation direction of emitter and receiver**

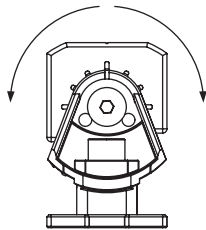

- 3. Tighten and fix the hexagon-socket head bolt for alignment**

The tightening torque should be 2N•m or less.

- 4. Set and fix both emitter and receiver so that they face each other**

Marks are engraved on the standard mounting bracket so you can adjust the direction (see page 69) of the emitter/receiver in steps of 30 degrees.

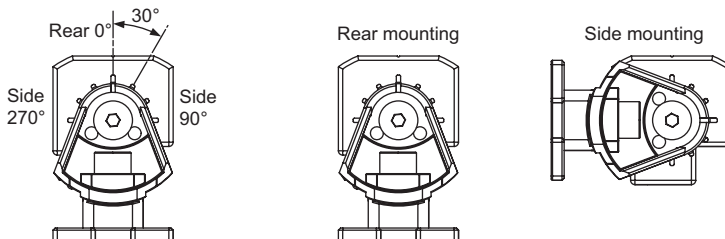

- 5. Adjust the mounting hole on the side of the safety light curtain with the mounting hole of the standard mounting bracket**

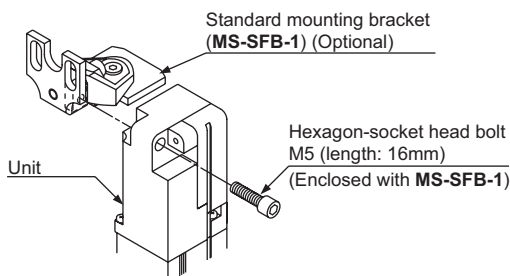

- 6. Fix the standard mounting bracket with the supplied hexagon-socket head bolt (M5, length: 16mm)**

The tightening torque should be 1.2N•m or less.

**7. Mount the standard mounting bracket (MS-SFB-1) on the mounting surface using either four M5 hexagon-socket head bolts or two M8 hexagon-socket head bolts**

The M5/M8 bolts are not supplied with the safety light curtain.

Mounting with 4 bolts

Mounting with 2 bolts

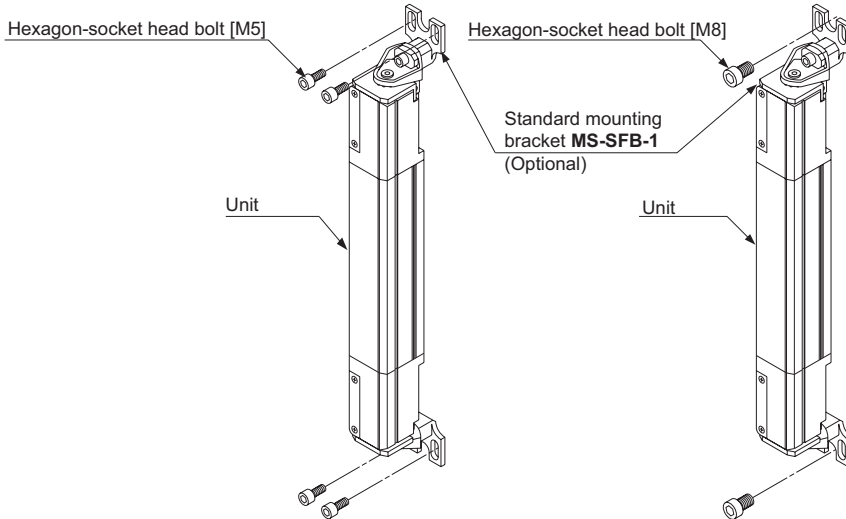

**2.5.1.2 Intermediate Supporting Bracket MS-SFB-2**

Use this bracket to fix the middle part of the main body. Rear mounting and side mounting are possible.



**Procedure**

- 1. Loosen the hexagon-socket head bolt (M4, length: 12mm) of the intermediate supporting bracket**

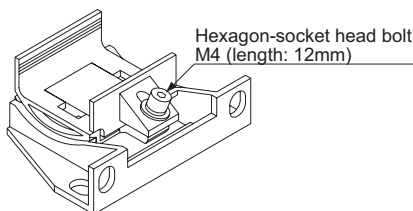

**2. Insert the side of the safety light curtain into the intermediate supporting bracket**

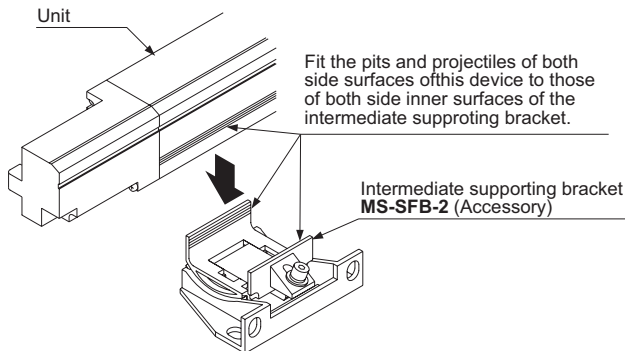

When setting the intermediate supporting bracket on both side surfaces of this device, fit the four pits and projectiles of both side surfaces of the safety light curtain to those of both side surfaces (inner surfaces) of the intermediate supporting bracket.

**3. Fix the intermediate supporting bracket with the hexagon-socket head bolt (M4, length: 12mm)**

The tightening torque should be 1.2N·m or less.

**4. Align the beam axis**

You find more information under beam-axis alignment (see page 69).

**5. Mount the intermediate supporting bracket on the mounting surface using two M5 hexagon-socket head bolts**

The M5 bolts are not supplied with intermediate supporting bracket.

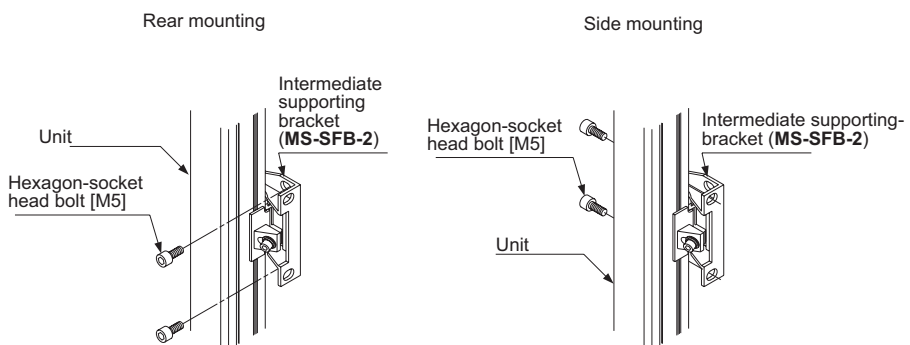



### 2.5.1.3 Dead Zoneless Mounting Bracket MS-SFB-3

Use this bracket when connecting units in series to prevent dead zones at the interfaces. Rear mounting and side mounting are possible.



#### ◆ Procedure

1. Set the spacer attached to the dead zoneless mounting bracket onto the mounting hole on the side of the top (bottom) end part of the unit
2. Insert the hexagon-socket head bolt (M4, length: 25mm) into the hole

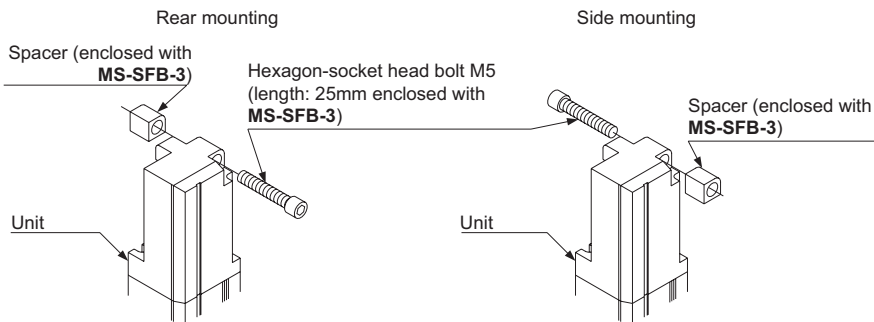

3. Adjust the hexagon-socket head bolt to the mounting hole of the dead zoneless mounting bracket (see below picture for rear or side mounting)

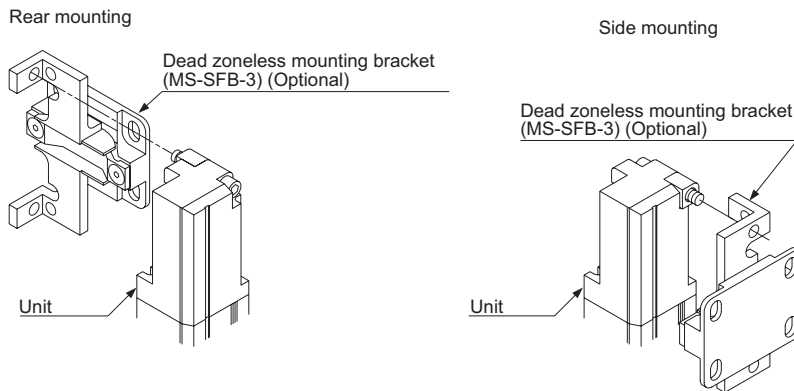

4. Tighten and fix the bracket  
The tightening torque should be 1.2N•m or less.
5. Mount the dead zoneless mounting bracket on the mounting surface using four hexagon-socket head bolts

The M5 bolts are not supplied with the dead zoneless mounting bracket.

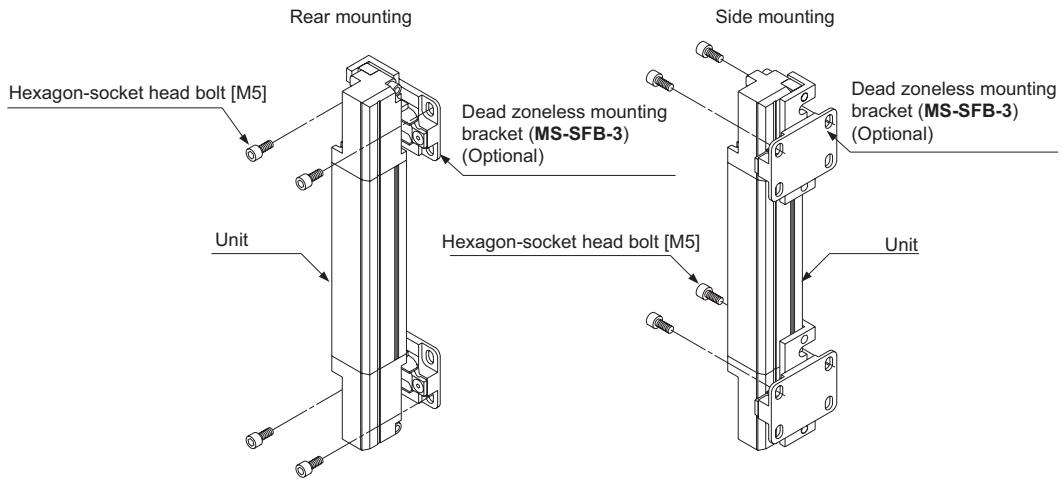

### 2.5.1.4 Protect-Bar Mounting Bracket MC-SFBH-□-T

Use this bracket if you need to protect the front face of the unit. Rear mounting and side mounting are possible.



#### ◆ NOTE

By default, the protect-bar mounting bracket (MC-SFBH-□-T) is assembled for rear mounting at the factory. The parts for side mounting are enclosed as accessories. If you want to mount the sensor on the side, remove the hexagon-socket head bolt for beam-axis alignment and mount the parts for side mounting. Note that there are two different shapes for the side mounting bracket (MS-SFB-8-T) for the top and the bottom of the sensor.

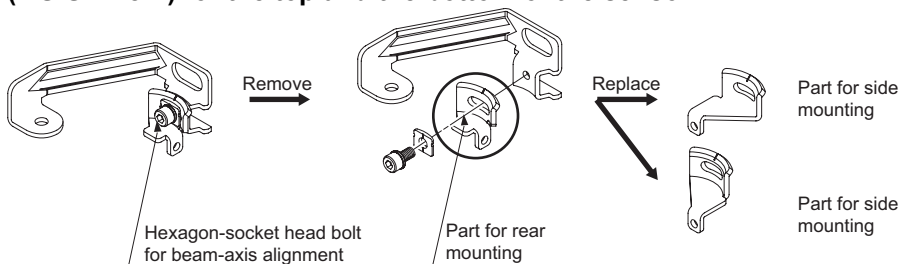

#### ◆ Procedure

1. Mount the protect bar mounting bracket to the unit with the two hexagon-socket head bolts supplied (M5, length: 18mm)  
The tightening torque should be 1.2N·m or less.
2. Mount the protect bar to the protect-bar mounting bracket with a hexagon-socket head bolt (M5, length: 20mm)

The tightening torque should be  $3\text{N}\cdot\text{m}$  or less.

3. **If the intermediate supporting bracket (MS-SFB-2) is used, mount the bracket with two hexagon-socket head bolts (M5, not supplied) on the mounting surface**
4. **If the protect-bar intermediate supporting bracket (MS-SFB-6) is used, mount the bracket with a hexagon-socket head bolt (M8, not supplied) on the mounting surface**
5. **Mount the protect-bar mounting bracket with a hexagon-socket head bolt (M8, not supplied) on the mounting surface**
6. **Adjust the angle of the emitter and the receiver horizontally within the adjustable range of the elongated hole**
7. **Tighten the M8 hexagon-socket head bolt**
8. **If used, adjust and tighten the protect-bar intermediate supporting bracket**

Marks are engraved on the protect-bar mounting bracket so you can adjust the direction (see page 69) of the emitter/receiver in steps of 30 degrees.

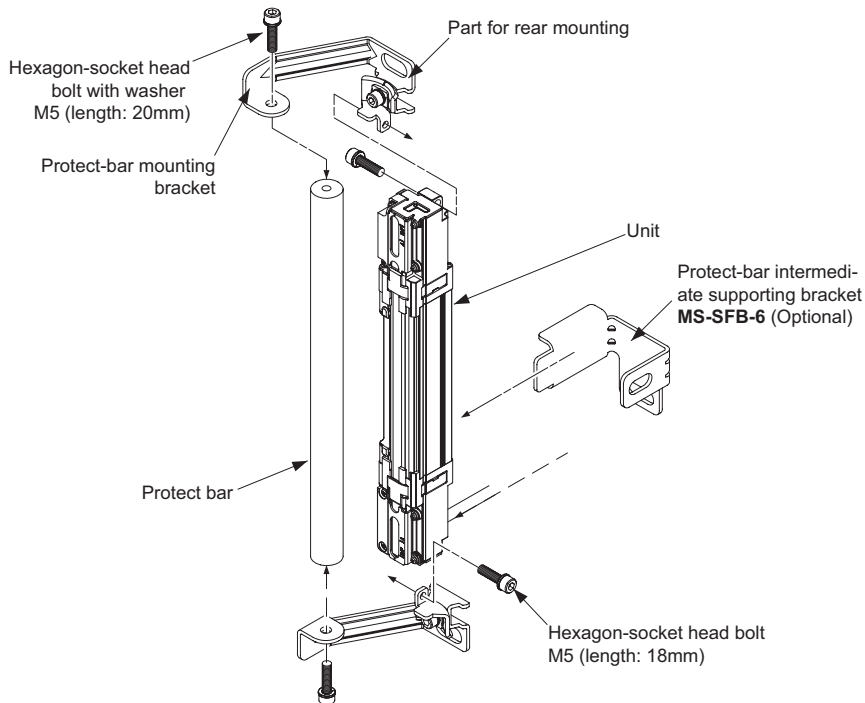

## 2.5.2 Mounting of the Bottom Cap Cable

The cable is optional and is not enclosed with the SF4B safety light curtain. There are four types bottom cap cables (see following table). The cable length is reflected in the model no.

Type		Model No.	Cable length (m)
8-core	Discrete wire type	SFB-CCB3	3
		SFB-CCB7	7
		SFB-CCB10	10
		SFB-CCB15	15
	Connector type	SFB-CB05	0.5
		SFB-CB5	5
SFB-CB10		10	
12-core	Discrete wire type	SFB-CCB3-MU	3
		SFB-CCB7-MU	7
	Connector type	SFB-CB05-MU	0.5



**◆ NOTE**

There are two cables per set: One for the emitter (gray) and one for the receiver (black).

To mount the device with the cable, please follow the next procedure.



**◆ Procedure**

- 1. Insert the connector of the bottom cap cable (optional) into the connector of the unit**

When inserting the connector, fit the cable into the groove of the unit.

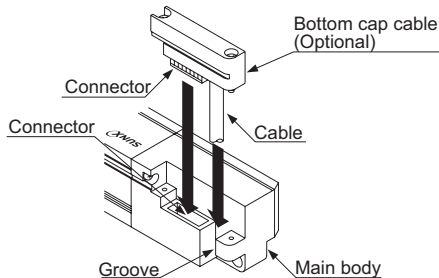

- 2. Tighten the two M2.6 screws**

The tightening torque should be 0.3 N•m or less.

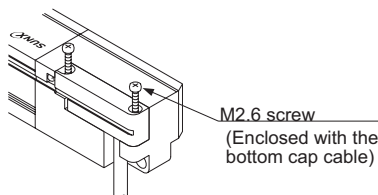

### 2.5.3 Mounting and Dismantling of a Series Connection

This section describes how to mount the cable for series connection. It is possible to connect a maximum of three sets of light curtains. Connect one or two sub systems to the main system and make sure, all emitters are on one side and all receivers are on the other side. One system consists of an emitter and a receiver. The emitter and receiver of the main system are connected by a synchronization wire.

There is no difference in the cable for series connection for the emitter and the receiver. The cable length is reflected in the model no.

Model No.	Cable length (mm)
SFB-CSL01	100
SFB-CSL05	500
SFB-CSL1	1000
SFB-CSL5	5000

Use the following procedures for mounting respectively dismantling the series connection.

#### Mounting the cable for series connection SFB-CSL

First, you need to replace the normal cable with the cable for series connection.



**NOTE**

- Do not insert the connector part aslant.

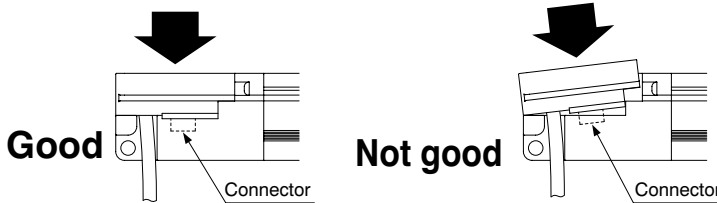

- Do not pull the cables before tightening the M2.6 screws.

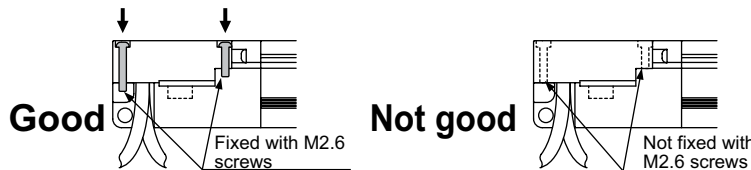

- Do not insert the connector incorrectly and tighten the M2.6 screws.

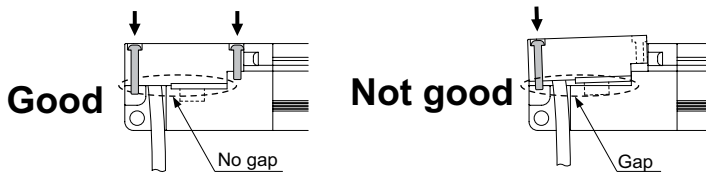

◆ Procedure

- Loosen the two M2.6 screws of the end cap of the emitter and receiver of the main system
- Remove the end cap from the unit of the main system

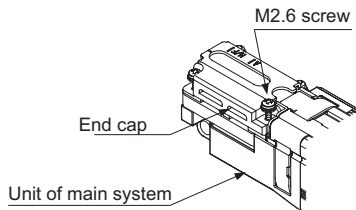

- Insert the connector of the cable for series connection (SFB-CSL) into the units of the main system and of the subsystems

When inserting the connector, fit the cable into the groove of the unit.

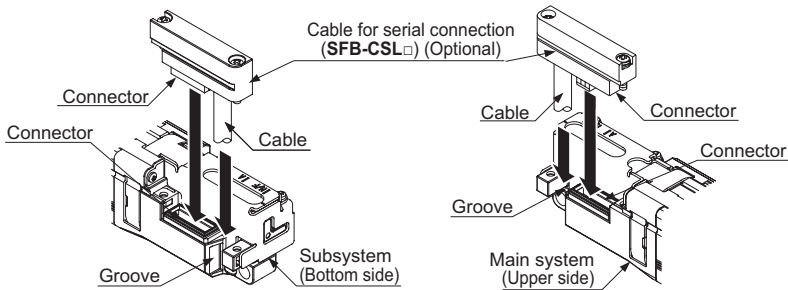

- Tighten the two M2.6 screws

The tightening torque should be 0.3N•m or less.

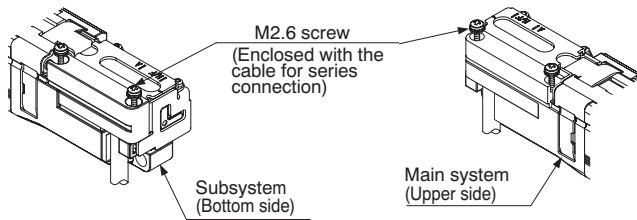

#### ◆ NOTE

- Please note that the shape of the connectors for the bottom side and for the end cap side on the cable for series connection (SFB-CSL□) is different.
- The cable for series connection (SFB-CSL□) cannot be extended.
- When the cable for series connection (SFB-CSL□) is inserted to the unit of the main system, take care not to bend the connector pins.
- To dismantle the cable for series connection, follow the preceding procedure in reverse.

## 2.6 Wiring

---



### **DANGER!**

Switch off the power before wiring the device.

All electrical wiring should conform to the regional electrical regulations and laws. The wiring should be done by engineer(s) having the required electrical knowledge.

Do not run the sensor cable together with high-voltage lines or power lines or put them together in the same raceway.

Connect the machine or the support where the sensor is mounted to the frame ground (F.G.). Failure to do so may cause the product to malfunction due to noise, resulting in serious injury or death.

The wiring should be done in a metal box connected to the frame ground (F.G.).

Take countermeasures regarding the system to ensure that dangerous performance caused by the earth failure cannot occur. Failure to do so could cause jeopardize the system stop, resulting in serious bodily injury or death.

Ground the 0V side (PNP output)/24V side (NPN output) to ensure that the output is not turned ON by accident due to an earth fault of the control output (OSSD 1, OSSD 2).

When this product is used in a situation where it has to conform to the Korean S-mark, make sure to ground the 0V side (PNP output).

Make sure to insulate the ends of the unused lead wires.

Use a safety relay unit or an equivalent safety control circuit as a final switching device (FSD).



### 2.6.1 PNP Output

#### Wiring diagram for PNP output with a 12-core cable

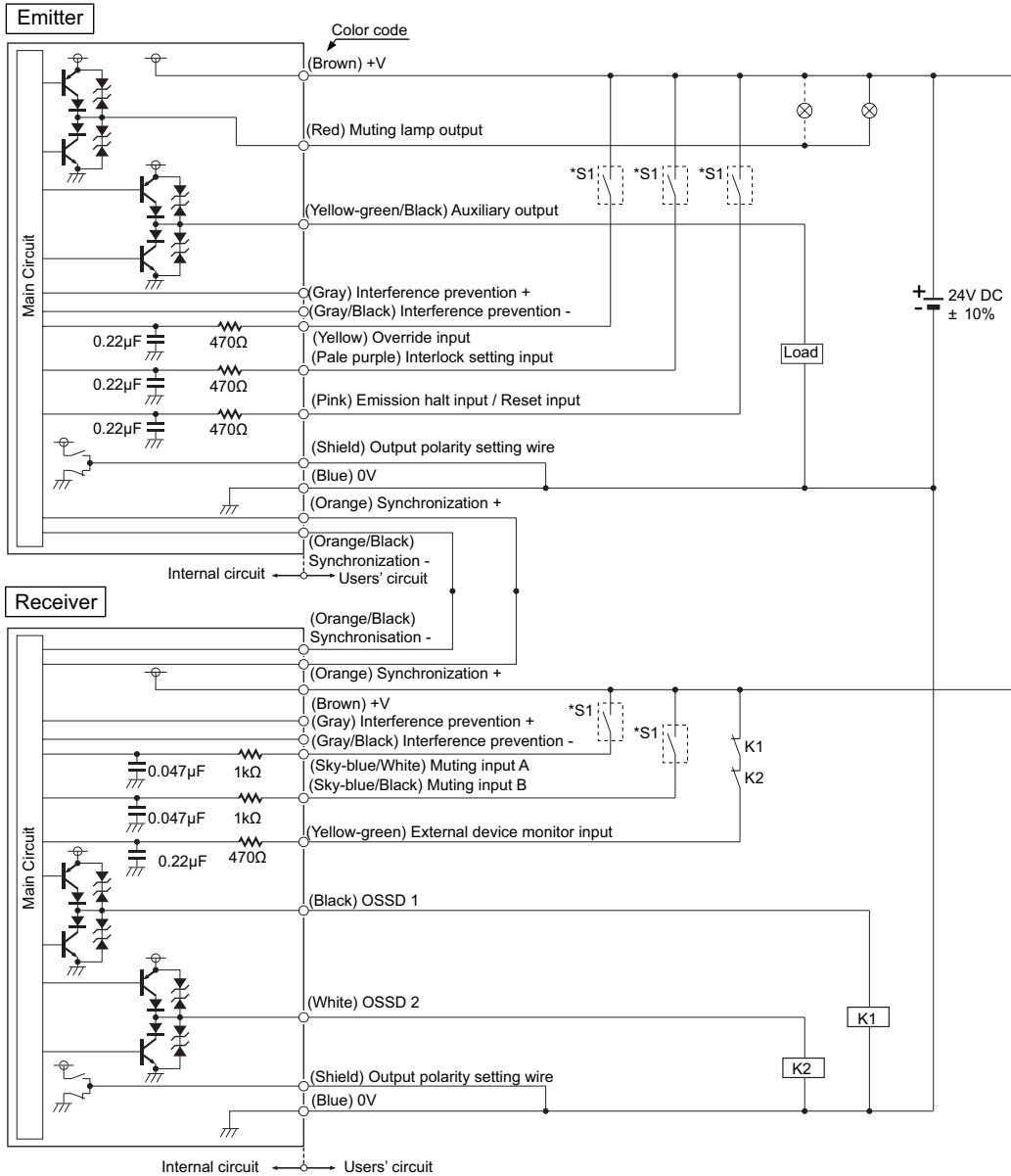

Symbols in the wiring diagram		
Switch S1	<ul style="list-style-type: none"> <li>Emission halt input/Reset input</li> </ul>	When manual reset is activated: <ul style="list-style-type: none"> <li>Vs to Vs - 2.5V (sink current: 5mA or less): Emission halt</li> <li>Open: Emission</li> </ul> When auto-reset is activated: <ul style="list-style-type: none"> <li>Vs to Vs - 2.5V (sink current: 5mA or less): Emission</li> <li>Open: Emission halt</li> </ul>

Symbols in the wiring diagram		
	<ul style="list-style-type: none"> <li>Interlock setting input, Override input, Muting input A/B, External device monitor input</li> </ul>	<ul style="list-style-type: none"> <li>Vs to Vs - 2.5 V (sink current: 5mA or less): Activates the function</li> <li>Open: Deactivates the function</li> </ul>
K1, K2	External device (forcibly guided relay or magnetic contactor)	

Vs = Applied supply voltage



#### ◆ NOTE

The circuit diagram shown above is for a 12-core cable. The 8-core cable does not use the following wires: red, yellow, gray, gray/black, sky-blue/white, sky-blue/black.

## 2.6.2 NPN Output

### Wiring diagram for NPN output with a 12-core cable

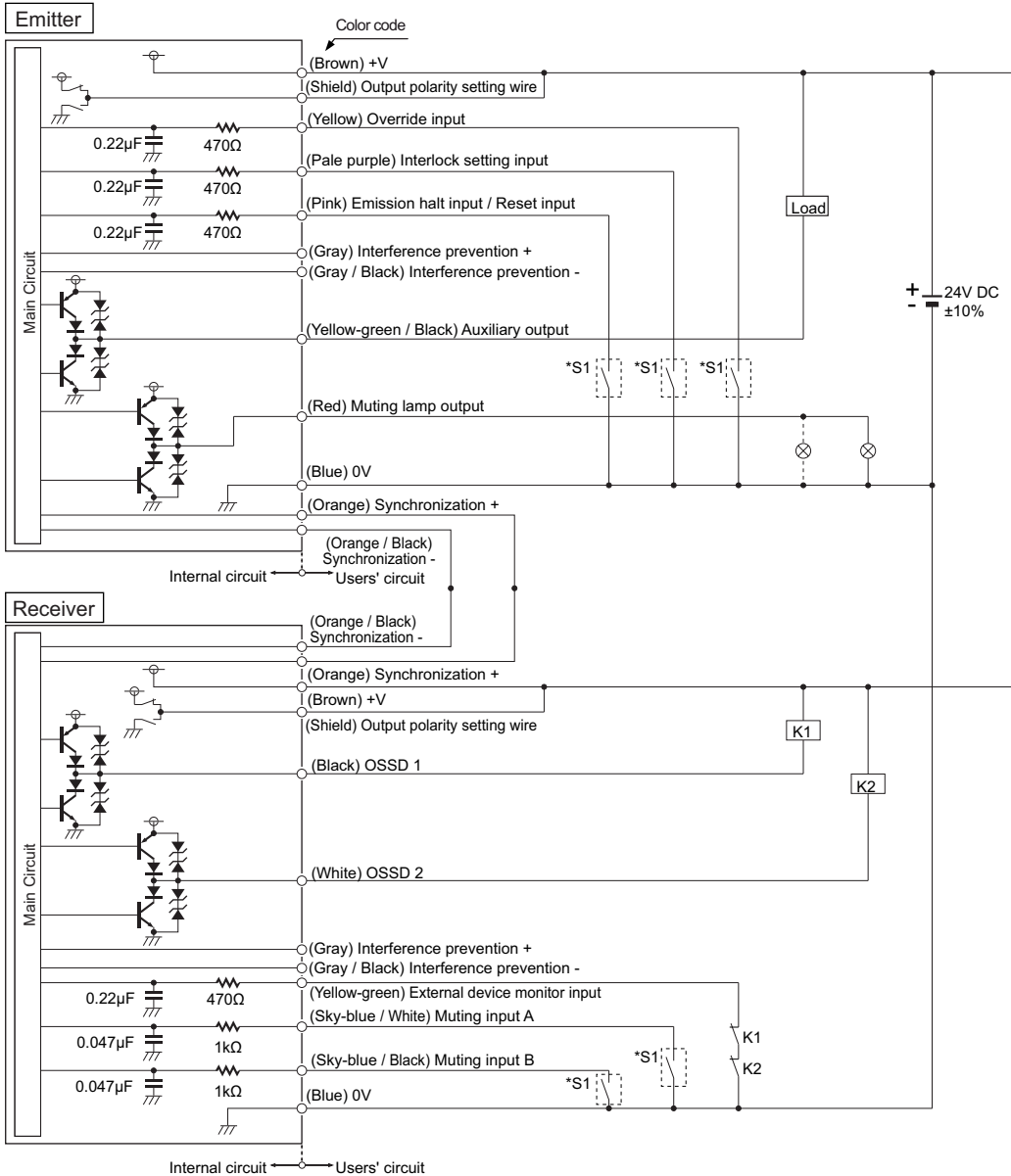

Symbols in the wiring diagram		
Switch S1	<ul style="list-style-type: none"> <li>Emission halt input/Reset input</li> </ul>	When manual reset is activated: <ul style="list-style-type: none"> <li>0 to + 1.5V (source current: 5mA or less): Emission halt</li> <li>Open: Emission</li> </ul> When auto-reset is activated: <ul style="list-style-type: none"> <li>0 to + 1.5V (source current: 5mA or less): Emission</li> </ul>

Symbols in the wiring diagram		
		<ul style="list-style-type: none"> <li>• Open: Emission halt</li> </ul>
	<ul style="list-style-type: none"> <li>• Interlock setting input, Override input, Muting input A/B, External device monitor input</li> </ul>	<ul style="list-style-type: none"> <li>• 0 to + 1.5V (source current: 5mA or less): Activates the function</li> <li>• Open: Deactivates the function</li> </ul>
K1, K2	External device (forcibly guided relay or magnetic contactor)	



**◆ NOTE**

The circuit diagram shown above is for a 12-core cable. The 8-core cable does not use the following wires: red, yellow, gray, gray/black, sky-blue/white, sky-blue/black.

**2.6.3 Power Supply Unit**

The wiring should be performed by a specialist who has the required electrical knowledge.



**DANGER!**

Wire correctly using a power supply unit which conforms to the laws and standards of the region where this device is to be used. If the power supply unit is non-conforming or the wiring is improper, it can cause damage or malfunction of this device.

The DC power supply unit must satisfy the conditions given below.

- The power supply unit must be authorized for use in the region where this device is to be used.
- The power supply unit must conform to the EMC Directive and Low-Voltage Directive.
- The power supply unit must conform to CLASS 2 (only where UL/cUL conformity is required)
- The power supply unit must have an output of 100VA or less. When this requirement is met, the power supply does not require a ground earth and satisfies the insulation distance called double-insulation or reinforced insulation as defined in IEC 60536 (CLASS: Protection against Electric Shock).
- In case the power supply conforms to the Low-Voltage Directive and has an output of 100VA or less, it can be used as a suitable product.
- The power supply unit must have an output holding time of 20ms or more.
- The frame ground (F.G.) terminal must be connected to ground when using a commercially available switching regulator.
- If there is a possibility of surge, take countermeasures such as connecting a surge absorber to the origin of the surge.

### 2.6.4 Output Signal during Self-Diagnosis

Since the receiver performs the self-diagnosis of the output circuit when the sensor is in light-receiving status (ON status), the output transistor turns OFF periodically (see following figure).

When the OFF signal is fed back, the receiver judges the output circuit as normal. When the OFF signal is not fed back, the receiver judges either the output circuit or wiring as faulty, and the control output (OSSD 1, OSSD 2) stays OFF.



#### DANGER!

Since the OFF signal of this device may cause a malfunction, pay attention to the input response time of the machine to be connected to this device when you perform the wiring.

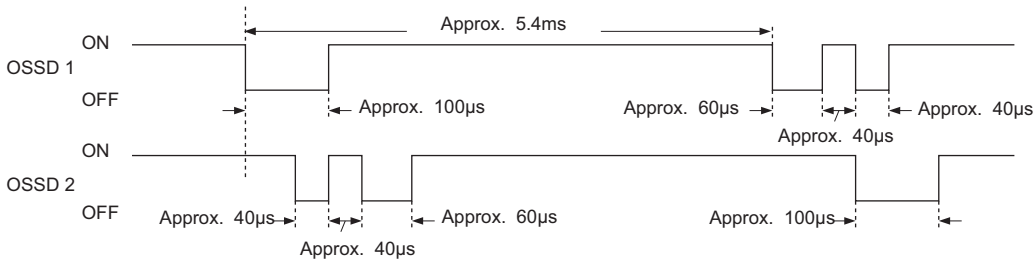

### 2.6.5 Connecting Procedure and Connector Pin Assignment

Connect the mating cable (with a connector on one end or a connector on both ends) to the connector of the safety light curtain (emitter and receiver).

Wire the other side of the mating cable according to the customer's application referring to the connector pin assignment following.



#### DANGER!

Extending the cable longer than the length specified in the following table may cause malfunction, which can result in serious injury or death.

No. of light curtain sets (emitter/receiver)	Maximum cable length
1 set	50m (40m, if a muting lamp is used)
2 sets	30m
3 sets	30m



◆ **NOTE**

- When you need to extend the synchronization wire with a cable other than the exclusive cable, use a shielded twisted-pair cable with a diameter of 0.2mm<sup>2</sup> or more.
- When this device is used in conformity with the Korean S-mark, the power wire to be connected to this device should be less than 10m long.

Bottom cap cable/discrete wire



Bottom cap cable/connector

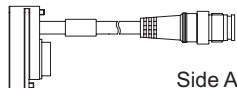

Extension cable with connector on one end

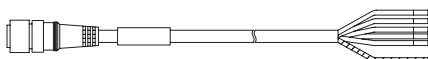

Extension cable with connectors on both ends

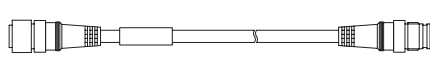

Side B

Side B

Side A

Connector at A side (for emitter/receiver)

Connector at B side (for emitter/receiver)

8-core

12-core

8-core

12-core

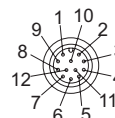
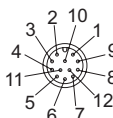
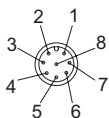

A and B side connectors (8-core and 12-core cable)

**8-core cable SFB-CC**

	Cable/connector color	Pin No.	Lead wire color	Description
<b>Emitter</b>	Gray/Gray	1	Pale purple	Interlock setting input
		2	Brown	24V DC
		3	Pink	Emission halt input/Reset input
		4	Yellow-green/Black	Auxiliary output
		5	Orange	Synchronization +
		6	Orange/Black	Synchronization -
		7	Blue	0V
		8	(Shield)	Output polarity setting wire
<b>Receiver</b>	Gray (with black stripe)/Black	1	White	Control output 2 (OSSD 2)
		2	Brown	24V DC
		3	Black	Control output 1 (OSSD 1)
		4	Yellow-green	External device monitor input
		5	Orange	Synchronization +
		6	Orange/Black	Synchronization -
		7	Blue	0V
		8	(Shield)	Output polarity setting wire

**12-core cable SFB-CC□-MU**

	Cable/connect or color	Pin No.	Lead wire color	Description
<b>Emitter</b>	Gray/Gray	1	Pale purple	Interlock setting input
		2	Brown	24V DC
		3	Pink	Emission halt input/Reset input
		4	Yellow-green/Black	Auxiliary output
		5	Orange	Synchronization +
		6	Orange/Black	Synchronization -
		7	Blue	0V
		8	(Shield)	Output polarity setting wire
		9	Gray	Interference prevention +
		10	Gray/Black	Interference prevention -
		11	Yellow	Override input
		12	Red	Muting lamp output
<b>Receiver</b>	Gray (with black stripe)/Black	1	White	Control output 2 (OSSD 2)
		2	Brown	24V DC
		3	Black	Control output 1 (OSSD 1)
		4	Yellow-green	External device monitor input
		5	Orange	Synchronization +
		6	Orange/Black	Synchronization -
		7	Blue	0V
		8	(Shield)	Output polarity setting wire
		9	Gray	Interference prevention +
		10	Gray/Black	Interference prevention -
		11	Sky-blue/White	Muting input A
		12	Sky-blue/Black	Muting input B



**◆ NOTE**

The connectors can be distinguished by their color as follows:

- Connector for emitter: gray
- Connector for receiver: black

**2.6.6 Basic Wiring**

This is the general configuration using one set of an emitter and a receiver facing each other. The control output (OSSD 1, OSSD 2) turns OFF if the light is blocked, while it automatically turns ON if the light goes through.

The auxiliary output (Yellow-green/Black) has to be connected with the external device monitor function (Yellow-green).

Feature	Setting
Interlock function (see page 75)	Deactivated (Auto-reset)
External device monitor function (see page 79)	Deactivated
Auxiliary output (see page 78)	Not available

**Basic wiring for PNP output with a 12-core cable**

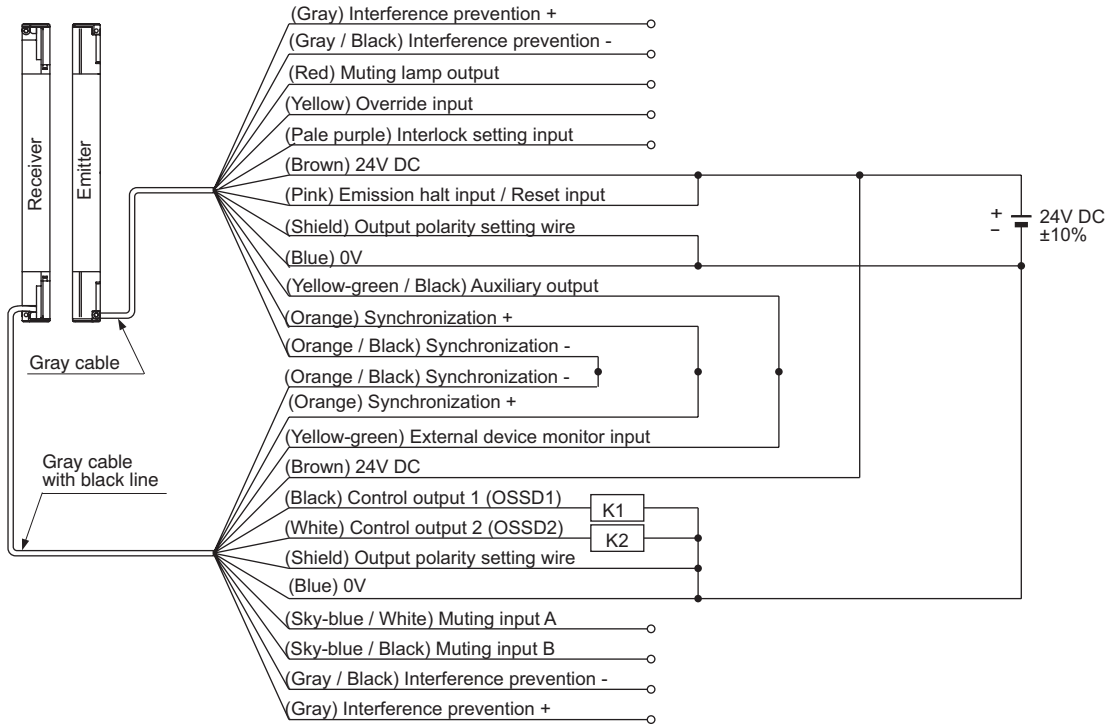



**Basic wiring for NPN output with a 12-core cable**

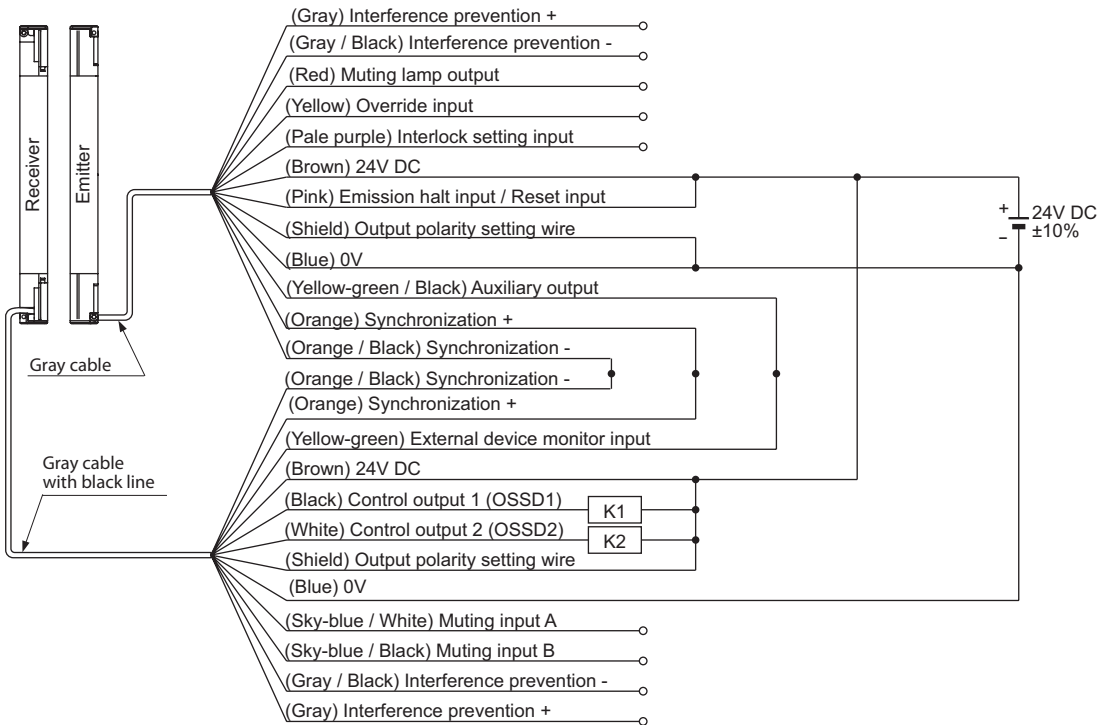

**◆ NOTE**

The circuit diagrams shown above are for a 12-core cable. The 8-core cable does not use the following wires: red, yellow, gray, gray/black, sky-blue/white, sky-blue/black.

**2.6.7 Wiring Examples**

The following examples show how this device should be wired depending on the connection method and which function is used.

**2.6.7.1 Manual Reset When Interlock is Activated (Control Category 4)**

This is the general configuration using one set of an emitter and a receiver facing each other. The control output (OSSD 1, OSSD 2) turns OFF if the light is blocked.

Feature	Setting
Interlock function (see page 75)	Activated (manual reset)
External device monitor function (see page 79)	Activated
Auxiliary output (see page 78)	Available

**PNP output wiring for a 12-core cable**

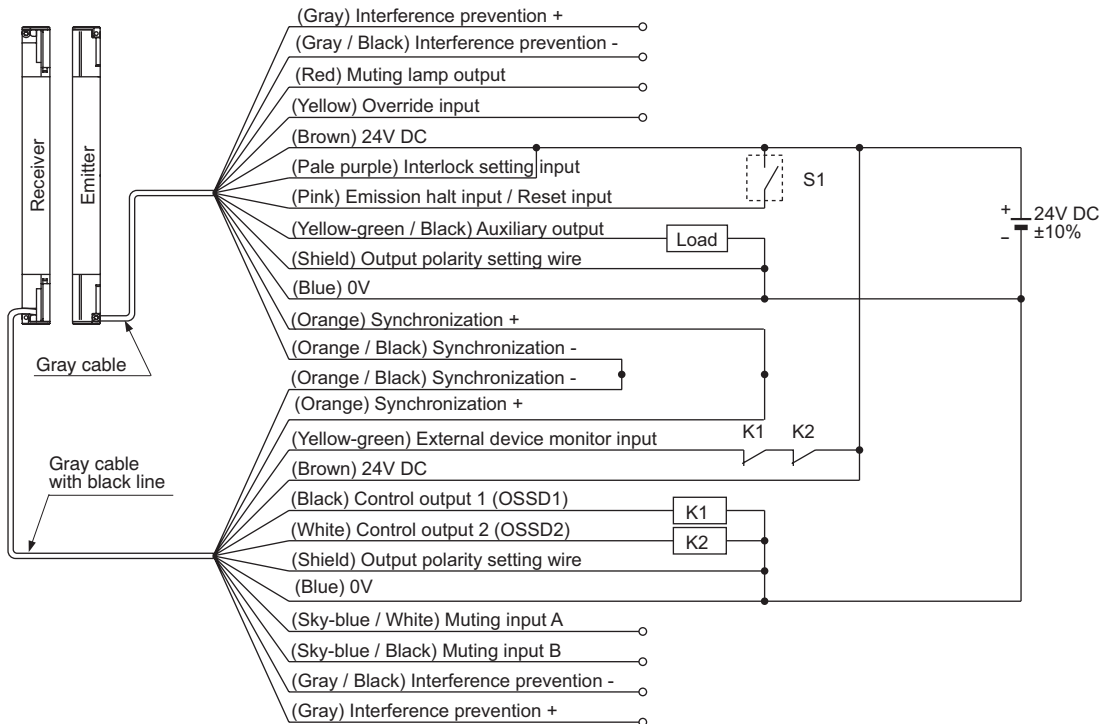

Symbols in the wiring diagram	
Switch S1	<ul style="list-style-type: none"> <li>• <math>V_s</math> to <math>V_s - 2.5V</math> (sink current: 5mA or less): Emission halt</li> <li>• Open: Emission</li> </ul>
K1, K2	External device (forcibly guided relay or magnetic contactor)

$V_s$  = Applied supply voltage

**NPN output wiring for a 12-core cable**

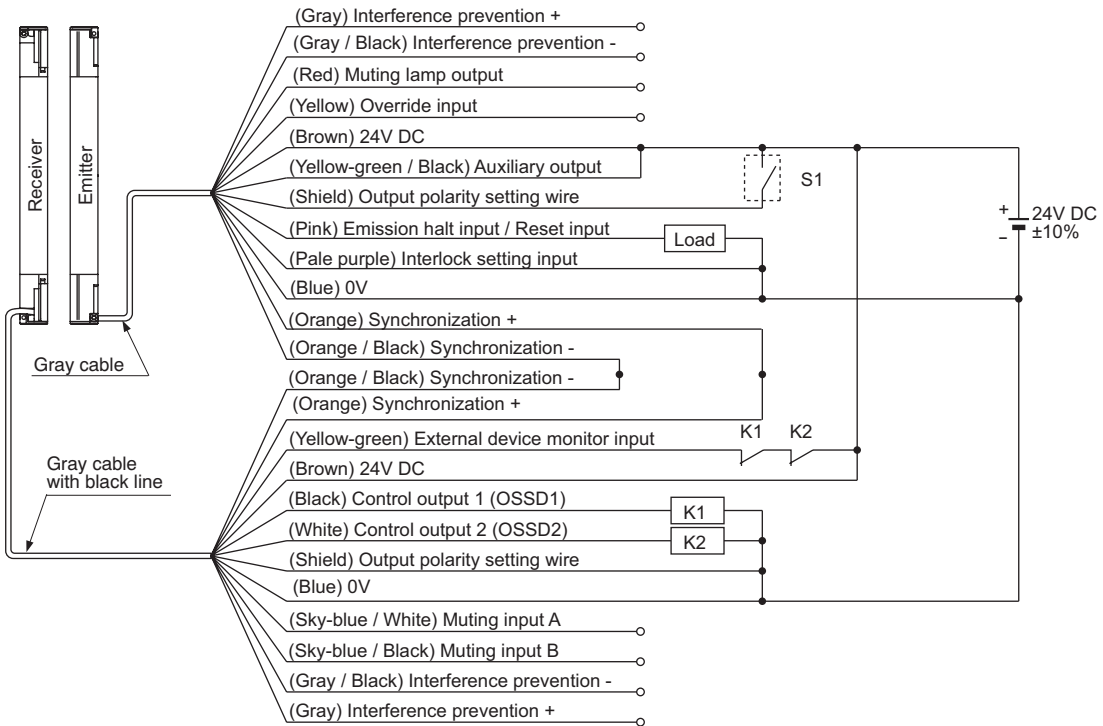

Symbols in the wiring diagram	
Switch S1	<ul style="list-style-type: none"> <li>● 0 to +1.5V (source current 5mA or less): Emission halt</li> <li>○ Open: Emission</li> </ul>
K1, K2	External device (forcibly guided relay or magnetic contactor)



**◆ NOTE**

- The OSSD output type (PNP or NPN) is determined by the connecting state of the shield wire. Incorrect wiring may cause a lockout.
- The circuit diagrams shown above are for a 12-core cable. The 8-core cable uses the following wires: red, yellow, gray, gray/black, sky-blue/white, sky-blue/black. There is no lead wire.

**2.6.7.2 Series Connection (Control Category 4)**

This is the configuration for connecting up to 3 sets of emitters and receivers in series with a maximum of 192 beam channels facing each other. It is used when the dangerous part can be accessed from two or more directions. The control output (OSSD 1, OSSD 2) turns OFF if the light is blocked.

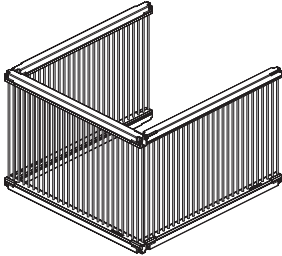

*Series connection*



**DANGER!**

**Use only the cable SFB-CSL to connect emitters and receivers in series. Connecting the emitters and receivers incorrectly may result in a dead non-sensing area, which could lead to serious injury or death.**

Feature	Setting
Interlock function (see page 75)	Activated (manual reset)
External device monitor function (see page 79)	Activated
Auxiliary output (see page 78)	Available

**Wiring for series connection of a 12-core cable with PNP output**

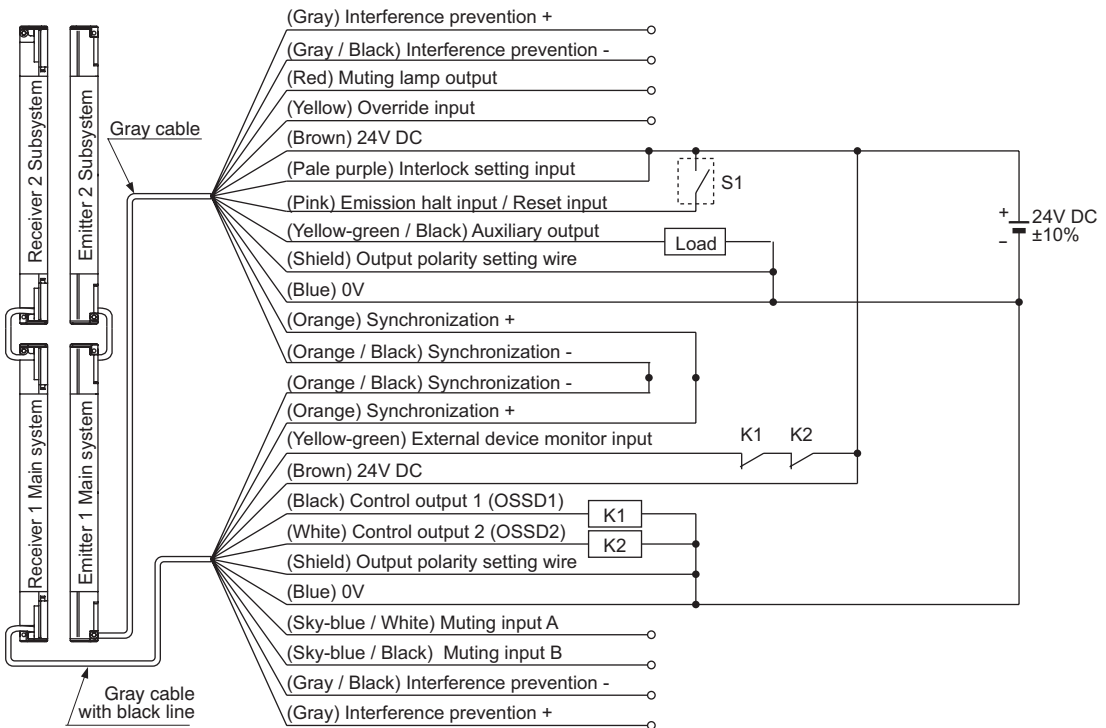

Symbols in the wiring diagram	
Switch S1	<ul style="list-style-type: none"> <li>• Vs to Vs - 2.5V (sink current: 5mA or less): Emission halt</li> <li>• Open: Emission</li> </ul>
K1, K2	External device (forcibly guided relay or magnetic contactor)

Vs = Applied supply voltage



◆ NOTE

The circuit diagrams shown above are for a 12-core cable. The 8-core cable uses the following wires: red, yellow, gray, gray/black, sky-blue/white, sky-blue/black. There is no lead wire.

Wiring for series connection of a 12-core cable with NPN output

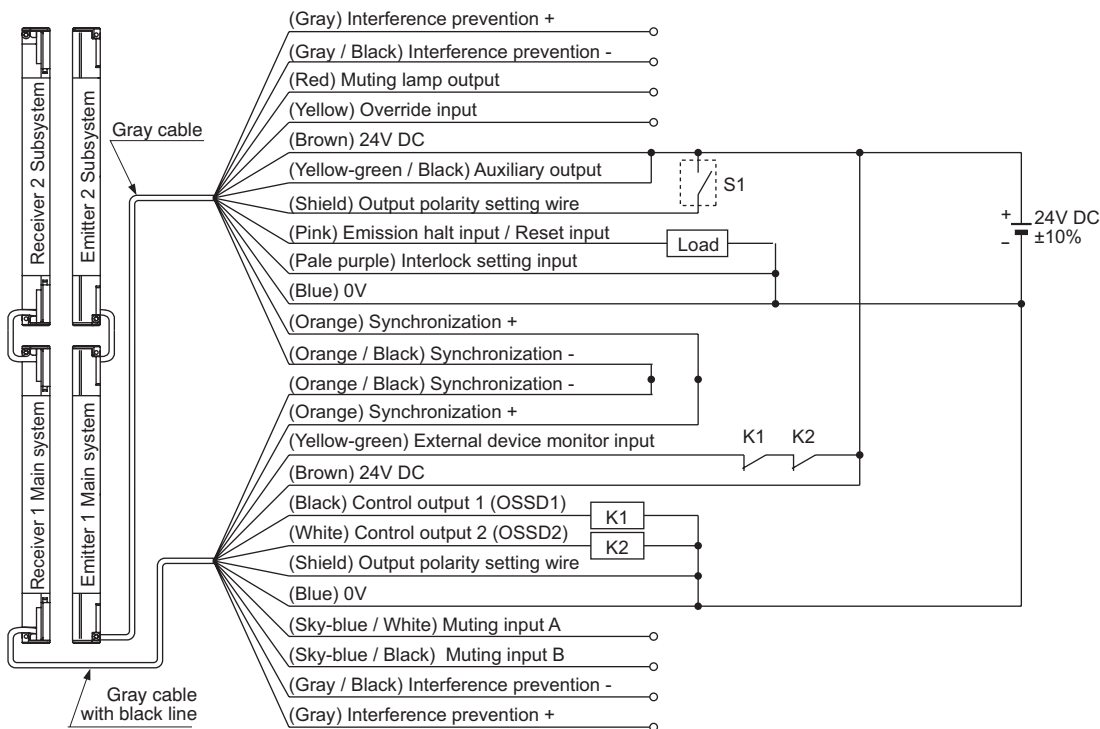

Symbols in the wiring diagram	
Switch S1	<ul style="list-style-type: none"> <li>• 0 to +1.5V (source current 5mA or less): Emission halt</li> <li>• Open: Emission</li> </ul>
K1, K2	External device (forcibly guided relay or magnetic contactor)



◆ NOTE

- The OSSD output type (PNP or NPN) is determined by the connecting state of the shield wire. Incorrect wiring may cause a lockout.
- The circuit diagrams shown above are for a 12-core cable. The 8-core cable uses the following wires: red, yellow, gray, gray/black, sky-blue/white, sky-blue/black. There is no lead wire.

### 2.6.7.3 Parallel Connection (Control Category 4)

This is the configuration for connecting multiple sets of emitters and receivers facing each other in parallel. It is used when there are two dangerous parts and each dangerous part can be accessed from only one direction. By connecting the interference prevention wire, up to three sets of the light curtain can be connected. For the control output (OSSD 1, OSSD 2), only the output of the sensor of which the light is blocked turns OFF.



**DANGER!**

**For parallel connection, connect the one receiver to the other connection using the interference prevention line as shown in the following figure. Connecting the emitters and receivers incorrectly may result in a dead non-sensing area, resulting in serious injury or death.**

Feature	Setting
Interlock function (see page 75)	Activated (manual reset)
External device monitor function (see page 79)	Activated
Auxiliary output (see page 78)	Available

**Parallel connection with PNP output**

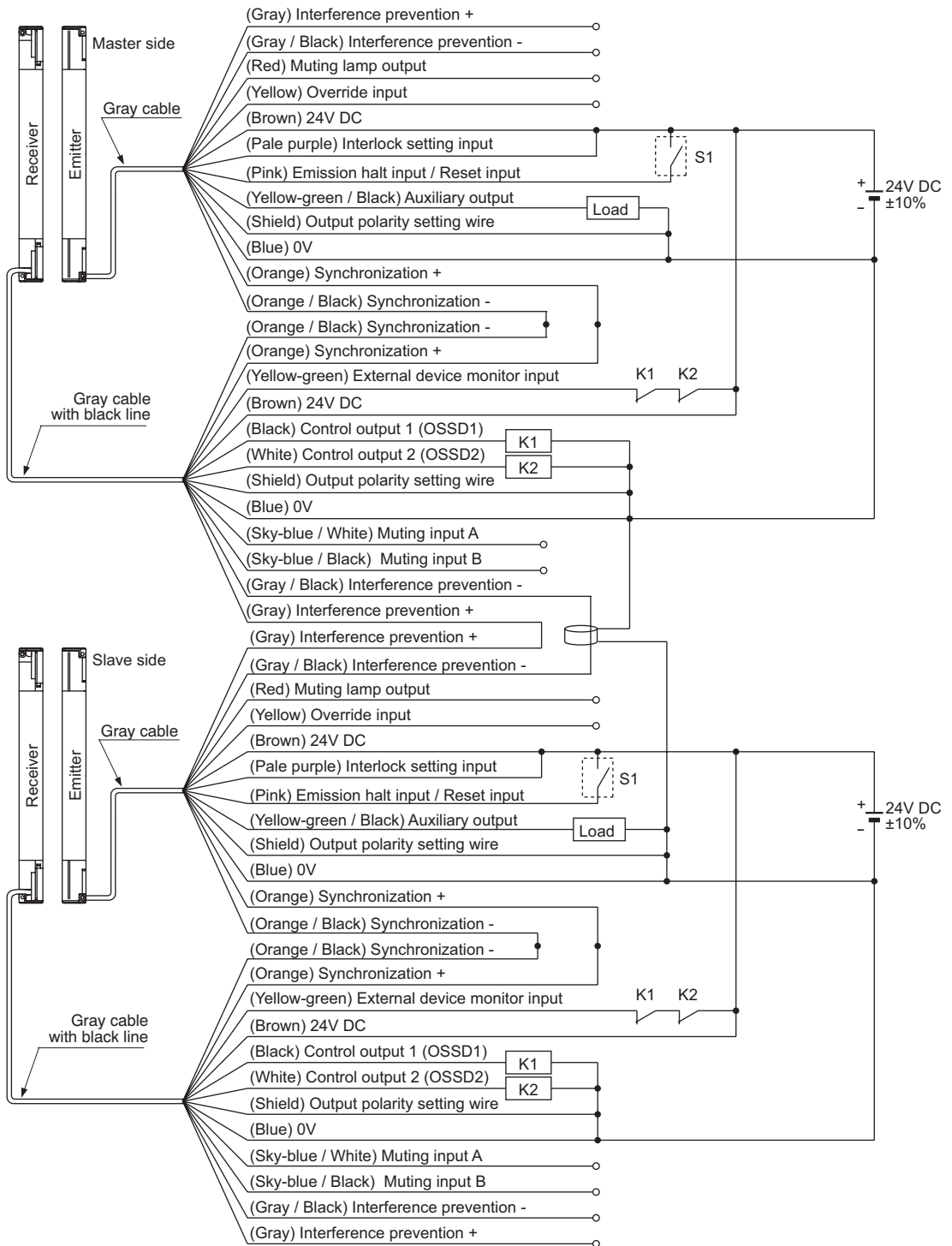



Symbols in the wiring diagram	
Switch S1	<ul style="list-style-type: none"><li>• <math>V_s</math> to <math>V_s - 2.5V</math> (sink current: 5mA or less): Emission halt</li><li>• Open: Emission</li></ul>
K1, K2	External device (forcibly guided relay or magnetic contactor)

$V_s$  = Applied supply voltage



#### ◆ NOTE

- The OSSD output type (PNP or NPN) is determined by the connecting state of the shield wire. Incorrect wiring may cause a lockout.
- If you extend the interference prevention wire, use a shielded twisted-pair cable with a diameter of 0.2mm<sup>2</sup> or more.

**Parallel connection with NPN output**

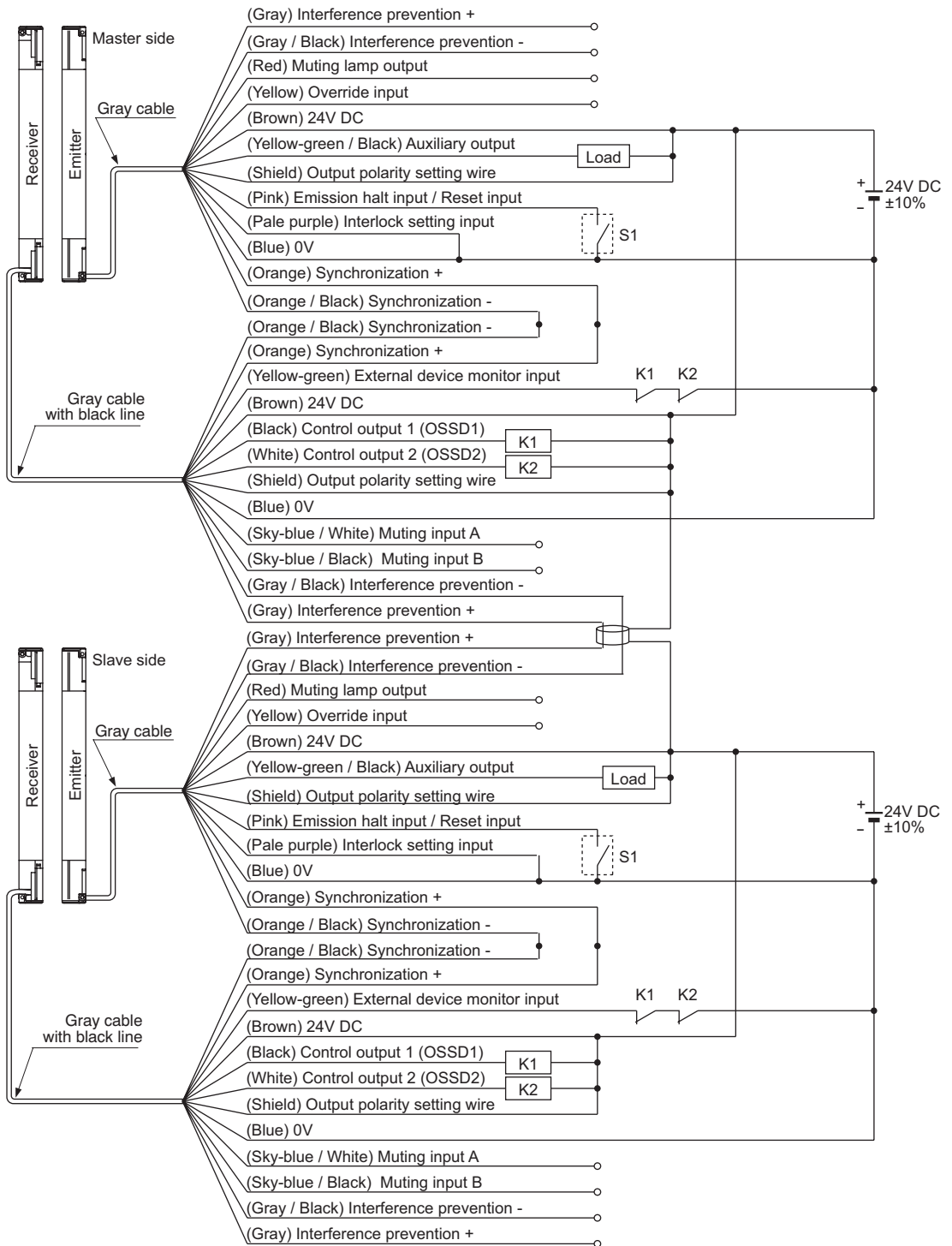

Symbols in the wiring diagram	
Switch S1	<ul style="list-style-type: none"> <li>• 0 to +1.5V (source current 5mA or less): Emission halt</li> <li>• Open: Emission</li> </ul>
K1, K2	External device (forcibly guided relay or magnetic contactor)



**◆ NOTE**

- **The OSSD output type (PNP or NPN) is determined by the connecting state of the shield wire. Incorrect wiring may cause a lockout.**
- **If you extend the interference prevention wire, use a shielded twisted-pair cable with a diameter of 0.2mm<sup>2</sup> or more.**

**2.6.7.4 Mixed Connection (Control Category 4)**

This is the configuration for connecting multiple sets of emitters and receivers facing each other in a combination of series and parallel connections. It is used when there are two or more dangerous parts that can be accessed from two or more directions. You can connect up to three sets of sensors in total in the series and parallel mixed connection. The total number of beam channels available is 192. The control outputs (OSSD 1, OSSD 2) only turn OFF if the light is blocked.



**DANGER!**

**Use only the cable SFB-CSL to connect emitters and receivers in series. Connecting the emitters and receivers incorrectly may result in a dead non-sensing area, which could lead to serious injury or death.**

**For parallel connection, connect the one receiver to the other connection using the interference prevention line as shown in the following figure. Connecting the emitters and receivers incorrectly may result in a dead non-sensing area, resulting in serious injury or death.**

Feature	Setting
Interlock function (see page 75)	Activated (manual reset)
External device monitor function (see page 79)	Activated
Auxiliary output (see page 78)	Available

**Mixed series and parallel connection with PNP output**

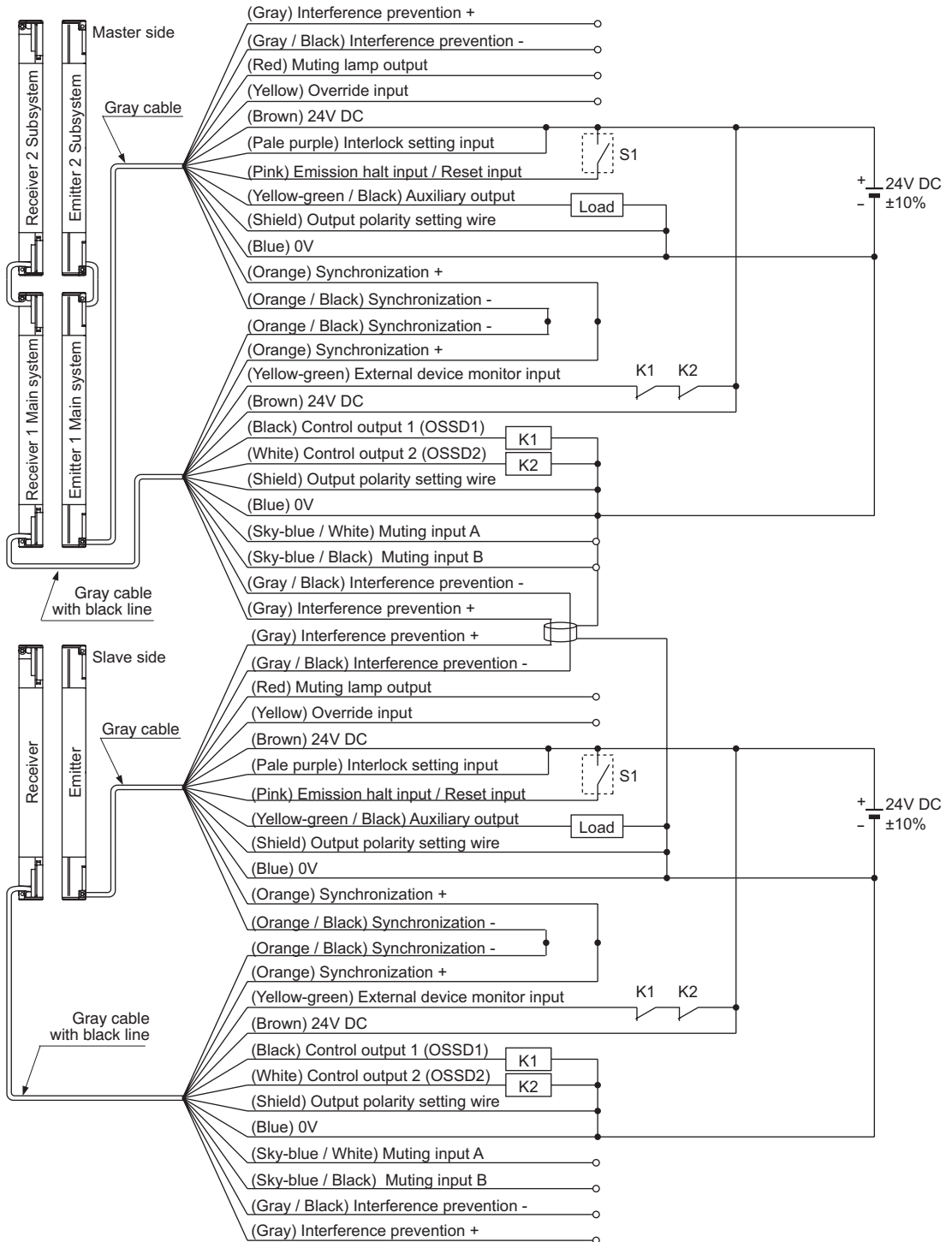

Symbols in the wiring diagram	
Switch S1	<ul style="list-style-type: none"><li>• <math>V_s</math> to <math>V_s - 2.5V</math> (sink current: 5mA or less): Emission halt</li><li>• Open: Emission</li></ul>
K1, K2	External device (forcibly guided relay or magnetic contactor)

$V_s$  = Applied supply voltage



#### ◆ NOTE

- **The OSSD output type (PNP or NPN) is determined by the connecting state of the shield wire. Incorrect wiring may cause a lockout.**
- **If you extend the interference prevention wire, use a shielded twisted-pair cable with a diameter of 0.2mm<sup>2</sup> or more.**

**Mixed series and parallel connection with NPN output**

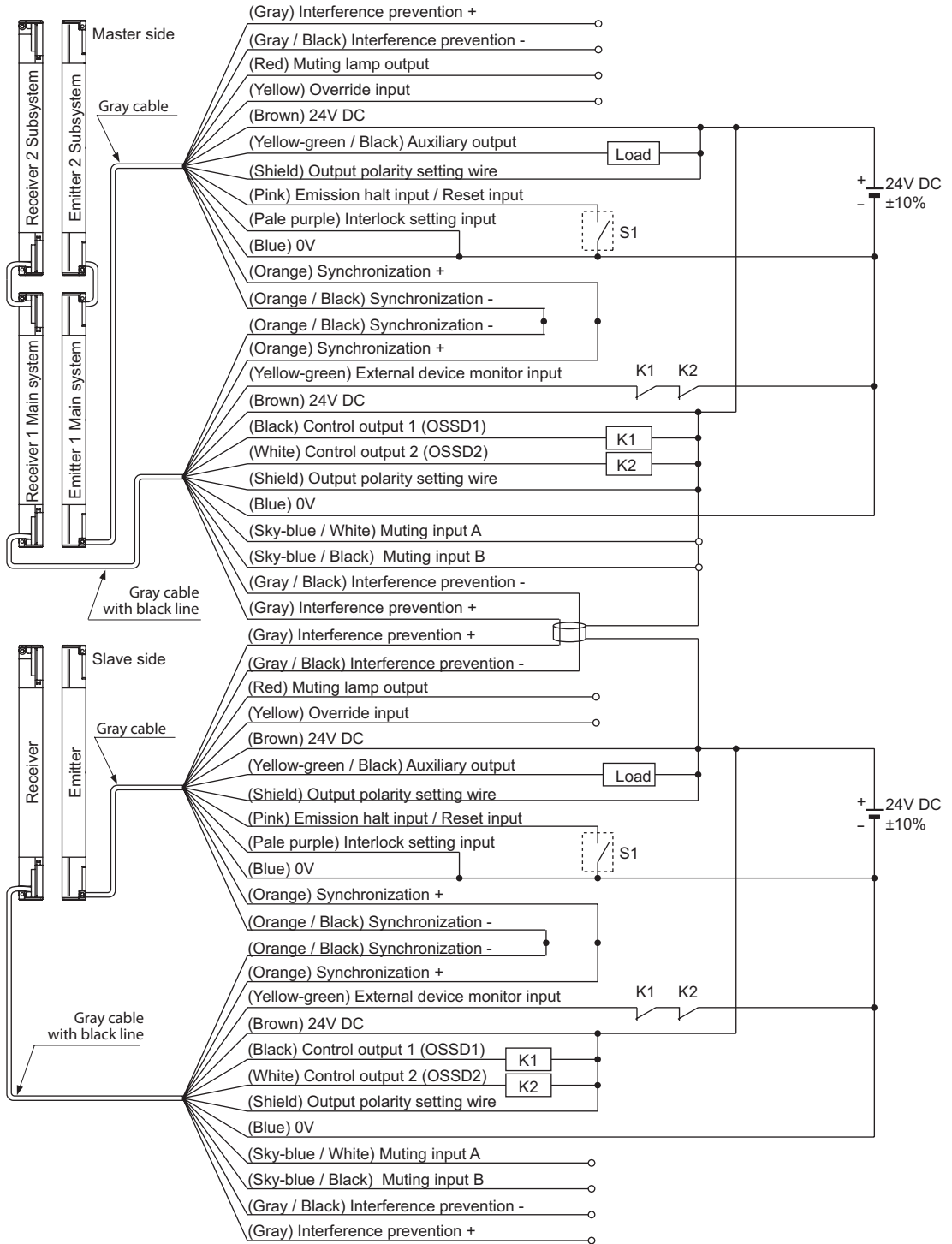

Symbols in the wiring diagram	
Switch S1	<ul style="list-style-type: none"> <li>0 to +1.5V (source current 5mA or less): Emission halt</li> <li>Open: Emission</li> </ul>
K1, K2	External device (forcibly guided relay or magnetic contactor)



◆ **NOTE**

- The OSSD output type (PNP or NPN) is determined by the connecting state of the shield wire. Incorrect wiring may cause a lockout.
- If you extend the interference prevention wire, use a shielded twisted-pair cable with a diameter of 0.2mm<sup>2</sup> or more.

**2.6.7.5 Auto-Reset (Control Category 4)**

Feature	Setting
Interlock function (see page 75)	Deactivated (auto-reset)
External device monitor function (see page 79)	Activated
Auxiliary output (see page 78)	Available

**Wiring for PNP output when the auto-reset function is active**

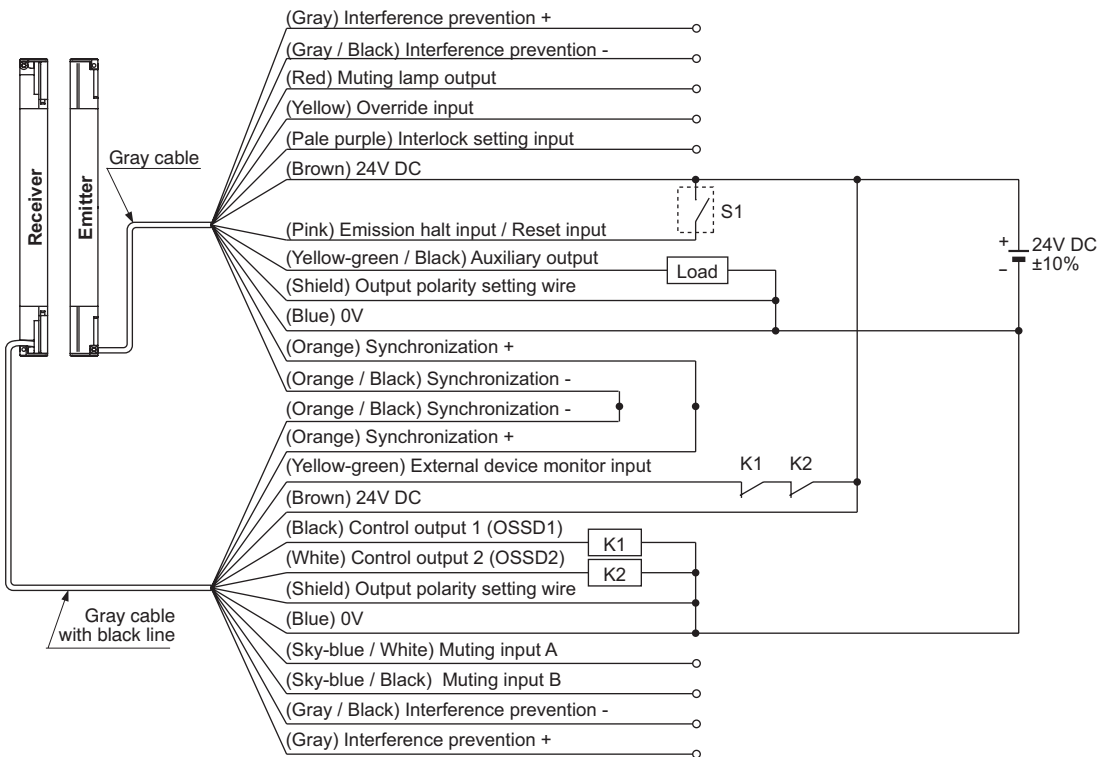

**Symbols in the wiring diagram**

Switch S1	<ul style="list-style-type: none"> <li>• Vs to Vs - 2.5V (sink current: 5mA or less): Emission halt</li> <li>• Open: Emission</li> </ul>
K1, K2	External device (forcibly guided relay or magnetic contactor)

Vs = Applied supply voltage



**NOTE**

- The OSSD output type (PNP or NPN) is determined by the connecting state of the shield wire. Incorrect wiring may cause a lockout.
- The circuit diagrams shown above are for a 12-core cable. The 8-core cable uses the following wires: red, yellow, gray, gray/black, sky-blue/white, sky-blue/black. There is no lead wire.

**Wiring for NPN output when the auto-reset function is active**

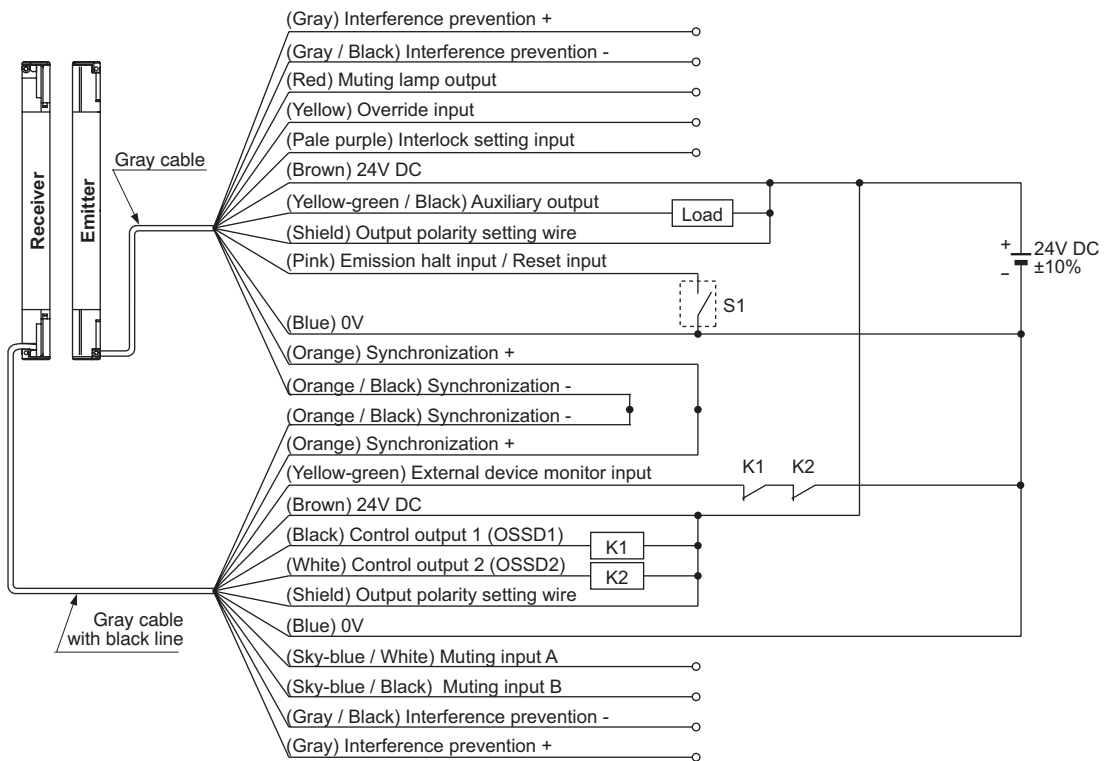

**Symbols in the wiring diagram**

Switch S1	<ul style="list-style-type: none"> <li>• 0 to +1.5V (source current 5mA or less): Emission halt</li> <li>• Open: Emission</li> </ul>
K1, K2	External device (forcibly guided relay or magnetic contactor)





◆ **NOTE**

- The OSSD output type (PNP or NPN) is determined by the connecting state of the shield wire. Incorrect wiring may cause a lockout.
- The circuit diagrams shown above are for a 12-core cable. The 8-core cable uses the following wires: red, yellow, gray, gray/black, sky-blue/white, sky-blue/black. There is no lead wire.

**2.6.7.6 External Device Monitor Function Deactivated (Control Category 4)**

This is the configuration for connecting an auxiliary output and external device monitor input. Deactivate the external device monitor function with the handy controller. Set the auxiliary output with 'negative logic of the control outputs (OSSD 1, OSSD 2)' (factory setting) with the handy controller SFB-HC (optional). The auxiliary output cannot be connected to external devices.

Feature	Setting
Interlock function (see page 75)	Deactivated (auto-reset)
External device monitor function (see page 79)	Deactivated
Auxiliary output (see page 78)	Not available

**Wiring for PNP output when the external device monitor function is deactivated**

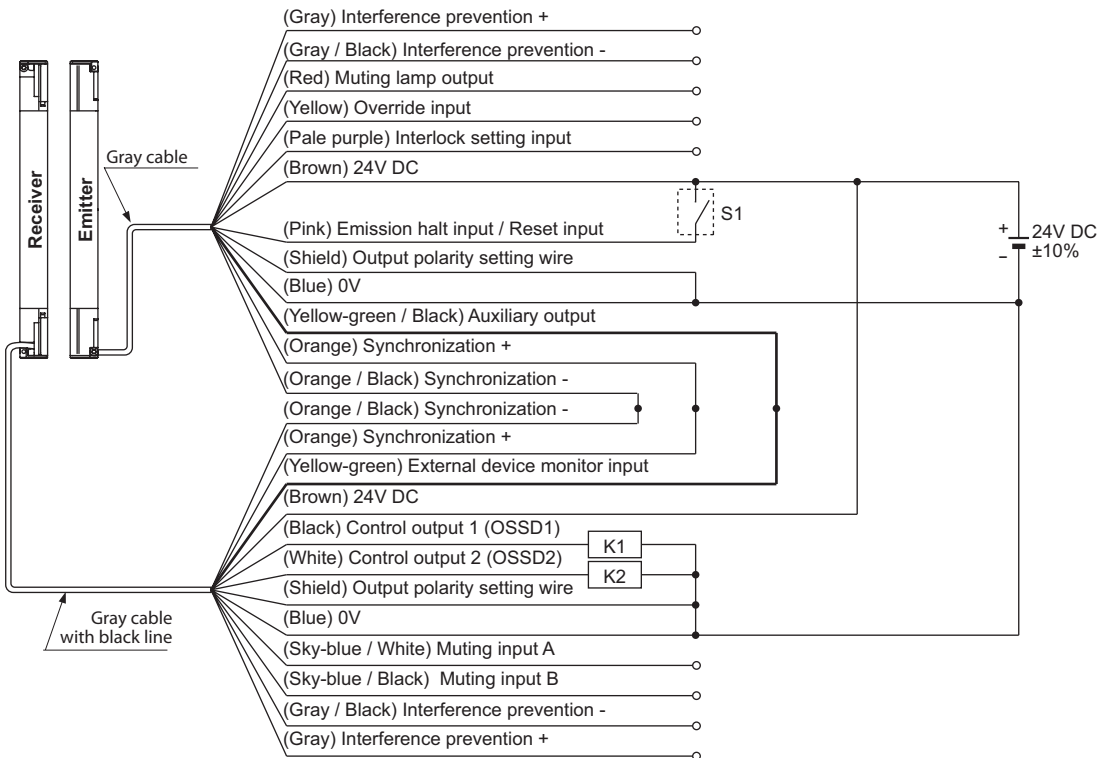

Symbols in the wiring diagram	
Switch S1	<ul style="list-style-type: none"> <li>• Vs to Vs - 2.5V (sink current: 5mA or less): Emission halt</li> <li>• Open: Emission</li> </ul>
K1, K2	External device (forcibly guided relay or magnetic contactor)

Vs = Applied supply voltage



**NOTE**

- The OSSD output type (PNP or NPN) is determined by the connecting state of the shield wire. Incorrect wiring may cause a lockout.
- The circuit diagrams shown above are for a 12-core cable. The 8-core cable uses the following wires: red, yellow, gray, gray/black, sky-blue/white, sky-blue/black. There is no lead wire.

**Wiring for NPN output when the external device monitor function is deactivated**

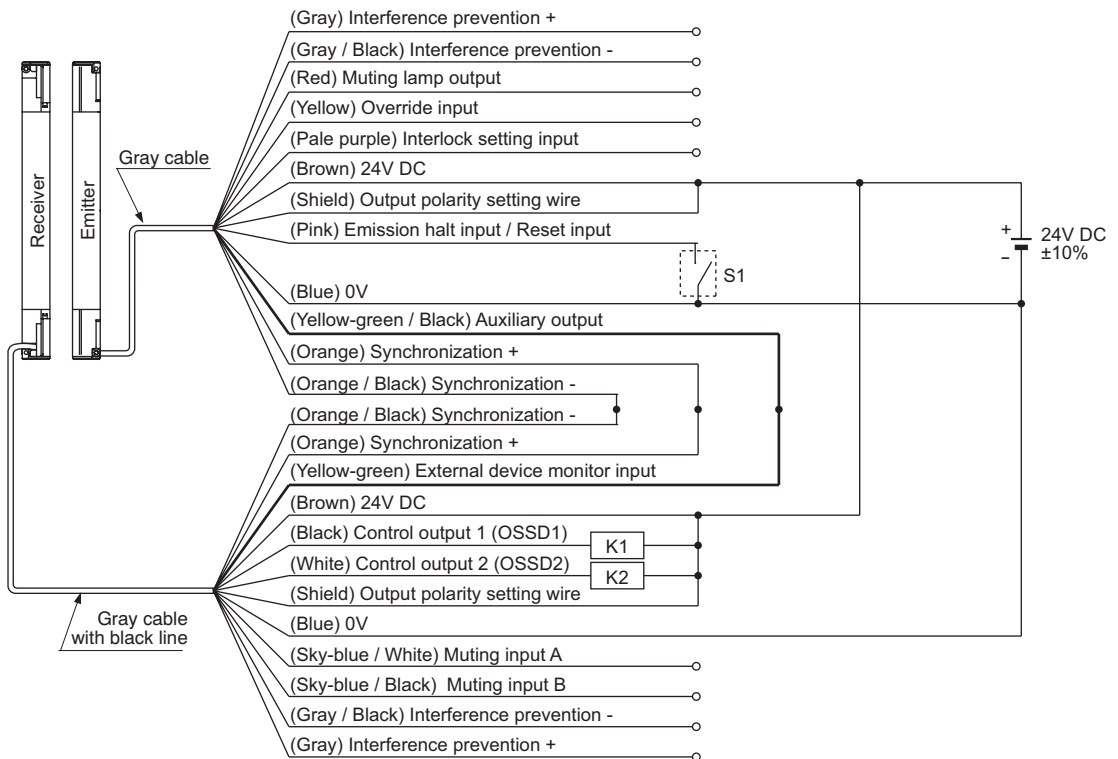

Symbols in the wiring diagram	
Switch S1	<ul style="list-style-type: none"> <li>• 0 to +1.5V (source current 5mA or less): Emission halt</li> <li>• Open: Emission</li> </ul>
K1, K2	External device (forcibly guided relay or magnetic contactor)



**NOTE**

- The OSSD output type (PNP or NPN) is determined by the connecting state of the shield wire. Incorrect wiring may cause a lockout.
- The circuit diagrams shown above are for a 12-core cable. The 8-core cable uses the following wires: red, yellow, gray, gray/black, sky-blue/white, sky-blue/black. There is no lead wire.

**2.6.7.7 Muting Function (Control Category 4)**

Feature	Setting
Interlock function (see page 75)	Deactivated (manual reset)
External device monitor function (see page 79)	Activated
Auxiliary output (see page 78)	Available

**Wiring for PNP output when the muting function is activated**

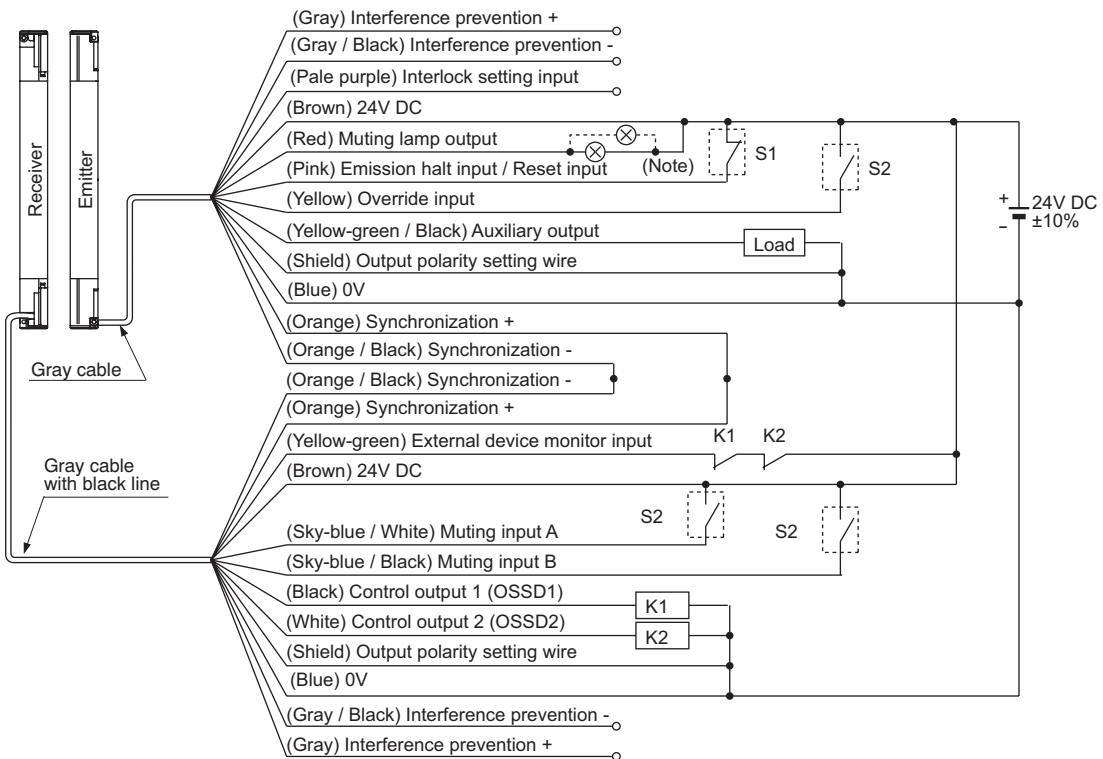

Symbols in the wiring diagram	
Switch S1	<ul style="list-style-type: none"> <li>• Vs to Vs - 2.5V (sink current: 5mA or less): Emission halt</li> <li>• Open: Emission</li> </ul>
Switch S2	Muting input, override input: <ul style="list-style-type: none"> <li>• Vs to Vs - 2.5V (sink current 5mA or less): Activated</li> <li>• Open: Deactivated</li> </ul>

Symbols in the wiring diagram	
K1, K2	External device (forcibly guided relay or magnetic contactor)

Vs = Applied supply voltage



**◆ NOTE**

**You must connect an incandescent lamp with 3 to 10W to the muting lamp output. If the muting lamp is not connected, the muting function does not work.**

**Wiring for NPN output when the muting function is activated**

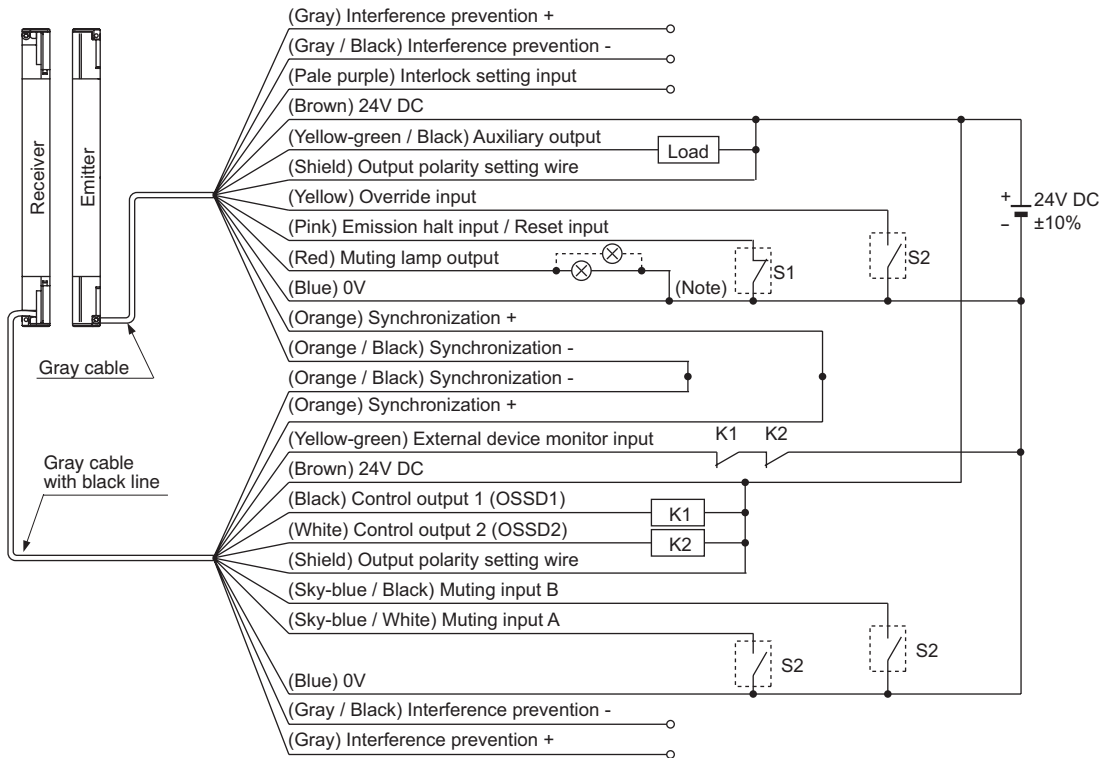

Symbols in the wiring diagram	
Switch S1	<ul style="list-style-type: none"><li>• 0 to +1.5V (source current 5mA or less): Emission halt</li><li>• Open: Emission</li></ul>
Switch S2	Muting input, override input: <ul style="list-style-type: none"><li>• 0 to +1.5V (source current 5mA or less): Activated</li><li>• Open: Deactivated</li></ul>
K1, K2	External device (forcibly guided relay or magnetic contactor)

**◆ NOTE**

**You must connect an incandescent lamp with 3 to 10W to the muting lamp output. If the muting lamp is not connected, the muting function does not work.**

## 2.7 Adjustment

---

The following sections contain information about the proper adjustment and operation of the safety light curtain.

You have to align the beam axis and test the light curtain in your application environment.

### 2.7.1 Beam-Axis Alignment

---

To align the beam axis, please proceed as follows:



#### ◆ Procedure

---

- 1. Turn ON the power supply unit of the safety light curtain**
- 2. Check that the digital error indicator (red) and the fault indicator (yellow) of the emitter and receiver are off**

If the digital error indicator (red) or the fault indicator (yellow) lights up or blinks, refer to the chapter on troubleshooting (see page 111) and report this to the maintenance staff in charge.
- 3. When you are using the intermediate supporting bracket (MS-SFB-2), loosen the two M5 hexagon-socket head bolts**
- 4. When you are using the standard mounting bracket (MS-SFB-1) for mounting this sensor, loosen the hexagon-socket head bolts for alignment of the standard mounting brackets and adjust the emitter and receiver so that they face each other**

There are marks engraved on part A. With the help of these marks, you can adjust the angle of the emitter/receiver in steps of 30 degrees.
- 5. Tighten the hexagon-socket head bolt for alignment of the standard mounting bracket**

The tightening torque should be 2N•m or less.
- 6. Loosen the hexagon-socket head bolt for beam axis alignment of the standard mounting bracket and adjust the emitter/receiver so that the beam-axis alignment indicators in the display of the emitter and receiver light up**

The emitter and the receiver can be adjusted  $\pm 15$  degrees.

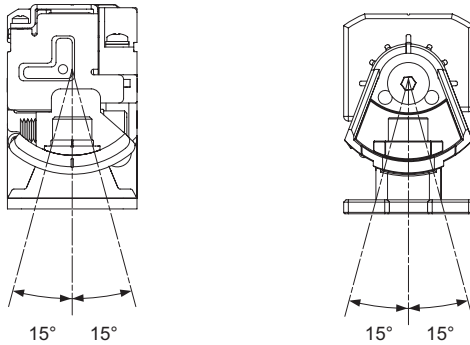

The beam-axis alignment indicator indicates the reception status for each section of a receiver. The receiver is divided into 4 sections. Also, the A (D) of the beam-axis alignment indicates the light-receiving status of the top end (bottom end) beam channel. For example, when using a 24-beam channel sensor, there are 6 beam channels per section (i.e.,  $24/4=6$ ). When the top end (bottom end) beam channel is received, the indicator A (D) of the beam-axis alignment blinks red. The following figure shows an example with 24 beam channels.

Only top end beam channel is received

5 beam channels including the top end beam channel are received

6 beam channels in top block are received

5 beam channels excluding the top end beam channel are received

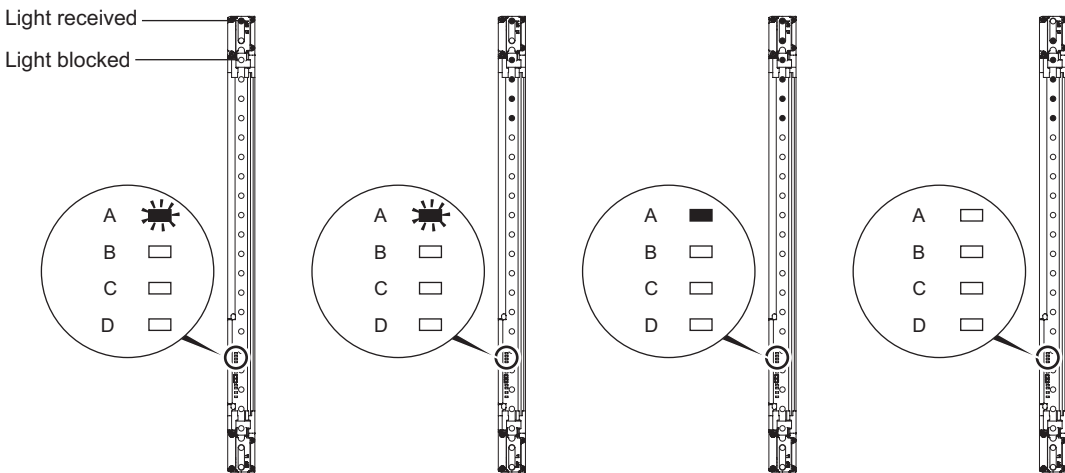

Symbols	●	: Received
	○	: Blocked
	☀	: Blinks
	■	: Lights up
	□	: Turns off

**7. After the adjustment, tighten the hexagon-socket head bolt for beam axis alignment of the standard mounting bracket**

The tightening torque should be 2N•m or less.

**8. Tighten the two intermediate supporting brackets**

9. Check again that the beam-axis alignment indicators in the display of the emitter and receiver light up

## 2.7.2 Operation Test

To test the installation, please proceed as follows:



### ◆ Procedure

1. Turn ON the power supply unit of the safety light curtain.
2. Check that the digital error indicator (red) and the fault indicator (yellow) of the emitter and the receiver are off.

If the digital error indicator (red) or the fault indicator (yellow) lights up or blinks, refer to the chapter on troubleshooting (see page 111) and report this to the maintenance staff in charge.

3. Move the test rod up and down at three positions, just in front of the emitter (A), in the middle between the emitter and receiver (B), and just in front of the receiver (C).

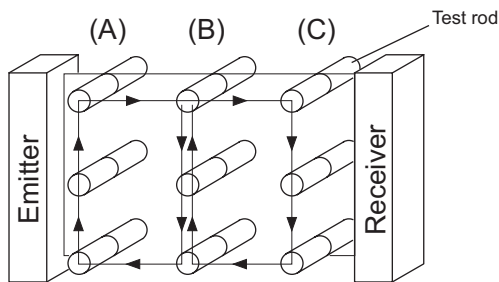

When you carry out step 3, check that the control outputs (OSSD 1, OSSD 2) are OFF and that both the OSSD indicator (red) of the receiver and the operation indicator (red) of the emitter light up as long as the test rod is present within the sensing area.

If the behavior of the control outputs (OSSD 1, OSSD 2) and the turning ON/OFF of the emitter/receiver indicators do not correspond to the movement of the test rod, refer to the chapter on troubleshooting (see page 111) and report this to the maintenance staff in charge.



### ◆ NOTE

If the indicators show reception of light even though the test rod blocks the light, check whether there is a reflective object or extraneous light source near this device.



# Chapter 3

---

# Functions

### **3.1 Self-Diagnosis Function**

---

The safety light curtain is equipped with a self-diagnosis function. Self-diagnosis is carried out when the power is turned ON and periodically during the operation.

In case an abnormality is detected during self-diagnosis, the device is immediately put in the lockout state and the control output (OSSD 1, OSSD 2) is set to OFF state. Find and remove the cause of the abnormality (see page 111).

### 3.2 Interlock Function

When the light curtain has been interrupted and control output (OSSD1, OSSD2) is OFF, the interlock function keeps the control output at OFF until a reset signal is input.

You can select whether interlock is enabled (manual reset) or disabled (automatic reset) by the way in which the interlock setting input line (pale purple) is connected.

You have to wire the SF4B accordingly to activate the interlock function and the manual reset. Without wiring the interlock function is disabled and auto reset is active.

Interlock function	Reset operation	Interlock setting input (pale purple)
Enabled	Manual reset	0V, +V connection
Disabled	Auto reset	Open

**Manual reset:** The control output (OSSD 1, OSSD 2) is not turned ON automatically even though this device receives light. When there is a signal at the reset input, the control output (OSSD 1, OSSD 2) is turned ON.

**Auto-reset:** The control output (OSSD 1, OSSD 2) is turned ON automatically when this device receives light.

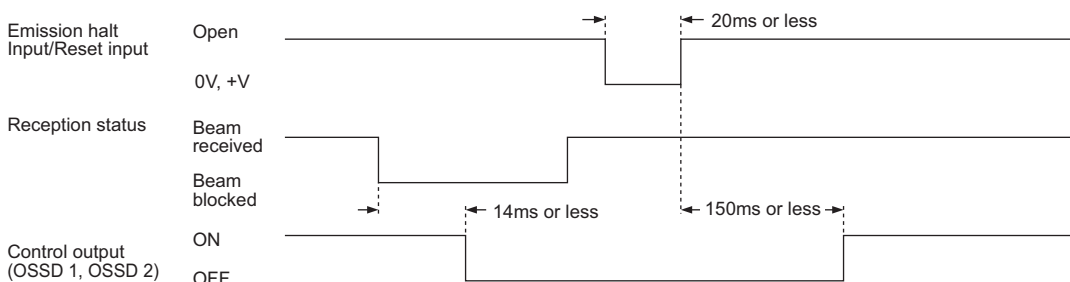

Time diagram for manual reset



**◆ NOTE**

- If this device is used with auto-reset, avoid an auto-restart after the safety output stop of the system by using a safety relay unit etc. (EN 60204-1).
- You can change the conditions for interlocking with the handy controller SFB-HC (optional).

### 3.3 Emission Halt Function

This function is used to test the functionality of the safety light curtain and the external devices. It stops the emission process of the emitter. You can select whether emission is on or halted by means of the connection status for the emission halt input/reset input wire (pink).

If the machinery is not stopped the cause may be a malfunction due to extraneous noise or an abnormality in the control output (OSSD 1/2) or the auxiliary output even from the machinery side.

Setting status of interlock function	Emission halt input/Reset input	Emission status
Enabled (auto reset)	Open	Emission halt
	0V, +V connection	Emission
Disabled (manual reset)	Open	Emission
	0V, +V connection	Emission halt

During emission halt, the control output (OSSD 1/2) turns OFF.

- Normal operation is restored when the emission halt input/reset input is connected to 0V or +V (for manual reset: Open).
- When the interlock function is disabled (automatic reset), normal operation is restored when the emission halt input/reset input wire (pink) is connected to 0V or +V.



**◆ NOTE**

The time diagram shows the operation in auto-reset mode. In manual reset mode, the device performs emission under status "Open" and performs emission halt under status "0V, +V".

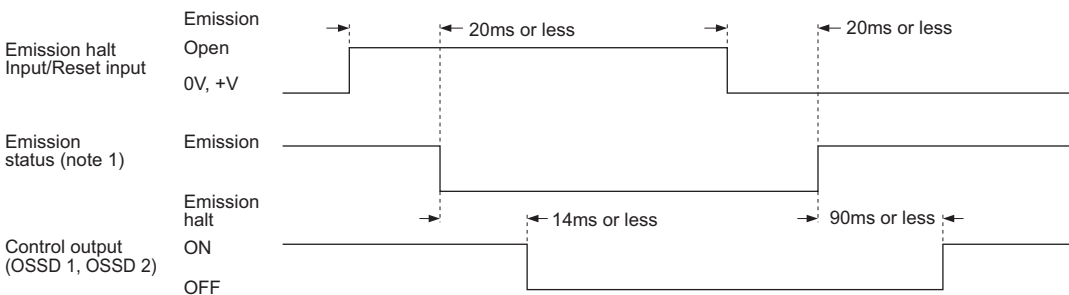

Time diagram in auto-reset mode



**DANGER!**

Do not use the emission halt function to stop the machine as this could result in serious injury or death.

## **3.4 Interference Prevention Function**

---

It is possible to construct the system in such a way that malfunction due to interference of light from other SF4B series devices is prevented. The interference prevention system works with up to three sets of sensors in series connection (see page 51). The maximum number of beam channels in series connection is 192.

### 3.5 Auxiliary Output (Non-Safety Output)

This device is equipped with an auxiliary output for non-safety-related purposes. The auxiliary output is incorporated with the emitter.

Auxiliary output setting	Normal mode			Lockout
	Emission halt	Control output (OSSD 1, OSSD 2) status		
		Beam received	Beam blocked	
Negative logic of OSSD (factory setting)	ON	OFF	ON	ON



**NOTE**

You can switch the output operation for auxiliary output with the handy controller SFB-HC (optional).

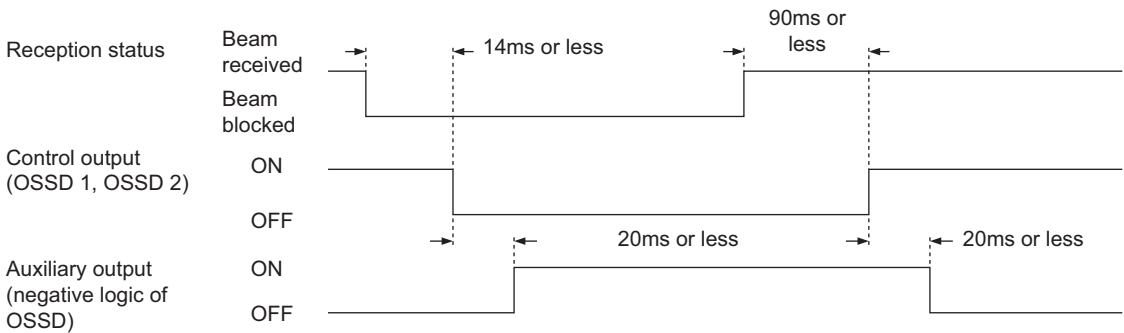

Time diagram



**DANGER!**

Do not use the auxiliary output to stop the machine as this could result in serious injury or death.

### 3.6 External Device Monitor Function

This is the function for checking whether the external safety relay connected to the control output (OSSD 1, OSSD 2) performs normally in accordance with the control output (OSSD 1, OSSD 2) or not. If any abnormality such as a deposit on the contacting point, etc. is detected, the status of the sensor changes to lockout and the control output (OSSD 1, OSSD 2) is turned to OFF.

- When the external device monitor function is activated:**  
 Connect the external device monitor input to the external safety relay of the control output (OSSD 1, OSSD 2).
- When the external device monitor function is deactivated:**  
 Connect the external device monitor input to the auxiliary output. By default, the auxiliary output is set to negative logic of the control output (OSSD 1, OSSD 2). The setting can be changed with the handy controller SFB-HC (optional). In this case, the auxiliary output cannot be connected to external devices.



**◆ NOTE**

**You can deactivate the external device monitor function or change the time range with the handy controller SFB-HC (optional).**

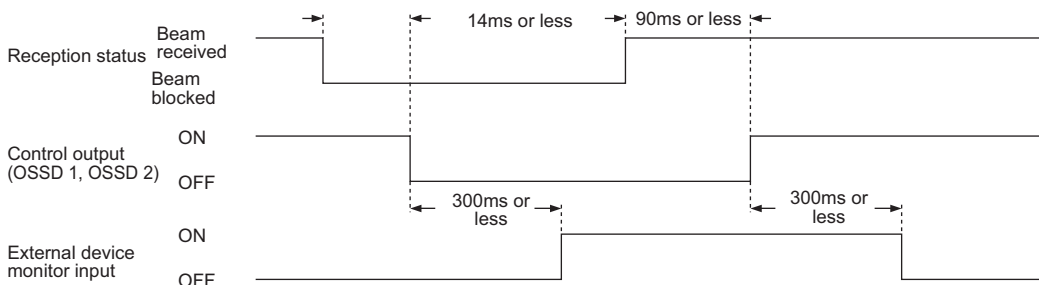

*Time diagram for normal operation*

If the device monitor function is active and an error occurs, it takes 300ms or less to set the device to lockout status. The time range can be set from 100 to 600ms (unit: 10ms) with the handy controller SFB-HC (optional).

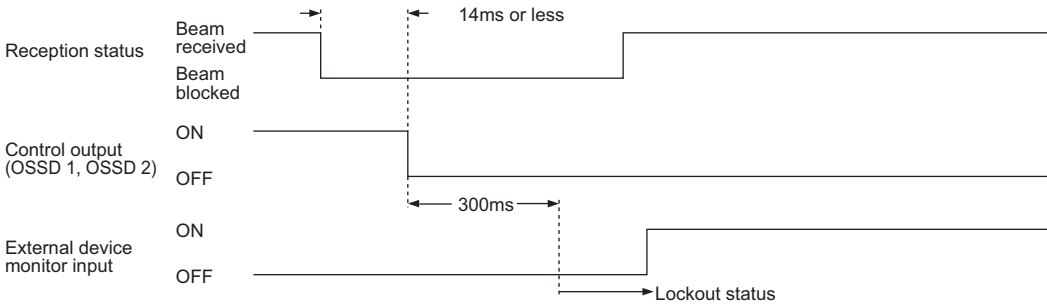

*Time diagram for error 1*

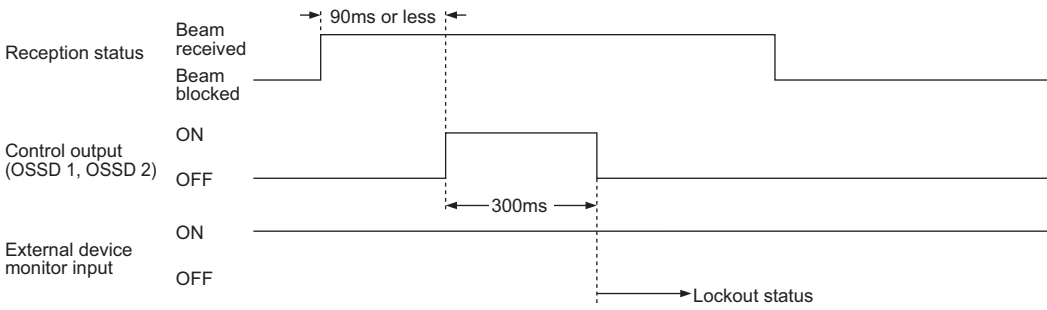

*Time diagram for error 2*



## 3.7 Muting Function

The muting function deactivates the protection function of the light curtain temporarily. You can activate the muting function only if no workpiece is in the sensing area, this means the control outputs (OSSD 1, OSSD 2) have to be ON.

This function is useful for passing workpieces through the sensing area of the light curtain without stopping the machinery.



### **DANGER!**

**Incorrect use of the muting function may cause accidents. Please study the muting function carefully before you use it.**

**Use the muting function while the machine cycle is not in danger mode. Maintain safety by using other measures while the muting control is activated.**

**For applications where the muting function is used when a workpiece passes through, place the muting sensors at such a distance that the muting function cannot be activated by personnel by accident.**

**Install the muting lamp in a position where it can always be seen by operators who configure or adjust the machine.**

**Be sure to check that the muting function is working properly before you use it in live operation. Furthermore, check the state of the muting lamp (cleanliness, brightness, etc.).**



### **◆ NOTE**

- The muting function complies with the requirements defined in the following international standards:
- ISO 13849-1 (EN 954-1/JIS B 9705-1): 'Safety of machinery - Safety-related parts of control systems - Part 1: General principles for design, Article 5.9 Muting'
- IEC 61496-1 (UL 61496/JIS B 9704-1): 'Safety of machinery - Electro sensitive protective equipment - Part 1: General requirements and tests' Annex A, A.7 Muting
- IEC 60204-1 (JIS B 9960-1): 'Safety of machinery - Electrical equipment of machines - Part 1: General requirements, 9.2.4 Overriding safeguards'
- EN 415-4: 'Safety of packaging machines part 4. Palletizers and depalletizers' Annex A, A2.2 Muting'
- ANSI B11.19-1990: 'for Machine Tools-Safeguarding When Referenced by the Other B11 Machine Tool Safety Standards-Performance Criteria for the

### Design, Construction, Care, and Operation' 4.2.3 Presence-Sensing Devices: Electro-Optical and Radio Frequency (R.F.)

- **ANSI/RIA R15.06-1999: 'for Industrial Robots and Robot Systems - Safety Requirements, 10.4.5 Muting'**

The muting function is active when all the conditions listed below are satisfied:

- The control output (OSSD 1, OSSD 2) is ON.
- The incandescent lamp with 3 to 10W is connected to the muting lamp output.
- The output of the muting sensors A, B, C, and D switch from OFF (open) to ON in a time range of 0.03 to 3 seconds.

Photoelectric sensors with semiconductor output, inductive proximity sensors, position switches on NO (Normal Open) contacting point, etc. can be used as muting sensors.



#### ◆ NOTE

Normally the diagnosis function for controlling the muting lamp is activated. With the handy controller SFB-HC (optional) you can determine that the muting functions works even if no muting lamp is connected or the muting lamp has burned out.

### 3.7.1 Specification for the Muting Sensor

The muting sensors can be photoelectric sensors, inductive proximity sensors, or position switches etc. They have to be in the ON state if an object is sensed. For NPN output this means 0V, for PNP output +V.



#### DANGER!

Only use a device that satisfies the specification for the muting sensor mentioned above. If you use a different device that does not meet the requirements of a muting sensor, the muting function may operate with a different timing than expected, which could result in serious injury or death.

Always connect a muting lamp to make the status of the function visible. It is forbidden to activate the muting function if no muting lamp is connected.

### 3.7.2 Installation of the Muting Sensor

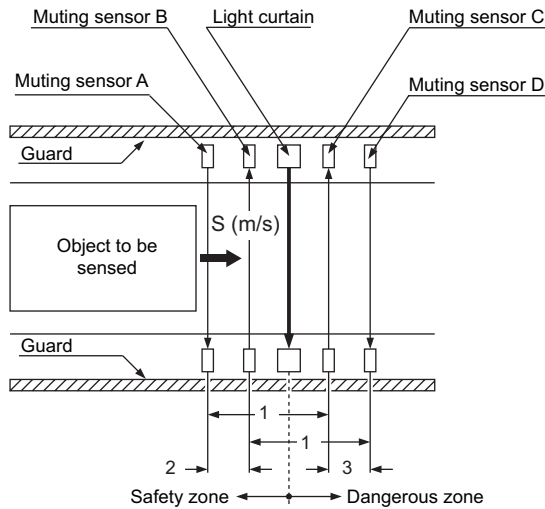

1. The distance between muting sensors A to C and between B to D must be shorter than the whole length of the object to be sensed.
2. The distance between muting sensors A to B has to be covered by the object to be sensed in 30ms to 3 seconds. ( $S = \text{speed}$ )  
Distance between A and B:  $S \times 3 \text{ (s)}$
3. The distance between muting sensors C to D has to be covered by the object to be sensed in less than 3 seconds.  
Distance between C and D:  $S \times 3 \text{ (s)}$

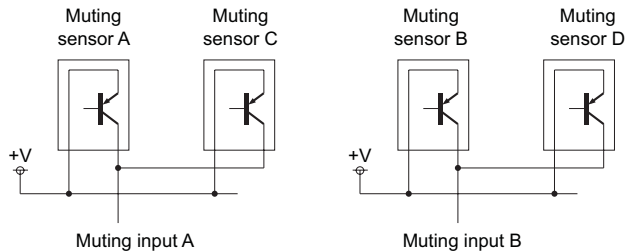

#### Installing the muting sensor with PNP output

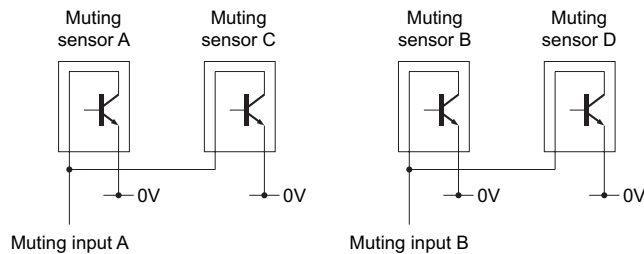

#### Installing the muting sensor with NPN output

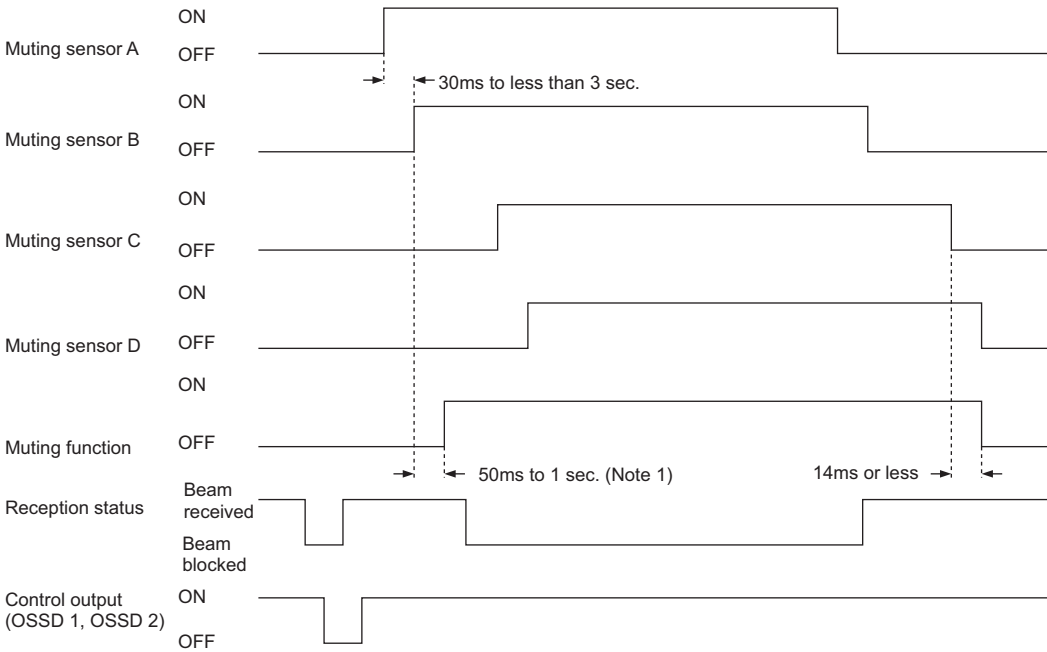

Time diagram of the muting function



◆ NOTE

- **When the diagnosis function for the muting lamp is active: If the muting lamp does not light up after 1s, the muting function is deactivated. When diagnosis function for the muting lamp is not active: The muting function is activated with a delay of 50ms after the input conditions of the muting sensor A (C) and B (D) are satisfied.**
- **You can deactivate the muting function per beam channel and to specify the activation order of the muting sensor with the handy controller SFB-HC (optional).**
- **We recommend connecting two muting lamps in parallel. Do not exceed 10W.**

## 3.8 Override Function

---

This function enables you to override the machine stop signal and to enter the muting state. It is used to restart the system smoothly when the sequence of operations is incorrect or in case of power loss.

If this function is used, it forcibly deactivates the safety function of the light curtain. The override function is used when the muting function is active, something happened which stopped the operation (as described above) and the operation then needs to be restarted again with the control output (OSSD 1, OSSD 2) in OFF status (e.g. there is still some material in the detection field of this device which needs to be moved out of the detection field before the safety function can be reactivated).



### **DANGER!**

**Incorrect use of the muting function may cause accidents. Please study the muting function carefully before you use it.**

**Use the muting function while the machine cycle is not in danger mode. Maintain safety by using other measures while the muting function is activated.**

**For applications where the muting function is used when a workpiece passes through, place the muting sensors at such a distance that the muting function cannot be activated by personnel by accident.**

**Install the muting lamp in a position where it can always be seen by operators who configure or adjust the machine.**

**Be sure to check that the muting function is working properly before you use it in live operation. Furthermore, check the state of the muting lamp (cleanliness, brightness, etc.).**



### **◆ NOTE**

---

- The muting function complies with the requirements defined in the following international standards.
- ISO 13849-1 (EN 954-1/JIS B 9705-1): 'Safety of machinery - Safety-related parts of control systems - Part 1: General principles for design, Article 5.9 Muting'
- IEC 61496-1 (UL 61496/JIS B 9704-1): 'Safety of machinery - Electro sensitive protective equipment - Part 1: General requirements and tests' Annex A, A.7 Muting
- IEC 60204-1 (JIS B 9960-1): 'Safety of machinery - Electrical equipment of machines - Part 1: General requirements, 9.2.4 Overriding safeguards'
- EN 415-4: 'Safety of packaging machines part 4. Palletizers and depalletizers' Annex A, A2.2 Muting'

- **ANSI B11.19-1990: 'for Machine Tools-Safeguarding When Referenced by the Other B11 Machine Tool Safety Standards-Performance Criteria for the Design, Construction, Care, and Operation' 4.2.3 Presence-Sensing Devices: Electro-Optical and Radio Frequency (R.F.)**
- **ANSI/RIA R15.06-1999: 'for Industrial Robots and Robot Systems - Safety Requirements, 10.4.5 Muting'**

The override function is active when all the conditions listed below are satisfied:

- The incandescent lamp with 3 to 10W is connected to the muting lamp output.
- The override signal is input from either the muting sensor A or B.
- The override input is connected to 0V or +V, and the emission halt input/reset input is opened (for 3 seconds)

If any of the three conditions above is not satisfied or takes longer than 60 seconds, the override function is deactivated.



---

**◆ NOTE**

---

- **Normally the diagnosis function for controlling the muting lamp is activated. With the handy controller SFB-HC (optional) you can determine that the muting functions works even if no muting lamp is connected or the muting lamp has burned out.**
- **The override function operates only when auto-reset is ON (the interlock function is disabled).**

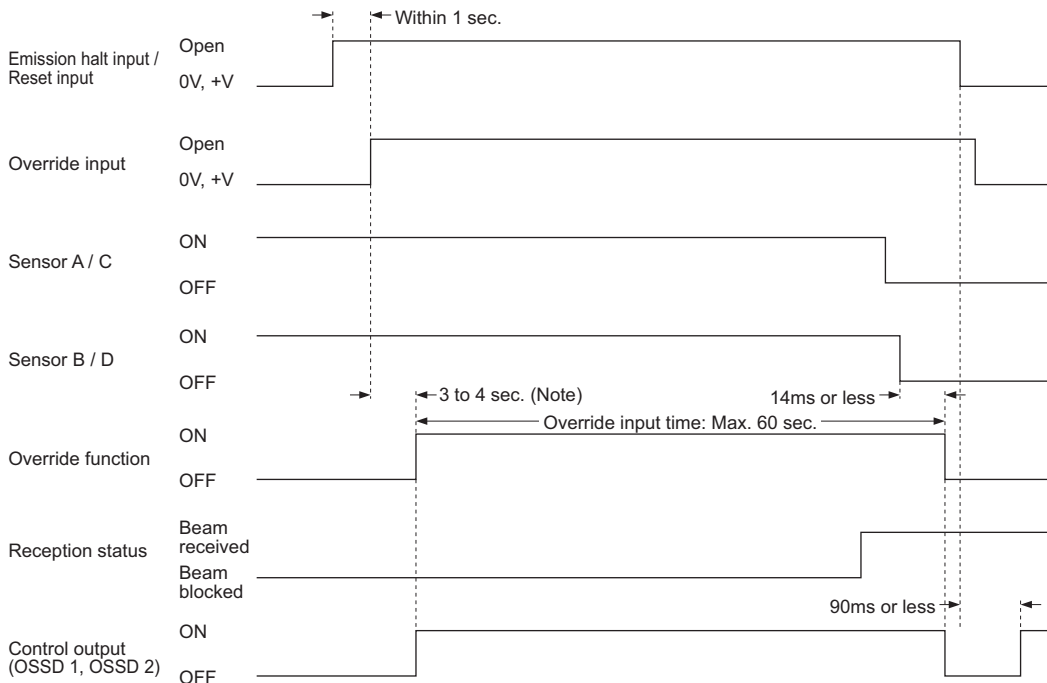

Time diagram for the override function



◆ NOTE

**When the diagnosis function for the muting lamp is active: If the muting lamp does not light up after 1s, the muting function is deactivated.**  
**When the diagnosis function for the muting lamp is not active: The muting function starts 3s after the input conditions of the muting sensor A (C) and B (D) are satisfied.**

### 3.9 Functions of the Optional Handy Controller SFB-HC

You can set the following functions with the handy controller SFB-HC (optional). For details, refer to the instruction manual enclosed with the handy controller.



**DANGER!**

Please note that the safety distance, the size of the minimum object to be sensed, the response speed, etc. may differ depending on the function. When you set each function, recalculate the safety distance and install the device at a distance larger than the safety distance. Not keeping the distance may result in a situation where the machine does not stop quickly enough, resulting in serious bodily injury or death.

Function	Details
<b>Fixed blanking</b> [Fixed blanking]	This function prevents the control output (OSSD 1, OSSD 2) from turning OFF even though the specific beam channel is blocked. By default, the fixed blanking function is not active. (Note 1)
<b>Floating blanking</b> [Floating blanking]	This function prevents the control output (OSSD 1, OSSD 2) from turning OFF as long as not more than the set number of beam channels are blocked. The position of the blocked beam channels does not matter. You can set the floating blanking function for 1, 2, or 3 beam channels. By default, the floating blanking function is not active. (Note 1)
<b>Emission intensity control</b> [Light emission control]	The emission intensity control function offers two modes, normal mode and short mode. The factory setting is normal mode.
<b>Auxiliary output switching (non-safety output)</b> [Auxiliary output]	The auxiliary output can be switched to execute the following functions: 0. Negative logic of the control output (OSSD 1, OSSD 2) (factory setting) 1. Positive logic of the control output (OSSD 1, OSSD 2) 2. For emission: output ON, for non-emission: output OFF 3. For emission: output OFF, for non-emission: output ON 4. For unstable incident beam: OFF (Note 2) 5. For unstable incident beam: ON (Note 2) 6. For muting: ON 7. For muting: OFF 8. For beam reception: ON, for beam blocked: OFF (Note 3) 9. For beam reception: OFF, for beam blocked: ON (Note 3)
<b>Interlock setting</b> [Inter Lock]	Select one from the following three interlock settings.
<b>Start/Restart interlock</b>	The sensor goes into interlock state after the power is turned on or when the light is blocked. This is the factory setting.
<b>Start interlock</b>	The sensor goes into interlock state when the power supply is turned on. Once the interlock state is reset, the device does not go into the interlock state again.
<b>Restart interlock</b>	The sensor does not go into the interlock state when the power supply is turned on. Only when the control output (OSSD 1, OSSD 2) turns ON and the light is blocked, the sensor goes into the interlock state.
<b>External device monitor setting</b>	You can make the following settings for the external device monitor: Permissible response time: 100 to 600ms (unit: 10ms). The factory setting is 300ms. The external



Function	Details
[Device Monitor]	device monitor function is activated/deactivated. The factory setting is activated.
Muting setting [Muting]	<p>You can make the following settings for the muting function:</p> <ul style="list-style-type: none"> <li>When the muting function is active, you can specify the output order of the muting sensors A and B.</li> <li>You can activate the muting function per beam channel (Note 4). By default, the muting function is active for all beam channels.</li> <li>The diagnosis function for the muting lamp can be activated/deactivated (Note 5). The factory setting is activated.</li> <li>The output operation of a muting sensor which is to be connected to the muting input of the sensor can be set with the handy controller SFB-HC . The factory setting for the output operation is NONO (Normally Open, Normally Open, Note 6).</li> </ul>
Password protection [Protect]	When this function is active, you need to enter the password to change the settings of the sensor. The factory setting is deactivated.
Override setting function	You can set the maximum time for the override function in the range of 60 to 600 seconds in steps of 10 seconds (Note 5).



◆ **NOTE**

- The fixed blanking function and floating blanking function can be set at the same time.**
- The auxiliary output cannot be used when the functions fixed blanking, floating blanking or muting are activated.**
- Functions 8 and 9 cannot be used when you have activated one of the following functions: fixed blanking, floating blanking , and muting.**
- If a beam channel is blocked that is not set during the muting function, the muting function will be deactivated and the control output (OSSD 1, OSSD 2) is turned off.**
- This function can only be set with a handy controller SFB-HC (optional) where software version 2 or later is installed. The function cannot be set with a handy controller with the software version 1.**
- The factory setting for the output operation is NONO (Normally Open, Normally Open). You can set the output operation to NONC (Normally Open, Normally Closed). Connect a sensor or switch with an output operation of NO (Normally Open) to muting input A and a sensor or switch with an output operation of NC (Normally Closed) to muting input B. To activate the muting function, the time between the muting input A turning ON from OFF (= open state) and the muting input B turning OFF (= open state) from ON must be no longer than 3 seconds. The output operation for NONC works as follows:**

	Muting input	Operation at ON state	Operation at OFF state
<b>NO (Normally Open) type:</b> <ul style="list-style-type: none"> <li>ON when no light is received (photoelectric sensor, etc.)</li> </ul>			

	Muting input	Operation at ON state	Operation at OFF state
<ul style="list-style-type: none"> <li>ON when object is approaching (inductive proximity sensor, etc.)</li> <li>ON when object has contact (position switch, etc.)</li> </ul>	A	0V or 24V DC	Open
<p><b>NC (Normally Closed) type:</b></p> <ul style="list-style-type: none"> <li>ON when light is received (photoelectric sensor, etc.)</li> <li>ON when no object is approaching (inductive proximity sensor, etc.)</li> <li>ON when no object has contact (position switch, etc.)</li> </ul>	B		





# Chapter 4

---

# Operation

## 4.1 Normal Operation

























The status of the emitter/receiver indicators during normal operation is as described as follows.















































Indicator symbol	Explanation
	Blinks red
	Lights up red
	Lights up green
	Lights up orange
	OFF



### ◆ NOTE

1. Since the color of the operation indicator changes according to whether the control outputs (OSSD 1, OSSD 2) are ON or OFF, the operation indicator on the light curtain is marked 'OSSD'.
2. The following table shows the status of the emitter/receiver indicators during operation when you are using a PNP output. When you are using an NPN output, the NPN indicator lights up orange.

Beam status	Indicators		Control output
	Emitter	Receiver	OSSD 1/OSSD 2
All beams received	Lights up green  Beam-axis alignment indicator [RECEPTION] (Green)      Operation indicator [OSSD] (Green) (Note 1)  Incident beam intensity indicator [STB] (Green)  Fault indicator [FAULT]   Digital error indicator   PNP indicator [PNP] (Orange) (Note 2)  NPN indicator [NPN]   Emission intensity control indicator [CTRL]  Emission halt indicator [HALT] 	Lights up green  Beam-axis alignment indicator [RECEPTION] (Green)      OSSD indicator [OSSD] (Green)  Incident beam intensity indicator [STB] (Green)  Fault indicator [FAULT]   Digital error indicator   PNP indicator [PNP] (Orange) (Note 2)  NPN indicator [NPN]   Function setting indicator [FUNCTION]  Interlock indicator [INTERLOCK] 	ON

Beam status	Indicators		Control output
	Emitter	Receiver	OSSD 1/OSSD 2
One or more beams blocked	<p>Lights up red (OFF for channels where the beam is blocked)</p> <p>Beam-axis alignment indicator [RECEPTION] (Red)    </p> <p>Operation indicator [OSSD] (Red) (Note 1) </p> <p>Incident beam intensity indicator [STB] </p> <p>Fault indicator [FAULT] </p> <p>Digital error indicator </p> <p>PNP indicator [PNP] (Orange) (Note 2) </p> <p>NPN indicator [NPN] </p> <p>Emission intensity control indicator [CTRL] </p> <p>Emission halt indicator [HALT] </p>	<p>Lights up red (OFF for channels where the beam is blocked)</p> <p>Beam-axis alignment indicator [RECEPTION] (Red)    </p> <p>OSSD indicator [OSSD] (Red) </p> <p>Incident beam intensity indicator [STB] </p> <p>Fault indicator [FAULT] </p> <p>Digital error indicator </p> <p>PNP indicator [PNP] (Orange) (Note 2) </p> <p>NPN indicator [NPN] </p> <p>Function setting indicator [FUNCTION] </p> <p>Interlock indicator [INTERLOCK] </p>	OFF
Beams other than the top end blocked	<p>The topmost beam-axis alignment indicator: Blinks red</p> <p>Operation indicator: Lights up red</p> <p>Beam-axis alignment indicator [RECEPTION] (Red)   </p> <p>Operation indicator [OSSD] (Red) (Note 1) </p> <p>Incident beam intensity indicator [STB] </p> <p>Fault indicator [FAULT] </p> <p>Digital error indicator </p> <p>PNP indicator [PNP] (Orange) (Note 2) </p> <p>NPN indicator [NPN] </p> <p>Emission intensity control indicator [CTRL] </p> <p>Emission halt indicator [HALT] </p>	<p>The topmost beam-axis alignment indicator: Blinks red</p> <p>OSSD indicator: Lights up red</p> <p>Beam-axis alignment indicator [RECEPTION] (Red)   </p> <p>OSSD indicator [OSSD] (Red) </p> <p>Incident beam intensity indicator [STB] </p> <p>Fault indicator [FAULT] </p> <p>Digital error indicator </p> <p>PNP indicator [PNP] (Orange) (Note 2) </p> <p>NPN indicator [NPN] </p> <p>Function setting indicator [FUNCTION] </p> <p>Interlock indicator [INTERLOCK] </p>	OFF

Beam status	Indicators		Control output
	Emitter	Receiver	OSSD 1/OSSD 2
Beams other than the bottom end blocked	<p>The bottommost beam-axis alignment indicator: Blinks red</p> <p>Operation indicator: Lights up red</p> <p>Beam-axis alignment indicator [RECEPTION] (Red)</p> <p>Operation indicator [OSSD] (Red) (Note 1)</p> <p>Incident beam intensity indicator [STB]</p> <p>Fault indicator [FAULT]</p> <p>Digital error indicator</p> <p>PNP indicator [PNP] (Orange) (Note 2)</p> <p>NPN indicator [NPN]</p> <p>Emission intensity control indicator [CTRL]</p> <p>Emission halt indicator [HALT]</p>	<p>The bottommost beam-axis alignment indicator: Blinks red</p> <p>OSSD indicator: Lights up red</p> <p>Beam-axis alignment indicator [RECEPTION] (Red)</p> <p>OSSD indicator [OSSD] (Red)</p> <p>Incident beam intensity indicator [STB]</p> <p>Fault indicator [FAULT]</p> <p>Digital error indicator</p> <p>PNP indicator [PNP] (Orange) (Note 2)</p> <p>NPN indicator [NPN]</p> <p>Function setting indicator [FUNCTION]</p> <p>Interlock indicator [INTERLOCK]</p>	

**Time chart**

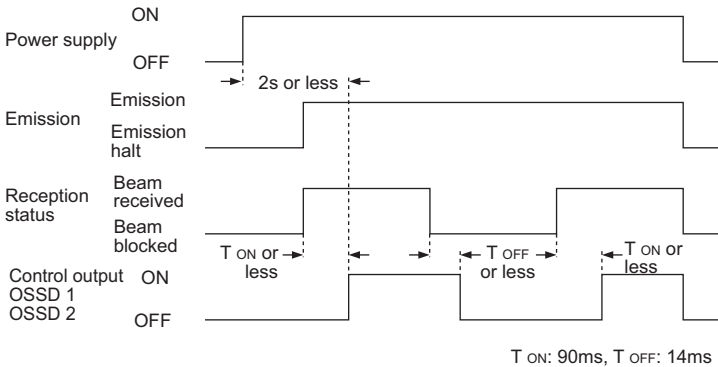

**Series Connection**

When you have connected several sensor systems in series and the light is blocked for one of the systems, the control outputs (OSSD 1, OSSD 2) turn OFF.



**◆ NOTE**

**The emitter/receiver indicators indicate the output status.**

The following figure shows the status of the indicators when the light is blocked for Subsystem A2.

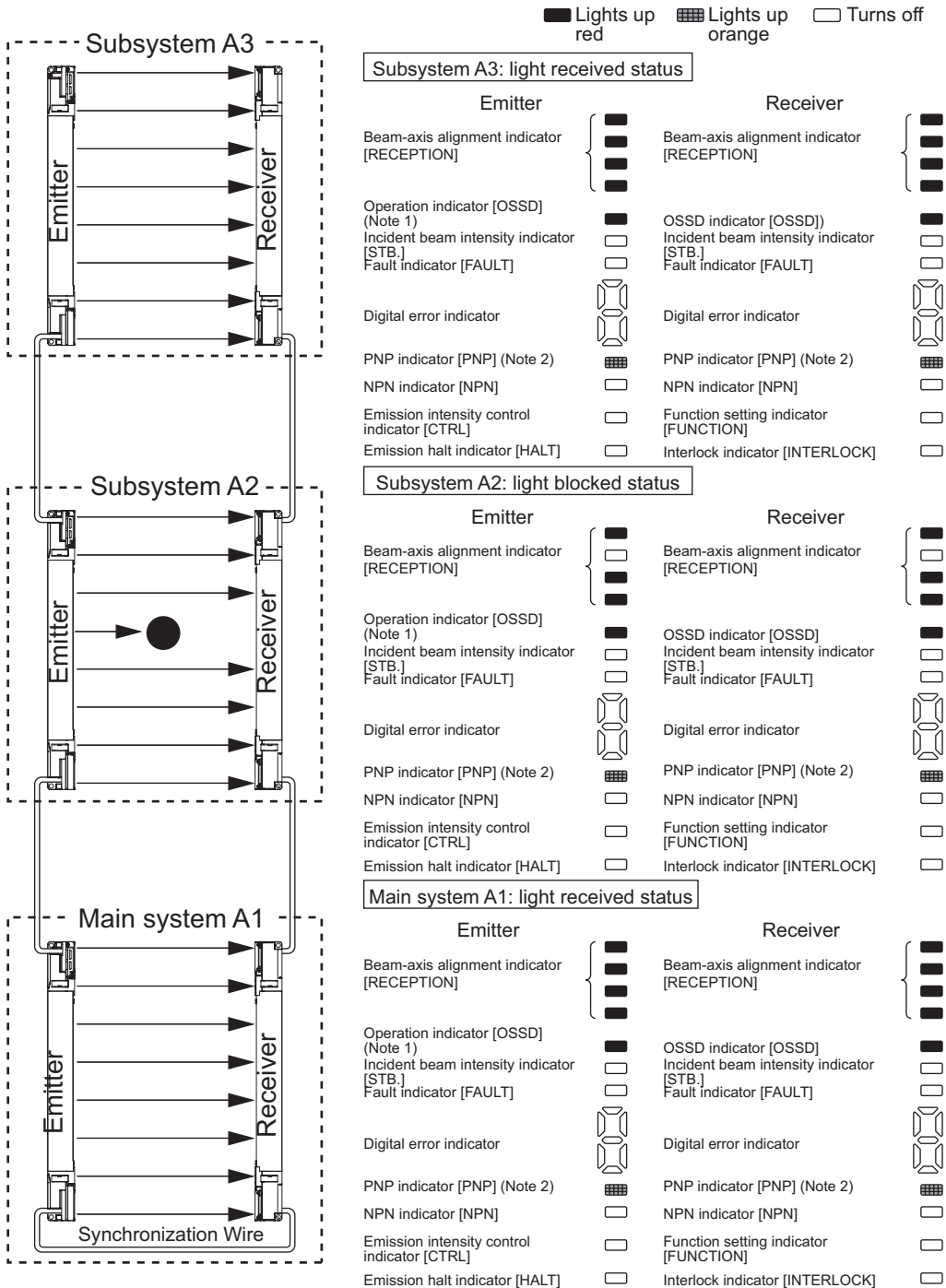

**◆ NOTE**

---

---

1. Since the color of the operation indicator changes according to whether the control outputs (OSSD 1, OSSD 2) are ON or OFF, the operation indicator on the light curtain is marked 'OSSD'.
2. The figure shows the status of the emitter/receiver indicators during operation when you are using a PNP output. When you are using an NPN output, the NPN indicator lights up orange.

**Parallel Connection**

When you have connected several light curtain systems in parallel and the light is blocked for one of the systems, only the output of the light curtain in status "light blocked" turns OFF.

**◆ NOTE**

---

---

**The emitter/receiver indicators indicate the output status.**



The following figure shows the status of the indicators with the Slave side 1 sensor in light blocked status.

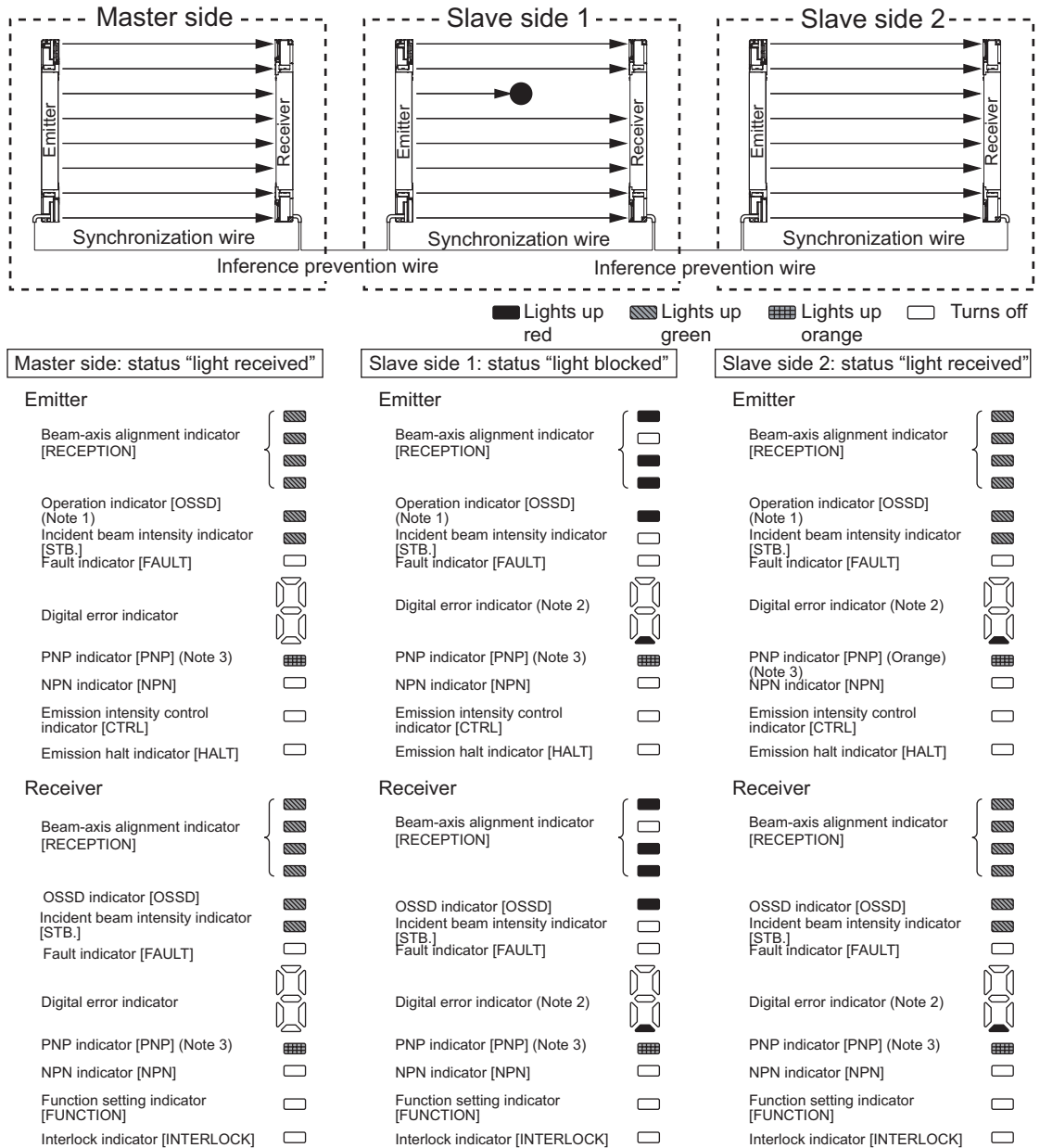

◆ NOTE

1. Since the color of the operation indicator changes according to whether the control outputs (OSSD 1, OSSD 2) are ON or OFF, the operation indicator on the light curtain is marked 'OSSD'.

- 2. When the sensors are connected in parallel, the bottom of the digital error indicator on the slave side lights up red. However, when the sensors are connected in series, only the indicator of the main side sensor lights up.**
- 3. The figure shows the status of the emitter/receiver indicators during operation when you are using a PNP output. When you are using an NPN output, the NPN indicator lights up orange.**

## 4.2 Using the Emission Halt Function

The safety light curtain incorporates the emission halt function. With this function you can simulate the status when the beam is blocked.













































































**◆ NOTE**

1. When the emission halt input is kept open (for manual reset: connected to 0V, +V), the emitter stops emitting light. In this condition, if this device operates properly, the control output (OSSD 1, OSSD 2) of the receiver turns OFF.
2. Since the color of the operation indicator changes according to whether the control output (OSSD 1, OSSD 2) is ON or OFF, the operation indicator on the light curtain is marked 'OSSD'.
3. The following table shows the status of the emitter/receiver indicators during operation when you are using an PNP output. When you are using an NPN output, the NPN indicator lights up orange.

Indicator symbol	Explanation
	Blinks orange
	Lights up red
	Lights up green
	Lights up orange
	Is OFF

Setting procedure and check items		Indicators		Control output
		Emitter	Receiver	OSSD1 OSS2
1	Before power is ON: Connect the emission halt input to the supply voltage	Beam-axis alignment indicator [RECEPTION] Operation indicator [OSSD] (Note 1) Incident beam intensity indicator [STB] Fault indicator [FAULT]  Digital error indicator  PNP indicator [PNP] NPN indicator [NPN]  Emission intensity control indicator [CTRL] Emission halt indicator [HALT]	Beam-axis alignment indicator [RECEPTION]  Operation indicator [OSSD] Incident beam intensity indicator [STB] Fault indicator [FAULT]  Digital error indicator  PNP indicator [PNP] NPN indicator [NPN]  Function setting indicator [FUNCTION] Interlock indicator [INTERLOCK]	OFF





Setting procedure and check items		Indicators		Control output
		Emitter	Receiver	OSSD1 OSS2
2	After power is ON: Receiver's control output (OSSD 1, OSSD 2) is ON (normal operation)	Beam-axis alignment indicator [RECEPTION] (Green)     Operation indicator [OSSD] (Green) (Note 1)  Incident beam intensity indicator [STB] (Green)  Fault indicator [FAULT]  Digital error indicator  PNP indicator [PNP] (Orange) (Note 2)  NPN indicator [NPN]  Emission intensity control indicator [CTRL]  Emission halt indicator [HALT] 	Beam-axis alignment indicator [RECEPTION] (Green)     OSSD indicator [OSSD] (Green)  Incident beam intensity indicator [STB] (Green)  Fault indicator [FAULT]  Digital error indicator  PNP indicator [PNP] (Orange) (Note 2)  NPN indicator [NPN]  Function setting indicator [FUNCTION]  Interlock indicator [INTERLOCK] 	ON
3	Open the emission halt input Receiver's control output (OSSD 1, OSSD 2) is OFF (Emission halt, normal operation)	Beam-axis alignment indicator [RECEPTION]     Operation indicator [OSSD] (Red) (Note 1)  Incident beam intensity indicator [STB]  Fault indicator [FAULT]  Digital error indicator  PNP indicator [PNP] (Orange) (Note 2)  NPN indicator [NPN]  Emission intensity control indicator [CTRL]  Emission halt indicator [HALT] (Orange) 	Beam-axis alignment indicator [RECEPTION]     OSSD indicator [OSSD] (Red)  Incident beam intensity indicator [STB]  Fault indicator [FAULT]  Digital error indicator  PNP indicator [PNP] (Orange) (Note 2)  NPN indicator [NPN]  Function setting indicator [FUNCTION]  Interlock indicator [INTERLOCK] 	OFF



















Setting procedure and check items		Indicators		Control output
		Emitter	Receiver	OSSD1 OSS2
4	<p>Connect the emission halt input to Vs (Note 3)</p> <p>Receiver's control output (OSSD 1, OSSD 2) is ON (normal operation)</p>	<p>Beam-axis alignment indicator [RECEPTION] (Green)    </p> <p>Operation indicator [OSSD] (Green) (Note 1) </p> <p>Incident beam intensity indicator [STB] (Green) </p> <p>Fault indicator [FAULT] </p> <p>Digital error indicator  </p> <p>PNP indicator [PNP] (Orange) (Note 2) </p> <p>NPN indicator [NPN] </p> <p>Emission intensity control indicator [CTRL] </p> <p>Emission halt indicator [HALT] </p>	<p>Beam-axis alignment indicator [RECEPTION] (Green)    </p> <p>OSSD indicator [OSSD] (Green) </p> <p>Incident beam intensity indicator [STB] (Green) </p> <p>Fault indicator [FAULT] </p> <p>Digital error indicator  </p> <p>PNP indicator [PNP] (Orange) (Note 2) </p> <p>NPN indicator [NPN] </p> <p>Function setting indicator [FUNCTION] </p> <p>Interlock indicator [INTERLOCK] </p>	ON

### 4.3 When an Error Occurs

If a sensor error is detected, the sensor will turn the control output (OSSD 1, OSSD 2) OFF, the digital error indicator (red) on the receiver lights up and the fault indicator (yellow) on the emitter and receiver lights up or blinks.

- If an emitter error is detected, the emitter will be locked out, stopping its emission, and the control output (OSSD 1, OSSD 2) will be turned OFF.
- If a receiver error is detected, the receiver will be locked out, and the control output (OSSD 1, OSSD 2) will be turned OFF. Also, the emission halt indicator (orange) of the emitter blinks.

Indicator symbol	Explanation
	Blinks yellow
	Lights up red
	Lights up green
	Lights up orange
	Is OFF

Emitter		Receiver	
Beam-axis alignment indicator [RECEPTION]		Beam-axis alignment indicator [RECEPTION]	
Operation indicator [OSSD] (note 1)		OSSD indicator [OSSD]	
Incident beam intensity indicator [STB]		Incident beam intensity indicator [STB]	
Fault indicator [FAULT] (yellow)		Fault indicator [FAULT] (Yellow)	
Digital error indicator (red) (note 2)		Digital error indicator (Red) (Note 2)	
PNP indicator [PNP] (orange) (note 3)		PNP indicator [PNP] (Orange) (Note 3)	
NPN indicator [NPN]		NPN indicator [NPN]	
Emission intensity control indicator [CTRL]		Function setting indicator [FUNCTION]	
Emission halt indicator (orange) [HALT]		Interlock indicator [INTERLOCK]	



**◆ NOTE**

1. For details on the digital error indicator, refer to the chapter on troubleshooting (see page 111).
2. Since the color of the operation indicator changes according to the ON/OFF state of the control output (OSSD 1, OSSD 2), the operation indicator is marked as 'OSSD' on the light curtain.

Since this device will not return to normal operation automatically after the error is corrected, it is necessary to turn the power off and on again. Possible sources of error: short-circuit in control

output (OSSD 1, OSSD 2) , extraneous light detection, sensor failure, etc. Find and remove the source of error (see page 111).

# Chapter 5

---

# Maintenance



## 5.1 Daily Inspection Checklist

When an error occurs, refer to the chapter on troubleshooting (see page 111) and report this to the maintenance staff in charge. If the problem cannot be solved, please contact our office.

Please make a copy of this checklist, check each inspection item in the respective square, and file the list for your records.



### DANGER!

**Be sure to inspect the following items prior to operation and confirm that there is no error. Operating this device without inspection or in an error condition can result in serious injury or death.**

Check column	Inspection item
□	Dangerous parts of the machine cannot be reached without passing through the sensing area of this device.
□	Some part of the operator's body remains in the sensing area when the operator is working with dangerous parts.
□	The calculated safety distance has been maintained or exceeded during installation.
□	There is no damage to the safety guard or protective structure.
□	There is no defect, fold, or damage in the wiring.
□	The corresponding connectors have been connected securely.
□	There is no dirt or scratches on the light emitting surface.
□	The test rod is not deformed or defective.
□	<p>The operation indicator (green) of the emitter and the OSSD indicator (green) of the receiver light up when there is no object present in the sensing area. The control output (OSSD 1, OSSD 2) is in ON status.</p> <p>At this time, the effect of external noise can be inspected. In case external noise affects the operation, remove its cause and repeat the inspection.</p>
□	<p>The test rod (Ø14mm for SF4B-F□&lt;V2&gt;, Ø25mm for SF4B-H□&lt;V2&gt;, and Ø45mm for SF4B-A□&lt;V2&gt;) can be detected with a maximum speed of 1,600mm/second at three positions, directly in front of the emitter (A), midway between the emitter and the receiver (B), and directly in front of the receiver (C).</p> <p>The OSSD indicator (red) of the receiver and the operation indicator (red) of the emitter continue to light up as long as the test rod is present in the sensing area from (A) to (C).</p>

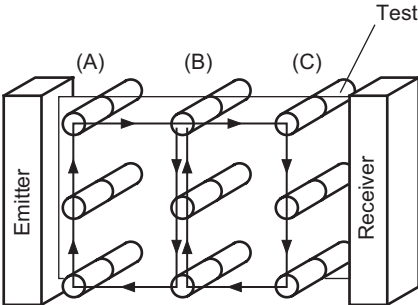
Check column	Inspection item
	
<input type="checkbox"/>	<p>With the machine in operating condition, the dangerous parts operate normally when no object is present in the sensing area.</p>
<input type="checkbox"/>	<p>With the machine in operating condition, the dangerous parts stop immediately when the test rod is inserted into the sensing area at any of the three positions, directly in front of the emitter (A), midway between the emitter and the receiver (B), and directly in front of the receiver (C).</p>
<input type="checkbox"/>	<p>The dangerous parts remain stopped as long as the test rod is present in the sensing area.</p>
<input type="checkbox"/>	<p>The dangerous parts stop immediately when the power supply of this device is turned OFF.</p>
<input type="checkbox"/>	<p>The control output (OSSD 1, OSSD 2) must turn OFF when the emission halt input/reset input line is open (for manual reset: connected to 0V, +V). At this time, the effect of external noise can be inspected. In case external noise affects the operation, remove its cause and repeat the inspection.</p>
<input type="checkbox"/>	<p>Be sure to check the operation of the muting function before using it. Check the state of the muting lamp (cleanliness, brightness, etc.)</p>

## 5.2 Periodic Inspection Checklist (Every Six Months)



### **DANGER!**

**Be sure to inspect the following items every six months and confirm that there is no error. Operating this device without inspection or in an error condition can result in serious injury or death.**

Check column	Inspection item
<input type="checkbox"/>	The structure of the machine does not obstruct any of the safety mechanisms designed for stopping the operation.
<input type="checkbox"/>	No modification has been made in the machine controls which obstructs the safety mechanisms.
<input type="checkbox"/>	The output of this device is detected correctly.
<input type="checkbox"/>	The wiring from this device is correct.
<input type="checkbox"/>	The overall response time of the complete machine is equal to or less than the calculated value.
<input type="checkbox"/>	The actual number of operation cycles (time) of the limited lifetime parts (relay, etc.) is less than their rated operation cycles (time).
<input type="checkbox"/>	No screws or connectors of this device are loose.
<input type="checkbox"/>	No extraneous light source or reflective object has been added near this device.

## 5.3 Inspection after Maintenance

---

In the following situations, inspect all items mentioned in Daily Inspection Checklist (see page 106) and Periodic Inspection Checklist (Every Six Months) (see page 108).

- When any part of this device needs to be replaced.
- When abnormalities occur during operation.
- When you perform beam-axis alignment of the emitter and receiver.
- When the installation place or environment of this device is changed.
- When the wiring method or wiring layout is changed.
- When FSD (Final Switching Device) parts are replaced.
- When FSD (Final Switching Device) settings are changed.

# Chapter 6

---

# Troubleshooting

## 6.1 Emitter-Related Problems

When a problem occurs, please check the following items first:

- Check the wiring.
- Check the power supply voltage and the power supply capacity.
- If the device does not work normally after checking the items listed below, please consult your local dealer.

### 6.1.1 All Indicators Are OFF

Cause	Remedy
No power.	Check that the power supply capacity is sufficient. Connect the power supply correctly.
Supply voltage is outside the specified range.	Set the supply voltage correctly.
Connector is not connected securely.	Connect the connector securely.

### 6.1.2 Fault Indicator (Yellow) Lights up or Blinks

Error	Cause	Remedy
<b>[Digital error indicator: 0 ]</b> Error in the setting data of this device	Series connection is incorrect.	Check that the series connection cable does not short-circuit, or is connected to the correct position (emitter for emitter, receiver for receiver). Disconnect the handy controller SFB-HC.
	Noise is outside the specified range.	Check the noise status around this device. Disconnect the handy controller SFB-HC.
	Internal error	Replace this device.
<b>[Digital error indicator: 1 ]</b> System error	Different types of emitter and receiver have been connected	Only pair up emitters and receivers of the same type, i.e. with the same number of beam channels.
<b>[Digital error indicator: 2 ]</b> Series connection error	The serial signal short-circuits or a wire has broken.	Check if the end cap has been fitted properly. Check that the series connection cable does not short-circuit or is connected to the correct position (emitter with emitter, receiver with receiver).
	There is an error in the other sensor in the series connection.	Check the error status of the sensor connected with the series connection cable.
<b>[Digital error indicator: 3 ]</b> Total system number/total beam channel number error	The total system number/total beam channel number is outside the specified range.	You have connected more than the valid number of systems or beam channels in series (see page 51). You can connect a maximum of 3 systems and/or 192 beam channels.
<b>[Digital error indicator: 4 ]</b> Interlock setting error	Voltage level of interlock setting input wire or emission halt input/reset input wire is unstable.	Wire the interlock setting input wire and emission halt input/reset input wire correctly.

Error	Cause	Remedy
<b>[Digital error indicator: <math>\zeta</math>, <math>\eta</math> ]</b> Muting lamp error	Muting lamp output short-circuits with +V or 0V.	Wire the muting lamp output correctly.  The current value should be within the specified range for muting lamp output.
	Muting lamp output short-circuits with other I/O wires.	
	Excessive current flows at the muting lamp output.	
	Output polarity setting wire (shield) and muting lamp output are not correctly wired.	Wire the output polarity setting wire (shield) correctly. (+V: NPN output, 0V: PNP output) Wire the shield wire of the emitter correctly.
	Output circuit error	Output circuit is damaged. Replace this device.
<b>[Digital error indicator: <math>\tau</math> ]</b> Shield wire error	The shield wire is broken or short-circuits with other I/O wires.  Shield wire connection of emitter/receiver is incorrect.	Wire the output polarity setting wire (shield) correctly. (+V: NPN output, 0V: PNP output) Wire the shield wire of the receiver correctly.
<b>[Digital error indicator: <math>\xi</math> ]</b> Effect from noise/power supply or failure of internal circuit	Affected by noise/power supply.  Internal circuit is broken.	Check the noise status around this device. Check the wiring status, supply voltage, and power supply capacity. If it is not possible to locate and remedy the error, contact your local dealer.

### 6.1.3 Setting Indicator Lights Up // Emitter

The following problems can cause the digital error indicator  $\epsilon$  to light up:

Error	Cause	Remedy
Synchronization wire error	Synchronization wire is short-circuited or disconnected.	Connect the synchronization wire properly.
Receiver error		Check whether the receiver side works properly.

### 6.1.4 Emission Halt Indicator (Orange) Lights Up

Error	Cause	Remedy
Emission is in halt condition (Device error or interlock setting error)	Error indicator (yellow) lights up or blinks.	Check the contents of the digital error indicator.
	Emission halt input/reset input is in open state at the time when auto-reset is	Wire the emission halt input/reset input wire to 0V or +V.

Error	Cause	Remedy
	activated	
	Emission halt input/reset input wire is connected to +V or 0V at the time when manual reset is activated.	Interrupt the contact of the emission halt input/reset input.

### 6.1.5 All Beam-axis Adjustment Indicators (Red) Light Up

Cause	Remedy
The beam channels which have been selected for the fixed blanking function receive light.	Turn ON the power supply after checking the installation status.

### 6.1.6 Operation Indicator Remains Lit in Red

When the operation indicator remains lit in red, it means that no light is received.

Cause	Remedy
The beam channels are not correctly aligned.	Align the top/bottom beam channels (see page 69) of the emitter and the receiver properly.
The sensing range is shortened because of the emission amount control function.	Reset to factory default (CLR) with the handy controller SFB-HC (optional).



## 6.2 Receiver-Related Problems

When a problem occurs, please check the following items first:

- Check the wiring.
- Check the power supply voltage and the power supply capacity.
- If the device does not work normally after checking the items listed below, please consult your local dealer.

### 6.2.1 All Indicators Are OFF

Cause	Remedy
No power.	Check that the power supply capacity is sufficient. Connect the power supply correctly.
Supply voltage is outside the specified range.	Set the supply voltage correctly.
Connector is not connected securely.	Connect the connector securely.

### 6.2.2 Fault Indicator (Yellow) Lights up or Blinks

Error	Cause	Remedy
<b>[Digital error indicator: 0 ]</b> Error in the setting data of this device	Series connection is incorrect.	Check that the series connection cable does not short-circuit, or is connected to the correct position (emitter for emitter, receiver for receiver). Disconnect the handy controller SFB-HC.
	Noise is outside the specified range.	Check the noise status around this device. Disconnect the handy controller SFB-HC.
	Internal error	Replace this device.
<b>[Digital error indicator: 1 ]</b> System error	Different types of emitter and receiver have been connected	Only pair up emitters and receivers of the same type, i.e. with the same number of beam channels.
<b>[Digital error indicator: 2 ]</b> Series connection error	The serial signal short-circuits or a wire has broken.	Check if the end cap has been fitted properly. Check that the series connection cable does not short-circuit, or is connected to the correct position (emitter with emitter, receiver with receiver).
	There is an error in the other sensor in the series connection.	Check the error status of the sensor connected with the series connection cable.
<b>[Digital error indicator: 3 ]</b> Total system number/total beam channel number error	The total system number/total beam channel number is outside the specified range.	You have connected more than the valid number of systems or beam channels in series (see page 51). You can connect a maximum of 3 systems and/or 192 beam channels.

Error	Cause		Remedy
<p><b>[Digital error indicator: 4 ]</b> Extraneous light error</p>	<p>Extraneous light or light from other model is entering.</p>		<p>When the power is ON, prevent any extraneous light from entering the receiver.</p> <p>If the extraneous light is coming from this device, check the sensor placement (see page 25) or use the interference prevention function (see page 77).</p>
<p><b>[Digital error indicator: 5, 9 ]</b> Control output (OSSD 1, OSSD 2) error</p>	<p>OSSD 1/2 wire short-circuits with +V or 0V.</p>		<p>Wire the control output (OSSD 1/2) correctly (see page 44).</p> <p>Current value should be within the specified range of the control output (OSSD 1/2) wires (see page 124).</p>
	<p>Control output (OSSD 1/2) wires short-circuit respectively, or short-circuit with other I/O wires.</p>		
	<p>Excessive incoming current flows in the control output (OSSD 1/2) wires.</p>		
	<p>Output polarity setting wire (shield) and control output (OSSD 1/2) wires are not correctly wired.</p>		<p>Wire the output polarity setting wire (shield) correctly. (+V: NPN output, 0V: PNP output)</p> <p>Wire the shield wire of the emitter correctly.</p>
	<p>Output circuit error</p>		<p>Output circuit is damaged. Replace this device.</p>
<p><b>[Digital error indicator: 7 ]</b> Shield wire error</p>	<p>The shield wire is broken or short-circuits with other I/O wires.</p> <p>Shield wire connection of emitter/receiver is incorrect.</p>		<p>Wire the output polarity setting wire (shield) correctly. (+V: NPN output, 0V: PNP output)</p> <p>Wire the shield wire of the receiver correctly.</p>
<p><b>[Digital error indicator : 7 ]</b> External device error</p>	<p>When using safety relay</p>	<p>Relay contact is welded.</p>	<p>Replace the relay.</p>
		<p>Response time of the relay is slow.</p>	<p>Replace with a relay with the proper response time (see page 79).</p> <p>Setting the response time with the handy controller SFB-HC (optional) is possible.</p>
		<p>Contacting point 'b' of the relay is not wired.</p>	<p>Wire the relay correctly.</p>
	<p>When deactivating the external device monitor function</p>	<p>Auxiliary output wire and external device monitor input wire are not connected.</p>	<p>Connect the auxiliary output wire and the external device monitor input wire.</p> <p>Deactivate the external device monitor function with the handy controller SFB-HC (optional).</p>
		<p>Auxiliary output is not correctly operated.</p>	<p>Check if the auxiliary output wire is disconnected or short-circuited.</p> <p>Reset to factory default (mode 0) with the handy controller SFB-HC (optional).</p>

Error	Cause	Remedy
	The bottom cap cables for emitter and receiver have been mixed up.	Check the connecting locations of the bottom cap cables.
<b>[Digital error indicator: <math>\bar{F}</math> ]</b> Effect from noise/power supply or failure of internal circuit	Affected by noise/power supply. Internal circuit is broken.	Check the noise status around this device. Check the wiring status, supply voltage, and power supply capacity. If it is not possible to locate and remedy the error, contact your local dealer.

### 6.2.3 Digital Error Indicator "C" Lights Up

The following problems can cause the digital error indicator  $\bar{c}$  to light up:

Error	Cause	Remedy
Synchronization wire error	Synchronization wire is short-circuited or disconnected.	Connect the synchronization wire properly.
Emitter error		Check whether the emitter side works properly.

### 6.2.4 All Beam-axis Adjustment Indicators (Red) Light Up

Cause	Remedy
The beam channels which have been selected for the fixed blanking function receive light.	Turn ON the power supply after checking the installation status.

### 6.2.5 Operation Indicator Remains Lit in Red

When the operation indicator remains lit in red, it means that no light is received.

Cause	Remedy
The beam channels are not correctly aligned.	Align the top/bottom beam channels (see page 69) of the emitter and the receiver properly.

# Chapter 7

---

## Specifications

## 7.1 Specifications by Model Numbers

The model nos. contain information about the beam pitch and the number of channels:

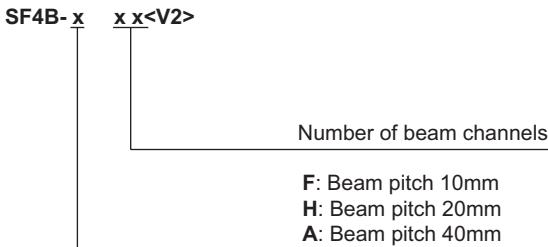

### ◆ EXAMPLE

The model no. SF4B-F55 represents the beam pitch type of 10mm and 55 beam channels.

The specifications listed hereafter are sorted by beam pitch type and number of beam channels in ascending order.

### 7.1.1 Model Numbers SF4B-Fxx<V2> with 10mm Beam Pitch

	SF4B-F23 <V2>	SF4B-F31 <V2>	SF4B-F39 <V2>	SF4B-F47 <V2>	SF4B-F55 <V2>	SF4B-F63 <V2>
No. of beam channels	23	31	39	47	55	63
Sensing range	0.3 to 7m					
Beam pitch	10mm					
Sensing height	230mm	310mm	390mm	470mm	550mm	630mm
Current consumption	Emitter: 80mA or less Receiver: 120mA or less			Emitter: 100mA or less Receiver: 160mA or less		
PFHd*	2.56 x 10 <sup>-9</sup>	2.96 x 10 <sup>-9</sup>	3.36 x 10 <sup>-9</sup>	3.75 x 10 <sup>-9</sup>	4.15 x 10 <sup>-9</sup>	4.55 x 10 <sup>-9</sup>
MTTFd*	More than 100 years					
Weight (emitter and receiver together)	570g approx.	680g approx.	800g approx.	920g approx.	1,030g approx.	1,150g approx.

	SF4B-F71 <V2>	SF4B-F79 <V2>	SF4B-F95 <V2>	SF4B-F111 <V2>	SF4B-F127 <V2>
No. of beam channels	71	79	95	111	127
Sensing range	0.3 to 7m				

	SF4B-F71 <V2>	SF4B-F79 <V2>	SF4B-F95 <V2>	SF4B-F111 <V2>	SF4B-F127 <V2>
<b>Beam pitch</b>	10mm				
<b>Sensing height</b>	710mm	790mm	950mm	1,110mm	1,270mm
<b>Current consumption</b>	Emitter: 100mA or less  Receiver: 160mA or less	Emitter: 115mA or less Receiver: 190mA or less		Emitter: 135mA or less Receiver: 230mA or less	
<b>PFHd</b>	$4.95 \times 10^{-9}$	$5.35 \times 10^{-9}$	$6.15 \times 10^{-9}$	$6.94 \times 10^{-9}$	$7.74 \times 10^{-9}$
<b>MTTFd</b>	More than 100 years				
<b>Weight (emitter and receiver together)</b>	1,260g approx.	1,380g approx.	1,620g approx.	1,850g approx.	2,090g approx.

\* PFHd: Probability of dangerous failure per hour, MTTFd: Mean time to dangerous failure

### 7.1.2 Model Numbers SF4B-Hxx<V2> with 20mm Beam Pitch

	SF4B-H12 <V2>	SF4B-H16 <V2>	SF4B-H20 <V2>	SF4B-H24 <V2>	SF4B-H28 <V2>	SF4B-H32 <V2>
<b>No. of beam channels</b>	12	16	20	24	28	32
<b>Sensing range</b>	0.3 to 9m					
<b>Beam pitch</b>	20mm					
<b>Sensing height</b>	230mm	310mm	390mm	470mm	550mm	630mm
<b>Current consumption</b>	Emitter: 70mA or less Receiver: 95mA or less			Emitter: 80mA or less Receiver: 115mA or less		
<b>PFHd*</b>	$2.01 \times 10^{-9}$	$2.21 \times 10^{-9}$	$2.41 \times 10^{-9}$	$2.61 \times 10^{-9}$	$2.81 \times 10^{-9}$	$3.01 \times 10^{-9}$
<b>MTTFd*</b>	More than 100 years					
<b>Weight (emitter and receiver together)</b>	570g approx.	680g approx.	800g approx.	920g approx.	1,030g approx.	1,150g approx.

	SF4B-H36 <V2>	SF4B-H40 <V2>	SF4B-H48 <V2>	SF4B-H56 <V2>	SF4B-H64 <V2>	SF4B-H72 <V2>
<b>No. of beam channels</b>	36	40	48	56	64	72
<b>Sensing range</b>	0.3 to 9m					0.3 to 7m
<b>Beam pitch</b>	20mm					
<b>Sensing height</b>	710mm	790mm	950mm	1,110mm	1,270mm	1,430mm
<b>Current consump</b>	Emitter: 80mA or	Emitter: 90mA or less		Emitter: 100mA or less, Receiver: 160mA or less		Emitter: 110mA or

	SF4B-H36 <V2>	SF4B-H40 <V2>	SF4B-H48 <V2>	SF4B-H56 <V2>	SF4B-H64 <V2>	SF4B-H72 <V2>
<b>tion</b>	less Receiver: 115mA or less	Receiver: 140mA or less				less Receiver: 180mA or less
<b>PFHd*</b>	$3.21 \times 10^{-9}$	$3.41 \times 10^{-9}$	$3.80 \times 10^{-9}$	$4.20 \times 10^{-9}$	$4.60 \times 10^{-9}$	$5.00 \times 10^{-9}$
<b>MTTFd*</b>	More than 100 years					
<b>Weight (emitter and receiver together)</b>	1,260g approx.	1,380g approx.	1,620g approx.	1,850g approx.	2,090g approx.	2,320g approx.

	SF4B-H80<V2>	SF4B-H88<V2>	SF4B-H96<V2>
<b>No. of beam channels</b>	80	88	96
<b>Sensing range</b>	0.3 to 7m		
<b>Beam pitch</b>	20mm		
<b>Sensing height</b>	1,590mm	1,750mm	1,910mm
<b>Current consumption</b>	Emitter: 110mA or less Receiver: 180mA or less	Emitter: 120mA or less Receiver: 200mA or less	
<b>PFHd*</b>	$5.40 \times 10^{-9}$	$5.80 \times 10^{-9}$	$6.20 \times 10^{-9}$
<b>MTTFd*</b>	More than 100 years		
<b>Weight (emitter and receiver together)</b>	2,540g approx.	2,780g approx.	3,010g approx.

\* PFHd: Probability of dangerous failure per hour, MTTFd: Mean time to dangerous failure

### 7.1.3 Model Numbers SF4B-Axx<V2> with 40mm Beam Pitch

	SF4B-A6 <V2>	SF4B-A8 <V2>	SF4B-A10 <V2>	SF4B-A12 <V2>	SF4B-A14 <V2>	SF4B-A16 <V2>
<b>No. of beam channels</b>	6	8	10	12	14	16
<b>Sensing range</b>	0.3 to 9m					
<b>Beam pitch</b>	40mm					
<b>Sensing height</b>	230mm	310mm	390mm	470mm	550mm	630mm
<b>Current consumption</b>	Emitter: 65mA or less Receiver: 85mA or less			Emitter: 70mA or less Receiver: 95mA or less		
<b>PFHd*</b>	$1.71 \times 10^{-9}$	$1.81 \times 10^{-9}$	$1.91 \times 10^{-9}$	$2.01 \times 10^{-9}$	$2.11 \times 10^{-9}$	$2.21 \times 10^{-9}$
<b>MTTFd*</b>	More than 100 years					
<b>Weight (emitter and receiver together)</b>	570g approx.	680g approx.	800g approx.	920g approx.	1,030g approx.	1,150g approx.

	SF4B-A18 <V2>	SF4B-A20 <V2>	SF4B-A24 <V2>	SF4B-A28 <V2>	SF4B-A32 <V2>	SF4B-A36 <V2>
<b>No. of beam channels</b>	18	20	24	28	32	36
<b>Sensing range</b>	0.3 to 9m					0.3 to 7m
<b>Beam pitch</b>	40mm					
<b>Sensing height</b>	710mm	790mm	950mm	1,110mm	1,270mm	1,430mm
<b>Current consumption</b>	Emitter: 70mA or less  Receiver: 95mA or less	Emitter: 75mA or less Receiver: 105mA or less		Emitter: 80mA or less Receiver: 120mA or less		Emitter: 85mA or less  Receiver: 130mA or less
<b>PFHd*</b>	$2.31 \times 10^{-9}$	$2.41 \times 10^{-9}$	$2.61 \times 10^{-9}$	$2.81 \times 10^{-9}$	$3.01 \times 10^{-9}$	$3.21 \times 10^{-9}$
<b>MTTFd*</b>	More than 100 years					
<b>Weight (emitter and receiver together)</b>	1,260g approx.	1,380g approx.	1,620g approx.	1,850g approx.	2,090g approx.	2,320g approx.

	SF4B-A40<V2>	SF4B-A44<V2>	SF4B-A48<V2>
<b>No. of beam channels</b>	40	44	48
<b>Sensing range</b>	0.3 to 7m		
<b>Beam pitch</b>	40mm		
<b>Sensing height</b>	1,590mm	1,750mm	1,910mm
<b>Current consumption</b>	Emitter: 85mA or less Receiver: 130mA or less	Emitter: 95mA or less Receiver: 140mA or less	
<b>PFHd*</b>	$3.41 \times 10^{-9}$	$3.61 \times 10^{-9}$	$3.80 \times 10^{-9}$
<b>MTTFd*</b>	More than 100 years		
<b>Weight (emitter and receiver together)</b>	2,540g approx.	2,780g approx.	3,010g approx.

\* PFHd: Probability of dangerous failure per hour, MTTFd: Mean time to dangerous failure



## 7.2 Common Specifications

Item	10mm pitch type SF4B-F<V2>	20mm pitch type SF4B-H<V2>	40mm pitch type SF4B-AF<V2>
<b>Detecting capability</b> (Min. object to be sensed)	Ø14mm opaque object	Ø25mm opaque object	Ø45mm opaque object
<b>Effective aperture angle (EAA)</b>	±2.5° or less for sensing range exceeding 3m (required by IEC 61496-2/UL 61496-2)		
<b>Supply voltage</b>	24V DC ±10%. Ripple P-P 10% or less		
<b>Control output</b> (OSSD 1, OSSD 2)	<p>PNP open-collector transistor/NPN open-collector transistor (switching type)</p> <ul style="list-style-type: none"> <li>For PNP output: Max. source current 200mA</li> <li>For NPN output: Max. sink current 200mA</li> </ul> <p>Applied voltage: same as supply voltage (for PNP output: between the control output (OSSD 1/2) and +V, for NPN output between the control output (OSSD 1/2) and 0V)</p> <ul style="list-style-type: none"> <li>Residual voltage: 2.5V or less (For PNP output: source current 200mA, for NPN output: sink current 200mA) (when using 20m length cable)</li> <li>Switching behaviour (output operation): ON when all beams are received, OFF when one or more beams are blocked (Note 1) (Note 2) (OFF when fault occurs in the sensor or the synchronization signal error, too)</li> </ul> <p>Protection circuit (short circuit): Incorporated</p>		
<b>Response time</b>	In normal operation: ON → OFF: 14ms or less, OFF → ON: 80 to 90ms or less		
<b>Auxiliary output</b> (Non-safety output)	<p>PNP open-collector transistor/NPN open-collector transistor (switching type)</p> <ul style="list-style-type: none"> <li>For PNP output: Max. source current 60mA</li> <li>For NPN output: Max. sink current 60mA</li> </ul> <p>Applied voltage: same as supply voltage (for PNP output: between the auxiliary output and +V, for NPN output between the auxiliary output and 0V)</p> <ul style="list-style-type: none"> <li>Residual voltage: 2.5V or less (In case of selecting PNP output: source current 60mA, in case of selecting NPN output: sink current 60mA) (when using 20m length cable)</li> <li>Switching behaviour (output operation): When OSSDs are ON: OFF, when OSSDs are OFF: ON (factory setting). Can be changed with the optionally available handy controller SFB-HC</li> </ul> <ul style="list-style-type: none"> <li>Protection circuit (short circuit): Incorporated</li> </ul>		
<b>Degree of protection</b>	IP65 and IP67 (IEC)		
<b>Ambient temperature</b>	-10 to +55°C (No dew condensation or icing allowed), storage: -25 to +70°C		
<b>Ambient humidity</b>	30 to 85% RH, storage: 30 to 95% RH		
<b>Allowed ambient light</b>	Incandescent lamp: 3,500lx at the light-receiving surface		

Item	10mm pitch type SF4B-F<V2>	20mm pitch type SF4B-H<V2>	40mm pitch type SF4B-AF<V2>
<b>Withstand voltage</b>	1,000V AC for one min. (between all supply terminals connected together and enclosure)		
<b>Insulation resistance</b>	20MΩ or more with 500V DC (between all supply terminals connected together and enclosure)		
<b>Vibration resistance</b>	10 to 55Hz frequency, 0.75mm amplitude in X, Y, and Z directions for two hours each		
<b>Shock resistance</b>	300m/s <sup>2</sup> acceleration (30G approx.) in X, Y, and Z directions for three times each		
<b>Emitting element</b>	Infrared LED (Peak emission wavelength: 870nm)		
<b>Connection method</b>	Connection with connectors		
<b>Cable extension</b>	Extension up to total 50m is possible for both emitter and receiver connecting cable (optional)(note 3)		
<b>Material</b>	Enclosure: Aluminum, Upper/lower case: Zinc, Sensing surface: Polycarbonate, Cap: PBT		
<b>Accessory</b>	MS-SFB-2 (intermediate supporting bracket, note 4) SF4B-TR14 (test rod): 1 pc.	MS-SFB-2 (intermediate supporting bracket, note 4) SF4B-TR25 (test rod): 1 pc.	MS-SFB-2 (intermediate supporting bracket, note 4)
<b>Applicable standard</b>	JIS B 9704-1/2 (Type 4), JIS B 9705-1 (ISO 13849-1) (Category 4), JIS C 0508 (SIL), EN 954-1 (Category 4), EN 55011, EN 61496-1 (Type 4), IEC 61496-1/2 (Type 4), IEC 61508-1 to 7 (SIL3), UL 61496-1/2 (Type 4), UL 1998 (Class 2)		



◆ **NOTE**

- The beam channel is not turned OFF during muting even if it is blocked.**
- When the blanking function is activated, the switching behaviour is changed.**
- The cable can be extended up to 30m (for emitter/receiver) when two safety light curtains are connected in series, up to 20m when three safety light curtains are connected series. When the muting lamp is used, the cable can be extended up to 40m (for emitter/receiver).**
- The intermediate support bracket MS-SFB-2 is enclosed with the following safety light curtains. The number of enclosed brackets differs depending on the safety light curtain as follows:**

Number of systems	Safety light curtains model	Number of beam channels
1	SF4B-F□	79 to 111
	SF4B-H□	40 to 56
	SF4B-A□	20 to 28
2	SF4B-F127, SF4B-H□	64 to 80
	SF4B-A□	32 to 40

Number of systems	Safety light curtains model	Number of beam channels
3	SF4B-H□	88 to 96
	SF4B-A□	44 to 48



### **DANGER!**

The functions of this device can be set with the optional handy controller SFB-HC. Please note that the safety distance, the size of the minimum object to be sensed, the response speed, etc. may differ depending on the function. When you set each function, recalculate the safety distance and install the device at a distance larger than the safety distance. Not keeping the distance may result in a situation where the machine does not stop quickly enough, resulting in serious bodily injury or death.



### **◆ NOTE**

- You can use the handy controller SFB-HC (optional) to set the functions (see page 88).
- Both emitter and receiver are adjusted before shipment; please use the emitter and receiver with the same serial number together. The serial number is indicated on the plates of both emitter and receiver. The last five digits under the model is the serial number.

## 7.3 Options

The following options are available:

- Front protection cover (see page 127)
- Different types of cables (see page 128)
- Different types of brackets (see page 130)
- Handy controller (see page 134)
- Laser alignment tool (see page 134)
- Different types of control units (see page 135)
- Protect bar (see page 137)

### 7.3.1 Front Protection Cover

Front protection cover: 1 pc.

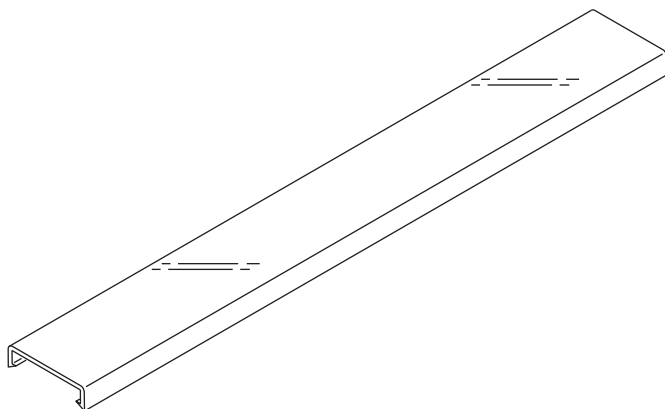

*Front protection cover*

Model No.	Applicable for			Remarks
FC-SFBH-12	SF4B-F23<V2>	SF4B-H12<V2>	SF4B-A6<V2>	Protects the sensing surface of the sensor from dirt, etc.
FC-SFBH-16	SF4B-F31<V2>	SF4B-H16<V2>	SF4B-A8<V2>	
FC-SFBH-20	SF4B-F39<V2>	SF4B-H20<V2>	SF4B-A10<V2>	
FC-SFBH-24	SF4B-F47<V2>	SF4B-H24<V2>	SF4B-A12<V2>	
FC-SFBH-28	SF4B-F55<V2>	SF4B-H28<V2>	SF4B-A14<V2>	
FC-SFBH-32	SF4B-F63<V2>	SF4B-H32<V2>	SF4B-A16<V2>	
FC-SFBH-36	SF4B-F71<V2>	SF4B-H36<V2>	SF4B-A18<V2>	
FC-SFBH-40	SF4B-F79<V2>	SF4B-H40<V2>	SF4B-A20<V2>	
FC-SFBH-48	SF4B-F95<V2>	SF4B-H48<V2>	SF4B-A24<V2>	

Model No.	Applicable for			Remarks
FC-SFBH-56	SF4B-F111<V2>	SF4B-H56<V2>	SF4B-A28<V2>	
FC-SFBH-64	SF4B-F127<V2>	SF4B-H64<V2>	SF4B-A32<V2>	
FC-SFBH-72		SF4B-H72<V2>	SF4B-A36<V2>	
FC-SFBH-80		SF4B-H80<V2>	SF4B-A40<V2>	
FC-SFBH-88		SF4B-H88<V2>	SF4B-A44<V2>	
FC-SFBH-96		SF4B-H96<V2>	SF4B-A48<V2>	



**NOTE**

Please note that the sensing distance is shortened when the front protection cover is attached.

### 7.3.2 Cables

Various cables are available.

#### 7.3.2.1 Bottom Cap Cables

You receive 2 pieces/set, one for the emitter (gray connector) and one for the receiver (black connector).

Discrete wire

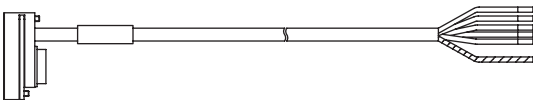

Connector

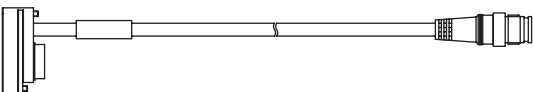

Type	Model No.	Cable length	Remarks
8-core discrete wire	SFB-CCB3	3m	For normal operation. For emitter: Gray connector, 8-core shielded cable For receiver: Black connector, 8-core shielded cable
	SFB-CCB7	7m	
	SFB-CCB10	10m	
	SFB-CCB15	15m	
8-core connector	SFB-CB05	0.5m	
	SFB-CB5	5m	
	SFB-CB10	10m	
12-core discrete wire	SFB-CCB3-MU	3m	The 12-core bottom cap cable is used when the muting function is activated.
	SFB-CCB7-MU	7m	

Type	Model No.	Cable length	Remarks
12-core connector	SFB-CB05-MU	0.5m	For emitter: Gray connector, 12-core shielded cable For receiver: Black connector, 12-core shielded cable

### 7.3.2.2 Extension Cable with Connector on One End

You receive 2 pieces/set, one for the emitter (gray connector) and one for the receiver (black connector).

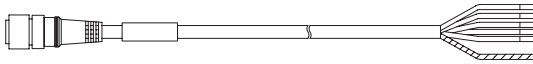

Type	Model No.	Cable length	Remarks
8-core discrete wire	SFB-CC3	3m	For extending the normal cable. <ul style="list-style-type: none"> <li>For emitter: Gray connector, 8-core shielded cable</li> <li>For receiver: Black connector, 8-core shielded cable</li> </ul>
	SFB-CC10	10m	
12-core discrete wire	SFB-CC3-MU	3m	For extending the cable. <ul style="list-style-type: none"> <li>For emitter: Gray connector, 12-core shielded cable</li> <li>For receiver: Black connector, 12-core shielded cable</li> </ul>
	SFB-CC10-MU	10m	

### 7.3.2.3 Extension Cable with Connectors on Both Ends

You receive 1 piece. The emitter cable has gray connectors, the receiver cable has black connectors.



Type	Model No.	Cable length	Remarks
8-core cable for emitter	SFB-CCJ10E	10m	For extending the normal cable. <ul style="list-style-type: none"> <li>For emitter: Gray connector, 8-core shielded cable</li> <li>For receiver: Black connector, 8-core shielded cable</li> </ul>
8-core cable for receiver	SFB-CCJ10D		
12-core cable for emitter	SFB-CCJ10E-MU		When the muting function is activated, this cable is used for extending the cable. <ul style="list-style-type: none"> <li>For emitter: Gray connector, 12-core shielded cable</li> <li>For receiver: Black connector, 12-core shielded cable</li> </ul>
12-core cable for receiver	SFB-CCJ10D-MU		

### 7.3.2.4 Cable for Series Connection

You receive 2 pieces/set for both the emitter and the receiver.

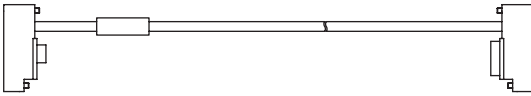

Model No.	Cable length	Remarks
SFB-CSL01	0.1m	Used to connect sensors in series. This cable is used for both the emitter and the receiver.
SFB-CSL05	0.5m	
SFB-CSL1	1m	
SFB-CSL5	5m	

### 7.3.2.5 Cable for Application Expansion Unit SF-C14EX

You receive 2 pieces/set, one for the emitter (gray connector) and one for the receiver (black connector).

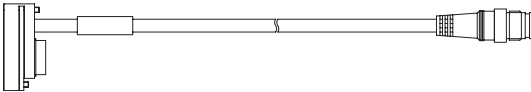

Model No.	Cable length	Remarks
SFB-CB05-EX	0.5m	Used for connecting the sensor to the application expansion unit SF-C14EX (optional). <ul style="list-style-type: none"> <li>For emitter: Gray connector, 8-core shielded cable</li> <li>For receiver: Black connector, 8-core shielded cable</li> </ul>
SFB-CB5-EX	5m	
SFB-CB10-EX	1m	

### 7.3.2.6 Cables for PNP/NPN Output

You receive 2 pieces/set.

Connector

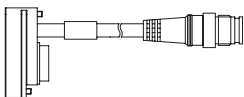

Type	Model No.	Cable length	Remarks
Connector	SFB-CB05-A-P	0.5m	For PNP output of the SF4-AH series.
	SFB-CB05-A-N		For NPN output of the SF4-AH series.
	SFB-CB05-B-P		For PNP output of the SF2-EH series.
	SFB-CB05B-N		For NPN output of the SF2-EH series.

### 7.3.3 Brackets

The following brackets are available.

### 7.3.3.1 Standard Mounting Bracket (M5)

---

You receive 4 pieces/set.

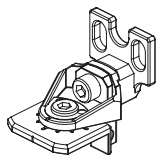

Model No.	Remarks
MS-SFB-1	Enables easy beam alignment. Fix with two hexagon-socket head bolts [M5].

### 7.3.3.2 360° Rotatable Mounting Bracket (M8)

---

You receive 4 pieces/set.

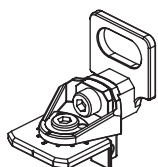

Model No.	Remarks
MS-SFB-1-T	Enables easy beam alignment. Fix with one hexagon-socket head bolt [M8].

### 7.3.3.3 M8 Rear Mounting Bracket

---

You receive 4 pieces/set.

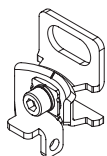

Model No.	Remarks
MS-SFB-7-T	This mounting bracket allows the sensor to be mounted at the rear. Fix with one hexagon-socket head bolt [M8].

### 7.3.3.4 M8 Side Mounting Bracket

---

You receive 4 pieces/set (left-side type 2 pieces, right-side type 2 pieces).

**Left-side type**

**Right-side type**



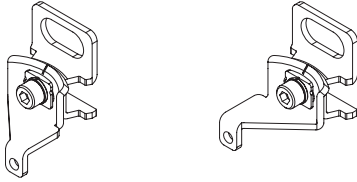

Model No.	Remarks
MS-SFB-7-T	This mounting bracket set allows the sensor to be mounted at the side. Fix each bracket with one hexagon-socket head bolt [M8].

### 7.3.3.5 M8 Rear / Side Mounting Bracket Set

You receive 4 pieces for rear mounting and 4 pieces for side mounting (left-side type 2 pieces, right-side type 2 pieces).

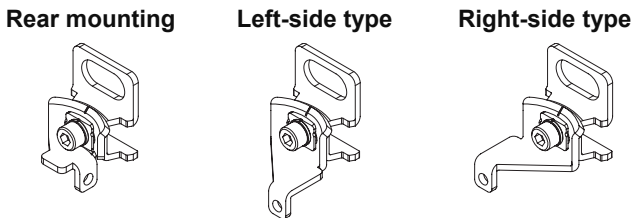

Model No.	Remarks
MS-SFB-1-T2	This mounting bracket allows the sensor to be mounted at the rear or at the side. Fix each bracket with one hexagon-socket head bolt [M8].

### 7.3.3.6 M5 Pitch Adapter Bracket

You receive 4 pieces/set.

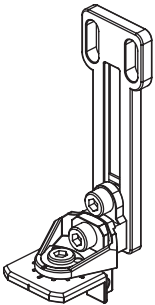

Model No.	Remarks
MS-SFB-4	For replacing other light curtains (sensing height 200mm or more) with the SF4B<V2> series. Fix with two hexagon-socket head bolts [M5].

### 7.3.3.7 M8 Pitch Adapter Bracket

---

You receive 4 pieces/set.

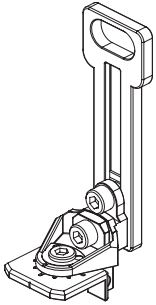

Model No.	Remarks
MS-SFB-4-T	For replacing other light curtains (sensing height 200mm or more) with the SF4B<V2> series. Fix with one hexagon-socket head bolt [M8].

### 7.3.3.8 Dead Zoneless Mounting Bracket

---

You receive 4 pieces/set.

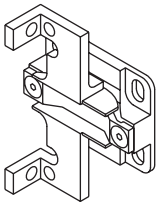

Model No.	Remarks
MS-SFB-3	Reduces dead space.

### 7.3.4 Handy Controller

You receive 1 piece.



Model No.	Remarks
SFB-HC	Handy controller for setting each function.

### 7.3.5 Laser Alignment Tool for Light Curtain

You receive 1 piece.

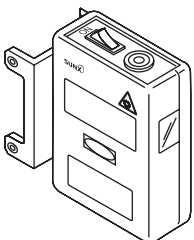

Model No.	Remarks
SF-LAT-2N	Convenient for aligning the beam channels.

### 7.3.6 Control Units

The following control units are available.

#### 7.3.6.1 Unit with Connectors

You receive 1 piece.

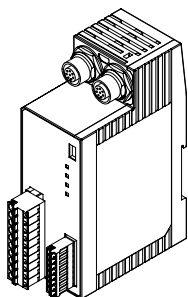

Model No.	Remarks
SF-C11	Conforms to European/North American safety standards. Applicable for 8-core cables with connector.

#### 7.3.6.2 Unit for Demanding Industrial Environments

You receive 1 piece.

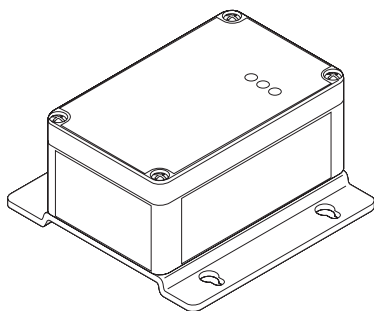

Model No.	Remarks
SF-C12	Conforms to European/North American safety standards (IP65). Applicable for 12-core cable with connector.

### 7.3.6.3 Miniature Unit

You receive 1 piece.

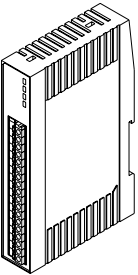

Model No.	Remarks
SF-C13	Conforms to European/North American safety standards.

### 7.3.6.4 Application Expansion Unit

You receive 1 piece.

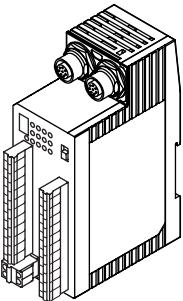

Model No.	Remarks
SF-C14EX	Conforms to European/North American safety standards. It offers the muting function and the emergency stop input, which expand the applications of the light curtain.
SF-C14EX01(Note)	



#### ◆ NOTE

**SF-C14EX01 cannot be used in combination with the optional handy controller SFB-HC.**

### 7.3.7 Protect Bar

You receive 1 set.

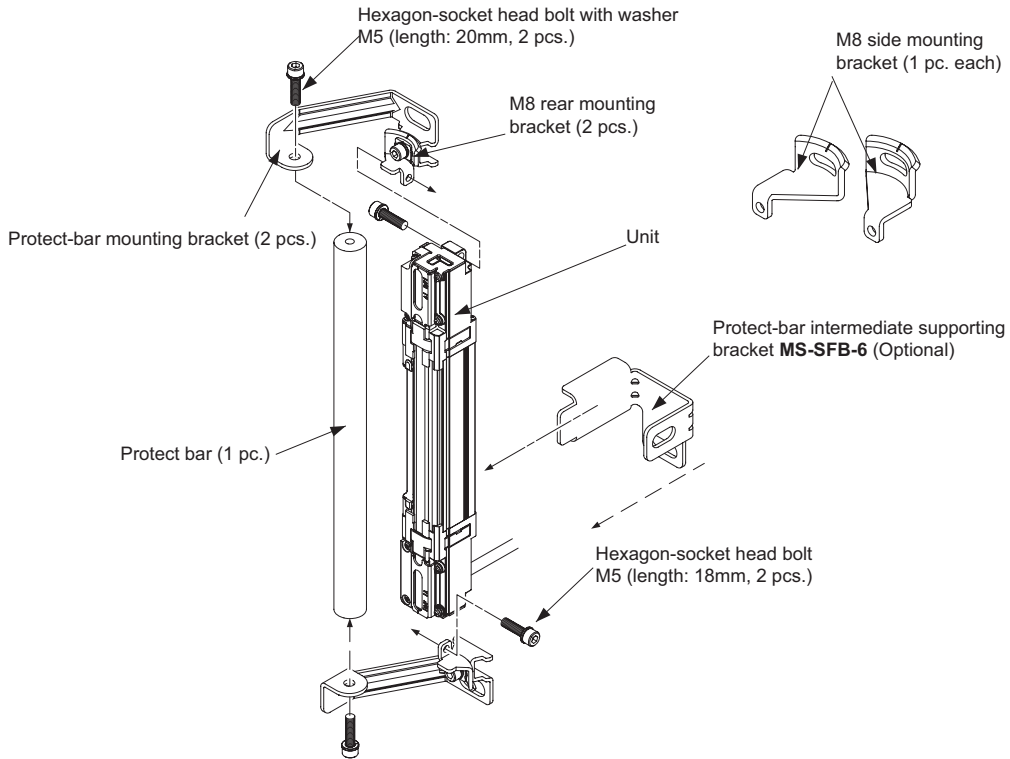

Model No.	Applicable for			Remarks
MC-SFBH-12	SF4B-F23<V2>	SF4B-H12<V2>	SF4B-A6<V2>	Protects the lens surface of the light curtain from being hit and damaged by work pieces.
MC-SFBH-16	SF4B-F31<V2>	SF4B-H16<V2>	SF4B-A8<V2>	
MC-SFBH-20	SF4B-F39<V2>	SF4B-H20<V2>	SF4B-A10<V2>	
MC-SFBH-24	SF4B-F47<V2>	SF4B-H24<V2>	SF4B-A12<V2>	
MC-SFBH-28	SF4B-F55<V2>	SF4B-H28<V2>	SF4B-A14<V2>	
MC-SFBH-32	SF4B-F63<V2>	SF4B-H32<V2>	SF4B-A16<V2>	
MC-SFBH-36	SF4B-F71<V2>	SF4B-H36<V2>	SF4B-A18<V2>	
MC-SFBH-40	SF4B-F79<V2>	SF4B-H40<V2>	SF4B-A20<V2>	
MC-SFBH-48	SF4B-F95<V2>	SF4B-H48<V2>	SF4B-A24<V2>	
MC-SFBH-56	SF4B-F111<V2>	SF4B-H56<V2>	SF4B-A28<V2>	
MC-SFBH-64	SF4B-F127<V2>	SF4B-H64<V2>	SF4B-A32<V2>	
MC-SFBH-72		SF4B-H72<V2>	SF4B-A36<V2>	
MC-SFBH-80		SF4B-H80<V2>	SF4B-A40<V2>	
MC-SFBH-88		SF4B-H88<V2>	SF4B-A44<V2>	
MC-SFBH-96		SF4B-H96<V2>	SF4B-A48<V2>	



### ◆ NOTE

Whether you need the supporting bracket for the protect bar or not depends on the length of the protect bar. We recommend using the supporting bracket for model no. MC-SF4B-48 and higher. As a rule, use the bracket when the protect bar bends a lot.

## 7.3.8 Test Rod

You receive 1 piece.

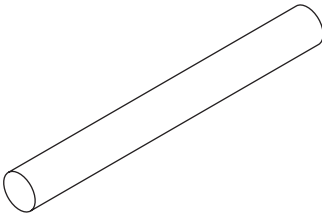

Model No.	Remarks
SFB-TR24	For SF4B-F<V2>, 1 beam channel floating, Ø 24mm
SFB-TR34	For SF4B-F<V2>, 2 beam channels floating, Ø 34mm
SFB-TR45	For SF4B-H<V2>, 1 beam channel floating, Ø 45mm For SF4B-A<V2>, Ø 45mm

# Chapter 8

---

## Dimensions





Model No.	A	B	C	D	E	F
SF4B-A12<V2>						
SF4B-F55<V2>, SF4B-H28<V2>, SF4B-A14<V2>	550	599	616	-	-	-
SF4B-F63<V2>, SF4B-H32<V2>, SF4B-A16<V2>	630	679	696	-	-	-
SF4B-F71<V2>, SF4B-H36<V2>, SF4B-A18<V2>	710	759	776	-	-	-
SF4B-F79<V2>, SF4B-H40<V2>, SF4B-A20<V2>	790	839	856	395	-	-
SF4B-F95<V2>, SF4B-H48<V2>, SF4B-A24<V2>	950	999	1,016	475	-	-
SF4B-F111<V2>, SF4B-H56<V2>, SF4B-A28<V2>	1,110	1,159	1,176	555	-	-
SF4B-F127<V2>, SF4B-H64<V2>, SF4B-A32<V2>	1,270	1,319	1,336	423	847	-
SF4B-H72<V2>, SF4B-A36<V2>	1,430	1,479	1,496	477	953	-
SF4B-H80<V2>, SF4B-A40<V2>	1,590	1,639	1,656	530	<b>1,060</b>	-
SF4B-H88<V2>, SF4B-A44<V2>	1,750	1,799	1,816	438	875	<b>1,313</b>
SF4B-H96<V2>, SF4B-A48<V2>	1,910	1,959	1,946	478	955	1,433

Type	G	H
SF4B-F□<V2>	10	5
SF4B-H□<V2>	20	5
SF4B-A□<V2>	40	15



#### ◆ NOTE

The intermediate supporting bracket (MS-SFB-2) is enclosed with the sensors.  
The number of the brackets varies depending on the sensor.



Model No.	A	B	C	D	E	F
SF4B-F71<V2>, SF4B-H36<V2>, SF4B-A18<V2>	710	759	776	-	-	-
SF4B-F79<V2>, SF4B-H40<V2>, SF4B-A20<V2>	790	839	856	395	-	-
SF4B-F95<V2>, SF4B-H48<V2>, SF4B-A24<V2>	950	999	1,016	475	-	-
SF4B-F111<V2>, SF4B-H56<V2>, SF4B-A28<V2>	1,110	1,159	1,176	555	-	-
SF4B-F127<V2>, SF4B-H64<V2>, SF4B-A32<V2>	1,270	1,319	1,336	423	847	-
SF4B-H72<V2>, SF4B-A36<V2>	1,430	1,479	1,496	477	953	-
SF4B-H80<V2>, SF4B-A40<V2>	1,590	1,639	1,656	530	<b>1,060</b>	-
SF4B-H88<V2>, SF4B-A44<V2>	1,750	1,799	1,816	438	875	<b>1,313</b>
SF4B-H96<V2>, SF4B-A48<V2>	1,910	1,959	1,976	478	955	1,433

Type	G	H
SF4B-F□<V2>	10	5
SF4B-H□<V2>	20	5
SF4B-A□<V2>	40	15



#### ◆ NOTE

The intermediate supporting bracket (MS-SFB-2) is enclosed with the sensors.  
The number of the brackets varies depending on the sensor.



Model No.	A	J	K	L	M	N
SF4B-F71<V2>, SF4B-H36<V2>, SF4B-A18<V2>	710	689	681	-	-	-
SF4B-F79<V2>, SF4B-H40<V2>, SF4B-A20<V2>	790	769	761	370	-	-
SF4B-F95<V2>, SF4B-H48<V2>, SF4B-A24<V2>	950	929	921	450	-	-
SF4B-F111<V2>, SF4B-H56<V2>, SF4B-A28<V2>	1,110	1,089	1,081	530	-	-
SF4B-F127<V2>, SF4B-H64<V2>, SF4B-A32<V2>	1,270	1,249	1,241	398	822	-
SF4B-H72<V2>, SF4B-A36<V2>	1,430	1,409	1,401	452	928	-
SF4B-H80<V2>, SF4B-A40<V2>	1,590	1,569	1,561	505	<b>1,035</b>	-
SF4B-H88<V2>, SF4B-A44<V2>	1,750	1,729	1,721	413	850	<b>1,288</b>
SF4B-H96<V2>, SF4B-A48<V2>	1,910	1,889	1,881	453	930	1,408

Type	G	H
SF4B-F□<V2>	10	5
SF4B-H□<V2>	20	5
SF4B-A□<V2>	40	15



#### ◆ NOTE

The intermediate supporting bracket (MS-SFB-2) is enclosed with the sensors. The number of the brackets varies depending on the sensor.



Model No.	A	J	K	L	M	N
SF4B-F79<V2>, SF4B-H40<V2>, SF4B-A20<V2>	790	769	761	370	-	-
SF4B-F95<V2>, SF4B-H48<V2>, SF4B-A24<V2>	950	929	921	450	-	-
SF4B-F111<V2>, SF4B-H56<V2>, SF4B-A28<V2>	1,110	1,089	1,081	530	-	-
SF4B-F127<V2>, SF4B-H64<V2>, SF4B-A32<V2>	1,270	1,249	1,241	398	822	-
SF4B-H72<V2>, SF4B-A36<V2>	1,430	1,409	1,401	452	928	-
SF4B-H80<V2>, SF4B-A40<V2>	1,590	1,569	1,561	505	1,035	-
SF4B-H88<V2>, SF4B-A44<V2>	1,750	1,729	1,721	413	850	1,288
SF4B-H96<V2>, SF4B-A48<V2>	1,910	1,889	1,881	453	930	1,408

Type	G	H
SF4B-F□<V2>	10	5
SF4B-H□<V2>	20	5
SF4B-A□<V2>	40	15



#### ◆ NOTE

The intermediate supporting bracket (MS-SFB-2) is enclosed with the sensors. The number of the brackets varies depending on the sensor.





### 8.2.2 M8 360° Rotatable Mounting Bracket (MS-SFB-1-T)

The mounting bracket material is diecast zinc alloy.



### 8.2.3 Rear Mounting Bracket (MS-SFB-7-T)

The rear mounting bracket MS-SFB-7-T is also part of the rear / side mounting bracket set MS-SFB-1-T2. The mounting bracket material is cold-rolled carbon steel with trivalent chromate coating.

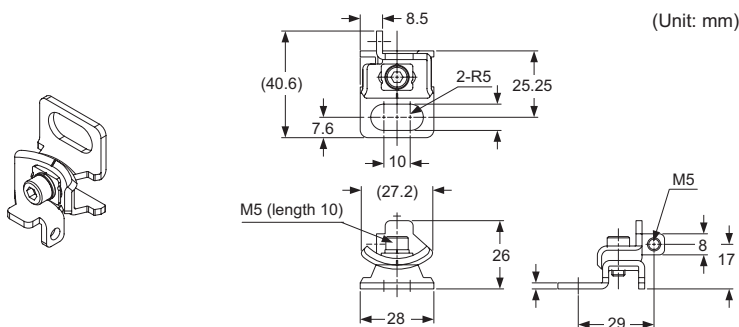

### 8.2.4 Side Mounting Bracket (MS-SFB-8-T)

There are two different side mounting brackets MS-SFB-8-T, one for the left side and one for the right side of the sensor. Both brackets are also part of the rear / side mounting bracket set MS-SFB-1-T2. The mounting bracket material is cold-rolled carbon steel with trivalent chromate coating.

(Unit: mm)

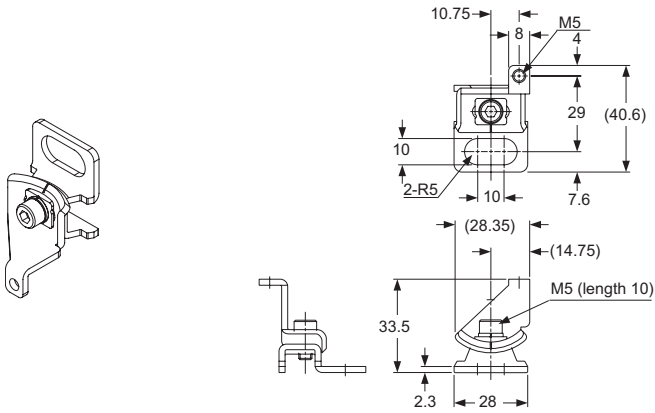

Left side mounting bracket

(Unit: mm)

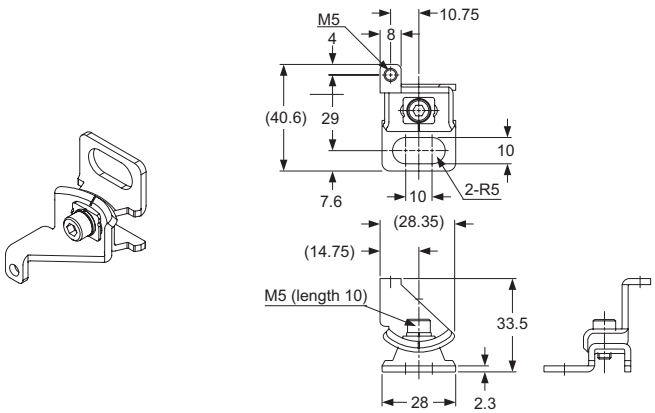

Right side mounting bracket

### 8.2.5 M5 Pitch Adapter Bracket (MS-SFB-4)

The mounting bracket material is diecast zinc alloy.

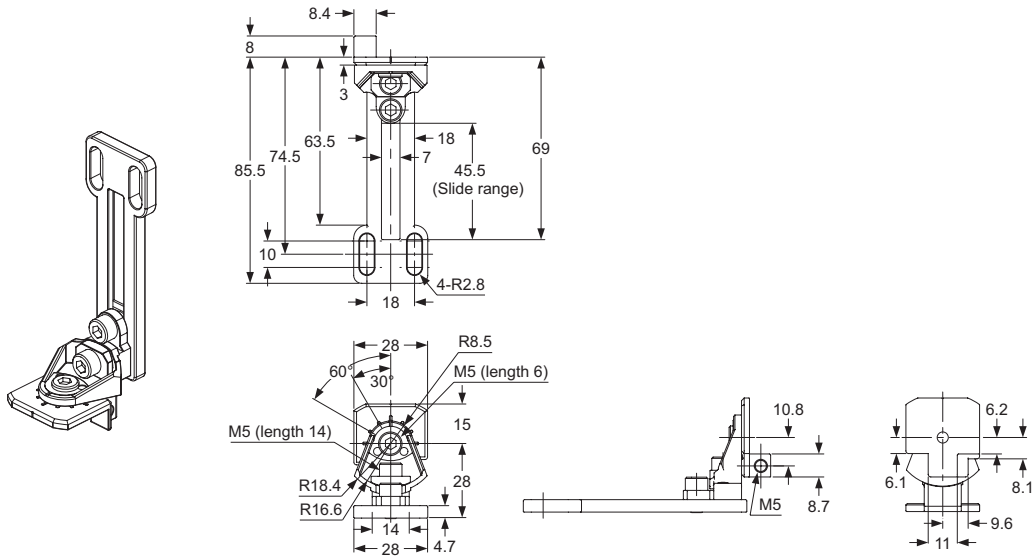

### 8.2.6 M8 Pitch Adapter Bracket (MS-SFB-4-T)

The mounting bracket material is diecast zinc alloy.

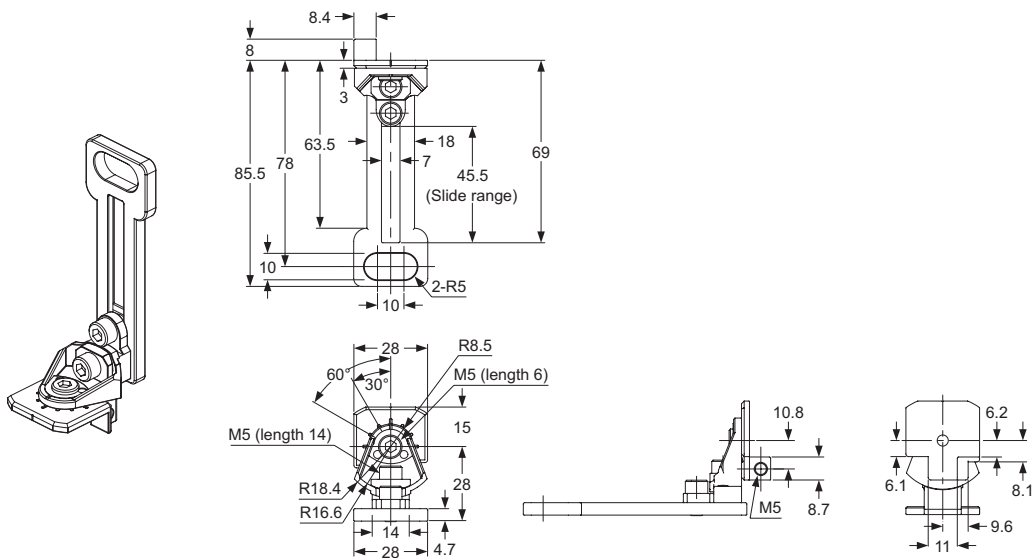

### 8.2.7 Intermediate Supporting Bracket (MS-SFB-2)

The mounting bracket material is diecast zinc alloy.

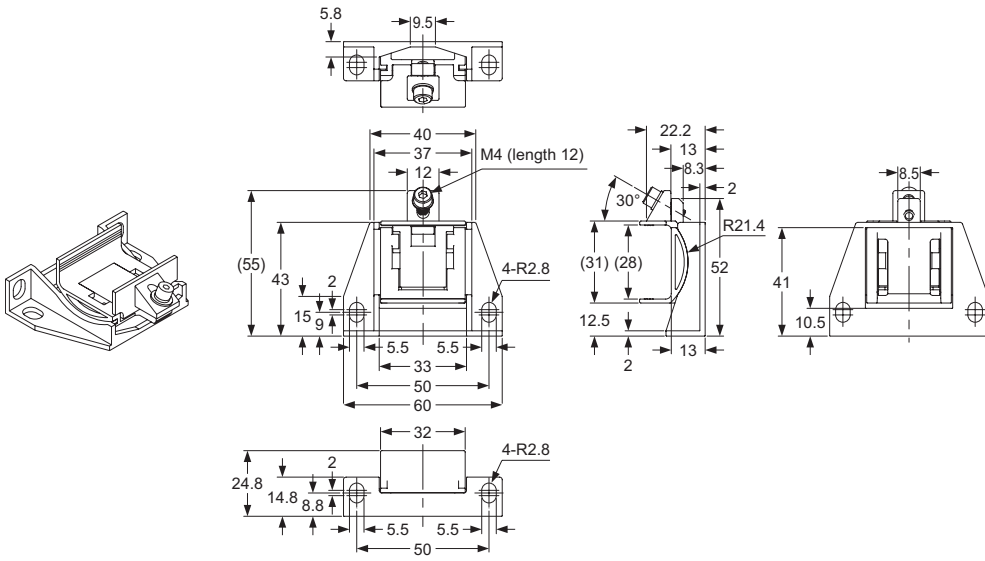

### 8.2.8 Dead Zoneless Mounting Bracket (MS-SFB-3)

The mounting bracket material is diecast zinc alloy.

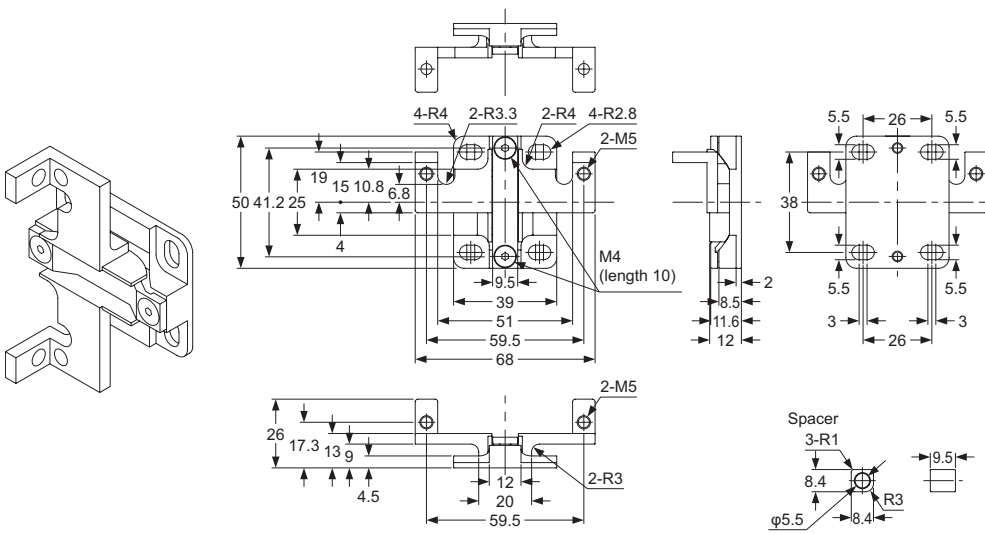

# Glossary of Terms

---

## **Control output (OSSD)**

Output Signal Switching Device. A component of the light curtain that turns off when light of the light curtain is blocked.

## **EMC Directive**

On the one hand, the directive relating to electromagnetic compatibility (EMC) governs the electromagnetic emissions of this equipment in order to ensure that, when used as intended, such equipment does not disturb radio, telecommunication or other equipment. On the other hand, the directive also governs the immunity of such equipment to ensure that this equipment is not disturbed by radio emissions normally present when used as intended.

## **Emission Halt Function**

This function enables receiver operation to be checked by turning OFF light emission. Light emission can be halted by keeping the emission halt input terminals between T1 and T2 of the controller open.

## **EN 55011**

This standard specifies the limits and methods of measurement of radio disturbance characteristics of industrial, scientific and medical (ISM) radio-frequency equipment.

## **EN 61496-1, IEC 61496-1/2, UL61496-1/2, JIS B 9704-1/2**

These standards pertain to machine safety, especially electro-sensitive protective equipment (ESPE). EN 61496-1, IEC 61496-1, UL 61496-1 or JIS B 9704-1 define general requirements, examinations and effect analysis, EMC requirements, etc. IEC 61496-2, UL 61496-2 or JIS B 9704-2 specifies effective aperture angle, protection against extraneous light sources, etc, for Active Opto-electronic Protective Devices (AOPDs).

## **ESPE**

Electro-Sensitive Protective Equipment.

## **FSD**

Final Switching Device. Additional relays between the outputs of the controller and the machinery.

## **ISO-13849-1 (JIS B 9705-1)**

This standard specifies the safety-related matters of machine safety (control system).

## **Lockout**

Lockout is one of the safe states of this device. Operation is stopped if the self-diagnosis function determines that an irrecoverable failure (OSSDs do not operate normally, etc.) has occurred. If an emitter is in the lockout condition, it will stop emitting light. If a receiver is in the lockout condition, the OSSDs are turned OFF.

**Machinery Directive**

"Machinery" means an assembly of linked parts or components, at least one of which moves, energized by electricity, compressed air, oil pressure, etc. The latest amendment to the directive introduces safety components, placed on the market separately, into its scope. These are defined as components which are placed on the market "to fulfill a safety function when in use and the failure or malfunctioning of which endangers the safety or health of exposed persons".

**Main system**

For series connection, the system that provides the power supply and output for all sub systems.

**PSDI**

Presence Sensing Device Initiation. The safety configuration that restarts automatically without any operation by the operator after the device detects the danger status and halts for a while.

**Safety distance**

The minimum distance that must be maintained between the light curtain and the dangerous parts of a machine so that the machine can be stopped before a human body or an object can reach the dangerous parts.

**Sensing height**

The sensing height is determined by the number of beam channels +10mm (+5mm at the bottom and +5mm at the top).

**Sub system**

See "Main system".

**Test rod**

This is a rod for checking the detection capability of this device. Its dimensions correspond to the minimum size of the object to be sensed by this device.

**UL1998**

UL standard for safety-related software in programmable components.

# Index

---

## 3

---

360° rotatable mounting bracket.....27, 131

## A

---

Accessories.....127

Alignment indicator ..... 11, 69, 114

Alignment tool .....134

Aperture angle .....24

Auto-reset.....62, 75, 76

## C

---

Calculation of safety distance .....16

Color codes.....34, 44

## D

---

Digital error indicator..... 11, 69, 113, 117

Display .....11

Distance .....25

## E

---

Emission halt function .....76, 99

Emission halt indicator .....11, 113

External device monitor function.....79

## F

---

Fault indicator ..... 11, 69, 112, 115

## H

---

Handy controller.....88, 134

## I

---

Inspection checklist.....106, 109

Installation .....15, 25, 27

Interference.....25, 54, 58

Interference prevention function .....77

Interlock function.....75

## M

---

Maintenance .....106, 108, 109

Manual reset .....75, 76

Maximum cable length.....44

Maximum response time.....16

Mounting procedure .....28

Muting function.....81

Muting lamp .....81

## N

---

Non-safety output.....78

## O

---

Operation indicator.....11, 114, 117

Options.....127

Override function.....85

## P

---

Pin assignment .....44

PSDI mode.....16

## R

---

Rear mounting .....144, 146

Rear mounting bracket.....27, 131, 132

Reflective surfaces.....24

## S

---

Safety instructions.....3

Safety relay unit .....75

Self-diagnosis function.....44, 74

Sensing area.....15



Sensing height .....	15
Sensing range .....	15
Sensor .....	119
Sensor Correct installation.....	15, 69
Sensor dismantling .....	36
Sensor extension in series connection ...	36
Sensor placement .....	25
Series and parallel connection .....	64
Series connection .....	36, 51, 130
Side mounting .....	142
Side mounting bracket .....	27, 131, 132
Specifications .....	124

---

**T**

Test .....	71
------------	----

---

**W**

Wiring with NPN output.....	42, 130
Wiring with PNP output.....	40, 130

## EC Declaration of Conformity

**We** SUNX Limited  
**of** 2431-1, Ushiyama-cho, Kasugai, Aichi 486-0901, Japan

**declare that:**

**Product** Active Opto-electronic Protective Device (Light Curtain)  
**Model name** SF4B Series  
**Trade name** SUNX

**in accordance with the following Directives:**

98/37/EC Machinery Directive (Valid until 29 December 2009)  
2006/42/EC Machinery Directive (Valid from 29 December 2009)  
2004/108/EC EMC Directive

**has been designed and manufactured to the following specifications:**

EN 61496-1 : 2004	IEC 61508-4: 1998
IEC 61496-2 : 2006	EN ISO 13849-1: 2008
IEC 61508-1: 1998	EN 50178 : 1997
IEC 61508-2: 2000	EN 55011 : 2007 +A2 :2007
IEC 61508-3: 1998	EN 61000-6-2: 2005

**I hereby declare that the product named above has been designed to comply with the relevant sections of the above referenced specifications. The product complies with all essential requirements of the Directives.**

### **Type Examination Certificate**

Certificate No. Z10 09 09 19003 036 (Date 17-September-2009)  
(by TÜV SÜD Product Service GmbH, Ridlerstrasse 65 80339 München Germany)

**Year of CE Marking : 2004**

**Issued on : 5-November-2009**

**Signed by the manufacturer :**

Takanobu Yada

**Name** : Takanobu Yada

**Position** : Divisional General Manager, Sensor Division

---

### **Contact :**

(Date) : 18. Nov. 2009  
(Signature) : C. Oehler  
(Printed name) : Christoph Oehler, Senior Manager IPS  
(Company name) : Panasonic Electric Works Europe AG  
(Address) : Rudolf-Diesel-Ring 2  
83607 Holzkirchen, Germany

We, Panasonic Electric Works SUNX Co., Ltd.  
of 2431-1, Ushiyama-cho, Kasugai, Aichi 486-0901, Japan

comprehensively declare, regardless of previous corporate name, trade name, brand name,  
and/or brand logo listed below:

The enclosed DoC remains unchanged valid unless it is revised with the present corporate  
name, trade name, brand name, and/or brand logo.

This declaration concerns the product at hand.

As from 1 October, 2010, corporate name, trade name, brand name, and brand logo are  
recognized as follows:

Corporate Name

Present:	Previous:
<b>Panasonic Electric Works SUNX Co., Ltd.</b>	<b>SUNX Limited</b>

Trade and Brand Name

Present:	Previous:
<b>Panasonic</b>	<b>SUNX</b>

Logo

Present:	Previous:
----------	-----------

**Panasonic** *SUNX*

Issued on: 1 October 2010



**North America**

**Europe**

**Asia Pacific**

**China**

**Japan**

## Panasonic Electric Works Global Sales Companies

### Europe

▶ <b>Headquarters</b>	<b>Panasonic Electric Works Europe AG</b>	Rudolf-Diesel-Ring 2, 83607 Holzkirchen, Tel. +49 (0) 8024 648-0, Fax +49 (0) 8024 648-111, <a href="http://www.panasonic-electric-works.com">www.panasonic-electric-works.com</a>
▶ <b>Austria</b>	<b>Panasonic Electric Works Austria GmbH</b> <b>PEW Electronic Materials Europe GmbH</b>	Rep. of PEWDE, Josef Madersperger Str. 2, 2362 Biedermansdorf, Tel. +43 (0) 2236-26846, Fax +43 (0) 2236-46133, <a href="http://www.panasonic-electric-works.at">www.panasonic-electric-works.at</a> Ennschafenstrasse 30, 4470 Enns, Tel. +43 (0) 7223 883, Fax +43 (0) 7223 88333, <a href="http://www.panasonic-electronic-materials.com">www.panasonic-electronic-materials.com</a>
▶ <b>Benelux</b>	<b>Panasonic Electric Works Sales Western Europe B.V.</b>	De Rijn 4, (Postbus 211), 5684 PJ Best, (5680 AE Best), Netherlands, Tel. +31 (0) 499 372727, Fax +31 (0) 499 372185, <a href="http://www.panasonic-electric-works.nl">www.panasonic-electric-works.nl</a>
▶ <b>Czech Republic</b>	<b>Panasonic Electric Works Czech s.r.o.</b>	Prumtyslova 1, 34815 Planá, Tel. (+420-)-374799990, Fax (+420-)-374799999, <a href="http://www.panasonic-electric-works.cz">www.panasonic-electric-works.cz</a>
▶ <b>France</b>	<b>Panasonic Electric Works Sales Western Europe B.V.</b>	Succursale française, 10, rue des petits ruisseaux, 91371 Verrières le Buisson, Tél. +33 (0) 1 6013 5757, Fax +33 (0) 1 6013 5758, <a href="http://www.panasonic-electric-works.fr">www.panasonic-electric-works.fr</a>
▶ <b>Germany</b>	<b>Panasonic Electric Works Europe AG</b>	Rudolf-Diesel-Ring 2, 83607 Holzkirchen, Tel. +49 (0) 8024 648-0, Fax +49 (0) 8024 648-111 <a href="http://www.panasonic-electric-works.de">www.panasonic-electric-works.de</a>
▶ <b>Hungary</b>	<b>Panasonic Electric Works Europe AG</b>	Magyarországi Közvetlen Kereskedelmi Képviselő, 1117 Budapest, Neumann János u. 1., Tel. +36(0)1482 9258, Fax +36 (0) 1482 9259, <a href="http://www.panasonic-electric-works.hu">www.panasonic-electric-works.hu</a>
▶ <b>Ireland</b>	<b>Panasonic Electric Works UK Ltd.</b>	Dublin, Tel. +353 (0) 14600969, Fax +353 (0) 14601131, <a href="http://www.panasonic-electric-works.co.uk">www.panasonic-electric-works.co.uk</a>
▶ <b>Italy</b>	<b>Panasonic Electric Works Italia s.r.l.</b>	Via del Commercio 3-5 (Z.I. Ferlina), 37012 Bussolengo (VR), Tel. +39 (0) 456752711, Fax +39 (0) 456700444, <a href="http://www.panasonic-electric-works.it">www.panasonic-electric-works.it</a>
▶ <b>Nordic Countries</b>	<b>Panasonic Electric Works Nordic AB</b> <b>PEW Fire &amp; Security Technology Europe AB</b>	Sjöängsvägen 10, 19272 Sollentuna, Sweden, Tel. +46 859476680, Fax +46 859476690, <a href="http://www.panasonic-electric-works.se">www.panasonic-electric-works.se</a> Jungmansgatan 12, 21119 Malmö, Tel. +46 40697-7000, Fax +46 40697-7099, <a href="http://www.panasonic-fire-security.com">www.panasonic-fire-security.com</a>
▶ <b>Poland</b>	<b>Panasonic Electric Works Polska sp. z o.o.</b>	Al. Krakowska 4/6, 02-284 Warszawa, Tel. +48 (0) 22 338-11-33, Fax +48 (0) 22 338-12-00, <a href="http://www.panasonic-electric-works.pl">www.panasonic-electric-works.pl</a>
▶ <b>Portugal</b>	<b>Panasonic Electric Works España S.A.</b>	Portuguese Branch Office, Avda Adelino Amaro da Costa 728 R/C J, 2750-277 Cascais, Tel. +351 214812520, Fax +351 214812529
▶ <b>Spain</b>	<b>Panasonic Electric Works España S.A.</b>	Barajas Park, San Severo 20, 28042 Madrid, Tel. +34 913293875, Fax +34 913292976, <a href="http://www.panasonic-electric-works.es">www.panasonic-electric-works.es</a>
▶ <b>Switzerland</b>	<b>Panasonic Electric Works Schweiz AG</b>	Grundstrasse 8, 6343 Rotkreuz, Tel. +41 (0) 417997050, Fax +41 (0) 417997055, <a href="http://www.panasonic-electric-works.ch">www.panasonic-electric-works.ch</a>
▶ <b>United Kingdom</b>	<b>Panasonic Electric Works UK Ltd.</b>	Sunrise Parkway, Linford Wood, Milton Keynes, MK14 6LF, Tel. +44(0) 1908 231555, +44(0) 1908 231599, <a href="http://www.panasonic-electric-works.co.uk">www.panasonic-electric-works.co.uk</a>

### North & South America

▶ <b>USA</b>	<b>PEW Corporation of America</b>	629 Central Avenue, New Providence, N.J. 07974, Tel. +1-908-464-3550, Fax +1-908-464-8513, <a href="http://www.pewa.panasonic.com">www.pewa.panasonic.com</a>
--------------	-----------------------------------	---

### Asia Pacific/China/Japan

▶ <b>China</b>	<b>Panasonic Electric Works (China) Co., Ltd.</b>	Level 2, Tower W3, The Tower Oriental Plaza, No. 2, East Chang An Ave., Dong Cheng District, Beijing 100738, Tel. (010) 5925-5988, Fax (010) 5925-5973, <a href="http://www.pewc.panasonic.cn">www.pewc.panasonic.cn</a>
▶ <b>Hong Kong</b>	<b>Panasonic Electric Works (Hong Kong) Co., Ltd.</b>	RM1205-9, 12/F, Tower 2, The Gateway, 25 Canton Road, Tsimshatsui, Kowloon, Hong Kong, Tel. (8520) 2956-3118, Fax (0852) 2956-0398
▶ <b>Japan</b>	<b>Panasonic Electric Works Co., Ltd.</b>	1048 Kadoma, Kadoma-shi, Osaka 571-8686, Japan, Tel. (06)-6908-1050, Fax (06)-6908-5781 <a href="http://panasonic-electric-works.net">http://panasonic-electric-works.net</a>
▶ <b>Singapore</b>	<b>Panasonic Electric Works Asia Pacific Pte. Ltd.</b>	101 Thomson Road, #25-03/05, United Square, Singapore 307591, Tel. (06255)-5473, Fax (06253)-5689